



SECOND EDITION

AIRPORT DESIGN AND OPERATION



Antonín Kazda • Robert E. Caves

AIRPORT DESIGN AND OPERATION

Second Edition

Related Books

ANNE GRAHAM	Managing Airports
CHRISTOPHER BLOW	Transport Terminals and Modal Interchanges
DARIN LEE	Advances in Airline Economics, I
MARTIN DRESNER	Research in Transportation Economics
DAVID A. HENSHER	Handbooks in Transport 6

Related Journals

Transportation Research Part E: Logistics and Transportation Review

Journal of Air Transport Management



AIRPORT DESIGN AND OPERATION

Second Edition

ANTONÍN KAZDA

University of Žilina, Slovakia

ROBERT E. CAVES

Loughborough University, U.K.



ELSEVIER

Amsterdam – Boston – Heidelberg – London – New York – Oxford – Paris
San Diego – San Francisco – Singapore – Sydney – Tokyo

Elsevier
Linacre House, Jordan Hill, Oxford OX2 8DP, U.K.
Radarweg 29, PO Box 211, 1000 AE Amsterdam, The Netherlands

First edition 2007

Copyright © 2007 Elsevier Ltd. All rights reserved

No part of this publication may be reproduced, stored in a retrieval system or transmitted in any form or by any means electronic, mechanical, photocopying, recording or otherwise without the prior written permission of the publisher

Permissions may be sought directly from Elsevier's Science & Technology Rights Department in Oxford, UK: phone (+44) (0) 1865 843830; fax (+44) (0) 1865 853333; email: permissions@elsevier.com. Alternatively you can submit your request online by visiting the Elsevier web site at <http://elsevier.com/locate/permissions>, and selecting *Obtaining permission to use Elsevier material*

Notice

No responsibility is assumed by the publisher for any injury and/or damage to persons or property as a matter of products liability, negligence or otherwise, or from any use or operation of any methods, products, instructions or ideas contained in the material herein. Because of rapid advances in the medical sciences, in particular, independent verification of diagnoses and drug dosages should be made

British Library Cataloguing in Publication Data

A catalogue record for this book is available from the British Library

Library of Congress Cataloging-in-Publication Data

A catalog record for this book is available from the Library of Congress

ISBN-13: 978-0-08-045104-6

For information on all Elsevier publications
visit our website at books.elsevier.com

Printed and bound in The United Kingdom

07 08 09 10 11 10 9 8 7 6 5 4 3 2 1

Working together to grow
libraries in developing countries

www.elsevier.com | www.bookaid.org | www.sabre.org

ELSEVIER

BOOK AID
International

Sabre Foundation

Dedication

We have written this book for all the fools who love the beautiful fragrance of the burnt kerosene.

Tony Kazda and Bob Caves

We would like to thank our wives for their understanding during our writing, because the time involved for this work was stolen from our families. Also we thank 'little' Zuzana and Tom for their help with language and the manipulation of computer software. We appreciate all the help from the professionals who have contributed to the text or have given freely their time and expertise to advise and correct our draft texts.

This page intentionally left blank

CONTENTS

Preface	xv
1 AIR TRANSPORT AND AIRPORTS.....	1
1.1 Development of Airports	1
1.2 Standards.....	13
1.2.1 ICAO Legislation.....	13
1.2.2 National Standards and Recommended Practices	16
1.3 Airport Development Planning	16
2 PREDICTING TRAFFIC.....	21
2.1 Introduction.....	21
2.2 Types of Forecast Needed.....	22
2.3 Methods of Analysis	23
2.3.1 Informed Judgement.....	23
2.3.2 Trend Extrapolation.....	24
2.3.3 Econometric Models.....	26
2.3.4 The Travel Decisions.....	28
2.3.5 Modal Shares	29
2.3.6 Discrete Choice Models	30
2.3.7 Revealed and Stated Preferences.....	31
2.3.8 Effects of Supply Decisions	32
2.3.9 Uncertainty	32
2.3.10 Scenario Writing.....	34
2.4 Historic Trends in Traffic	35
2.5 Factors Affecting the Trends.....	36
2.5.1 Economic Factors	36
2.5.2 Demographic Factors	36
2.5.3 Supply Factors.....	37
2.5.4 Economic Regulation	40
2.5.5 Environmental Regulation.....	40
2.5.6 Cargo	40
2.6 Conclusions.....	41
3 AIRPORT SITE SELECTION AND RUNWAY SYSTEM ORIENTATION.....	45
3.1 Selection of a Site for the Airport	45
3.2 Usability Factor.....	47

3.3	Low Visibility Operations.....	50
3.4	Control of Obstacles.....	58
3.5	Other Factors.....	65
4	RUNWAYS	69
4.1	Aerodrome Reference Code.....	69
4.2	Runway Length.....	73
4.3	Declared Distances.....	88
4.4	Runway Width.....	90
4.4.1	Runway Width Requirements.....	90
4.4.2	Runway Shoulders.....	91
4.4.3	Runway Turn Pads.....	92
4.5	Runway Slopes.....	93
4.5.1	Transverse Slopes.....	93
4.5.2	Longitudinal Slopes.....	94
5	RUNWAY STRIPS AND OTHER AREAS	97
5.1	Runway Strips.....	97
5.2	Clearways.....	100
5.3	Runway End Safety Areas.....	101
6	TAXIWAYS	107
6.1	Taxiway System Design.....	107
6.2	High-speed Exit Taxiways.....	108
6.3	Taxiway Separations.....	113
6.4	Taxiway Geometry.....	115
7	APRONS.....	119
7.1	Apron Requirements.....	119
7.2	Apron Sizing.....	121
7.3	Apron Location.....	122
7.4	Apron Concepts.....	124
7.4.1	Simple Concept.....	124
7.4.2	Linear Concept.....	124
7.4.3	Open Concept.....	125
7.4.4	Pier Concept.....	126
7.4.5	Satellite Concept.....	128
7.4.6	Hybrid Concept.....	128
7.5	Stand Types.....	129
7.6	Apron Capacity.....	135
7.7	Isolated Aircraft Parking Position.....	136

8 PAVEMENTS	137
8.1 Background.....	137
8.2 Pavement Types.....	138
8.2.1 Non-Reinforced Grass Strips.....	139
8.2.2 Reinforced Grass Strips.....	139
8.2.3 Reinforced Pavements with Hard Surface.....	140
8.2.3.1 Use of Hard Surface Pavements.....	140
8.2.3.1.1 Subgrade.....	141
8.2.3.1.2 Sub-base.....	142
8.2.3.1.3 Bearing Course.....	142
8.2.3.2 Flexible (Asphalt) Pavements.....	142
8.2.3.3 Rigid (Cement-concrete) Pavements.....	144
8.2.3.4 Combined Pavements.....	151
8.2.3.5 Block Paving.....	151
8.3 Pavement Strength.....	151
8.3.1 Pavements-Aircraft Loads.....	151
8.3.2 Pavement Strength Reporting.....	153
8.3.3 Overload Operations.....	157
8.4 Runway Surface.....	158
8.4.1 Runway Surface Quality Requirements.....	158
8.4.2 Methods of Runway Surface Unevenness Assessment by the Dual Mass Method.....	159
8.4.3 Pavement Texture.....	163
8.4.4 Runway Braking Action.....	166
8.5 Pavement Management System.....	171
9 AIRCRAFT GROUND HANDLING	173
9.1 Aircraft Handling Methods and Safety.....	173
9.2 Aircraft Ground Handling Activities.....	180
9.2.1 Deplaning and Boarding.....	180
9.2.2 Supplies of Power, Air-Conditioning and Compressed Air.....	183
9.2.3 Cargo and Baggage Loading.....	184
9.2.4 Push Back Operations.....	184
9.3 Collaborative Decision Making (CDM).....	188
9.4 Visual Guidance Systems.....	190
10 AIRCRAFT REFUELLING	197
10.1 Background.....	197
10.2 Fuel - Requirements.....	199
10.2.1 Requirements for Fuel Quality.....	199
10.2.2 Fuel Storage.....	201
10.3 Fuel Distribution.....	204
10.4 Safety of the Refuelling Operation.....	208
10.4.1 Ecological Damage.....	208

10.4.2 Fire Safety 211
 10.5 Aircraft Fuel - Future Trends 212

11 CARGO 213

11.1 Introduction 213
 11.2 The Freight Industry’s Characteristics 217
 11.3 Airside Design Considerations 221
 11.4 Terminal Design and Operating Considerations 223
 11.4.1 Location 223
 11.4.2 Design parameters 224
 11.4.3 Mechanisation 225
 11.4.4 Terminal functions and operations 226
 11.4.5 Documentation 228
 11.4.6 Utilities 230
 11.4.7 Security 231
 11.5 Cargo Terminal Layout and Sizing 232
 11.5.1 Layout 232
 11.5.2 Functions and facilities 233
 11.5.3 Sizing 234
 11.6 Landside Design and Operations 237
 11.7 Future Trends 237
 11.8 DHL Case Study 238

12 PASSENGER TERMINALS 241

12.1 Airport Terminal Design Principles 241
 12.2 Airport Terminal Layout 246
 12.3 Airport Terminal Concepts 249
 12.4 Terminal Design 251
 12.4.1 Design Methods 251
 12.4.2 Component Design 255
 12.5 The Handling Process 265
 12.5.1 Passenger Handling 265
 12.5.2 Baggage Handling 273
 12.6 Non-Aeronautical Services 274
 12.7 Passenger Transportation - People Movers 276

13 SECURITY 281

13.1 Unlawful Acts and Air Transport 281
 13.2 The Airport System and its Security 287
 13.3 Safeguarding of Airport Security 290
 13.3.1 Security as a Service 290
 13.3.2 Airport Perimeter Security and Staff Identification 291
 13.3.3 Employee Security Procedures 296
 13.3.4 Measures in Relation to Passengers 298

13.4	Detection of Dangerous Objects	303
13.5	Summary	310
14	LANDSIDE ACCESS.....	311
14.1	Access and the Airport System	311
14.2	Selection of the Access Modes	314
14.3	Categories of Surface Transport Users	315
14.4	Access and Terminal Operations	316
14.5	Access Modes	317
14.5.1	Passenger Car	317
14.5.2	Taxi.....	319
14.5.3	Minibus.....	320
14.5.4	Bus.....	321
14.5.5	Railway Transport	322
14.5.6	Unconventional Means of Transport.....	327
15	VISUAL AIDS FOR NAVIGATION.....	329
15.1	Markings	329
15.1.1	Markings Requirements	329
15.1.2	Marking Types	333
15.1.3	Signs	335
15.2	Airport Lights <i>(Author: František Bělohradský, Consultant, Prague, CZ)</i>	336
15.2.1	Characteristics and Components of Airport Lighting Systems	336
15.2.1.1	Introduction	336
15.2.1.2	Light Sources.....	337
15.2.1.3	Lights and Fittings.....	338
15.2.1.4	Frangible Safety Masts.....	340
15.2.1.5	Requirements for Aerodrome Lights.....	340
15.2.2	Characteristics and Components of Airport Lighting Systems	343
15.2.2.1	Approach and Runway Systems.....	343
15.2.2.1.1	Non-Instrument and Instrument Runways	343
15.2.2.1.2	Precision Approach Runway.....	345
15.2.2.2	Approach Slope Indicator Systems	352
15.2.2.3	Heliport Lighting Systems.....	357
15.2.4	Lighting of Obstacles	359
15.2.5	Light Control	361
15.2.5.1	Remote Control Equipment.....	361
15.2.5.2	Single Lamp Control and Monitoring	362
15.2.6	Lighting Systems Construction and Operation	364
15.2.6.1	Lighting Systems Design and Installation.....	364
15.2.6.2	Maintenance of the Lighting Systems	365
15.2.7	Trends in Lighting Systems Development	368

16 ELECTRICAL ENERGY SUPPLY	369
16.1 Background	369
16.2 Electrical Systems Reliability and Back-up.....	369
16.3 Supply Systems	376
16.3.1 Parallel System.....	376
16.3.2 Serial System.....	377
16.3.2.1 Serial System – the Principle.....	377
16.3.2.2 Serial System – Components.....	377
16.4 Electrical supply to Category I - III Lighting Systems	382
17 RADIO NAVIGATION AIDS.....	383
17.1 Background	383
17.2 Radio Navigation Aids.....	384
17.2.1 Instrument Landing System (ILS).....	384
17.2.2 Microwave Landing System (MLS).....	389
17.2.3 Global Navigation Satellite System (GNSS).....	390
17.2.4 VHF Omnidirectional Radio Range (VOR).....	391
17.2.5 Non-directional Radio Beacon (NDB).....	393
17.2.6 Distance Measuring Equipment (DME).....	394
17.2.7 Transponder Landing System (TLS).....	395
17.3 Radar Systems.....	395
17.3.1 Precision Approach Radar (PAR).....	395
17.3.2 Surveillance Radar Element (SRE).....	396
17.3.3 Surface Movement Radar (SMR).....	396
17.3.4 Advanced Surface Movement and Guidance Control Systems (A-SMGCS).....	396
17.4 Flight Inspections and Calibrations	398
18 AIRPORT WINTER OPERATION.....	401
18.1 Snow and Aircraft Operation	401
18.2 Snow Plan	403
18.3 Mechanical Equipment for Snow Removal and Ice Control	407
18.4 Chemicals for Runway De-icing.....	413
18.5 Thermal De-icing.....	417
18.6 Runway Surface Monitoring.....	419
18.7 Aircraft De-icing	420
19 AIRPORT EMERGENCY SERVICES	427
19.1 Roles of the Rescue and Fire Fighting Service	427
19.2 Level of Protection Required	428
19.2.1 Response Times.....	428
19.2.2 Aerodrome Category for Rescue and Fire Fighting	431
19.2.3 Principal Extinguishing Agents.....	432
19.2.4 Complementary Extinguishing Agents	434
19.2.5 The Amounts of Extinguishing Agents	435

19.3	Rescue and Fire Fighting Vehicles	437
19.4	Airport Fire Stations.....	441
19.5	Emergency Training and Activity of Rescue and Fire Fighting Unit.....	444
19.5.1	Training.....	444
19.5.2	Preparation for an Emergency Situation and Rescue and Fire Fighting Intervention Control.....	446
19.6	Runway Foaming	449
19.7	Post Emergency Operations.....	451
19.8	Emergency Services and Environment Protection.....	454
19.9	Final Thoughts	455
20	ENVIRONMENTAL CONTROL	457
20.1	Background.....	457
20.2	Noise (<i>Author: Milan Kamenický, Bratislava, Slovakia</i>).....	460
20.2.1	Characteristics	460
20.2.2	Descriptors Used for Aircraft Noise Rating	462
20.2.3	Evaluation of Noise in the Vicinity of Airports	467
20.2.4	Land Use and Compatibility Planning	470
20.2.5	Aircraft Noise Measurement	473
20.2.5.1	Short Term Measurement.....	474
20.2.5.2	Long-term Noise Monitoring	475
20.2.6	Prediction of Air Transport Noise.....	478
20.2.7	Airport Noise Mitigation and Noise Abatement Procedures	483
20.3	Control of Gaseous Emissions	485
20.4	Protection of Water Sources	487
20.5	Landscaping	488
20.6	Waste Management.....	489
20.7	Bird Control	490
20.7.1	Introduction	490
20.7.2	Bird Strike Statistics.....	491
20.7.3	Change of the Habitat.....	493
20.7.4	Bird Scaring.....	495
20.7.5	Ornithological Protection Zones	499
	Bibliography.....	501
	Index	517

This page intentionally left blank

PREFACE

This book is titled ‘Airport design and operation’. However, the reader will not find chapters devoted exclusively to airport design or airport operation. Airport design and airport operation are closely related and influence each other. A poor design affects the airport operation and results in increasing costs. On the other hand it is difficult to design the airport infrastructure without sound knowledge of the airport operation. This is emphasized throughout the book.

The book does not offer a set of simple instructions for solutions to particular problems. Every airport is unique and a simple generic solution does not exist. Some of the differences that relate to the political and economic situations in Eastern and Western Europe are reflected here. The book explains principles and relationships important for the design of airport facilities, for airport management and for the safe and efficient control of operations. We hope that we have been able to overcome the traditional view that an airport is only the runway and tarmac. An airport is a complex system of facilities and often the most important enterprise of a region. It is an economic generator and catalyst in its catchment area. However, this book is focused on one narrow part of the airport problem, namely design and operation, while bearing the other aspects in mind.

This second edition includes some important changes in the international regulations covering design and operations. It reflects the greater attention being given to security, safety and the environment, together with changes in the technology and the way the air transport industry operates. New sections on collaborative decision making and low visibility operations strengthen the operational content of this book. Two completely new chapters have been added covering the topical problems of cargo and radio –navigation aids and the chapter on passenger terminals has been enhanced considerably.

Tony Kazda and Bob Caves

Zilina, Slovakia and Loughborough UK, April 2007

This page intentionally left blank

1

AIR TRANSPORT AND AIRPORTS

Tony Kazda and Bob Caves

1.1 DEVELOPMENT OF AIRPORTS

First, consider the well-known question: ‘Which came first?’ In the context of this book, it does not refer to the notorious problem about a chicken and an egg, but about an airport and an aeroplane. In fact, the answer is clear. The aeroplane came first. When aviation was in its infancy, the aviator first constructed an aeroplane, and then began to search for a suitable ‘airfield’, where he could test the machine. The aerodrome parameters had to be selected on the basis of performance and geometrical characteristics of the aircraft. That trend to accommodate the needs of the aircraft prevailed, with some notable exceptions like New York’s La Guardia airport, until the end of the 1970s. This was despite the increasing requirements for strength of pavements, width and length of runways and other physical characteristics and equipment of aerodromes. The aerodromes always had to adapt to the needs of the aircraft.

The first aeroplanes were light, with a tail wheel, and the engine power was usually low. A mowed meadow with good water drainage was sufficient as an aerodrome for those aeroplanes. The difficulty in controlling the flight path of these aeroplanes required the surrounding airspace to be free of obstacles over a relatively wide area. Since the first aeroplanes were very sensitive to cross wind, the principal requirement was to allow taking off and landing always to be into wind. In the majority of cases, the aerodrome used to be square or circular without the runway being marked

2 *Airport Design and Operation*

out. The wind direction indicator that was so necessary in those days still has to be installed at every aerodrome today, though its use now at big international airports is less obvious. Other visual aids that date from that period are the landing direction indicator and the boundary markers.

The latter aid determined unambiguously where the field was, and where the aerodrome was, this flight information for the pilot not always being evident in the terrain.

Immediately after World War I in 1919-1920, the first air carriers opened regular air services between Paris and London, Amsterdam and London, Prague and Paris, among others. However, in that period no noticeable changes occurred in the airport equipment, or in the basic operating concept, other than some simple building for the processing of passengers and hangars for working on the aeroplanes.

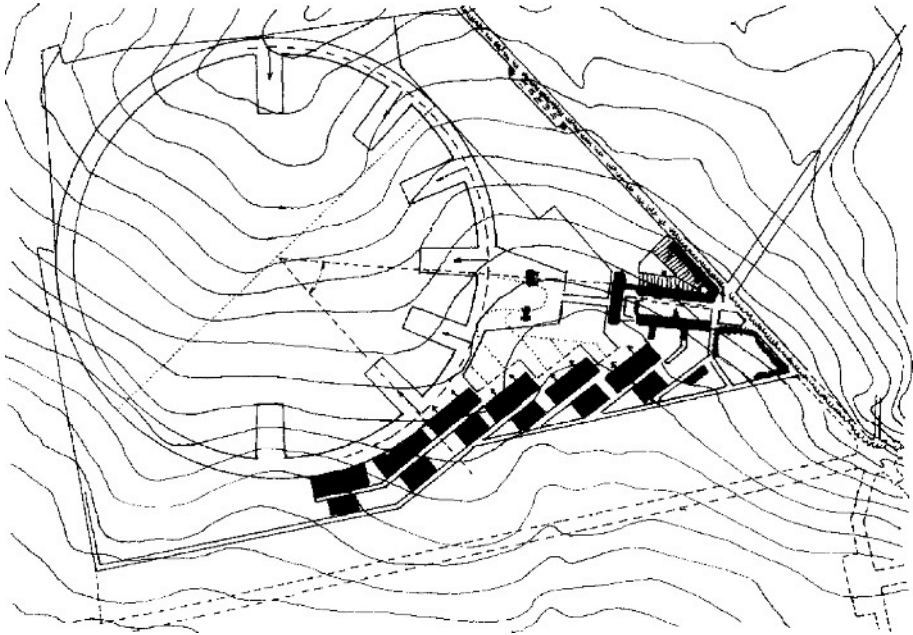

Figure 1-1 *The second prize winner in a competition in 1931 for the design of Prahá-Ruzyně airport development; (Source: Czech Airports Authority)*

Even in the 1930s, the new technology of the Douglas DC-2 and DC-3, which were first put into airline service in 1934 and 1936 respectively, was not sufficiently different to require large changes in the physical characteristics of aerodromes, so the development of airports up to that period may be characterised as gradual. The first passengers on scheduled airlines were mostly business people or the rich and famous, but this was a small scale activity, most of the flying being

done by the military. The main change in the airfield's physical characteristics was the runway length. The multiengine aircraft required the length to increase to approximately 1 000 m.

The increasing number of aircraft, and the training of the military pilots required more support facilities at airfields, such as hangars, workshops and barracks.

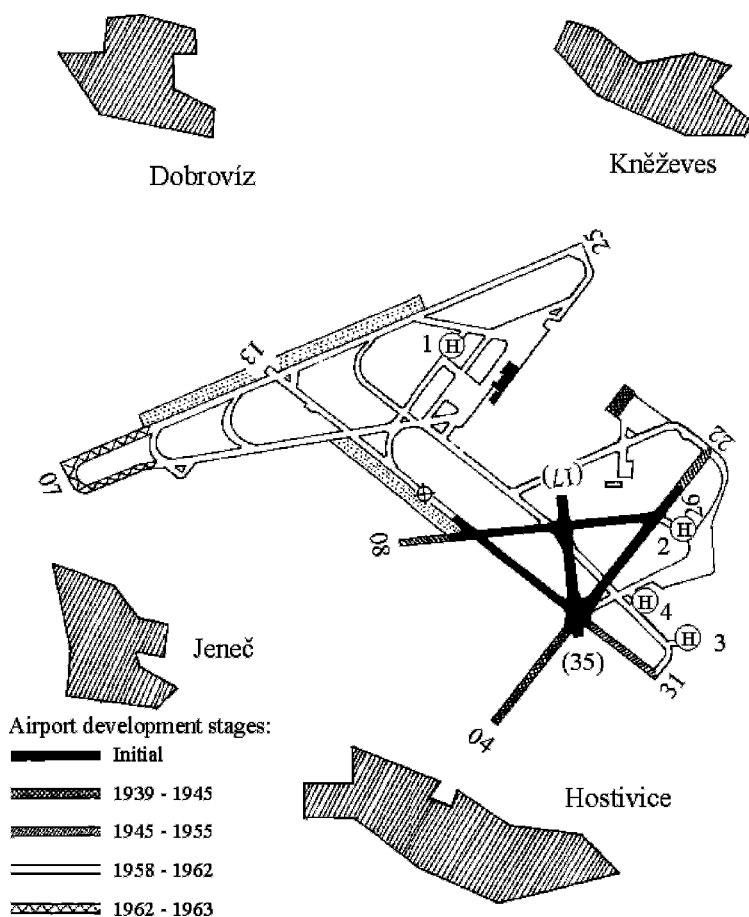

Figure 1-2 Development of Praha-Ruzyně runway system
 (Source: J. Čihař, *Letiště a jejich zařízení I.*, Alfa Bratislava 1973)

War does not benefit mankind but, for aviation, it has always meant a rapid step change in development. After World War II, there were unusually favourable conditions for the development of civil aviation and air transport. On one hand there were damaged ground communications, while on the other hand, there were plenty of surplus former military aircraft. There was also the

4 *Airport Design and Operation*

requirement to support the supply chains from the USA to Latin America, to Japan and to Europe under the Marshall Plan. All of that activity allowed civil air transport to recover quickly and then to continue to a higher level than before World War II. The requirements for aerodromes changed dramatically in that same short period of time.

The new aircraft required paved runways, partly because they were heavier and partly because regularity of service became more important. However, they were still relatively sensitive to the crosswind, despite having nose-wheel steering. Therefore the big international airports adopted a complicated system of between three and six runways in different directions in order to provide sufficient operational usability from the entire runway system. The large number of runways often reduced the amount of land available for further development of the airport. One of the runways, most often the runway in the direction of the prevailing winds, was gradually equipped with airport visual aids, thus being regarded as the main runway. At the same time terminal facilities were constructed which, besides the services required for the processing of passengers and their baggage, provided also the first non-aeronautical services, such as restaurants, toilets, and duty free shops.

The next substantial change that significantly influenced the development of airports was the introduction of aircraft with jet propulsion.

Jet aircraft required further extension of the runway, together with increases in its width and upgrading its strength. The operation of jet aeroplanes had an effect also upon other equipment and technical facilities of the airport. One of them was the fuel supply system. Not only did the fuel type change from gasoline to kerosene, but also the volume per aircraft increased considerably, requiring reconstruction of the fuel farms and the introduction of new refuelling technologies.

The introduction of the first wide body jet aircraft, the Boeing B 747-100 in 1970, had a large impact on the design of terminals. Before the B747-100, the runway or apron were limiting capacity factors for some airports but, after it was introduced, the terminal building capacity became critical. The B 747-100 capacity could replace two or three existing aircraft. Thus the number of aircraft movements was relatively reduced, and the number of passengers per movement increased. The B 747-100 required a further increase in the strength of manoeuvring areas, the enlargement of stands, and other changes such as to airport visual aids which resulted from the greater height of the cockpit giving a different view from the cockpit during approach and landing.

The B 747-100 in fact symbolized a whole new era of widebody air transport, as well as causing the system to adapt to it. At the same time, it signified that there had to be a limit to which airports could adapt fully to whatever the cutting edge of aircraft technology demanded of them. Not only was there a reaction from the international airport community. The manufacturers themselves

came to realize that if they constructed an aeroplane with parameters requiring substantial changes of ground equipment, they would find it difficult to sell it in the marketplace. Futuristic studies of new aircraft in the early 1980s, with a capacity of 700-1000 seats were not taken beyond the paper stage, partly for this reason as well as because the airlines had found it hard to sell all the capacity offered by the 747. Following this argument, the Boeing B 777-200 was designed with folding wingtips, though this option has not yet been taken up by any airline. The Airbus A 380 was designed to fit into an 80 m box which the airport industry regarded as the maximum it could cope with economically. Although some of the most recent airports like that at Hong Kong have been designed to cope with the introduction of the A380, so that only minor changes like the location of airside signs has been necessary, the airports which were originally designed around the needs of piston-engine aircraft have had to make very substantial changes to accept it. London's Heathrow airport has lost more than 20 stands due to having to increase taxiway separations and has had to build a new pier, the total cost being £450 million. Airbus A380 will also have a considerable impact on airport terminal operations. In the future the Airbus A380 will be able to carry up to about 850 passengers, though it will be limited to 550 passengers when it enters service in 2007.

Most recent changes to airports have not been provoked by new aircraft technology, but by political and economic developments. The airport situation in Europe has changed considerably since the 1960s. The airport in the past was a 'shop-window' of the state, and together with the national flag carrier, also an instrument to enforce state policy. After the successful corporatisation and then the privatisation of the British Airport Authority and some other airports, many governments have gradually changed their policy towards airports, particularly in regard to subsidy.

The following important factors influenced the entire development of airports from 1975 to 1992:

1. The threat of terrorism and a fear of unlawful acts.
2. The privatisation of airports.
3. The progressive deregulation of air transport.
4. The increasing environmental impact around airports.

The threat of terrorism, and in particular the bomb attack against the B 747 Pan-Am Flight 103 on 23rd December 1988 near Lockerbie in Scotland, subsequently required expensive changes of airport terminal buildings with a consistent separation of the arriving and departing passengers and installation of technical equipment for detecting explosives. The security problems are discussed in detail in Chapter 13 – Security.

The privatisation of airports started in Great Britain in 1986, and represented a fundamental change in the manner of administering and financing the airports in Europe. It was and still is seen almost

by most people as a success, though there are those, particularly in the USA, who believe that the emphasis on commercial viability has made it difficult to concentrate on an airport's main function of providing an effective and efficient transfer between air and ground transport. It has, though, resulted in a considerable extension and improvement of the services provided, particularly for the passengers and other visitors of the airport.

The deregulation that began in the USA in 1978 produced a revolution in the development of that industry. Up to then, air transport had been developing in an ordered fashion. Deregulation represented a free, unlimited access to the market, without any capacity and price limitations, unblocking the previously stringent regulation of the market in the United States. The percentage of the population who had never before travelled by plane reduced from 70 % to 20 %. However, it also brought about negative consequences for airport capacity due to the concentration of traffic at the major hubs and due to the gradual creation of extremely large airlines with the features of strong monopolies.

Table 1-1 World airports ranking by total passengers – 2005 data

Rank	Airport	Total Passengers (millions)	% Change on 2004
1	Atlanta (ATL)	85.9	2.8
2	Chicago (ORD)	76.5	1.3
3	Heathrow (LHR)	67.9	0.8
4	Tokio (HND)	63.3	1.6
5	Los Angeles (LAX)	61.5	1.3
6	Dallas/Fort Worth (DFW)	59.2	-0.4
7	Paris (CDG)	53.8	5.0
8	Frankfurt/Main (FRA)	52.2	2.2
9	Amsterdam (AMS)	44.2	3.8
10	Las Vegas (LAS)	44.0	6.0

Total Passengers: Arriving + departing passengers + direct transit passengers counted once.

(Source: Airports Council International Traffic Data)

Therefore in Europe deregulation was approached with considerable caution, to the extent that the term 'liberalisation' has been adopted for the policy. The first measures to affect the major airlines

were adopted by the states of the European Twelve in 1988, though some countries had entered into liberal bilateral agreements as early as 1984. The measures referred in particular to the determination of tariffs and the shares of route capacity. They allowed more flexibility and easier access to the market when certain requirements were fulfilled, free access for aircraft of up to 70 seats and conferment of the Fifth Air Freedom within the states of the European Community.

The rate of growth of air transport worldwide since 1990 was strong. The volume of passengers in regular air transport doubled in the period from 1990 to 2000, and in the region of the Pacific Basin it even quadrupled. The air space in Europe became seriously congested. Airspace slots, into which a flight can be accepted by prior arrangement, became scarce. The queues of aeroplanes lengthened, both on the ground and in the air. The costs incurred by delayed flights reach annually USD hundreds of millions.

Besides the need of funding for reconstruction and the building of new terminals, the biggest problem for many large USA and European airports is the lack of capacity of the runway system, leading to a requirement for new runway construction. This is accentuated by the development of regional transport which will continue throughout Europe, despite the EC's preference for rail travel. Regional transport serves mostly business trips or to feed long haul flights, thereby increasing the demand for capacity of runway systems during the peak hour. According to the International Civil Aviation Organisation (ICAO), 16 European airports had insufficient capacity in the year 2000. It is impossible to adopt a quick and effective solution in Europe, the construction of new capacity being hindered by the legal procedure to which projects should be submitted for public discussion in most countries. There is a new runway operating at Amsterdam, though with environmental constraints. Also, new runways are planned at Frankfurt, and at Stansted and Heathrow, but the latter two in the UK will have long and arduous planning inquiries to negotiate. There are some possible technological and managerial possibilities for obtaining better use of the existing capacity, such as making use of the different characteristics of regional transport aircraft to implement a separate system of approach and take-off, as in the USA. However, the extra capacity would be exhausted within a very few years at current growth rates. Even if both proposed runways in the London area are built before 2020, there will already be another capacity shortage by 2025.

According to Boeing, air traffic will double by 2020 and new runways will be needed at 60 of the world's largest airports by 2025. In the [26] Boeing predicts that the world aircraft fleet will double by 2025 and estimates a need for approximately 27 200 new commercial airplanes (passenger and freighter). Over the next 20 years airlines will take delivery of approximately:

- 3 450 regional jets - 90 seats and below
- 16 540 single-aisle airplanes - 100-240 seats, dual class

8 *Airport Design and Operation*

- 6 230 twin-aisle airplanes - 200-400 seats, tri-class
- 990 airplanes 747-size or larger - more than 400 seats, tri-class.

Thus the biggest demand will be in the 100-240 seats aircraft segment. In the same time horizon Airbus predicts need for 21 860 new aircraft with stronger growth in the Very Large Aircraft (VLA - A380 and B 747) segment where about 1 263 new aircraft will be needed. However, the VLA will be flown on the densest routes only. About 44% of the aircraft will be centred on the ten largest airports and 66% of the routes will be flown by VLA from the top 20 airports in 2025 [26].



Figure 1-3 *Airbus 380 will be used on the densest routes*
(Courtesy: Airbus Industry)

Both companies anticipate the fastest market growth in the Asia-Pacific (including China) region but also in other evolving markets as Brazil, Russia and India. In these countries the traffic will grow three times faster than in North America and in Europe [26].

The changing structure of air transport, including not only the increasing number of small aircraft intended for direct inter-regional transport, but also the trend to liberalisation and the universally growing transport volumes, will even further increase the pressure on airport capacity. In addition, the airports must also satisfy the changing profile and new categories of passengers. They must prepare for increasing numbers of elderly people, of young parents with children and of the

disabled. New standards have made it necessary to reconstruct completely some airport terminals. All these pressures will require substantial increases in investment. Similar changes will appear in the carriage of freight.

The process of major airport development is taking progressively longer. The second Munich airport was only opened 30 years after the first plans were drawn up. The Fifth terminal at Heathrow will open in 2008, 12 years after the inquiry into it began and nearly 25 years after it was recognised as being necessary. It is therefore sensible to predict requirements perhaps 35 years ahead, yet the ability to predict even 15 years ahead is questionable.

The Far East has become the most rapidly expanding region from the viewpoint of further development of airports as the economy recovers its former vitality. The airports at Osaka (Kansai), Hong-Kong (Chek Lap Kok), Macau and Kuala Lumpur were opened in the 1990s. During the next 20 years it may be foreseen that at least six big international airports will be built there. The construction of each of them will take 10 years as a minimum, but with some of them, it will take up to 20 years.

After the opening of Munich II, Oslo Gardermoen and Athens Sparta and the major expansion of Madrid Barajas, Milan Malpensa, Manchester and Paris Charles de Gaulle (Roissy), the development of the network of new international airports in Western Europe may be considered as almost complete, except for the probability of a replacement airport for Lisbon. The remaining option for increasing capacity is the further development of existing airports. In general, this will be problematic because they have not reserved sufficient land for further development. Further airport capacity will be gained by reconstruction and improvement of former military bases and scarcely used 'secondary' airports flown mostly by low cost carriers like Frankfurt Hahn airport or Spain's Zaragoza airport.

The airports in the countries of the former Soviet block do have plenty of room for expansion. The relatively uncongested air space and poor condition of the ground transport infrastructure point to air transport as the only way to access these countries in the next 15 to 20 years. In comparison with other means of transport, investments in the infrastructure of air transport are small and can be made relatively quickly. The main problem is funding, because the whole Eastern block still suffers lack of capital resources. However, the new EU member countries could use EU structural funds and especially the Cohesion Fund for regional airports development.

It is anticipated that the 'hub and spoke' system will continue to be supported in the United States, so causing further pressure on capacity. The latest National Plan for Integrated Airport Systems has anticipated releasing \$US 41.2 billion from the Airport Improvement Program over the five years to 2009 to be spent among the eligible 3431 airports. Of this, 74% will go to commercial service airports, 41% to the 30 large hubs. 27% will be spent on bringing airports up to the latest

design standards and 21% on adding capacity. Three airports will get capacity-enhancing runways: Seattle, Washington Dulles and Chicago O'Hare, joining 12 airports that have had new runways since 1999. In addition, there will be one additional and one replacement airport. This will still leave New York, Los Angeles and Chicago short of capacity [114].

These existing and new airports will have to cope with the traffic in 30 and 40 years time. Yet it is not possible to foresee the changes that may occur in management and technology by then. There may be new types of supersonic aircraft. The growing Pacific Basin seems to be the most suitable area from that point of view. With a capacity greater than 200 passengers and flight range over 12 000 km, a supersonic transport would allow a considerable saving of time for passengers and contribute to a dynamic economic growth in the Pacific area, if the high altitude global warming problems can be solved. Its introduction would have a major impact on the airport infrastructure. So too would a 1 000 seat blended wing-body aircraft.

Development of Heathrow Airport

The development of Heathrow airport is used as an example to illustrate how requirements for the runway system and the other infrastructure of the airport can change rapidly and unexpectedly.

The history of Heathrow airport began in 1929. Richard Fairey Great West Aerodrome, which was used mostly for experimental flights was opened on the site of the present airport. In the course of World War II the Ministry of Aviation needed to build a bigger airport in the London area with longer runways that could be used by heavy bombers and airliners. In 1942 site selection started and in 1944 it was decided to build an airport at Heathrow with the then classical arrangement of three runways forming an equilateral triangle.

The war terminated before the airport was completed. It was necessary to adapt the airport project to the needs of civil aviation. It was not a simple task. It was necessary to estimate the development of civil aviation and its requirements after a six-year stagnation. A commission of experts assessed several options for completing the construction of the runway system using the three runways under construction. Apart from others, the commission determined these requirements:

1. The runway system should allow the operation of any type of aircraft, considering a crosswind limit of 4 kts ($2\text{m}\cdot\text{s}^{-1}$).
2. Two parallel runways should be constructed in each direction, with a minimum separation of 1 500 yards (1 371 m).

The resulting design was in the form of a Star of David. Originally the construction of a third runway triangle was planned to the north of the present airport, beyond the A4 trunk road. Thus a system of three parallel runways would have been available whatever the wind direction. That

additional triangle was rejected in 1952. By the end of 1945 the construction of the first runway and several buildings were complete, and Heathrow airport was officially opened on 31st May 1946.

The dynamic developments in air transport made possible by new types of aircraft required constant changes to the original project. By the end of 1947 the construction of the first runway 'triangle' was completed. Work on the second 'triangle' continued simultaneously with the construction of an access tunnel into the central area under runway No. 1. In 1950 the construction of the runway system was practically completed. In order that space may be found for a construction of terminals, apron and the remaining infrastructure in the central area, runway No. 3 and subsequently also other runways were closed very quickly, and thus only three runways have been in operation since then (see Figure 1-4). The cross runway is now to be closed to allow redevelopment of the East end of the central area, leaving only the now standard arrangement of one pair of parallel runways until and if a third short parallel runway is built on the site of the proposed third triangle.

The original terminal buildings were only of a temporary nature. They were located to the north of the northern runway, and it was clear that in the future they would have to be substituted by a new complex in the middle of the runway system. The construction of the new complex began in 1950 with the control tower and terminal building designed for short routes, this becoming the present Terminal 2. It was completed and opened in 1955.

In step with the increasing demand for air transport, new terminal buildings were built. In 1962 Terminal 3 was opened, designed specifically for long haul flights. In 1968 Terminal 1 designed for domestic airlines was opened. Terminal 4 was built in 1986 to the south of the southern runway after a protracted inquiry, and all British Airways' longhaul routes were moved into it from Terminal 3. This broke out of the central area for the first time, despite the difficulties caused by aircraft having to cross the southern runway and by passengers and bags having to be transferred between Terminal 4 and the central area.

Further increase in traffic beyond the present 69 million passengers per year is limited by the capacity of terminal buildings and stands. Therefore the British Airports Authority brought forward plans for Terminal 5 in place of the Perry Oaks sewage farm, between the two main runways at the west end of the site. After the public inquiry, which began in 1994, it was expected that the government's consent with the construction would be given in 1997. The first stage of the construction was supposed to last four years, giving a capacity of 10 millions of passengers per year (mppa) and a final capacity of 30 mppa.

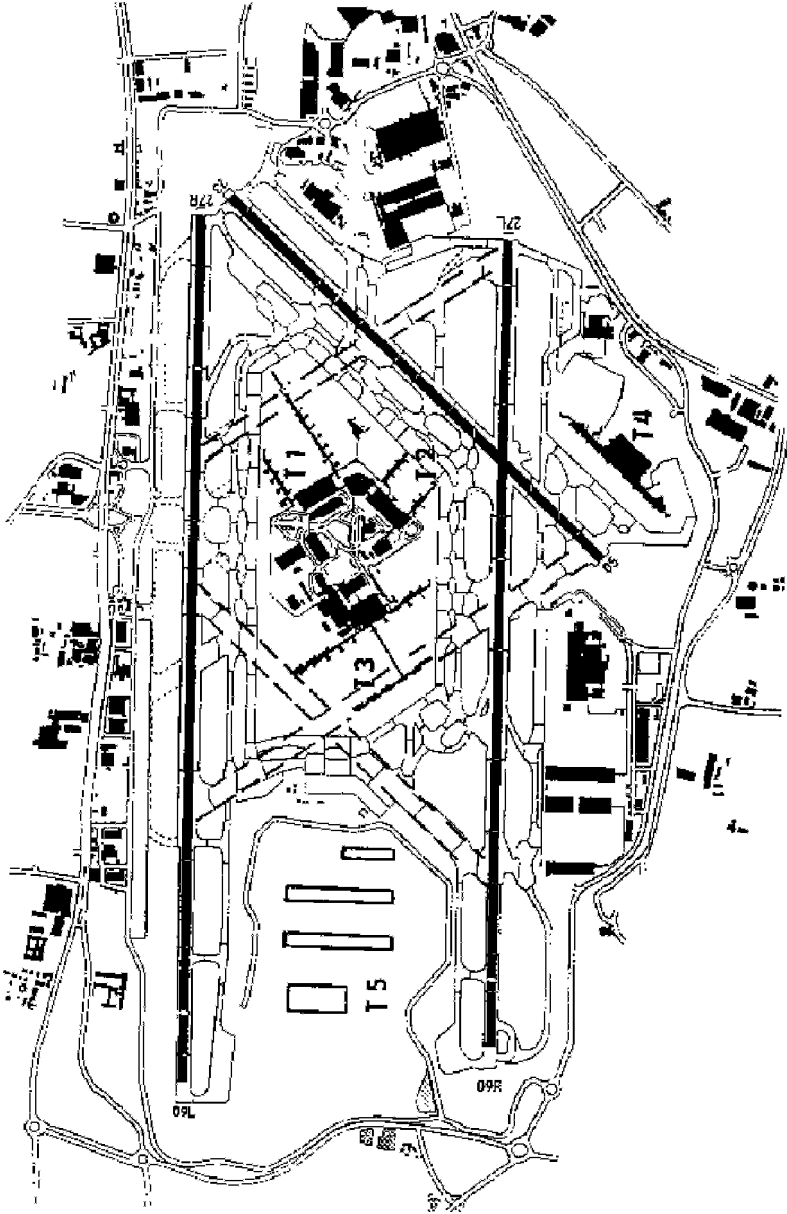

Figure 1-4 London Heathrow airport, original and present runway system and airport terminals, Terminal 5 to open in 2008.

In fact, the inquiry took four years and the terminal is due to open in the Spring of 2008 with one satellite. Completion will give a short breathing space for the central area to be redeveloped. The case for Terminal 5 depended on increases in aircraft size rather than on more flights, but further growth of Heathrow traffic after that will require the construction of the third runway. This has been recommended by the UK government, subject to EU environmental regulations being satisfied, but will still have to go through an exhaustive planning inquiry.

1.2 STANDARDS

1.2.1 ICAO Legislation

Safety is the overriding requirement in aviation. Standardisation is one of the means to achieve it. In the case of airports, it is standardisation of facilities, ground equipment and procedures. The only justification for differences is to match the types of aircraft that may be expected to use the airports. It is, of course, necessary for the standards to be appropriate and to be agreed by the aviation community.

Although attempts to reach agreement had been made much earlier, the need to agree common requirements for airports used by air carriers became more pressing after World War II. In compliance with Article 37 of the Convention on International Civil Aviation in Chicago in 1944, the International Civil Aviation Organisation (ICAO) adopted Annex 14-Aerodromes to the Convention on 29th May 1951. Annex 14 provides the required set of standards for aerodromes used by international air transport. The Annex contains information for planning, designing and operating airports. With the developments in aircraft technology described in the previous section, together with the consequent changes to airports, Annex 14 has been regularly amended and supplemented. Particular Amendments were in the majority of cases approved at sessions of the respective specialist ICAO conference on Aerodromes, Air Routes and Ground Aids (AGA). Each of the ICAO member states may propose a supplement or amendment to an Annex through its aviation authority. The proposal is usually assessed or further examined by a panel of experts. Each of the member states may nominate its experts to the panel. Within ICAO there are panels that have been dedicated to several specific issues for a long time, e.g.:

AWOP	All Weather Operations Panel—issues of operations under restricted meteorological conditions
VAP	Visual Aids Panel—visual aids of airports
OCP	Obstacle Clearance Panel

Other panels have been formed to consider a specific one-off problem, e.g.

ARCP Aerodrome Reference Code Panel—method for interrelating specifications of airports

HOP Helicopter Operations Panel—operation of helicopters.

The conclusions reached by the panels are reported in the form of working papers that are sent to the states for comments. Then amendments and supplements to the Annex are usually approved at the Air Navigation Conference or at the AGA conferences.

Each of the ICAO member states is obliged to issue a national set of Standards and Recommended Practices regulating the points in question for their international airports, and amplifying them as necessary. This can give rise to problems of language. The options for an ICAO member state are either to adopt one of the official ICAO languages (English, French, Spanish or Russian), or to translate it into its own language and notify ICAO accordingly. If there is a need, the member state may adapt some of the provisions in its national Standards and Recommended Practices if it files the differences with ICAO. The provisions in the Annex have two different levels of obligation and relevance:

Standards contain specifications for some physical characteristics, configuration, materials, performance, personnel or procedures. Their uniform acceptance is unconditional in order to ensure safety or regularity of international air navigation. In the event that a member state cannot accept the standard, it is compulsory to notify the ICAO Council of a difference between the national standard and the binding provision.

Recommendations include specifications referring to other physical characteristics, configuration, materials, performance, personnel or procedures. Their acceptance is considered as desirable in the interest of safety, regularity or economy of international air navigation. The member states should endeavour, in compliance with the Convention, to incorporate them into national regulations. The member states are not obliged to notify the differences between recommendations in the Annex and the national Standards and recommend practices. However it is considered helpful to do so, provided such a provision is important to the safety of air transport.

Furthermore the member states are invited to inform ICAO of any other changes that may occur. In addition, the states should publish the differences between their national regulation and the Annex by the means of the Flight Information Service.

Notes are only of an informative character and supplement or explain in more detail the Standards and Recommendations.

At present Annex 14 has two volumes; Volume I Aerodrome Design and Operations and Volume II Heliports. Besides the Annexes ICAO issues other publications. The following

manuals, which supplement Annex 14, include guidelines for aerodrome design, construction, planning and operations.

Aerodrome Design Manual (Doc 9157)

Part 1 - Runways

Part 2 - Taxiways, Aprons and Holding Bays

Part 3 - Pavements

Part 4 - Visual Aids

Part 5 - Electrical Systems

Airport Planning Manual (Doc 9184)

Part 1 - Master Planning

Part 2 - Land Use and Environmental Control

Part 3 - Guidelines for Consultant/Construction Services

Airport Services Manual (Doc 9137)

Part 1 - Rescue and Fire Fighting

Part 2 - Pavement Surface Conditions

Part 3 - Bird Control and Reduction

Part 4 - Fog Dispersal (withdrawn)

Part 5 - Removal of Disabled Aircraft

Part 6 - Control of Obstacles

Part 7 - Airport Emergency Planning

Part 8 - Airport Operational Services

Part 9 - Airport Maintenance Practices

Heliport Manual (Doc 9261)

Stolport Manual (Doc 9150)

Manual on the ICAO Bird Strike Information System (IBIS) (Doc 9332)

Manual of Surface Movement Guidance and Control Systems (SMGCS) (Doc 9476)

This book uses these ICAO documents, which are available from the world regional distribution centres, as primary references. It is not considered necessary to repeatedly refer to them in the

text.

1.2.2 National Standards and Recommended Practices

Some countries, like the United States, generate a full set of their own standards and recommendations which complement and expand on those contained in the ICAO documentation. These are published as Federal Aviation Administration (FAA) Advisory Circulars 139 and 150. Many other countries find these useful as reference material. In Europe the common standards will be developed and maintained across the European Union by the European Aviation Safety Agency (EASA).

All signatory countries to ICAO are obliged to apply the ICAO standards to their international airports. It would be uneconomic to apply them fully to their more numerous domestic airports, though it is sensible to take note of the principles embodied in the ICAO documents. Therefore every state has a possibility of making its own national Standards and Recommended Practices dealing with specific problems of domestic airports and airfields exclusively within the territory of the particular state for aerial works in agriculture, general aviation airports as well as for limited commercial operations. Besides the various types of civilian airports, there are also military airports. Their physical characteristics, marking and equipment may be different from the characteristics recommended for civil aerodromes. In creating a national set of Standards and Recommended Practices that does not derive directly from Annex 14 or another ICAO publication, the aviation authority usually puts an expert in charge of elaborating a draft of the document. The document draft is distributed for comments from selected organizations and panels of experts. After inclusion of the comments, the new draft is once more discussed in a wider forum. The proposal is also assessed in relation to other Standards and Recommended Practices. Elaboration of each legal document requires a considerable amount of time and effort. If the necessary amount of attention, together with adequate legal and technical resources are not put into the elaboration of the standard, the consequences can be serious. The document should be supplemented, amended, re-elaborated and exceptions from it should be noted, all of which takes further time and effort.

1.3 AIRPORT DEVELOPMENT PLANNING

The rapid development of air transport in the 1980s caused the capacities of many big European airports to be fully taken up in a very short time. The increasing volumes of passengers and freight will continue making demands for the expansion of airport facilities.

Although the majority of European airports have still an excess of capacity, as concluded at the meeting of the ECAC ministers of transport in 1992, each state is obliged to ensure development of

ground infrastructure, to detect and eliminate bottlenecks that are limiting the capacity of the airport system. In that way it should be possible to ensure that the increased requirements for capacity of airports in the future will be met. The solutions to these capacity issues can only be approached successfully on a system basis. It is necessary to assess the capacity of each part of the airport system individually: runway, taxiway system and configuration of apron, service roads, parking lots, cargo terminal and ground access to the airport. The result of such a system study is a proposal for staging the development of airport facilities, elaborated in a Master Plan of the airport.

An airport Master Plan represents a guide as to how the airport development should be provided to meet the foreseen demand while maximising and preserving the ultimate capacity of the site. In the majority of cases it is not possible to recommend one specific dogmatic solution. It is always necessary to search for alternative solutions. The result is a compromise which, however, must never be allowed to lower safety standards.

Planning of an airport's development is usually complicated by considerable differences between types of equipment and the level of the technology of the installations that are required for ramp, passenger and freight handling, and operations on the taxiways and runways.

The Master Plan of an airport may be characterised as: **'a plan for the airport construction that considers the possibilities of maximum development of the airport in the given locality. The Master Plan of an airport may be elaborated for an existing airport as well as for an entirely new one, regardless of the size of the airport'**. It is necessary to include not only the space of the airport itself and its facilities, but also other land and communities in its vicinity that are affected by the airport equipment and activities.

It must be highlighted that a Master Plan is only a guide for:

- 1/ development of facilities
- 2/ development and use of land in the airport vicinity
- 3/ determination of impacts of the airport development on the environment
- 4/ determination of requirements for ground access.

It is necessary to actually construct each of the planned facilities only when an increasing volume of traffic justifies it. Therefore the Master Plan of an airport should include the plan of the phasing of the stages of building. Table 1-2 shows what may be included in the Master Plan of an airport.

As it has been already emphasized, the Master Plan of an airport is only a guideline, and not a program of construction. Therefore it does not solve details of design. In a financial plan, which is included in Master Plan, it is only possible to make approximate analyses of alternatives for development, though costs of construction over the short term do need to be estimated with some

accuracy if decisions are to be made on the economic feasibility. The Master Plan determines the strategy of development but not a detailed plan of how to ensure financing of each of the construction stages.

The basic objective of the elaboration of a Master Plan should be that the interested parties must approve all approve it and the public should accept it.

Table 1–2 Purpose of an Airport Master Plan

I. General part

A. An airport master plan is a guide for:

- development of airport facilities, for aeronautical and non-aeronautical services
- development of land uses for adjacent areas
- environmental impact assessment
- establishing of access requirements for the airport

B. Beside others an airport master plan is used to:

- provide guidance for long and short term planning
- identify potential problems and opportunities
- be a tool for financial planning
- serve as basis for negotiation between the airport management and concessionaires
- for communication with local authorities and communities

II. Types of actions during the airport master planning

A. Policy/co-ordinative planning:

- setting project objectives and aims
- preparing project work programs, schedules and budgets
- preparing an evaluation and decision format
- establishing co-ordination and monitoring procedures
- establishing data management and information system

B. Economic planning

- preparing market outlooks and market forecasts
- determining cost benefit of alternative schemes
- preparing assessment of catchment area impact study of alternative schemes

C. Physical planning

- system of air traffic control and airspace organization
- airfield configuration including approach zones
- terminal complex
- utility communication network and circulation

- supporting and service facilities
- ground access system
- over-all land use patterns
- D. Environmental planning
 - preparing of an environmental impact airport assessment
 - project development of the impact area
 - determining neighbouring communities' attitudes and opinions
- E. Financial planning
 - determining of airport development financing
 - preparing financial feasibility study of alternative
 - preparing preliminary financial plans for the finally approved project alternative

III. Steps in the planning process

- A. Preparing a master planning work programme
- B. Inventory and documentation of existing conditions
- C. Future air traffic demand forecast
- D. Determining gross facility requirements and preliminary time-phased development of same
- E. Assessing existing and potential constraints
- F. Agree upon relative importance or priority of various elements:
 - airport type
 - constraints
 - political and other considerations
- G. Development of several conceptual or master plan alternatives for purpose of comparative analysis
- H. Review and screen alternative conceptual plans. Provide all interested parties with an opportunity to test each alternative
- I. Selection of the preferred alternative, development of this alternative and preparing it in final form

IV. Plan update recommendations

- A. Master plan and/or specific elements should be reviewed at least biennially and adjusted as appropriate to reflect conditions at the time of review
- B. Master plan should be thoroughly evaluated and modified every five years, or more

often if changes in economic, operational, environmental and financial conditions indicate an earlier need for such revision

Source: Airport Planning Manual, Part 1 Master Planning, (ICAO Doc 9184-AN/902)

2

PREDICTING TRAFFIC

Bob Caves

Motto: The only certainty about the future is that it will not be as forecast.

2.1 INTRODUCTION

The process of airport planning requires a large number of forecasts to be made. Most attention is given to the prediction of passenger and freight traffic. It is, however, also necessary to attempt to predict likely changes in aircraft and airport technology, productivity in passenger and freight handling, choice of access modes, number of airport workers and the number of ‘meeters and greeters’ per passenger, even the number of checked bags, together with airport cost and revenue per passenger. Also the airport planner is not alone within the air transport system in needing forecasts. The airlines, the manufacturers, the sub-system suppliers and the national transport planning authorities all need forecasts of air transport activity.

The technical feasibility and the strategic master planning of an airport can often be examined adequately in the imprecise light of maximum likely forecasts. However, the more detailed design of facilities and financial feasibility require a set of forecasts which estimate the demand to an acceptable level of accuracy at a given point in time.

The accuracy inevitably deteriorates as the time-horizon extends, yet even 25 years may not cover the expected mid-life of the project if the planning process requires 7-10 years. It should be noted that the forecasts themselves are dependent on the level of technology, average aircraft size,

income per capita, population, regional planning and a number of 'external' effects; in other words, the forecasts are usually implicitly 'locked-in' to the time frame for which they have been developed.

2.2 TYPES OF FORECAST NEEDED

The most fundamental forecasts are those for the gross annual throughput of passengers and freight for the system under consideration. This allows estimates to be made of the necessary scale of the system, its impact and, in gross terms, its financial viability.

For the more detailed planning and design purposes, the most crucial parameters are the flows of passengers, cargo and aircraft in the design hour, where the latter will normally be somewhat below peak hour flows, reflecting some acceptable level of delay or congestion in the system during the worst peaks. The passenger terminal layout and scale, and the revenue generation from concessions, are dependent not just on the total flow but also on the type of traffic, i.e. international/domestic, terminating/transit, charter/scheduled by class of cabin, and increasingly by the percentage of traffic performed by the low cost carriers. These flows are usually derived from similarly classified annual flows by applying calibrated ratios which allow for the change in the peakiness with airport annual throughput. Typical ratios are given in Ashford and Wright (1992) and in Caves and Gosling (1999). An alternative approach is to construct likely future peak aircraft schedules and to derive the flows directly from these with assumptions on aircraft size and load factor. A similar method with different parameters is usually adopted for cargo terminals, a most important parameter here being the proportion of belly hold to all-freight cargo.

The total design hour flow consists of locally originating and terminating passenger and cargo flows, together with the passengers transferring (either on one airline or interlining between carriers) and the transit traffic which usually stays on an aircraft during a short turnaround. Depending on the nature of the transfer traffic and the method of operating, it may be necessary to disaggregate it further for the design of customs and immigration facilities. Aggregation of all these traffic types allows an estimate of design hour air transport movements (atm) to be made, when combined with assumptions on the average design hour aircraft size and average design hour load factors. These aircraft movement data are essential for planning the airside capacity - runways, taxiways, aprons, gates. To complete the airside capacity planning, it is usually necessary to forecast military and General Aviation traffic, though the latter's influence on the design hour capacity requirement is being reduced at large hubs, as it is progressively priced out of the market.

2.3 METHODS OF ANALYSIS

Standard texts on demand analysis quote many possible methods for assisting in the prediction of traffic (e.g. Ashford and Wright, 1992; ICAO, 2006). The choice primarily revolves around the complexity and scope of the method and the timescale of the forecast. The more temporally stable and shorter term forecasts can usually be performed adequately with quite simple trend models which may not need to be unduly concerned with causality and uncertainty. This is not the case with long-term forecasts, which must concern themselves with unpredictable events both within and outside the air transport system. The choice is all too often determined by the availability of a data base and the budget for the study. Whichever method is chosen, the data used must be auditable, the results must be understandable and presented in such a way that the users can exert their own informed judgement.

2.3.1 Informed Judgement

The simplest method of all, that of informed judgement, appeals because it needs very little data - indeed, too much data confuses the decision maker and slows the process down. However, the difficulties of making long term judgements are illustrated by a 1960s study by the Rand Corporation (Stratford, 1969), which predicted that by 2015 there would be only a 10 times increase in investment in computers and that it would be possible to control weather at a regional level. The Foresight study by the UK Office of Science and Technology (Loveridge, Georghiou and Nedeva, 1995) surveyed technical experts in their own fields. Among many quite reasonable predictions, it also concluded that multimedia teleconferencing would be preferred to business travel by 2007, that the direct operating costs of aircraft would be halved by 2008 and there would be autonomous aircraft that would not need air traffic control by 2007, these dates being the averages of the responses. Experts in the travel trade have also made some interesting predictions of events which influence transport demand and supply (Moutinho and Witt, 1995), including a 58% probability of flying cars by 2020.

The Foresight exercise used a refined version of expert judgement called the Delphi technique, where a panel of experts has their judgements returned to them together with those of the other experts, so that they can adjust their views prior to the final collation of the results. The Delphi technique is also used by IATA in compiling airlines' views of the future.

Care should still be taken in using even the results of surveys of experts, since research shows that errors of individual judgements are systematic rather than random, manifesting bias rather than confusion. Further, many errors of judgement are shared by experts and laymen alike. Studies show that, at least in the field of fund management, the experts are no better than a random number

generator at choosing investments. Erroneous intuitions resemble visual illusions in an important respect: the error remains compelling even when one is fully aware of its nature (Kahneman and Tversky, 1979). Most predictions, even when using analytic methods, contain an irreducible intuitive component, for example in the assessment of confidence intervals. Research shows that these are often assessed too optimistically, particularly before repetition provides the opportunity for feedback on predictive performance, because judgements are often made on minimal samples and assumptions are too restrictive of possibilities. A classic example of this is the tendency for long term forecasts to be unduly influenced by short term trends.

The more data are available, the more informed the judgement can be, at the expense in time and cost of incorporating them. It is sometimes possible to take data off the shelf, but there is usually something incompatible about them. They may well fall short in terms of sample size or the extent of their disaggregation. Also, they are very likely to be out of date. Thus, when methods requiring much data are chosen, a prolonged and expensive data collection exercise will generally be necessary.

Sometimes it is possible, rather than using ready-made data, to use ready-made forecasts, such as those produced by the aircraft manufacturers and governments (Airbus, 2006; Boeing, 2006; FAA, 2006; ICAO, 2004), or analogy with a similar situation. Again, the problem is usually one of compatibility in time, space or characteristics of the setting. It may well not be appropriate to use available national forecasts to predict the traffic for a small regional airport. However, acceptable corrections can sometimes be made to suit the study in hand. Provided that adequate checks can be made on the validity of the base forecasts, this can often be the most cost-effective method.

2.3.2 Trend Extrapolation

It is usually necessary to generate some predictions which are unique to the situation under study. Further, the predictions have to be justified and therefore be based in some formal analysis of the historic development of the traffic. The simplest formal analytic technique is 'trend extrapolation', either in time or scale. Historic trends are derived by simple linear regression of the traffic itself or the annual growth rate. This is then projected into the future, modified by judgement to take account of changing circumstances. Short term trends often allow for the effect of economic cycles by applying some form of Box-Jenkins technique. Surprisingly, even the relatively simple data set required for trend analysis is not always available, or, if it is, it is not possible to discern a trend. Analogy or scenario writing then become invaluable techniques.

Longer term forecasts may recognise that the growth will mature over time by fitting the data to a Gompertz or 'S' curve (ICAO, 2006). The difficulty over the long term is that small adjustments when fitting an S curve to historic data can result in widely differing estimates of saturation levels.

Saturation can be estimated separately, to fix the size of the S curve, by, for example, assuming that the trips per capita, or ‘propensity to fly’ (ptf), eventually will not exceed those made in the US or Japan. This is a reasonable assumption since, regardless of how wealthy the travellers become, everybody has a limited time and energy budget. The relationship between air trips and wealth per capita is shown in Figure 2-1. It is, of course, necessary to compare like with like. The ptf on business for a small rural town is never likely to exceed perhaps 20% of that for a capital city, though, for the same category of household, there might be nearly the same ptf for leisure. The ptf for the retired population may be very different from that for single parents. It will be much smaller in small countries and those with excellent rail services.

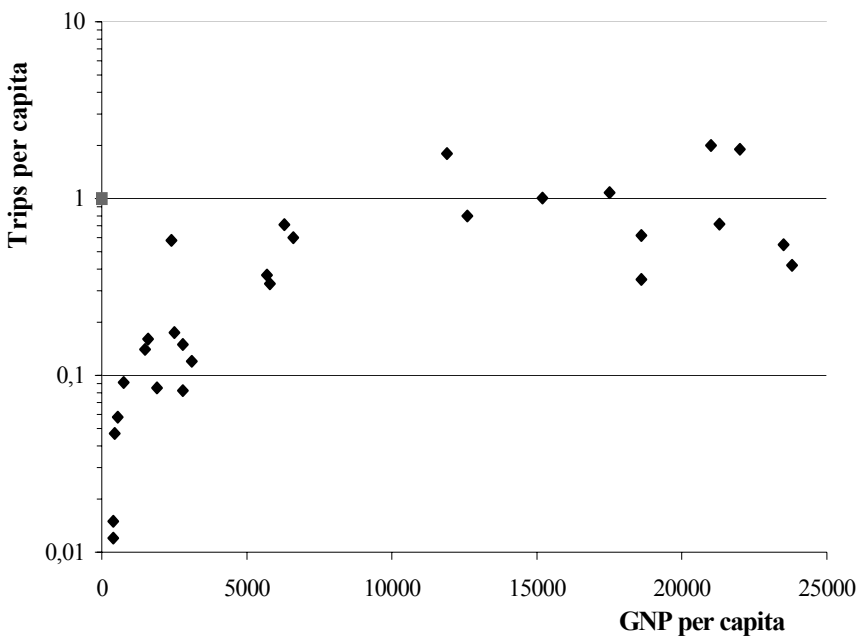

Figure 2-1 Propensity to fly

Another form of trend analysis is the ‘step-down’ procedure. This derives regional or local market shares from given national forecasts, making use of historic evidence of how the market shares have changed. The ‘step-down’ method is very popular in the USA, with its strong national forecasts and relatively stable traffic patterns, though it has been argued that the uncertainties created by deregulation in the distribution of traffic make it less appropriate now.

2.3.3 Econometric Models

If the above methods are deemed to be too naive, then it is necessary to bring causality into the analysis. The least complicated set of causal models is called econometric. These models try to relate the traffic to underlying economic parameters, or more readily available proxies for them. Usually they are calibrated by multiple regression of historic data to derive elasticities of demand, i.e. the change in demand due to a one per cent change in any one of the independent variables affecting the demand.

A typical econometric model might be:

$$\text{LnT} = -A + B\text{LnX} + C\text{LnY}$$

- where: T is a measure of traffic, like revenue passenger miles (RPK)
 X is a measure of income, like Gross Domestic Product (GDP)
 Y is a measure of price, like yield (revenue per passenger km)
 B is the elasticity of demand with respect to the specific measure of income
 C is the elasticity of demand with respect to the specific measure of price.

Models of this type carry a number of assumptions:

- that a satisfactory explanation is possible with only a few independent variables
- that the explanation is causal rather than co-incidental
- that the 'independent' variables are reasonably independent rather than suffering from multicollinearity
- that there is a constant functional relationship between the independent variables and the traffic
- that the independent variables are easier to forecast than the traffic itself
- that there are no significant errors in the data base.

Given that these assumptions can be accepted, the form of the model will depend on the particular circumstances. Multiplicative models are useful when the elasticities are essentially constant whereas exponential models are preferable when the elasticity varies with the independent variable. Difference models are to be preferred generally when the data set suffers from multicollinearity.

It is at least necessary to include terms to represent price and income, together with an autonomous trend term to allow for changes over time in things like quality of service. A greater number of independent variables may increase the explanation of the traffic, but the greater the number, the

more that have to be forecast. Also, it becomes increasingly difficult to interpret the model results.

ICAO uses very simple econometric models to predict global scheduled traffic:

$$\text{Log PKP} = 4.63 + 1.34 \log \text{GDP} - 0.58 \log \text{P yield} \quad R^2 = 0.975$$

$$\text{Log FTK} = -0.37 + 1.58 \log \text{EXP} - 0.37 \log \text{F yield} \quad R^2 = 0.997$$

where PKP passenger kilometers performed,

 GDP world gross domestic product,

 P yield revenue per passenger kilometer,

 FTK freight tonne kilometers

 EXP world exports

 F yield revenue per freight tonne kilometer (ICAO, 2004).

The very high R^2 show an extremely good fit to the historic data, due to the extreme aggregation of the traffic.

The use of elasticities is shown in Table 2-1. The income variable used for leisure travel is disposable income and it is predicted to grow at between 2.0% and 3.0% per annum. Its associated elasticity is calibrated to be between 1.5 and 2.5. The price (yield) is presumed to fall by 1.0% per annum and to have an associated elasticity of -1.0 . There is also an autonomous trend term calibrated at between 0 and 1.5% per annum. The consequent forecast is for leisure traffic to grow at between 4% and 10% per annum. Similarly, business traffic is expected to grow at between 3% and 4% per annum, the income indicator in this case being the value of trade and the traffic having a zero elasticity with respect to price. These elasticities are quite typical of developed air transport systems. Further examples of elasticities are given by ICAO (1986).

Econometric models may be applied to gross traffic, to route traffic or to generation of trips from a given geographic zone. Also they may be applied to classified sub-sets of the total potential travelling population in order to avoid the gross averaging process which is otherwise applied.

Any serious analysis of traffic at airports for marketing purposes, or to establish the viability of hubbing, really needs to work at the route-by-route level, and to understand the competitive situation in any origin/destination market. However, since the models are normally based in historic data, they deal only with demand which is revealed by the present behaviour patterns allowed by the historic characteristics of the transport offered. Also, there are many other aspects

of the travellers' behaviour which contribute to their travel decisions than simply the economic characteristics of the subject modes.

Table 2-1 The use of an econometric model

Determining Factors	Leisure	Business
Disposable income (% p.a.)	2 - 3	
Income Elasticity	1.5 - 2.5	
Trade (% p.a.)		4
Trade Elasticity		0.8 - 1
Real airline prices (% p.a.)	-1	-1
Price Elasticity	-1	0
Autonomous trend (% p.a.)	0 - 1.5	0
Potential growth (% p.a.)	4 - 10	3 - 4

Source: IATA Conference 1988, adapted by the authors

2.3.4 The Travel Decisions

To begin to model behaviour in more detail, it is necessary to consider the need to travel, the mode of travel and, if the mode is air, which airport the traveller will use. The generation element of the decisions may be dealt with by market category analysis techniques as used by Roskill (1971) or by econometric modelling. The trip generation per capita varies a great deal between industrial sectors and also by socio-economic group, with employees of small high technology research and development companies in the US making 150 trips per year while the average for UK citizens is one per year. In conventional transport planning, estimates of trip generation would be followed by distribution models, usually based on some analogy to the laws of gravity. This method presupposes that there is a reservoir of generated demand waiting to travel to any available destination. Simple models of this type ignore the important contribution of specific 'community-of-interest' between the origin and destination zones. A technique which distributes traffic as a function of relative attractiveness of the destination helps to overcome this drawback. Generation and distribution models can be applied to the air mode in isolation but, for shorter haul situations, it is more appropriate to model total generation and distribution and then to derive the modal split to air by use of a modal choice model.

2.3.5 Modal Shares

The availability of high speed rail services will certainly reduce air traffic on dense short haul routes, as demonstrated by the TGV experience. Airbus Industrie has suggested that a one hour advantage increases market share by 20 per cent (Reed, 1990). The Japanese experience, with quite similar fares for air and rail, is that air begins to take a greater share of traffic than rail at about 750 km, as shown in Table 2-2.

Table 2-2 Air and rail shares in Japan

A: Shares of total trips

Mode	300-500 km	500-750 km	750-1,000 km	1,000 km +
Air	4.5 %	13.9 %	50.0 %	83.6 %
Rail	48.8 %	64.8 %	37.3 %	13.2 %

B: Comparison of fares and journey times

Route	Rail - air fare (Yen)	Rail - air time (hr:min)
Tokyo - Osaka	3 930	1:30
Tokyo - Fukuoka	3 780	3:23
Tokyo - Yamagata	1 990	1:32
Osaka - Sendei	4 175	3:04
Nagoya - Sendei	4 860	2:15
Fukuoka - Niigata	5 975	5:09

Source: Air Transport World, July 1995, pp. 24-32, Adapted by the authors

Certainly there is a switch of even high yield traffic from air when door-to-door time by rail becomes less than three hours, but interlining and natural growth in traffic can still leave a significant air market: Orly to Nice, Orly to Marseille and Orly to Brussels remained as three of the densest routes in Europe (de Wit, 1995) despite the high speed rail opportunities, and BA's shuttle from Heathrow to Manchester has more than a million annual passengers despite trains averaging 160 km per hour over only 300 km. The resilience of air is due partly to the diffused nature of the demand within metropolitan areas (at least 50 per cent is home-based rather than office-based) and partly to the access to down-town rail stations being often more difficult than to airports. Less than 10 per cent of the European scheduled airline capacity is threatened by a future high speed rail network (Veldhuis et al, 1995). None-the-less, there are routes where rail does compete well, and

in these cases it can certainly serve to reduce the strain on air capacity. The political will to encourage a switch from air to rail for environmental reasons will also have an effect on the modal split.

Telecommunications may be able to replace some physical travel, but it is generally accepted that, over short haul distances, any substitution effects are compensated by stimulation of travel (Salomon, 1986). Videoconferencing on the desktop is likely to become very common. A major Swiss bank installed 75 units worldwide, their travel department applying a 'could it be done by videoconference' test (Arvai, 1993). The greatest impact in the US is expected to be in intra-company connections, where some 30 per cent of air trips may be substituted by 2010 (*Aviation Week, 29 November, 1993, p 40*). The future impact of telecommunications is more likely to affect long haul air travel. The differential advantages of teleconferencing must be greater at long distances, particularly with falling prices as the large capacity of fibre optic cables comes on stream. Telecommunication cost is almost constant with distance. The impact on aviation would be that a relatively small impact on the high yield business market might exert a pressure for increased fares in the highly elastic leisure market.

2.3.6 Discrete Choice Models

Attempts to increase the richness of the behavioural content of models are often made by using a disaggregate, or discrete, approach; involving the knowledge and modelling of individuals' trips. This type of modelling is usually more accurate in determining responses to changing supply or choices between alternatives, because it retains the maximum richness of the available information, rather than hiding some of the variety through the aggregation process. It is more important to use disaggregate information to calibrate a model: the application can often be satisfactory on aggregate data.

Most of the attempts to model the revealed choice behaviour of passengers have used individual trip data to calibrate logit models, because of the models' specific properties (Fischer, et al, 1990; Hensher and Johnson 1981). They express the probability of choosing an alternative in terms of the ratio of the utility to the passenger of any one of the alternative choices to the combined utility of all available alternatives, where the utility function to be maximised is a function of the attributes of the alternative and of the traveller. Almost always, the best explanation of behaviour in choosing between airports, between routes or between carriers has been obtained by using logit models with some combination of access time, trip cost and frequency as the dependent variables. The most important choice factor, after the availability of the service, is the ease of access to the service, as shown in Table 2-3. Other factors influencing the choice decisions are the nationality mix of the airlines, the aircraft technology and, of course, fares, though it is difficult to obtain data

on the fare actually paid. The effect of replacing turboprops with jets on competing routes from airports in the Midland region of the UK was estimated by comparing turboprop predictions with jet outcomes (Brooke et al, 1994).

Table 2-3 Choice of London airport, percentage by reason

Reason for choice of airport	Gatwick	Heathrow	City	All airports
Flights available	45.1	24.1	9.4	31.0
Nearest to home	13.4	11.4	20.0	13.3
Decision made by someone else	8.0	14.0	5.2	11.5
Connecting flights	3.3	11.7	0.1	8.3
Prefer airline	6.4	9.6	0.1	8.0
More economic / cheaper	10.4	3.5	1.3	6.0
Timing of flights	1.9	7.4	7.9	5.4
Nearest to business location	1.3	5.8	26.8	4.3
Total passengers (000s)	17 990	36 887	171	58 357

Source: UK Civil Aviation Authority, CAP 610, 1991, adapted by the authors

The improvement in market share due to jet service appeared to be less than 10%; indeed, it may have been less, because no attempt was made to disassociate the changes in type from the increase in aircraft size of the jets (85 seats, rather than 50-65 seats) and many in the airline industry believe that it is capacity rather than frequency which defines market share. However, other evidence suggests that a balanced market with both operators using turboprops would change to 80%/20% if one operator used jets at the same frequency (Aroesty et al, 1990), and this seems to be confirmed in the experience of introducing the new 50 seat regional jets.

2.3.7 Revealed and Stated Preferences

The data for disaggregate models is usually obtained from surveys of historic travellers; i.e. they are based on revealed demand. This clearly cannot account for those who have not travelled, nor for those whose travel decisions have been significantly constrained by the choices available to them: for example, charter passengers' departure airport is often constrained by flight availability. At the risk of irresponsible answers, these difficulties can be overcome by the use of 'stated preference' surveys. There are techniques for maximising the relevance of the answers obtained,

the best of which are probably to impose notional budget constraints and to check against actual behaviour. The prime advantages of the technique are the cheap and rich nature of the data and the ability to consider larger scale variation in the alternatives than have actually been tried in real situations.

Stated preference surveys are used as part of market research techniques to obtain a rich picture of support for planned initiatives or to explore the best ways of tailoring a product to the needs of the potential users. Often, focus groups are employed to represent the wider public for these surveys. Care must be taken with these methods that bias is not introduced by the way in which the questions are phrased.

2.3.8 Effects of Supply Decisions

The demand can only be converted into actual travel (revealed) if an appropriate service is offered. It is becoming increasingly common for supply decisions to be uncoupled from revealed demand. This is sometimes to correct an under supplied market, but it is often a result of airline or airport strategies. An example is the KLM initiative to markedly increase frequencies and capacity at Amsterdam to encourage hubbing. The traffic may then appear at points in the system that are quite different from those of interest to the passenger or shipper. It must be anticipated that many other, and more extreme initiatives will be taken as the possibilities of liberalisation of services in Europe are realised. Also, liberalisation is continuing to spread through the rest of the world.

The most telling of recent examples of supply decisions that do not rely on existing demand patterns are those of the low cost carriers in Europe. They often initiate routes from very small airports that have previously not had scheduled air service, the customers being prepared to travel long distances to take advantage of the low fares. Alternatively, they compete with established carriers and still stimulate equivalent levels of additional demand. The Bristol/Edinburgh route in the UK is a case in point. BA had 110,000 passengers in 2001. When EasyJet came on to the route, their traffic fell to 80,000 passengers while EasyJet carried 240,000 passengers in 2003 (CAA, 2005). Again, London/Edinburgh traffic had been almost static at 2 mppa (million passengers per year). EasyJet started services from Luton in 1995, Stansted in 1998 and Gatwick in 2001, and all had generated 0.5 mppa by 2003.

2.3.9 Uncertainty

The calibration of those models which attempt to introduce causality into the understanding of passenger behaviour require a great deal of data on the mode characteristics and the demography of the potential travellers, as well as richer socio-economic information than is generally used in

simpler econometric modelling. All the models' predictive ability also relies on being able to forecast the future trends of the variables used. Because of these difficulties, prediction based in any of the above methods suffers from likely errors which become greater as the time horizon increases. It has been said that a central case forecast is simply that outcome with a 50 per cent likelihood of being wrong in either direction.



Figure 2-2 *Market research requires various techniques of data collection*

(Photo: A. Kazda)

There seem to be four ways in which this problem of uncertainty can be approached. The most common approach is to use sensitivity analysis on all the factors which it is felt may be in error. A rather more sophisticated approach is to assign probabilities to the forecast of the independent variables and let the output take the form of a risk analysis. In this case no preferred forecast is offered, rather the forecast's uncertainties are made transparent to the decision maker. It should, however, be noted that there is much implicit judgement in the assignment of the probabilities, just as there is in all the quantitative methods. It is not only the purely judgemental methods that require judgement from the analyst. A third approach is the normative one of adopting policies to

limit or encourage demand - in this case the models' role is to provide the understanding necessary for setting the levels of policy variables to adjust demand to achieve the planning objectives. This method was used at Amsterdam to massage the mix of throughput to achieve the maximum of throughput consistent with meeting noise targets. The fourth approach is to recognise that it is not possible to predict the future, but that it can be explored by writing scenarios and interpreting the consequences.

2.3.10 Scenario writing

Scenario writing allows potential futures to be described. The forecasting techniques can then be applied to explore the traffic implications of each of those scenarios. Unfortunately, scenario writing is often used suboptimally, being limited to exploring options within the system under consideration with a view to predicting the future probabilistically. However, a more productive use is to explore the range of feasible potential futures and their consequences to identify the needs to which a system might be asked to respond and the steps it would need to take in order to respond effectively. It should be emphasised that the objective is not to guess the future, even by assessing probabilities of the various potential futures and hence take a view on the most likely future. Rather, scenarios explore potential futures so that some light can be thrown on the scope and flexibility which needs to be designed into the system, and on the consequences for the system's performance of not being able to meet the needs of some scenarios. Alternatively, the process can identify those possible futures which the system should not be designed to accommodate.

The essence of the method is to identify those factors which drive the business, but over which the business has little control, and condense them into several major themes. Once the consequences of the themes have been quantified using the conventional forecasting techniques, strategies may then be devised to meet each of the separate scenarios. Finally, the strategies are merged into a core strategy which is capable of responding to any one of the scenarios.

It can be taken for granted that the most likely future is the one which is presently being projected by in-house planners and system designers. It can also be taken for granted that, except in so far as the system's future use is predetermined by the closing off of future options by sunk investment, the most expected future will not coincide with any actual future state. None-the-less, this 'business as usual' case is an essential scenario, because it forms the base from which the relative implications of the other optional scenarios can be explored.

There are many options for writing scenarios. The important characteristics are that the scenarios should be cohesive and should show a feasible route from the present state to the potential future state. The latter requirement is made difficult because the dynamics of change are not well understood (Keynes quoted in Wills, 1972, p.165).

One example of the approach is to paint four potential scenarios (high and low growth, egalitarian or inegalitarian) for each of three (conservative, reformist, radical) ideologies, and to ponder the implications for international trade, political and economic stability and the need for transport. It can, for example, be inferred that a conservative high growth egalitarian society will generate technological sophistication in the northern hemisphere, and the encouragement of private transport, including aircraft. A reformist low growth more equal society would emphasise conservation and would encourage innovation in operating systems rather than in the technology of transport. The Dutch have used a consolidated version of these scenarios to inform their planning for Schiphol airport (Ashley et al, 1994).

Once inferences have been made within each of the scenarios of the likely associated impacts on the factors driving the econometric models, they can be used to quantify the implications of the various potential scenarios, in the same way that the models would normally be used for the prediction of expected traffic. It may be that one of the scenarios would lead to a halving of the cost per pkm, in which case the consequence would be a doubling of demand if the price elasticity consistent with that scenario was judged to be 2.0. Note that the traffic itself may or may not double, depending on other consistent inferences in the same scenario with respect to available capacity, income, etc.

2.4 HISTORIC TRENDS IN TRAFFIC

It is clear from the above discussion that much conventional forecasting activity relies on a knowledge of past trends: with some justification, because only an unfortunate coincidence would place the forecaster at the exact moment in time where a complete discontinuity occurred.

The gross uplift has grown approximately logarithmically over the long term. This has been fuelled by increasing wealth, reducing yields and improving supply characteristics. Recently, there has been a slowing of growth in the more mature markets but strong growth in the Asia/Pacific region, a rise in importance of freight and a fall in mail. The domestic market in the developed world has matured, except for the rise in the Low Cost Carriers (LCC). The growth in air transport movements historically was less than that in passenger or tonne kilometres because of a trend towards longer stage length, larger aircraft and, latterly, a higher average load factor. Over the last two decades, this has been countered by an emphasis on frequency in liberalised markets, and by the introduction of over-water twin-engine aircraft and regional jets of 50 seats and less.

Non-scheduled traffic, at least in Europe, has been much more sensitive to changing economic circumstances than scheduled traffic.

2.5 FACTORS AFFECTING THE TRENDS

2.5.1 Economic Factors

In the more complex and data-hungry models, gross or discretionary income per capita tends to be used as the main causal variable. However, at a local level, it is often difficult to get sufficiently local income data to be of much use for smaller airport studies. In more macro models, Gross National Product (GNP) is normally used as a surrogate for income. Modellers go to considerable lengths to interpret government views and to form their own views of future world events, but they tend to be dominated by conventional wisdom operating on common data bases. One must ask whether GNP is really any easier to forecast than traffic growth, particularly in the short term. Indeed, air traffic is often seen as an early indicator of what the economy will do. Also, one must ask whether the influence of GNP is all-pervading as indicated by simple correlation analyses at the macro level. The growth of traffic over time in Brazil suggests a more complicated relationship: the relationship between the change in the propensity to fly and the change in GNP per capita passed through levels of 5.5:1, zero and 3.5:1 as the economy has moved from the pre-industrial era through the formation of an industrial base and finally to development. ICAO (2004) predicted that world GDP would grow at 2.5% per annum to 2015. Boeing (2006) believes it will grow at 3.1% for the next 20 years. The FAA takes the forecasts of the Office of Management and Budgets, that world GDP will reduce from 3.6% growth to 3.0% by 2013.

Other important economic factors include exchange rate differentials which drive all types of travel, as exemplified by the changes in North Atlantic traffic as the dollar weakened in the late 1980s (Avmark Aviation Economist, March 1994, p 11). These are notoriously difficult to forecast but make a major difference in the competition between holiday destinations, as does the threat of terrorism. There are also likely to be shifts in the global distribution of economic activity and in the distribution of wealth both globally and within nations.

2.5.2 Demographic Factors

Conventionally, air traffic increases with population, urbanisation, reduction in size of households and with younger age groups. It is generally assumed that these variables are amongst the easiest to forecast and that their relationships with traffic growth are stable. However, forecasts of the USA population in 2010 have varied since 1945 from 291×10^6 to 381×10^6 as the births per 1000 women have changed from 85.9 (1945) through 122.9 (1957) to 73.4 (1972). Again, the tendency for an increased propensity to fly (PTF) may currently be explained largely by income, household make-up and job-type factors. It is quite possible that these relationships may break down. The changing structure of industry and commerce could affect air trip generation rates. Propensity to

fly (ptf) varies greatly with the type and size of firms. There is evidence of a reversal of domination by the top 500 Fortune companies in the US (Makridakis, 1995), which could have a strong bearing on the future ptf's.

There is already a tendency to decentralisation of metropolitan areas (New Scientist, 15 June 1996, p 11), and this may lead to greater demand for lower density air travel.

Some feel that the information revolution, or 'fourth logistic revolution' (Anderson and Batten, 1989), will result in fast and volatile flows of commodities, people and information, leading to a preference for the fastest and most direct mode of travel. This type of future, where a new hierarchy of cities evolves with the most powerful being those based in the four Cs of Culture, Competence, Communication and Creativity, is already visible. It should be considered together with other demographic trends, including the labour migration flows which eventually form the basis for Visiting Friends and Relatives traffic (International Labour Rights, Second Quarter, 1993), and changes in fertility and mortality.

2.5.3 Supply Factors

Cost per passenger kilometre (pkm)

At constant levels of regularity, reliability, frequency and comfort, the primary supply factors determining demand are ticket price and generalised cost (i.e. a combination of price and value of time saved). The price is determined by the underlying cost of production and the pricing policies adopted to generate revenue. The costs of production are, in turn, determined by operating policies with respect to load factor, aircraft size, input factor costs, productivity and advances in technology. The load factor in turn depends on price, the revenue yield per seat generally falling as load factor rises. Estimates of world-wide load factors on scheduled flights reveal an increase at about 1/2 per cent per year from 55 per cent in 1975 to 70 per cent by 2002. US carriers achieved load factors of 77.1% in 2005.

Aircraft size

Aircraft size had been expected to increase on the densest routes, most of the forecast demand being taken up by size rather than frequency in order to reduce costs in the competition for the low fare passenger and to combat the effects of congestion. In this case, annual growth in seats would have been almost the same as passenger growth. In the event, even on these dense routes, frequency competition appears to be overcoming any shortage of runway capacity, resulting in more flights with the same size of aircraft. On lower density routes, and where increasing

competition is unhindered by congestion, increased frequency may well cause even higher atm growth rates, led by the LCCs. Meanwhile, ever more powerful revenue management systems have allowed airlines to sell increasingly marginal seats, so increasing load factors with little increase in revenue per flight. Some airlines, notably BA, have been reducing capacity in order to reverse this trend of excessive yield dilution. It is now expected that average aircraft size will more or less stabilize at current levels. Boeing (2006) expect that single aisle aircraft will still make up 60% of the world passenger jet market by 2025, the fleet being 5040, 21470, 8070 and 1390 for regional, single aisle, twin aisle and very large aircraft respectively, including freighters. Equivalent estimates from Airbus (2006) for passenger aircraft are 20,332 single aisle, 5712 twin aisle and 1263 very large aircraft, with another 1226 very large aircraft needed for freight. Airbus believe that greater urbanization, the importance of reducing costs and the continual strengthening of hub-to-hub routes will require a greater emphasis on size rather than frequency, the average aircraft size increasing by 20% over the 20 years.

Cost of input factors

Fuel has dominated the historic changes in input factor prices. A combination of shortages and the long lead times for aircraft technology to respond to the situation has, from time to time, caused considerable problems for the industry. The FAA (2006) thinks that fuel costs will fall slightly until 2011, then rise by 2% pr annum to 2017. Operational changes have helped to alleviate the situation, but in the longer term the larger cost reductions to combat forecasts of fuel price increases will have to come from the technology. The combined effect of improvements in labour costs, advances in technology and reductions in the first cost per seat of aircraft are unlikely to result in a total cost reduction of more than 1 per cent per annum.

Technology

The impact of technology on future capacity is often the most neglected area of supply prediction. Heathrow's growth is a case in point, early predictions being hampered by inhibitions on the maximum feasible size of aircraft and more recent analyses by under prediction of annual runway capacity. Most studies only allow for changes in a single factor (e.g. regional jets) which is closest to the study at hand. In fact, it is clear that there will be changes in navigation, communication, guidance on approach and on the ground which will have implications for capacity, as well as changes in vehicle technology which will affect both cost and capacity. It is less clear if and when specific changes will be introduced, though they will only occur when there is a sufficient economic incentive. However, it is likely that fuel efficiency will continue to improve as in the past, at the rate of 37% over 20 years (Airbus, 2006).

Management

The technical changes will often open up new opportunities for changes in management style, as with new routes and networks for airlines, new operating procedures around airports, advanced revenue management systems and improved facilitation through the use of smart cards. However, managers can also innovate without technology, as is seen by the growth of the low cost carriers and the forming of global alliances. These and other initiatives will continue, but which of them, when and in which combinations can only be explored by scenario writing.

Capacity constraints

The above factors will only influence future traffic in the expected way if sufficient investment is made to accommodate the potential demand. Therefore, any political decisions could interfere with forecasts, as could any ineptitude in the planning process. In an ideal forecasting process, these effects would be internalised within the method, but political forecasting is not yet sufficiently advanced to allow this. The UK government has encouraged the development of two more runways in the South East of England by 2030, but recognizes that this would only accommodate 465 mppa out of the estimated 490 mppa unconstrained forecast. A third runway at Heathrow, allowing 128 mppa at the airport, would only meet 70% of its unconstrained demand by 2030.

Fares

All the above supply factors affect the level of fares charged. Management also can adopt policies to cross-subsidise routes or classes of traveller, so that there is often in the short term only a limited relationship between the actual price paid for a ticket and the underlying costs. Data on real air fares paid are usually only available to analysts on an aggregate basis for all operations of an airline, quoted as yield per pkm.

Forecasts of changes in fares by the pertinent carriers have to be made largely by judgement. Given the huge changes in demand levels created by the LCCs, these judgements are very important in producing reasonable estimates of traffic at an airport. Once made, they may then be used to estimate traffic by using fare elasticities. The derived historic elasticities may be modified as necessary to allow for changes in local conditions. It should be noted that none of these supply costs, fares or elasticities are necessarily appropriate for situations other than those for which they were derived - for example, Jung and Fujii indicate that short haul price elasticity in the USA may

be as high as 2.74.

ICAO (2004) suggests that scheduled passenger yields will fall by only 0.5% per annum to 2008, and then stabilize. The FAA in the US, on the other hand, thinks that domestic yields will fall by 0.8% per annum to 2017 (FAA, 2006).

2.5.4 Economic Regulation

Since the deregulation of US domestic air transport in 1978, the liberalizing ethos has spread through Europe and many other countries. It has been accompanied by a parallel trend to the privatisation of airlines and, later, of airports. Without these trends, there is less opportunity for competition, for fare reductions, for route development, for alliances, for efficiency gains and for airports to take marketing initiatives. There have been abuses of the monopoly positions that have been made possible by the new freedoms. Rather belatedly, this has led to the imposition of regulatory controls on monopoly powers. The regulatory setting should be incorporated in scenario descriptions, including free trade, open skies, foreign ownership and environmental taxes or capping as well as the regulations to control monopolies.

2.5.5 Environmental Regulation

Another aspect of regulation is the national and international stance on recovering the environmental costs induced by air travel. Specifically, it is expected that some form of carbon tax will be imposed on aviation. This will be introduced in Europe in 2010 together with a carbon tax trading scheme, so that aviation can buy credits from those industries which do not use their full quotas. The UK Department for Transport (DfT) has predicted that the charge will start at £70 per tonne of carbon and will then rise annually by £1 per tonne. Doubling the charge would reduce demand in 2030 by only 2 percent (DfT, 2006), as increasing fuel price from the central estimate of \$45 to \$72 per barrel. These are small effects relative to a 10 per cent increase in the GDP, which would increase demand by 5 per cent.

2.5.6 Cargo

The analysis of the cargo market is similar in basic method and in the variables which generate traffic. Some additional factors affecting cargo growth are:

- continuing increased share of integrated carriers
- time and cost sensitive products

- early stage of a product's cycle
- availability of surplus capacity on routes
- regulation of facilitation
- competitive advantage over other modes.

More detail on the factors driving air cargo may be found in Chapter 11.

2.6 CONCLUSIONS

The discussion has identified the requirement for forecasts of arriving and departing passengers disaggregated by purpose and type of destination, and of air transport movements by type of equipment. These forecasts are required on an annual basis but, more importantly, for the representative peak hours. Information is also needed on General Aviation and military activity, but the impact of this traffic on design hour movements is more a function of airport policy than of the unconstrained volume of traffic.

The methods available to make these forecasts have been reviewed and shown to be more or less adequate for short term detailed planning and design, but to offer little more than a formal basis for reasoned judgement in the long time horizons needed for airport system and master planning. Interactions between the variables which control demand are not sufficiently understood to allow more certain forecasts to be developed, so that informed judgement must be used. This judgement may be expressed explicitly as high and low forecasts, or it may be combined with formal attempts at risk analysis, or it may inform the interpretation of future scenarios.

It is clear that there should be consistency between forecasts for airports throughout the system. The obvious way to obtain this consistency would be by modelling the complete air transport net with a single methodology, a single set of assumptions and a consistent set of data. However, not only is it rare to find the resources for this, but there is a real danger of constraining the output to that which follows from a dominant preference of one member of the team of analysts and advisors. There is no substitute for keeping an open mind on the future, and exploring a wide range of possibilities. Consistency of methodology is undoubtedly necessary for communication and interpretation, but the inputs to the prediction process should be allowed to vary as necessary to reflect the variety in the system.

No particular model will always be the most appropriate, nor will any one model always give the most accurate prediction. It is always worth using more than one approach. Much can be learnt from a comparison of the outcomes relative to the constraints of the modelling. However, the

balance of cost and competence will often be best achieved by a simple econometric model, applied to a carefully selected set of markets that most affect the total traffic. If necessary, these models can be used even without a good historic data set for calibration, since, with care, appropriate elasticities can be borrowed from other studies.

Many of the important imponderables are external to the air transport system, and are best dealt with by incorporation in a range of comprehensive scenarios. Inside the system, many other factors over which most airports have little control have been identified in Section 4, and these also should be included in the scenario descriptions.

Apart from economic growth, the factor which strongly influences the rate of growth of demand in the short term is the airlines' and the regulators' policies on fares. The conventional wisdom sees a continuation of a low fares policy fuelled by deregulation, leading to high load factors and larger aircraft. If this approach leads to insufficient yield to at least maintain the present airline rates of return on investment and hence leads to lack of capital to fund the needed extra capacity, the airlines may retrench and rely on the essential business traveller. If this happened, too much surplus capacity would have been provided. The low cost carriers can make good use of some of this capacity, but experience suggests that only the most resilient LCCs survive.

The development of technology, both to combat fuel availability and rising price and also to counter the physical and environmental constraints on airport development, is important in the longer term. Further interruptions in the oil supply may increase the rate at which more fuel-efficient aircraft are developed. Advances in aircraft technology and approach guidance, designed to allow changes in operational practices, will be important in lifting the capacity constraints at large airports. Their implementation depends partly on whether the large global carriers really want capacity to be increased at their hubs.

One other air transport factor which is particularly important in determining an individual airport's traffic is the extent that the network develops as a hub-and-spoke system rather than concentrating on direct connections. If networks predominate, it is important to forecast which airports are chosen as hubs or as spokes or are left out completely. To some extent, the airports will influence this, since a hub system will not develop easily if transfers are not convenient.

Despite all these caveats, forecasts are still needed, so one current view of the future is now given in Table 2-4. A low fare policy may result, in the short term, in emplanement growth rates higher than those forecast as mean values. Other expected trends are for ATMs to grow more slowly at larger airports and for cargo to grow faster than passengers. The forecasts will depend on conditions at individual airports in terms of level of maturity, surface competition, marketing and

the airport's share of the national traffic.

Table 2-4 Annual average predicted growth in passenger kilometres, 2005-2025

Traffic Growth to/from:	Asia/Pacific	North America	Europe	Latin America	Middle East	Africa
Asia-Pacific	6.4	5.9	5.5	8.8	6.0	6.3
North America		3.6	4.5	4.9	6.0	7.4
Europe			3.4	5.1	4.9	5.0
Latin America				6.9		8.7
Middle East					5.0	6.1
Africa						6.1

Source: Boeing (2006), adapted by the authors

Airbus predicts annual growth to 2025 as 4.8% for revenue passenger kilometers (rpk), 4.3% for seats and 3.6% for departures. Highest rpk growth to 2025 is expected in India at 12.3% and in China at 8.2%, per annum. Airbus expects the Asian carriers to have 32% of world rpk by 2025, compared with 27% in Europe and 25% in North America. The US FAA (2006) expects the growth rates for all US carriers from 2005 to 2017 to be: revenue passenger miles (rpm) 4.3%, passengers 3.4%; the regional traffic will grow faster at 6.4% and 4.3% respectively. ICAO (2004) predicts that world scheduled rpk will grow by 4.4% to 2015, internationally by 5.1% and domestically by 3.1%. It also predicts air transport movements (atm) to increase by 3.2% per annum. IATA's highest short term growth predictions to 2009 are 6.8% within Asia-Pacific, 6.7% Asia-Pacific/Middle East, 5.3% North America/Europe, 5.9% Asia-Pacific/Europe, 5.8% Asia-Pacific/North America, with domestic China achieving 9.6% per annum.

In lieu of any specific study for a particular airport, the gross regional forecasts may be used to factor up from base data, with the caveats mentioned in this section. The peak hour atms may be estimated by making assumptions about the peak hour fleet mix and load factor. These last two factors will always depend very much on the circumstances at any particular airport, not least the amount of transit traffic on the aircraft.

This page intentionally left blank

3

AIRPORT SITE SELECTION AND RUNWAY SYSTEM ORIENTATION

Tony Kazda and Bob Caves

3.1 SELECTION OF A SITE FOR THE AIRPORT

The construction of a new aerodrome or an enlargement of an existing one represents extensive investments and building works. It is therefore necessary to design the entire aerodrome project for the longest time period possible. The maximum possibilities of the airport development in the proposed locality should be considered, within the limits of the airport's critical constraints. As well as ensuring that the capacity and operational requirements are met safely, the issues concerning the airport and its surroundings should be considered, particularly the impact of the airport on the nearby population and environment. The locality selected for the airport and orientation of the runway system should facilitate a long-term development of the airport at the lowest cost in terms of money and social impacts.

Selection of a suitable site for the airport should begin with an assessment of any existing airport and its site. It is nearly always easier to modify an existing airport than to create a new one on land that has previously had a different land use designation. The assessment is made in the light of the

prospective passenger market, its growth rate and any limitation of the growth resulting from, for example, a demographic shift of population. Therefore the prognosis of the growth of a number of passengers and volume of air cargo in the catchment area of the airport is one of the key elements in planning the airport development. The methodology of forecasting traffic is considered in Chapter 2 – Predicting demand.

After the proposed airport's size and layout has been approximately determined by a preliminary study, possible sites for the development of the airport are assessed in several steps, the principal ones being:

- approximate determination of the required land area
- assessment of the factors affecting the airport location
- preliminary selection of possible localities from maps
- survey of individual sites
- assessment of impacts on the environment
- revaluation of the selection of possible sites
- production of site layout drawings
- estimate of costs, revenues and discounted cash flow
- final selection and assessment of the preferred site
- elaboration of the final report and recommendations.

The same procedure is followed in principle when assessing the development of an existing airport, though some of the steps may be omitted. The number, location and orientation of the runways and of the taxiway system should meet the following criteria:

- the availability (the usability factor) of the runway system should be acceptable, considering the losses which would result from the unavailability of the airport
- obstacle restrictions defined by the obstacle clearance limits should be respected
- ideally, the final capacity of the runway system should meet the predicted demand in the typical peak hour traffic in the far future
- the site selected for the airport should be considered not only from the viewpoint of obstacle clearance limits and environmental requirements but also from the viewpoint of achieving a functional layout of the aerodrome facilities
- the ground transport access to the airport and the urban development plans in the airport vicinity should be efficient and sustainable

→ the site should be in accordance with local and regional land use plans.

3.2 USABILITY FACTOR

The ease with which acceptable usability of the airport can be provided depends on meteorological conditions in the selected locality and the topography of the site. The usability factor is defined in Annex 14, Volume I., Chapter 3 as: ‘The percentage of time during which the use of a runway or system of runways is not restricted because of the cross-wind component.’ It can therefore be provided most economically by optimising the runway directions relative to the prevailing wind directions. The actual runway orientation is the result of a compromise between the usability and other factors. The sensitivity of an aeroplane to cross - wind depends mainly on the aeroplane mass and the type of undercarriage. The greater the aeroplane mass, the faster it tends to fly and the less sensitive it is to the wind. Airports for large aircraft should therefore be able to meet the usability requirements without resorting to more than one direction, but the design will also be influenced by the length of runway to be provided, the associated difficulty of levelling the site, the location of areas of population, the existence of sites that encourage birds and the obstacle clearance requirements. In any case, it is usually necessary for a large airport also to cater for the needs of smaller aircraft, so it will often be necessary to install short cross runways to provide adequate usability for them.

**Table 3-1 Wind distribution statistics by direction and speed in per mille
Meteorological station – Bratislava M.R. Štefánik airport**

Wind speed/ direction	N	NE	E	SE	S	SW	W	NW	calm	Σ
calm	-	-	-	-	-	-	-	-	123	123
1 - 2	40	82	52	31	25	23	23	65		341
3 – 5	45	45	34	37	26	16	19	111		333
6 – 10	39	3	5	15	16	4	9	90		181
11 – 15	4	0	-	0	1	0	1	15		21
16 – 20	-	-	-	-	-	-	-	1		1
> 20	-	-	-	-	-	-	-	-		-
Σ	128	130	91	83	68	43	52	282	123	1000

The number of runways in the airport and their orientations should provide at least a 95 % usability factor for the types of aircraft which are intended to use the aerodrome, presuming very conservative crosswind capability of the aircraft. A basis for calculation of the usability factor are the data on percentage occurrence of the wind of the given direction and speed for a period of at

least five years. The statistical data are usually published in the form of a table (see Table 3 - 1), or in the form of a wind rose.

Determination of the usability factor may be made by several methods. It is best to choose a method which is likely to underestimate the usability rather than the opposite.

For a rapid assessment, the transparency method is used (Figure 3-1). The statistical data on percentage occurrence of the wind of each combination of direction and speed are plotted in the form of a compass rose. The value of percentage occurrence is recorded in a window which corresponds to the direction and speed of the wind. The width of the overlaid transparency is equal

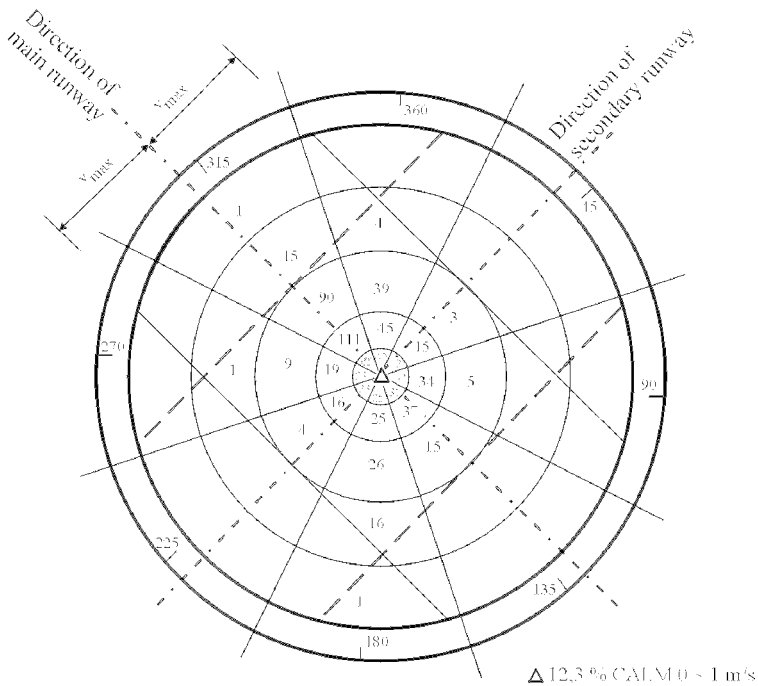

Figure 3-1 *Determination of the usability factor - transparency method, Bratislava M.R. Stefánik Airport*

to twice the maximum allowable cross-wind speed. The transparency is turned in such a way that it covers the maximum of the percentage wind occurrences. The same method may be repeated for each additional runway until the combined coverage meets the required usability factor of the runway system. The whole process is then repeated for other maximum crosswind criteria.

For a more exact evaluation of the usability factor, it is convenient to use the Durst method. The

basis of this method is a rectangular co-ordinate system (Figure 3-2). Directions of a compass rose are developed in the x axis and speeds of the wind in the y axis. In the created fields the percentage wind occurrence and speed are recorded. The following function is plotted into the grid:

$$f = v \cdot \frac{1}{\sin \alpha}$$

where:

v is the maximum value of the cross-wind

α is the angle which is formed by the runway axis with particular directions of the compass rose.

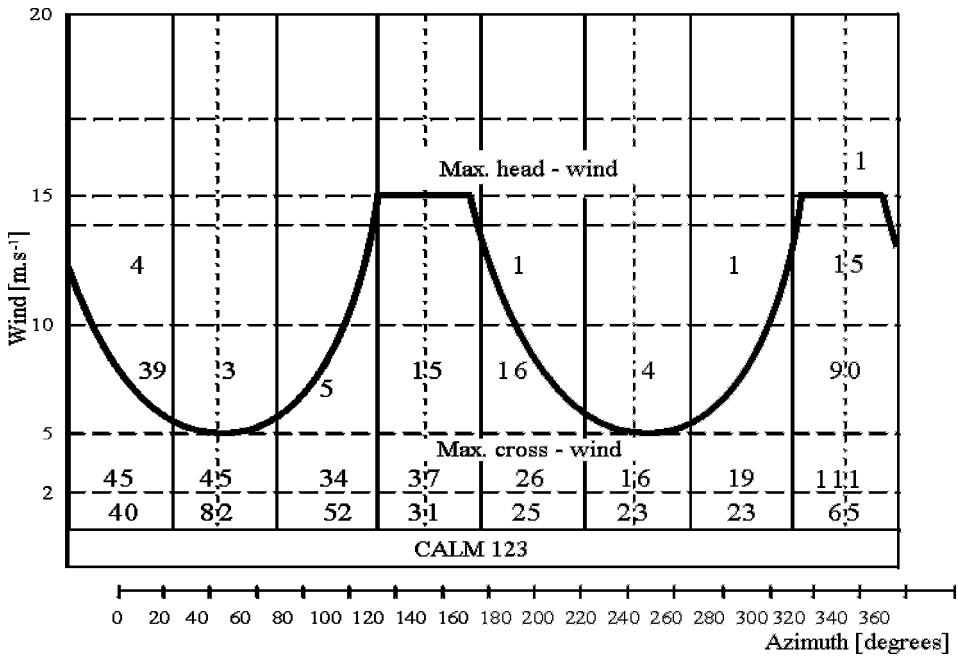

**Figure 3-2 Determination of the usability factor – Durst method,
Bratislava M.R. Stefánik Airport**

In the direction of the runway axis, the function increases to infinity and the usability factor is limited by the maximum value of the head wind. The lowest point of the function is actually the value of the maximum cross-wind (α = 90°). When the numerical values under the function are summed, the usability factor of the runway, or of the runway system, is given.

3.3 LOW VISIBILITY OPERATIONS

Large airports are expected to continue to operate in poor weather but it is important to consider the occurrence of low visibility and low cloud base ceilings on the way the airport operates. The occurrence of Category II or III visibility (Table 3-2) represents a significant qualitative change as a consequence of considerably lowered abilities of the pilots, air traffic controllers and other persons involved to maintain the procedures and an expeditious flow of air traffic with a visual reference. A change from I to II and any lower category entails more than just the provision of the visual and non-visual navigation aids. Performing operations under low visibility conditions depends also on the system of air traffic control, meteorological equipment and services, surface movement guidance and control systems, runway protection measures, emergency procedures and apron management. It requires also a change of the system of airport control and of the attitude of all the airport staff to fulfilling their duties. It is necessary to introduce a system of airport operation quality control when operating in these lower visibility conditions.

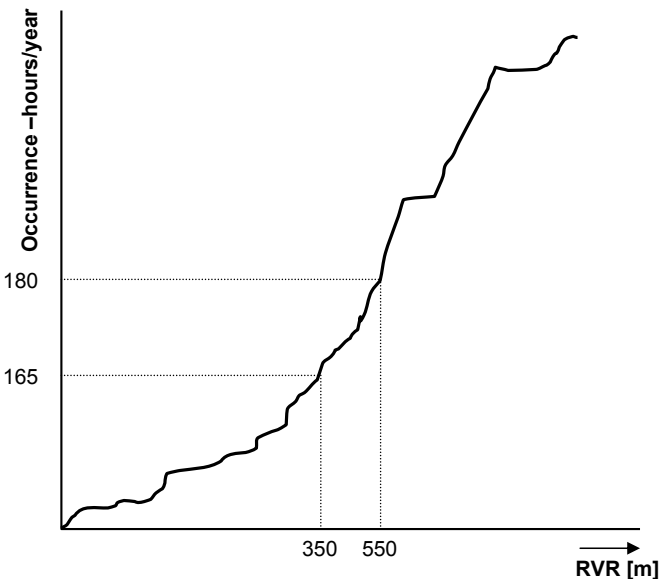

Figure 3-3 Occurrence of low visibility conditions [hours/year]

It must be emphasised that lowering the weather minimum is more an economic than a technical problem today. Category II or III equipment and operations represent significant costs for airports and airlines. However, in most cases it is the only way to guarantee the reliability of operations during the whole year without significant disruptions. Diversions are expensive both for airports

and airlines. For airports it is the loss of landing, parking, handling and passenger fees and a bad image of the airport. For airlines there are direct costs resulting from passenger compensations, other costs as a consequence of disruptions to the fleet planning and also a bad image for the airline. Sometimes, even if it appears sensible for an airport, some aircraft operators may not wish to upgrade their avionics or their pilot qualifications. On the other hand, many operators may only agree to operate at the airport if Category II or III is available to guarantee the regularity of flight operations.

In some cases the selection of a site has been made without considering poor visibility conditions, thinking that the ground equipment would ensure the required regularity and allow for the aeroplanes to land under any conditions. However, the lower the operational minima, the bigger the capital and operational costs incurred. The ground equipment designed for operation under the conditions of the ICAO Category II or III are not only more expensive but also substantially more complicated and demanding for maintenance. The runway can be out of service during maintenance, so the total availability of the runway can be further reduced if there is 24 hour operation. Also, during poor visibility operations, the runway system capacity decreases considerably. However, the lower the minima, the less frequently those weather conditions occur (Figure 3-3).

When an assessment of the runway equipment is made, it is necessary to determine the extent to which it is cost effective to lower the minimum. The decision is usually based on the prevailing meteorological conditions during the peak hours and the expected number of diverted flights gained or lost. At many busy Mediterranean airports it is quite usual that they have only instrument runways as most of their traffic is concentrated to the summer season with good meteorological conditions. Therefore, when selecting a site for an airport with international or scheduled traffic, it is necessary to pay attention to an assessment of weather conditions, including occurrence of reduced visibility and low cloud base, and the associated costs and benefits.

For determination of the usability factor including the effect of low visibility, the Antonin Kazda method may be employed. (1). The method evaluates the usability factor in two steps:

1. Evaluation of the usability factor including the effect of crosswind if the visibility or the runway visual range is greater or equal to 550 m.
2. Evaluation of the usability factor considering the RVR limits without taking the wind into account if the visibility or the runway visual range drops under 550 m.

1 KAZDA A.: Evaluation of the Usability Factor of Aerodromes. PhD thesis, University of Transport and Communications Žilina 1988

Note: If historic data of RVR measurement are not available then visibility data might be used. In this case a critical value of 400 m should be employed. This value is based on the general assumption that runway visual range is 1.5 times greater than the visibility.

This two step method may be employed because of a mutual dependency of the occurrence of low visibility and low velocity winds, i.e. ‘when there is a fog, no strong wind blows’, has been effectively proven with a high probability.

Table 3–2 Precision approach categories

		ICAO	FAA	JAA
CAT I	DH	200ft ≤ DH	200ft ≤ DH	200ft ≤ DH
	RVR	550m ≤ RVR 1800ft ≤ RVR or 800m ≤ VIS 2400ft ≤ VIS	550m ≤ RVR 1800ft ≤ RVR	550m ≤ RVR 1800ft ≤ RVR 550m–1100m ≤ VIS ²
CAT II	DH	100ft ≤ DH < 200ft	100ft ≤ DH < 200ft	100ft ≤ DH < 200ft
	RVR	350m ≤ RVR 1200ft ≤ RVR	350m ≤ RVR < 800m 1200ft ≤ RVR < 2400ft	300m ≤ RVR 1000ft ≤ RVR
CAT III A	DH	No DH or DH < 100ft ¹	No DH or DH < 100ft ¹	DH < 100ft ¹
	RVR	200m ≤ RVR 700ft ≤ RVR	200m ≤ RVR 700ft ≤ RVR	200m ≤ RVR 700ft ≤ RVR
CAT III B	DH	No DH or DH < 50ft	No DH or DH < 50ft	No DH or DH < 50ft
	RVR	50m ≤ RVR < 200m 150ft ≤ RVR < 700ft	50m ≤ RVR < 200m 150ft ≤ RVR < 700ft	75m ≤ RVR < 200m 250ft ≤ RVR < 700ft
CAT III C	DH	No DH	No DH	
	RVR	No RVR limitation	No RVR limitation	

¹/ DH ≥ 50ft if fail passive

²/ When RVR is not available, conversion of the visibility to an RVR value is made. The selection of the conversion factor of 1.0, 1.5 or 2.0 is based on day/night conditions and the available lighting system.

The evaluation of the usability factor with the wind effect may be performed by any of the known methods, for example the Durst method described above.

For evaluation of the usability factor taking account of the runway visual range limits, the method of least squares, the approximation of accumulated occurrences of visibility by the means of a

polynomial, is employed. The method allows the usability factor to be evaluated with respect to the visibility limits in an arbitrary season and a time interval of a day, and may describe the time dependency (daily and yearly) of occurrences of low visibility.

The resultant usability of the aerodromes is the sum of the loss of usability due to the wind effect and the loss of usability due to the runway visual range limits.



Figure 3-4 Part of RVR equipment in touchdown zone (ILS GP antenna behind)
(Photo: A. Kazda)

According to Annex 14 Volume I, the ICAO precision approach runway categories are defined by decision height (DH) and runway visual range (RVR), or visibility in case of Category I (see Table 3-2). The criteria in ICAO, FAA and JAA standards are slightly different. ICAO standards are accepted world-wide, but additional requirements or other differences could be found for instance in FAA AC 120.29 and AC 120.28C or in the ECAC Doc 17. Category II weather minima permit manual landing, but it does not mean that automatic landings can not be made.

In any case the decision height or RVR cannot be lower than specified limits. ICAO defines the decision height (or altitude) and the runway visual range as:

Decision altitude (DA) or **decision height (DH)** is the specified altitude or height in the precision approach or approach with vertical guidance at which a missed approach must be initiated if the

required visual reference to continue the approach has not been established.

Runway visual range (RVR) is the range over which the pilot of an aircraft on the centre line of a runway can see the runway surface markings or the lights delineating the runway or identifying its centre line (Figure 3-4).

According to the European Guidance Material on Aerodrome Operations under Limited Visibility Conditions, EUR Doc 013 (April 2005), Low Visibility Procedures (LVP) are required for approach and landing operations in Category II or III weather conditions or for departures in RVR less than a value of 550 m. Precision approaches during Category I conditions do not require Low Visibility Procedures. For many regional airports with only moderate traffic a so called ‘full’ Category I (runway equipped with inset centre line lights) may represent a good solution before introducing any lower category, as the difference in operational limits between Category I and II is only 200 m of RVR.

Under JAR – OPS, take-off on a runway where the RVR is less than 400 m is also considered as a low visibility operation, in this case the Low Visibility Take-Off (LVTO). In some states it is mandatory to conduct a so called guided take off if RVR is 125 m or less (150 m for Cat D aircraft). In this type of operation a guidance system provides directional guidance information to the pilot during the take-off. However, the pilot may request to conduct a guided take off at any time. The ILS localiser guidance signal must be protected for these types of operation.

For Category I operations and non-precision approaches, RVR measurements must be provided in the touchdown zone. For Category II a second, mid-runway position must be equipped for RVR measurements and for the majority of Category III operations it is also required at the final third of the runway.

In fact, the critical value for a pilot in the final stages of approach and during flare is not RVR but the Slant Visual Range (SVR). Slant visual range is the range over which a pilot of an aircraft can see the markings or the lights as described in the RVR definition. The pilot’s ability to obtain visual reference in low visibility conditions is further constrained by the front section of the aircraft, the cockpit cut-off angle. Minimum visual segments at DH are established for each precision approach category. Typically the values are 225 m for Category II with manual landing, 90 m for Category II with automatic landing and 60 m for Category III. In Category III conditions a pilot can see the runway lights only about 5 seconds before touchdown.

Relationship between SVR, DH, cockpit cut-off angle and the visual segment are defined by a formula (Figure 3-5):

$$\text{SVR} = \sqrt{(v + (h \cdot \cot w))^2 + h^2}$$

where:

- v - visual segment
- h - pilot's eye above the ground
- w - cockpit cut-off angle = down vision angle – pitch angle

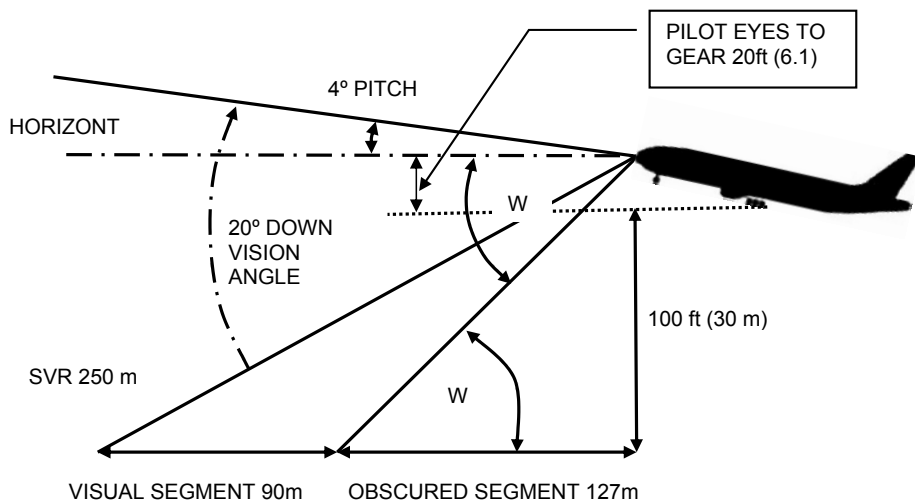

Figure 3-5 Visual ground segments and cut-off angle – landing approach
 (Source: Airbus Industry)

The main objective of Category II or III operations is to guarantee the same level of safety as during other operations, but in lower visibility and more adverse weather conditions. The desired level of safety is achieved (at the airport) by controlling:

- physical characteristics of runway, runway strip and the terrain before threshold
- obstacle clearance criteria
- visual aids (runway marking, lighting systems)
- non-visual aids (ILS or MLS facility)
- RVR measurements
- ATC procedures
- airport maintenance procedures.

The details of particular airport systems or equipment with respect to the low visibility procedures are discussed in the relevant chapters (e.g. Chapter 15 – Visual aids for navigation, Chapter 16 – Electrical energy supply, etc.).

Before the safety assessment study itself, the runway, runway strips and taxiway system layout must be examined for obstacle clearances. The most stringent area is inside the Obstacle Free Zone (OFZ). It is defined in ICAO Annex 14 as the airspace above the inner approach surface, inner transitional surfaces, and baulked landing surfaces and that portion of the strip bounded by these surfaces, which is not penetrated by any fixed obstacle other than a low-mass and frangibly mounted obstacle required for air transportation purposes (Figure 3-6). During Category II or III operations, taxiing or aircraft holding for take-off must also be kept out of the OFZ.

Figure 3-6 *Inner approach, inner transitional and baulked landing obstacle limitation*

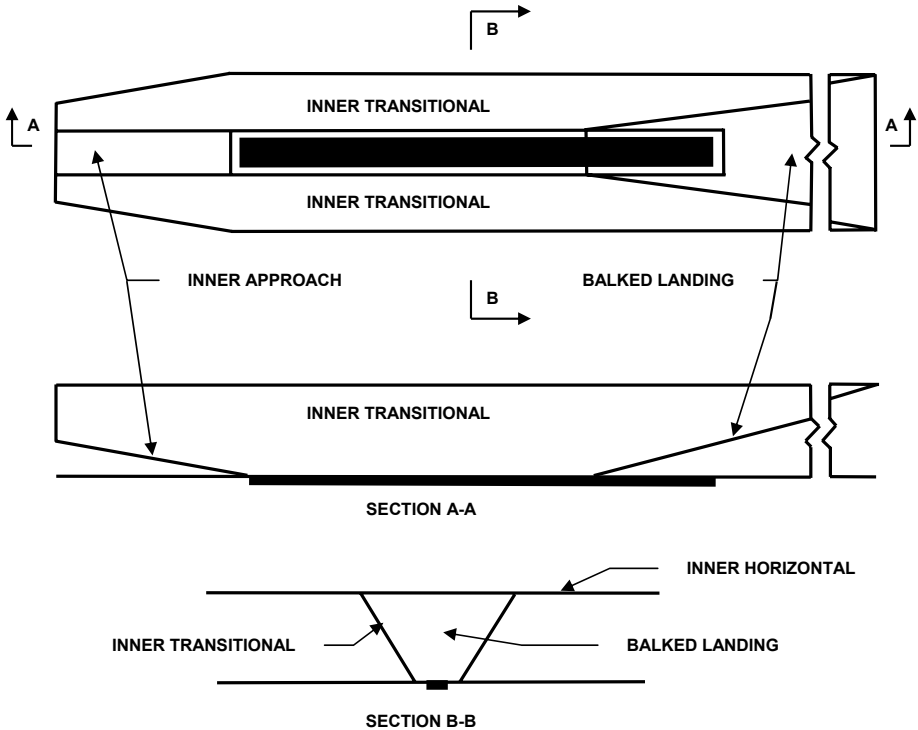

surfaces (Source: Annex 14, Volume I)

During low visibility operations it is of paramount importance to ensure the movement areas' sterility against incursions in order to guarantee safety of aircraft operations and the highest quality of guidance signals for automatic landings. In most cases, Instrument Landing Systems (ILS) or Microwave Landing Systems (MLS) are used for navigation guidance (see Chapter 17). Apart from the technical parameters of the navigation installation, the quality of signals is guaranteed by protecting critical and sensitive areas.

The ILS signal in space can be reflected and distorted by structures at the airport and its vicinity

but also by fixed or moving objects like vehicles, flying or taxiing aircraft or even pedestrians. Many potential conflicts can be eliminated by restrictions on the number and the type of movements. The ILS critical areas must be protected at all times while the ILS sensitive areas, which are larger than the critical areas, should be kept clear during category II or III operations to protect the signal against interference caused by moving objects. The dimensions and the shape of critical and sensitive areas depend on the terrain and objects around the airport and in the approach area, as well as on the parameters, configuration and the type of ILS. The MLS critical and sensitive areas are much smaller than those for ILS operations and in fact they place no restrictions on aircraft taxiing or taking-off, or on other movable objects.

During low visibility ILS operations the runway capacity is mainly constrained by the need to protect ILS critical and sensitive areas. To ensure guidance signal integrity it is necessary to provide appropriate spacing between two successive landing or departing aircraft. Landing clearance is normally given to an aircraft on approach when the ILS localizer sensitive area is clear, usually when the aircraft on approach is not closer than two nautical miles from touchdown. The runway capacity can be further restricted during Category III operations because pilots need more time to exit the runway and critical areas, and air traffic controllers may need to ensure an additional longitudinal separation for an approaching aircraft.

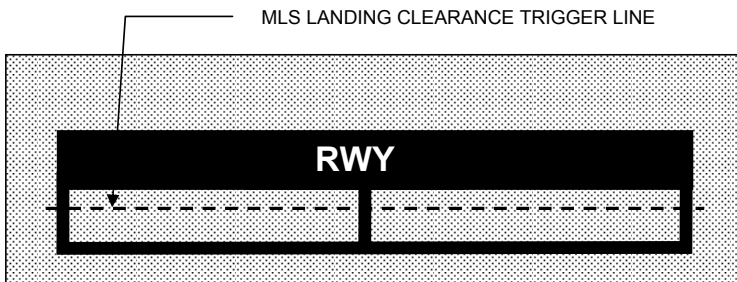

Figure 3-7 *MLS Landing Clearance Trigger Line* (Source: ICAO Doc 13)

MLS has smaller critical and sensitive areas around the runway. This removes some runway operational and capacity restrictions. Spacing between aircraft can be smaller and is determined by the rule that the preceding landing aircraft is clear of the so called ‘MLS Landing Clearance Trigger Line’. The MLS Landing Clearance Trigger Line is not marked on the airport movement areas but only on a controller’s display, e.g. surface movement radar or A-SMGCS (Figure 3-7). However, aircraft spacing can never be less than the wake turbulence separation.

Ground operations of aircraft and ground equipment during limited visibility conditions are more demanding as visibility decreases. During Low Visibility Operations, i.e. during Category II or III operations, special procedures must be activated against movement area incursion by vehicles or

personnel. Safeguarding the airside sterility is assisted by security fencing around an airport and by strictly controlled access points. The airside sterility is needed not only to protect the guidance signals in critical or sensitive areas but also to ensure safety of aircraft taxiing, landing or taking off.

At busy airports, surveillance of the manoeuvring area by a surface movement radar or A-SMGCS is also required. At airports with light or medium traffic density, surface movements control on a system of well segregated taxiways could be based on procedural methods. The required equipment and procedures for ground movement control depend on the aerodrome operating minima and the extent of the possible conflicting traffic, the size and complexity of the manoeuvring area and the movement rate required. For Category II or III operations all personnel involved must be properly trained and regularly tested under real or simulated low visibility conditions. This includes knowledge of the airport layout, radio-telephony and emergency procedures. All vehicles entering the manoeuvring area must obtain an authorisation from the control tower and they must maintain a permanent two-way radio communication. Special attention is given to the rescue and fire fighting personnel training for low visibility operations (see Chapter 19 - Airport emergency services).

Preparation for low visibility procedures starts when the visibility decreases to a predetermined limit, and it is expected to fall further. The initiation criteria are defined in the airport LVP manual and is based on the prevailing meteorological and operational conditions, for example when the visibility falls below 1 200 m or the cloud ceiling is below 300 ft. LVP must be running at the latest before the weather falls below Category I limits. However, if the weather deteriorates rapidly, the procedures could be started at higher limits depending on the operational experience and how long the preparation phase usually takes. The initiation and termination of low visibility procedures are decisive from the operational point of view and they are critical for predetermining the optimum airport capacity. Most problems can occur during these phases. In particular at busy airports the capacity restrictions can have an impact long after the LVP are terminated. Close co-ordination between the airport operator, meteorological office, air traffic control and air traffic flow management is necessary to minimise delays and a smooth return to full capacity after the termination of LVP. At large airports with a considerable share of long-haul flights the commencement of low visibility procedures can start more than 12 hours in advance.

3.4 CONTROL OF OBSTACLES

In the complex orographical conditions of mountainous countries, the appropriate runway orientation to minimise the crosswind is often coincident with the orientation designed with regard to obstacles. This is likely because the direction of the prevailing winds often coincides with the

centre line of a valley. Even so, the obstacle limitation surfaces may well be penetrated by obstacles. Development at many airports, particularly extending the runway, is often difficult because of obstacles. The defined obstacle-free airspace is an inseparable part of each aerodrome and should permit the intended aeroplane take-off, approach, landing and operation in the aerodrome circuit to be conducted safely. According to Annex 14 Volume I, obstacles are defined as all fixed (temporary or permanent) and mobile objects, or parts thereof, that are located on an area intended for the surface movement of aircraft or that extend above a defined surface intended to protect aircraft in flight.

The airspace round the airport is defined by a system of obstacle limitation surfaces. The characteristics of obstacle limitation surfaces are specified on the basis of types of airports (transport, general aviation, heliports, etc.) and are related to the intended use of the runway in terms of take-off, landing and the type of approach (non-instrument approach, non-precision or precision approach).

In cases where operations are conducted to or from both directions, then the function of certain obstacle limitation surfaces or parts of them may be nullified because of more stringent requirements of other lower obstacle limitation surfaces. Dimensions and slopes of obstacle limitation surfaces were derived from the performance characteristics of the various types of aeroplanes and from the statistical probability of deviations of the aeroplanes' trajectories relative to the intended flight path. Characteristics of obstacle limitation surfaces correspond to the requirements of the regulations for flight operations, air traffic control and aircraft airworthiness. Even in the most extreme foreseen position of the aeroplane, the prescribed minimum horizontal and vertical distance of the aeroplane from obstacles should be maintained.

Usually the significance of any object in the airport surroundings is assessed by two separate groups of basic criteria. The first one refers to the obstacle limitation surfaces for the particular runway and its intended operation. Annex 14 Aerodromes, Volume I, Aerodrome Design and Operations is used in many states as a legal and technical basis for this kind of assessment. The objective of the obstacle limitation surfaces is to define the airspace around aerodromes to be maintained free from obstacles so as to permit the intended aeroplane operations at the aerodromes to be conducted safely and to prevent the aerodromes from becoming unusable by the growth of obstacles around the aerodromes.

The second set of criteria relates to the Procedures for Air Navigation Services – Aircraft Operations (PANS –OPS) Doc 8168 Volume II Construction of Visual and Instrument Flight Procedures. Surfaces defined by this standard guarantee obstacle free airspace for instrument and visual flight procedures by specifying minimum safe heights / altitudes for each segment of the procedure. The limits depend on the installed navigational equipment, its type and position and

also on the speed of an aircraft. Some states use also other criteria and practices in line with their national standards and recommended practices, building code or other bylaws.

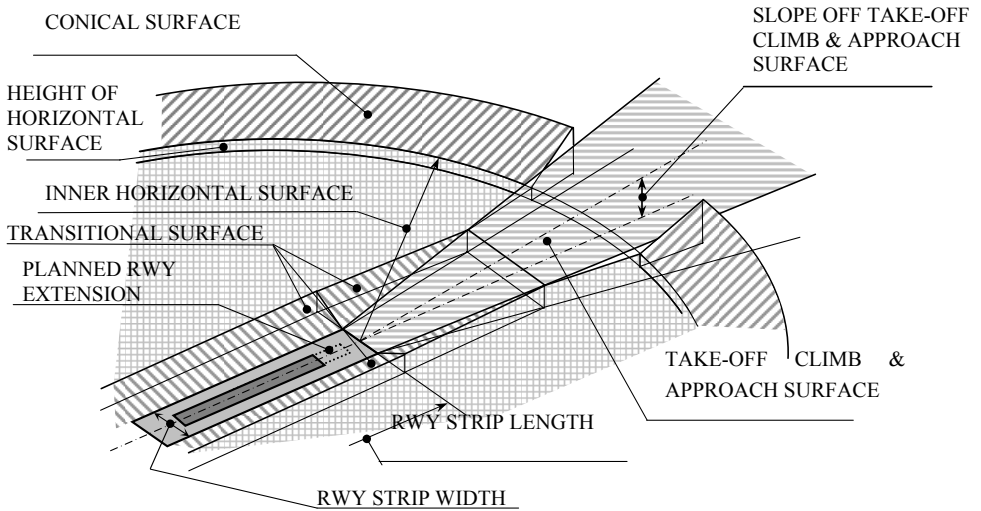

Figure 3-8 *Obstacle limitation surfaces*

The system of obstacle limitation surfaces as presented in Annex 14, Volume I, Chapter 4. ‘Obstacle restriction and removal’ also serves to advise a local authority of the height limits for new objects that might otherwise restrict or endanger the operations of aeroplanes in the future. If there is a potential conflict, the relevant aviation authority should be consulted.

For non-instrument runways, for instrument approach runways and for Category I precision approach runways, the following system of obstacle limitation surfaces has been specified (Figure 3-8):

- conical surface
- inner horizontal surface
- approach surfaces
- transitional surfaces
- take-off climb surfaces.

Table 3-3 Parameters of obstacle limitation surfaces for precision Category II or III RWY

SURFACE	DIMENSIONS
CONICAL	
→ Slope	5 %
→ Height	100 m
INNER HORIZONTAL	
→ Slope	45 m
→ Height	4 000 m
INNER APPROACH	
→ Width	120 m
→ Distance from THR	60 m
→ Length	900 m
→ Slope	2 %
APPROACH	
→ Length of inner edge	300 m
→ Distance from THR	60 m
→ Divergence	15 %
First section	
→ Length	3 000 m
→ Slope	2 %
Second section	
→ Length	3 600 m
→ Slope	2.5 %
Horizontal section	
→ Length	8 400 m
→ Total length	15 000 m
TRANSITIONAL	
→ Slope	14.3 %
INNER TRANSITIONAL	
→ Slope	33.3 %
BALKED LANDING SURFACE	
→ Length of inner edge	120 m
→ Distance from threshold	1800 m
→ Divergence	10 %
→ Slope	3.33 %
TAKE-OFF CLIMB	
→ Length of inner edge	180 m
→ Distance from RWY end	60 m
→ Divergence	12.5 %
→ Final width	1 200 (1 800) m ¹
→ Total length	15 000 m
→ Slope	2 %

1/ 1 800 m when the intended track includes changes of heading greater than 15° for operation conducted in IMC, VMC by night.

The most significant differences in characteristics between these classes of runway are related to the dimensions and slopes of the take-off climb and approach surfaces. The necessary data may be found in Annex 14.

The system of obstacle limitation surfaces for precision approach runway Category II and III is supplemented by:

- inner approach surface
- inner transitional surfaces
- balked landing surface.

These three surfaces define the so called Obstacle Free Zone for operations which are conducted in the low visibility conditions and strictly limit the existence of all fixed objects other than low-mass and frangibly mounted objects required for air navigation purposes. The dimensions and slopes of all the relevant surfaces for precision approach Category II or III are specified in Table 3-3. The determinants for assessing the consequences of a certain obstacle penetrating a surface are the type of operation on the runway in question, the position of the obstacle (which surface is obstructed by the obstacle, the distance from the runway threshold/end and how much it obstructs it) and its character (hill, aerial transmission line poles, road profile, etc).

As a reaction to increased regular use of helicopters in civil aviation, ICAO published Annex 14, Volume II, Heliports in 1990 for the first time. Specifications on obstacle restriction and removal are given in Chapter 4 of these Standards and Recommended Practices. In the case of ground level heliports, the system of obstacle limits is similar to surfaces defined in Annex 14, Volume I, but it respects the specifics of helicopter operations. For non-instrument final approach and take-off area (FATO)¹, two obstacle limitation surfaces are established:

- take-off climb surface
- approach surface.

For a precision (Figure 3-9) or a non-precision approach FATO two other surfaces are defined:

- transitional surfaces
- conical surface.

¹ Final approach and take-off area (FATO) is a defined area over which the final phase of the approach manoeuvre to hover or landing is completed and from which the take-off manoeuvre is commenced. FATO is similar to the Runway Strip of 'classic' aerodromes.

For ground level or elevated heliports there is a requirement to establish a minimum of two takeoff climb and approach surfaces which are separated by at least 150° to guarantee the usability of the heliport with respect to prevailing wind conditions. The total length of approach surface is 10 000 m for a 3° standard precision approach FATO, or 8 500 m for a 6° approach. In the case of a non-instrument and non-precision FATO, the approach surface dimensions are based on a multiple of helicopter rotor diameters.

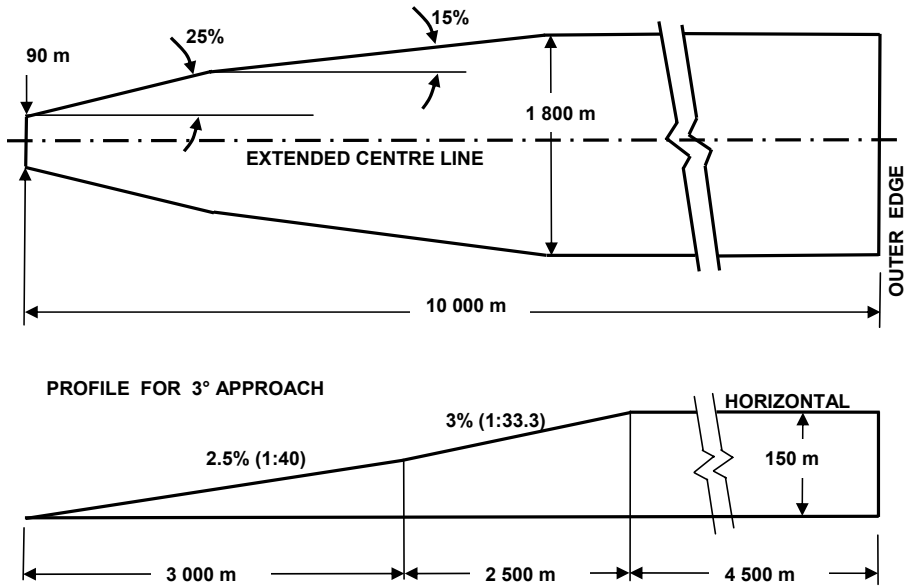

Figure 3-9 Approach surfaces for precision approach FATO - 3° approach

(Source: Annex 14, Volume II)

The general opinion is that everything that exceeds specified limits around an airport is an obstacle and must be banned. It might be true, but not always. Another common view is that if an object does not penetrate a defined surface, the object is not considered to be an obstacle. This also might be true but also not always. The principal problem is that no two airports and no two obstacles are alike. Because of this it is not possible to give a simple rule for an objective assessment. To consider all aspects of the problem, most states require an aeronautical study as a prerequisite for obstacle assessment. The Aviation Authority may still allow operations on the basis of a study, often using the ICAO Collision Risk Model.

To evaluate the effect of obstacles on precision instrument approach operations (ILS or MLS), the following obstacle assessment procedure is generally accepted: when ICAO ANNEX 14 obstacle

assessment surfaces are penetrated, Obstacle Assessment Surfaces (OAS) as defined in ICAO Doc 8168 Volume II are used in lieu of ICAO ANNEX 14 surfaces. When even OAS are penetrated, the Collision Risk Model (CRM) is utilised. However, in the latter case, the complete obstacle situation in the vicinity of the aerodrome has to be fully transformed into the CRM format, as the risk corresponding to each individual obstacle contributes to the cumulative risk of the approach.

There is no common world wide methodology for obstacle assessment in the vicinity of airports and states are using different practices for this purpose. ICAO prepared Doc 9137-AN/898/2 Airport Services Manual, Part 6 — Control of Obstacles as guidance material. This manual contains a detailed examination of the control of obstacle at an airport but it also reviews some states practices.



Figure 3-10 *Marking high tension transmission lines (Photo A. Kazda)*

Obstacles in the take-off climb and approach surfaces and in the transitional surfaces are assessed most stringently. The construction of new obstacles or extensions of existing obstacles shall not be permitted if they would penetrate the Annex 14 surfaces. It is, however, not always possible to eliminate the occurrence of obstacles. Then it is necessary to determine special procedures such as offset approach or take-off trajectory, or install special equipment for the runway, or limit the runway operation with higher visibility and ceiling operating limits as well as marking and lighting the obstacles.

If the obstacles only penetrate the conical surface or the inner horizontal surface, less stringent criteria are used. Even in that case, for an assessment of a specific obstacle, the location and character of the obstacle are important.

It is necessary to investigate whether the obstacle is shielded by an existing immovable object, or to prove by an aeronautical study that the object would not adversely affect the safety or the regularity of operations of aeroplanes.

Some objects may be considered particularly dangerous and should be removed or at least marked even if they do not obstruct any obstacle limitation surfaces. They are, in particular, isolated thin objects such as chimneys, poles and posts, or aerial high and extra-high tension transmission lines in the approach and take-off climb surfaces. The Aviation Authority may order removal (e.g. trees) or marking (e.g. aerial high tension transmission line – Figure 3-10) of any object that might after aeronautical study endanger aeroplanes on the movement area or in the air. The object should generally be removed by its owner, not by the aerodrome operator. Marking of objects which extend to a height of 150 m or more above ground elevation is compulsory.

3.5 OTHER FACTORS

Though the system of take-off and landing runways and taxiways represents the greatest demands for space, the options are often very limited. Therefore, in planning an airport, the take-off and landing runways and taxiways are usually designed first. The capacity of the runway system is a limiting factor of further development of the largest airports. In many cases, further expansion of the airport is impossible due to public opposition. Even if approval is eventually given, it may take more than a decade to implement the construction or extension of a new runway.

The capacity of the terminal airspace and of the runway system of the airport may be assessed with computer simulations, analytical models or handbook methods. There are several different simulation models and each of them has some special features. The most known are the following:

The Airport and Airspace Simulation Model (SIMMOD™), was validated by the Federal Aviation Administration (FAA) as a standard analysis tool for airport planners, airport operators, airline companies, airspace designers and air traffic control authorities for airport and airspace operations.

Total Airspace & Airport Modeller (TAAM) was developed by Preston Aviation Solutions (a Boeing Company subsidiary) in cooperation with the Australian Civil Aviation Authority (CAA). TAAM is a large scale fast-time simulation package for modelling entire air traffic systems. It can be used for ATM analysis and feasibility studies or for planning purposes. The advantage of this

tool is that it can simulate complete gate to gate operations and in more detail than comparable models, but at considerable expense.

The Airport Machine is a simulation tool from the Airport Simulation International (ASI) company. It can be used for detailed simulations of movement areas operations. It is based on a node-link structure similar to that of SIMMOD, and it covers all aircraft activities from a few minutes before landing until a few minutes after take-off.

The Total AirportSim was developed by IATA. It is designed for simulations of the whole airport operations including passenger terminal, gate, apron, runway and airspace. It provides realistic results. The model is designed to offer a comprehensive solution that covers a wide variety of demand/capacity and level of service applications for the simulation of aircraft and passenger flows.

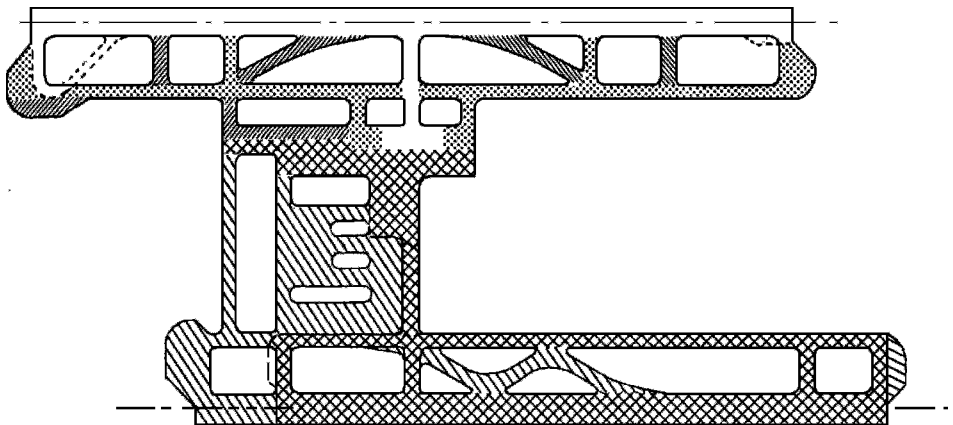





- Level at which to build
-  Up to 20 000 to 30 000 operations
 -  30 000 to 60 000 operations
 -  50 000 to 99 000 operations
 -  75 000 to 150 000 operations
 -  150 000 to 250 000 operations

Figure 3-11 Typical phased development of airport

(Source: ICAO Airport Planning Manual)

Rams Plus solution is a product from ISA Software. This company is a part of the ISA Research Group, which offers ATM analysis to customers like FAA and EUROCONTROL. The RAMS Plus gate-to-gate system has two main parts, the Airside and the Groundside, which function together in the same environment to provide a global macro/micro gate-to-gate view of the air traffic system.

It is also possible to carry out simulations of parts of the manoeuvring area using e.g. Monte Carlo techniques. The crucial factor, whether the models are simple or comprehensive, is the quality of the data used for calibrating the model, e.g. runway occupancy time by type of aircraft and meteorological condition. The budget is another factor. Some of the tools can take weeks to load all the airport data, even after the prolonged process of capturing the operational data.

FAA Airfield Capacity Model is a handbook method for assessing the runway and the manoeuvring areas. According to the FAA, it is possible to define the runway capacity as the maximum number of movements within an hour once the tolerable delay has been defined. It tends to give better estimates of capacity for operations similar to those in the USA.

The magnitude of an acceptable delay differs at individual aerodromes. From the maximum number of movements in an hour, it is possible to derive the daily and yearly capacity of the runway system. Figure 3-11 illustrates how the FAA suggests that capacity should be enhanced with the growth of the airport in terms of the number of movements in a year. It should be emphasised that this was developed for US airports. Different economic environments and mixes of traffic might well expand more slowly.

Figure 3-12 illustrates how the capacity varies with the runway configuration

On one runway with a optimum layout of taxiways and with a sufficient capacity of the apron, it is possible to reach up to 252,000 air transport movements in a year, as at London Gatwick in 2005, even using Instrument Flight Rules (IFR).

The decision to construct another runway depends not only on the annual runway capacity but also on the magnitude of the peak hour traffic and the type of operation ('hub and spoke' or 'point to point'), as well as on an assessment of other factors which, if they occurred, would bring about a complete shut down of an airport with one runway. These might be an accident, an unlawful act of intervention in an airport or an aeroplane, winter maintenance of the runway, etc.

The design of systems of taxiways is dealt with in Chapter 6: Taxiways.

At many airports there is a prohibition or a limitation against operations at night. These night curfews, as in Tokio's Narita airport, cause further intensification of peak hour traffic. Limitations of the number of movements with respect to the noise load from particular types of aircraft are in force at a number of airports, e.g. Munich, Düsseldorf and the London airports. There are also limitations of the number of movements with respect to the level of air pollution as in Zürich and Stockholm's-Arlanda, and other administrative limitations. Chapter 20 of this book deals with the problems of environment protection and ecological limitations.



Number	Runway use configuration	Hourly capacity ops/h		Annual service volume
		VFR	IFR	
1		51 - 98	50 - 59	195 000 - 240 000
2		94 - 197	56 - 60	260 000 - 355 000
3		103 - 197	62 - 75	275 000 - 365 000
4		103 - 197	99 - 119	305 000 - 370 000
5		72 - 98	56 - 60	200 000 - 265 000
6		73 - 150	56 - 60	220 000 - 270 000
7		73 - 132	56 - 60	215 000 - 265 000

Figure 3-12 *Hourly capacity and annual service volume*
 (Source: ICAO Airport Planning Manual)

4

RUNWAYS

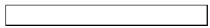
Tony Kazda and Bob Caves

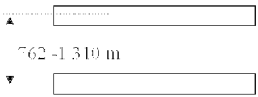
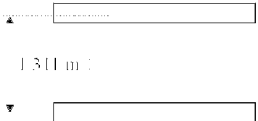
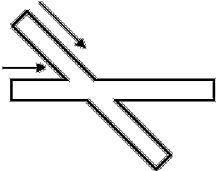
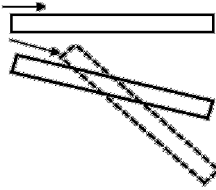
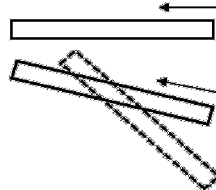
4.1 AERODROME REFERENCE CODE

As with other Annexes, the main objective of Annex 14 is to determine criteria for providing world-wide security, regularity and economy of international air transport.

Many provisions which are included in Annex 14 are of a universal character and are applicable to the majority of personnel in international air transport, its procedures and equipment. However, some of the provisions are applicable only to specific types of operation, or depend on critical dimensions or performance characteristics of the given aeroplane.

The main task is to achieve an effective and efficient relationship between particular facilities and aeroplanes. Since there are many types and models of aeroplanes in operation, it would be practically impossible to develop specific facilities for each of the types of aircraft in common use, with all the variations in size and in numbers and location of engines. In Annex 14, there are therefore many facility sizing criteria related to the most demanding (critical) type of aeroplane or group of aeroplanes that may be used in the airport. The established system of aerodrome reference code (Table 4-1) results from that principle in Annex 14.

Table 4-1 Aerodrome reference code

Code element 1		Code element 2		
Code Number	Aeroplane reference field length	Code letter	Wing span	Outer main gear wheel span / ^a
1	Less than 800 m	A	Up to but not including 15 m	Up to but not including 4.5 m
2	800 m up to but not including 1 200 m	B	15 m up to but not including 24 m	4.5 m up to but not including 6 m
3	1 200 m up to but not including 1 800 m	C	24 m up to but not including 36 m	6 m up to but not including 9 m
4	1 800 m and over	D	36 m up to but not including 52 m	9 m up to but not including 14 m
		E	52 m up to but not including 65 m	9 m up to but not including 14 m
		F	65 m up to but not including 80 m	14 m up to but not including 16 m

a/ Distance between the outside edges of the main gear wheels.

Source: ICAO Annex 14, *Aerodromes, Volume I, Aerodrome Design and Operation 4th edition*

Establishment of the Aerodrome Reference Code in Annex 14 pursues three purposes with regards to:

1. Design **to provide aerodrome designers with guidelines** on how to plan and design an aerodrome by **relating** rational design criteria with current and future aeroplanes' requirements
2. Standard **the aerodrome reference code** is a simple method for **interrelating the numerous specifications** concerning the characteristics of aerodromes
3. Operation the aerodrome reference code serves as an indication of the characteristics of the ground facilities, so the prospective **aircraft operator may contemplate whether aerodrome facilities are suitable** for that aircraft to operate there, provided that Annex 14 was complied with during its construction (this is only valid for movement areas).

When the aerodrome reference code was designed, it was decided that it had to consider the aeroplane operational characteristics and geometrical dimensions.

The following parameters may be given as examples of the operational characteristics:

- take-off and landing distances
- approach speed
- nose wheel lifting speed
- glide slope angle
- climb rate
- taxiing speed
- turning radius
- engine exhaust jet blast velocity.

Examples of geometrical dimensions of aeroplane:

- wing span
- distance between the engines and the main undercarriage
- outer main gear wheel span
- distance between the nose wheel and the main undercarriage
- height of pilot's eyes above the ground
- aeroplane total length
- aeroplane height.

The aerodrome reference code is composed of two elements, and ICAO chose to use take off distance, wing span and gear span as the aeroplane indicators, as follows:

The first code element (indicated by numbers 1 to 4) is based on the aeroplane reference field length.¹ It refers to the critical aeroplane's normalised takeoff requirements, and relates in particular to the runway geometry and obstacle clearance limit aspects of the design. However, it does not control the actual required length of the runway. The FAA airport coding system uses the

¹ Footnote: Aeroplane reference field length is the minimum length required for the take-off at maximum certificated take-off mass at sea level, standard atmospheric conditions, still air and zero runway slope, as shown in the appropriate aeroplane flight manual prescribed by the certifying authority or equivalent data from the aeroplane manufacturer. Field length means balanced field length (the term balanced field length is explained hereinafter) if applicable, or a take-off distance in other cases. The ICAO documentation provides a listing of Reference Field Lengths.

approach speed to represent this dynamic part of the aircraft's characteristics.

The second code element (indicated by letters A to F) is based on the aeroplane geometrical characteristics. It is determined by a wing span and an outer main gear wheel span. It relates in particular with the provisions referring to taxiways and aprons sizes and spacing. Characteristics of some aeroplanes and their classification by code number and code letter are shown in the Table 4-2.

Table 4-2 Aeroplane characteristics and classification by code number and letter

Aircraft make	Model	Code	Aeroplane reference filed length [m]	Wing span [m]	Outer main gear wheel span [m]
Cessna	182 S	1A	462	11.0	2.9
Pilatus	PC-12	1B	452	16.2	4.5
DeHavilland Canada	DHC7	1C	689	28.4	7.8
Lear Jet	24F	2A	1 005	10.9	2.5
LET	L410 UVP-E	2B	920	20.0	4.0
Dassault Aviation	Falcon 10	3A	1 615	13.1	3.0
Bombardier Aero	CRJ 200	3B	1 440	21.2	4.0
Boeing	B737-600	3C	1 690	34.3	7.0
SAAB	340A	3C	1 220	21.4	7.3
Airbus	A300 B2	3D	1 676	44.8	10.9
Bombardier Aero	CRJ 200LR	4B	1 850	21.2	4.0
Embraer	EMB-145 LR	4B	2 269	20.0	4.1
Airbus	A320-200	4C	2 480	33.9	8.7
Boeing	B737-500	4C	2 470	28.9	6.4
Airbus	A310	4D	1 845	44.8	10.9
Tupolev	TU154	4D	2 160	37.6	12.4
Boeing	B747-300	4E	3 292	59.6	12.4
Boeing	B777-300	4E	3 140	60.9	12.9
Airbus	A380	4F	3 350	79.8	14.3

Source ICAO Doc 9157-AN/901 Part 1 Third Edition - 2006 (Aerodrome design manual – Runways, Appendix 1 – Airplane classification by code number and letter)

Some provisions specifying the characteristics of movement areas are determined by a combination of both elements of the aerodrome reference code.

4.2 RUNWAY LENGTH

Determination of the runway length to be provided is one of the most important decisions both for designing an aerodrome, but also to allow economic operation of a particular type of aircraft to specific destinations. The runway length determines the types of aircraft that may use the aerodrome, their allowable take-off mass and hence the distance they may fly.

The number of new aerodromes for which runways have to be designed is limited. In the majority of cases the task is to extend existing runways or to provide supplementary runways. The basic requirements for the runway parameters may be specified from market research into the types of aeroplanes, the networks of the operating airlines and prognoses of further market development at the airport in question.

A runway extension often makes it possible to open the aerodrome to larger aeroplanes, and to longer flight sectors, so extending the market of the aerodrome. There is usually considerable flexibility in how an aircraft can reach its maximum operating mass, between the extremes of maximising fuel load with limited payload and maximising payload at the expense of fuel and hence range. Additionally, it may be that the sector to be flown does not require a full load of fuel, or that the passenger load factor is expected to be low, or there is likely to be little cargo. In these cases, the aircraft will not be at maximum take-off mass (MTOM), and hence may gain no economic advantage from a runway extension.

A payload range diagram is shown on the Figure 4-1. At the point A an aeroplane has maximum payload, but it has no range as it has zero fuel. The range of the aeroplane increases from A to B by loading fuel while the payload remains the same. The greater the fuel added to the airplane, payload being constant, the greater is the aeroplane mass. At the point B the aeroplane has the maximum take-off mass. From this point the range could be increased only by replacing each kilogram of payload by the same amount of fuel. At the point C the aeroplane has maximum capacity of fuel and the range could be further increased only by reducing the payload. The aeroplane mass decreases between C and D.

The first step in specifying the necessary runway length is to create a list of the aeroplanes that may wish to use the aerodrome after the runway extension and their likely destinations from the aerodrome. It is advisable to divide the aeroplanes into groups which are characterised by *take-off mass* and *payload*, each of the aeroplane groups requiring approximately the same runway length.

In the majority of cases, only a small group of aeroplanes requires the longest class of runway, or even only one aeroplane: the ‘critical’ aeroplane.

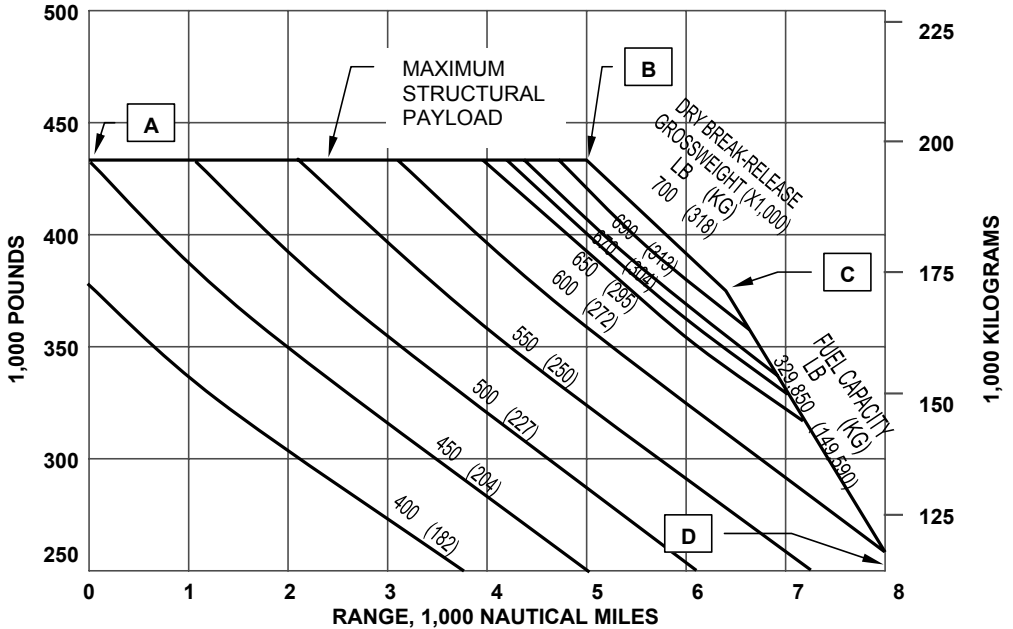

Figure 4-1 *Payload/range diagram*

The number of movements of a critical aeroplane is sometimes so small that there is no economic justification for extending the runway to meet its needs. In that case the operation of a critical type is usually still possible from the existing runway, though with a lowered payload, or reduced flying range, or both at some times of the day and year. However, the airlines will not use such an aerodrome if it would frequently require considerable reduction of the payload or limitation of the flying range.

A runway extension may also be economically unjustifiable because it is too technically demanding to construct it, because there are practically immovable obstacles in the take-off and approach areas or because the safety area would encroach on populated areas. In that case, a combination of runway and stopway, or runway and starter strip may allow the same take-off length to be provided. It is clear from the above that the determination of the required runway length is exacting, and any case of runway lengthening should be considered specifically for each case, taking all factors into account. It is necessary to consider not only the future development of the air transport market, but also changes in the prices of land, building materials, labour and

economic development as a whole. It is often sensible to buy land and make at least a territorial provision for a prospective extension of the runway. Another consideration is that airlines appreciate excess runway length so that they can operate reduced thrust takeoffs and so reduce engine wear. Also, the longer the runway the more it is possible to displace landing thresholds to keep aircraft higher over communities to reduce noise and improve safety. In any case, the overriding criterion is to provide the defined degree of safety of the aerodrome operation (see Table 4-3).

Table 4-3 Definitions of frequency levels and ‘acceptable’ numerical frequency ranges for each flight hour

Description	Estimate of frequency	Frequency per aircraft flight hour
Probable	Anticipated to occur one or more times during the entire operational life of each aeroplane.	more than 10^{-5}
Remote	Unlikely to occur to each aeroplane during its total operational life but which may occur several times when considering the total operational life of a number of aeroplanes of the type.	between 10^{-7} and 10^{-5}
Extremely remote	Unlikely to occur when considering the total operational life of all aeroplanes of the type, but nevertheless, has to be considered as being possible.	between 10^{-9} and 10^{-7}
Extremely improbable	So unlikely that they are not anticipated to occur during the entire operational life of all aeroplanes of one type.	less than 10^{-9}

Source: JAR AMJ 25.1309

The runway performance characteristics of the critical type of aeroplane may be obtained in several ways:

- using the parameters given in the flight manual of the aircraft type
- using the parameters given in the aircraft type’s airport planning manual (Aircraft Characteristics for Airport Planning) issued by all manufacturers of commercial aircraft.

Aeroplane performance characteristics are usually described as *measured*, *gross* and *net*.

Measured performance is obtained from tests of pre-production airplanes. However, these data are obtained from new aeroplanes flown by test pilots and must be further adjusted to match

everyday airline operation.

Gross performance is the average performance of an aircraft fleet in an airline company provided that the fleet is maintained, operated and flown in line with the flight manual and standards and recommended practices. The gross performance could be used as a reference but with no safety margins. Sometimes the gross performance is referred to as demonstrated (e.g. demonstrated landing distance).

Net performance is the gross performance reduced by a safety margin specified for airplane public transport operation. The safety margin required for public transport is based on an incident probability of one in one million flights (10^{-6}) making an incident a 'remote' possibility.

Table 4-4 JAR Aeroplane Performance Classification

Engine specification Parameter	Multi-engined	Propeller driven	
	Jet	Multi-engined Turboprop	Piston
MTOM: Greater than 5700 kg Passenger: More than 9	A	A	C
MTOM: 5700 kg or less Passenger: 9 or less	A	B	B

According to JAR – OPS different criteria for performance assessment are used for different *aeroplanes classes* (Table 4-4):

Performance Class A – includes multi-engine aeroplanes powered by turbopropeller engines with a maximum approved passenger seating configuration of more than 9 or an MTOM exceeding 5 700 kg, and all multi-engine turbojet powered aeroplanes.

Performance Class B – includes propeller driven aeroplanes with a maximum approved passenger seating configuration of 9 or less, and an MTOM of 5 700 kg or less.

Performance Class C – includes aeroplanes powered by reciprocating engines with a maximum approved passenger seating configuration of more than 9 or an MTOM exceeding 5 700 kg.

According to the JAR 25, Performance Class A aeroplanes have the strictest airworthiness but the least stringent operating regulations. These aeroplanes are allowed to operate in all weather conditions. Performance Class C aeroplanes are large piston powered aeroplanes which are not used frequently nowadays.

From the performance characteristics drawn in the charts (or tabulated) given in the flight manual

of the critical aircraft type, the landing distance, take-off distance and accelerate stop distance at the various feasible configurations of flap settings and airframe system availability can all be derived. The data are chosen to represent the given parameters of the aerodrome and the proposed operation. The parameters include the aerodrome altitude, outside air temperature, runway longitudinal slope, as well as the maximum likely aeroplane mass.

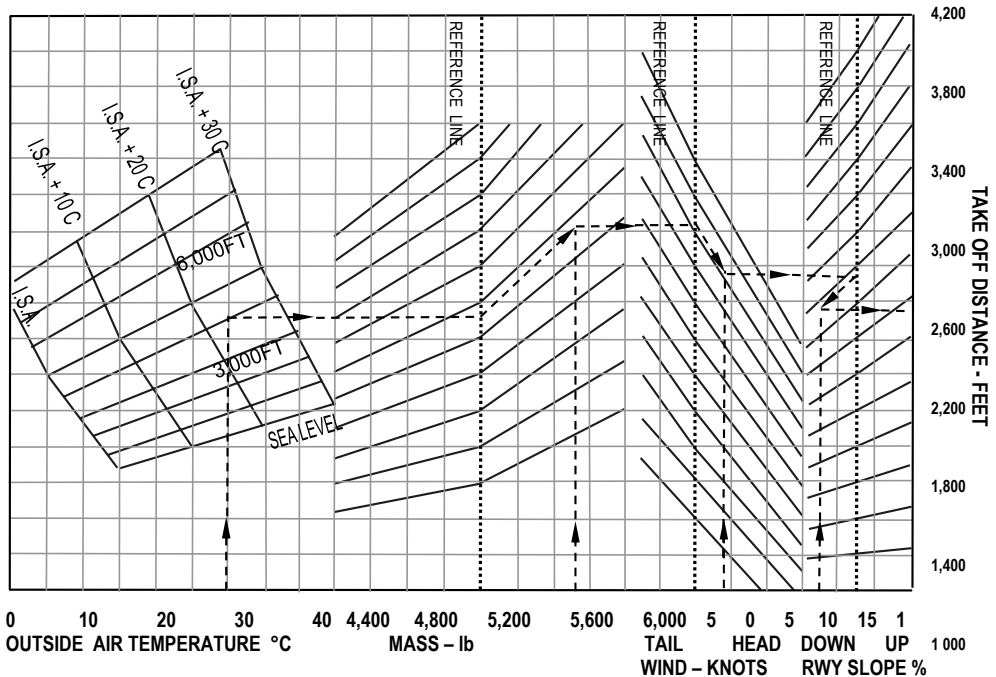

Figure 4-2 *Single engine piston aeroplane take-off distance*

The gross take-off distance of a single engine class B aircraft can be read from graph in Figure 4-2. The use of the graph is illustrated by arrowed broken lines.

The performance characteristics of the critical aeroplane at a particular aerodrome have to allow the aeroplane, with regards to the runway characteristics and actual meteorological conditions, either to complete the take-off safely, or to stop after aborted take-off. For all multi-engine airplanes for each take-off, a speed V_1 is defined, which is called the decision speed (sometimes called also critical speed), see Figure 4-3.

If an engine failure occurs at a speed lower than V_1 , the pilot shall abort the take-off. If the aeroplane has a greater speed than V_1 when the emergency is recognised the pilot shall continue the take-off with one engine inoperative. Trying to continue the take-off with an engine failed before

V_1 would require a very long take-off distance due to the reduced power available after an engine failure.

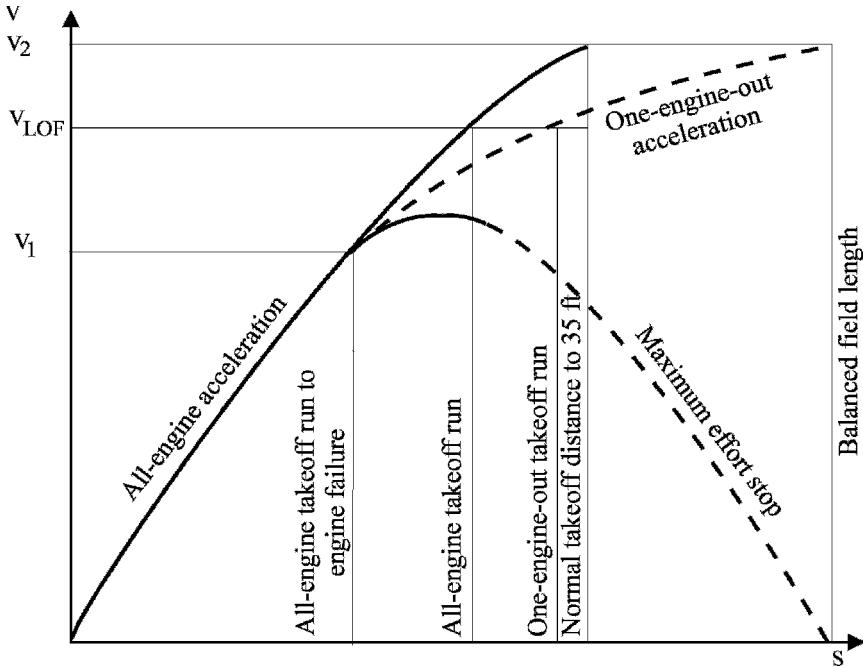

Figure 4-3 *Takeoff field length demonstration requirements for multiengine aircraft*

On the other hand, there would not have been any problem to stop the aeroplane in the remaining portion of the runway. With an engine becoming inoperative only after exceeding the speed V_1 , the aeroplane has a relatively high speed and the remaining power is sufficient for completing the take-off on the remaining runway. If the decision to abort the take-off is taken after exceeding the V_1 speed, the aeroplane speed would be so high that the aeroplane would need an excessive distance to stop safely in the remaining runway.

Decision speed is the speed chosen by the aircraft captain in relation to the respective limitations of the aircraft, the airline operator rules and procedures, runway characteristics and actual meteorological conditions. The accelerate-stop distance d_2 (Figure 4-4) is the sum of the take-off distance to reach the speed V_1 with all engines operating, the distance which the aeroplane travels during the pilot's reaction time (assumed reaction time for the purposes of performance calculations is 2 sec) and the braking distance until the aircraft comes to a full stop.

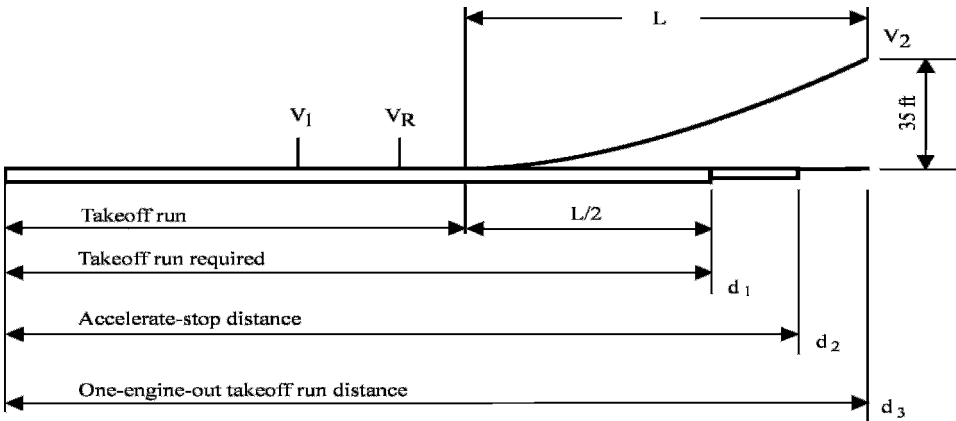

Figure 4-4 One engine-out takeoff/aborted takeoff

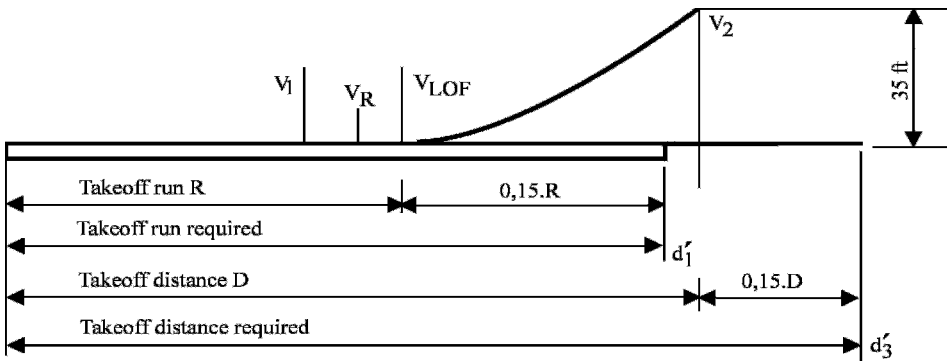

Figure 4-5 Takeoff-all engines

The take-off length with one engine inoperative, d_3 , is the sum of the distance with all engines operating until reaching the speed V_1 , the length of a further distance to lift off with one engine inoperative and the climb to the altitude 10.7 m (35 ft) (Figure 4-4) where the particular speeds are defined as:

V_1 Decision speed.

V_{MC} Minimum control speed, minimum speed at which critical engine failure may occur and still a straight flight is possible at this speed and is fully controlled. During the critical engine failure the operating engine causes asymmetric thrust which causes the yaw. According to JAR/FAR 25.149 maximum allowed lateral deviation from the RWY axis is 30 ft.

- V_R Rotation speed or speed at which the nosewheel lifts.
- V_{LOF} Lift-off speed, main gear lift-off (or unstick) speed.
- V_{MU} Minimum unstick speed, >minimum speed which allows safe continuation of take-off. The lowest speed at which an airplane can safely lift-off and continue the take-off climb.
- V_2 Take-off climb (or safety) speed $1.2 V_s$, (where V_s is a stalling speed for the take-off configuration), that must be reached at a height of at least 35 ft above the RWY surface in case of engine failure.

Other important limits and speeds which can be found in flight manuals and are related to airplane performance during take-off and climb are as follows:

- V_{MCG} Minimum control speed, on or near ground at which, when the critical engine is suddenly made inoperative, it is possible to maintain control of the airplane with the use of the primary aerodynamic controls alone (without use of nose-wheel steering) to enable the take-off to be safely continued using normal piloting skill.
- V_{EF} The speed at which the critical engine is assumed to fail to be afterwards recognised as “an engine failure” at V_1 . This means that V_1 is always higher than V_{EF} .
- V_{MBE} Maximum brake energy speed - the maximum speed from which a stop can be accomplished within the energy capabilities of the brakes.
- V_{STOP} The highest speed from which a take-off can be safely rejected for a given ASDA (for ASDA see 4.3).
- V_{GO} The slowest speed from which a take-off can be safely continued after an engine failure for a given TODA (for TODA see 4.3).

The required safe distance necessary for a take-off is considered to be whichever is the greater of:

- take-off distance with one engine inoperative - d_3
- 115 per cent of the demonstrated take-off distance with all engines operating d'_3 , (Figure 4-5).

If a lower V_1 is chosen, the take-off distance with one engine inoperative - d_3 (point 1) determines the necessary runway length; while with a higher V_1 chosen, the accelerate stop distance d_2 (point 2) is taken. If the 115 per cent of the take-off distance with all engines operating is so small that it lies under the point 3 (line a), the distance d'_3 has no effect upon the necessary take-off distance. However, if the 115 per cent of the take-off distance with all engines operating lies over the points 1 and 2 (line c), it is the only determinant for the take-off distance (Figure 4-6).

If it lies between the points 3 and 1, or 2 (line b), all the above named events may occur. The aircrafts' Airport Planning Manuals normally report only the most dominant of these criteria and

only consider the balanced engine-out field length where V_1 is chosen so the distance for take-off and rejected take-off are equal (Figure 4-6).

For a take-off with one engine inoperative, the hard runway part of the total available distance should be longer than the actual required take-off run. That distance shall be determined by the sum of the distance with all engines operating up to the speed V_1 , a further distance run with one engine inoperative up to the lift-off speed V_{LOF} and a half of the horizontal distance to climb up to 10.7m (35 ft) (Figure 4-4).

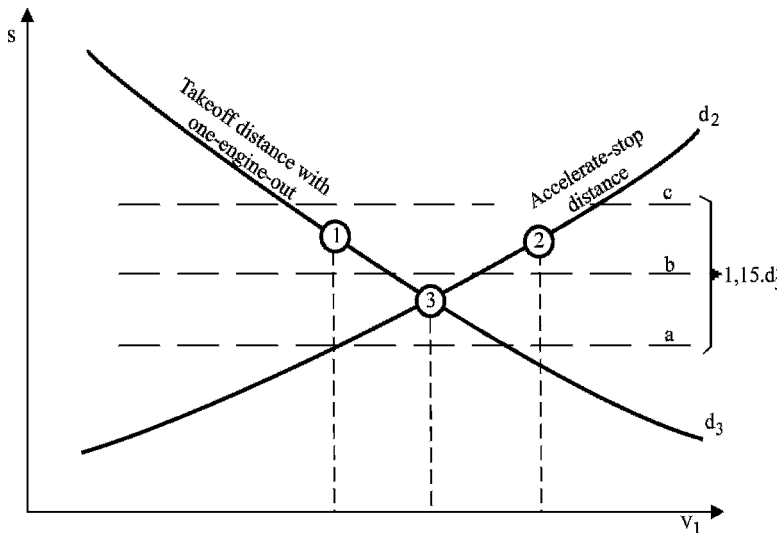

Figure 4-6 Effect of decision speed V_1 on takeoff distance, accelerate-stop distance and takeoff run

The distance necessary for a take-off run is considered to be whichever is the greater of:

- distance run with one engine inoperative plus half of the horizontal distance to climb to 10,7m (35 ft) - d_1
- 115 per cent of the take-off run with all engines operating - d'_1 .

When considering an aircraft operation on a particular runway there are also other factors and limitations. Generally, five areas that have take-off performance requirements can be identified. They are the following:

- field length
- climb
- obstacle clearance

- tyre speed
- brake energy.

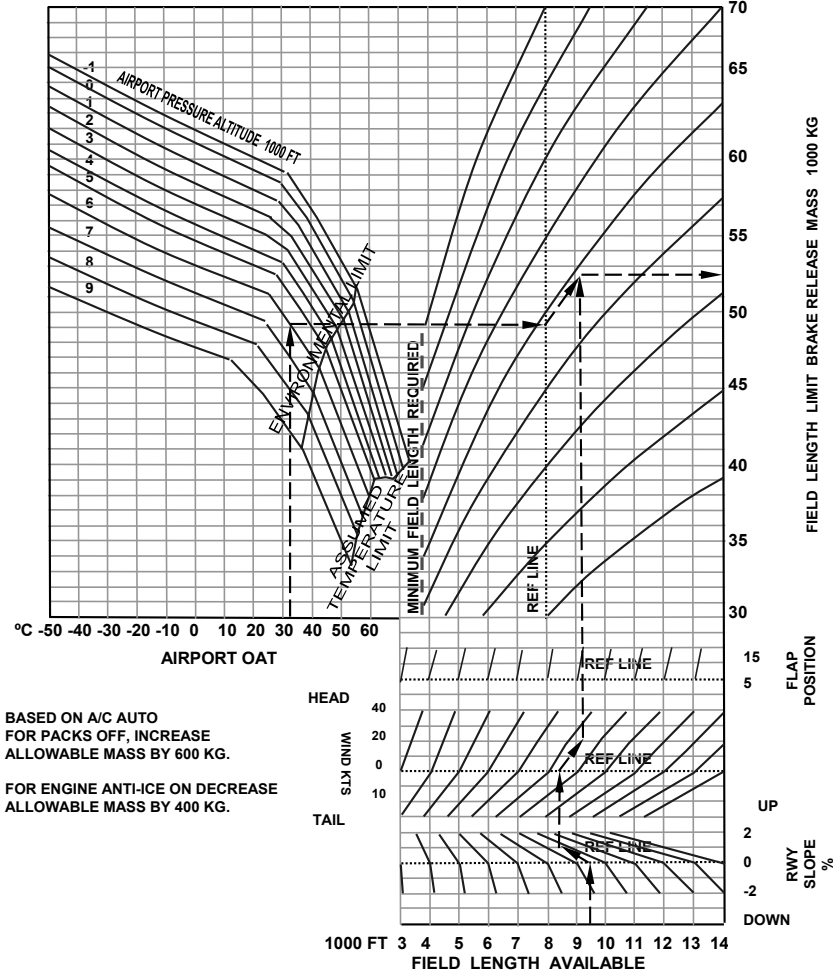

Figure 4-7 Take-off performance field limit, class A aeroplane

The last two factors, tyre speed and brake energy limitations are wholly operational and are not further discussed.

For a quick determination of an aeroplane take-off mass (performance class A aeroplane) a chart could be used. In this graph no clearway or stopway is taken into account. This means that in this

special case the field length is the take-off run (TORA) which equals the accelerated-stop distance (ASDA) and also equals the take-off distance (TODA). This gives more strict conditions and restricts more the aeroplane take-off mass but substantially simplifies the determination of the take-off mass (Figure 4-7).

Most of the airline companies have computerised programs which allow the calculation of the exact parameters by the dispatcher for particular airport conditions, and also for the pilot to recalculate when in full possession of the weather situation shortly before landing. Figure 4-9 gives an example of printed output for Poprad – Tatry airport from the STAS programme.

In the majority of cases, the aeroplane landing distance is smaller than the take-off distance. The final phase of landing begins at an altitude of 50 ft and ends with the full stop of the aeroplane. In practice, the aeroplane often vacates the runway, e.g. through a high-speed exit taxiway, rather than coming to a full stop, but the regulation distances are based on the former case.

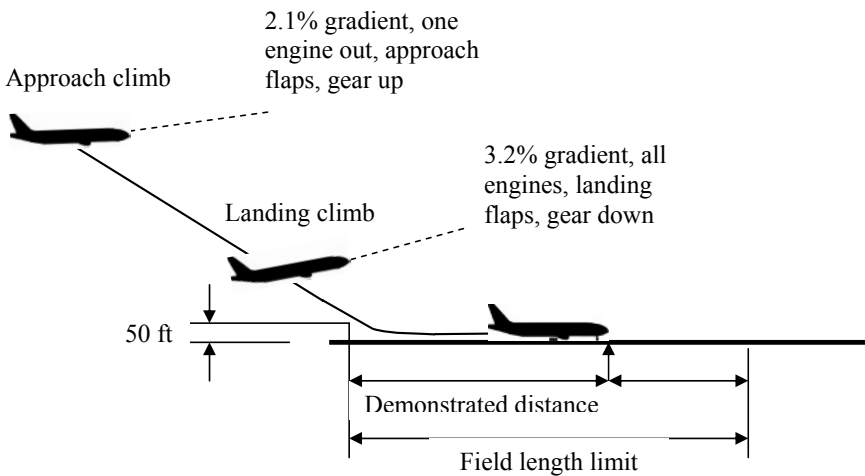

Figure 4-8 Landing performance requirements

The necessary runway length for landing should be greater than the actual minimum landing distance demonstrated by the manufacturer, so that day to day variations in pilot behaviour and effects of meteorological conditions may be taken into account. Regulations vary considerably with respect to the margins required over the determined landing distance, depending on the country and the state of the runway. According to the JAR/FAR requirements for a dry runway the mandatory distance is 167% of the demonstrated stopping distance.

Figure 4-9 – notes:

- 1 Maximum theoretical take-off mass with respect to Outside Air Temperature (OAT) x 100 kg, e.g. 617 = 61 700 kg.
- 2 Obstacle in climb sector limited MTOW (calm)
- 3 $V_R - 130$ kts
- 4 $V_1 - 130$ kts
- 5 $V_2 - 134$ kts
- 6 Other limitations codes

For a wet runway there are additional safety factors; the distance required is 115% of the dry runway distance from height 50 feet above the runway, no reverse thrust, maximum manual braking. The safety factor for Class A turboprop and all Class B aeroplanes is smaller: in their case, the demonstrated landing distance required is 143% for a dry runway (Figure 4-8).

Most regulations for the determination of landing performance now require the demonstration to be made on a standard wet runway with an appropriate flying technique for the conditions. An additional safety factor is often applied for low visibility landings, which can result in the landing distance being greater than the take-off distance required, particularly for modern twin-engined aircraft.

The decision as to whether the runway is to be extended or only a stopway and a clearway are to be provided beyond the original runway ends depends, among other things, on the characteristics of the terrain beyond the runway end and on the occurrence of possible obstacles.

In line with Annex 6, Part I, Operation of aircraft, Attachment C, 'Aeroplane performance operating limitations', and also with JAR-OPS 1.495, there are specified take-off obstacle clearance limitations (compare also with Annex 14, Volume I, Chapter 4 – 'Obstacle restriction and removal'). The net take-off flight path must clear all obstacles vertically by 35 ft or laterally by at least 90 m plus 0.125 D, where D is the horizontal distance the airplane has travelled from the end of the take-off distance available on both sides of extended RWY centreline. The sector widens with distance until becoming parallel after a specific distance.

If the flight path does not include track changes of more than 15° the maximum sector width is 300 m on each side from the centreline under VMC by day or when using navigation aids such that the pilot can maintain the aeroplane on the track, and 600 m for flights under all other conditions.

Where the flight path includes track changes of more than 15° the maximum sector width is 600 m on each side from the centreline under VMC by day or when using navigation aids such that pilot can maintain the aeroplane on the track, and 900 m for flights under all other conditions (Figure 4-10).

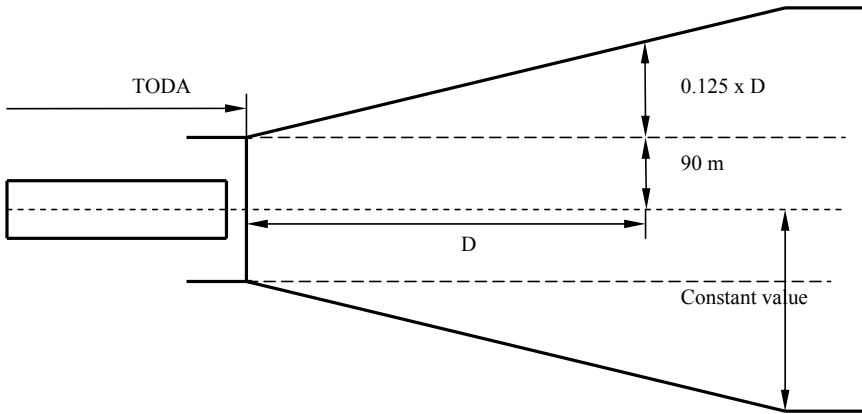

Figure 4-10 *Take-off climb obstacle clearance*

For aeroplanes with a wingspan less than 60 m (i.e. for most of commercial transport aeroplanes) the initial width of the sector is limited to 60 m + half of the wingspan.

Besides the field and structural limits a take-off also involves climb limits. If an engine fails after V_1 , the reduction of thrust may cause some obstacle clearance in the take-off sector to become critical.

The net take-off climb path begins at the screen height of 35 ft and ends at a minimum of 1500 ft above the aerodrome level. For every segment the gross gradient must be calculated first, assuming that the critical engine failed at V_1 . Then the net gradient is the gross gradient reduced by:

- 0.8% for 2 engined aircraft
- 0.9% for 3 engined aircraft
- 1.0% for 4 engined aircraft.

The net take-off path is used for calculation of the obstacle limited mass of the aeroplane. Minimum gradient requirements are specified for every climb segment. Each of these will determine an aeroplane mass for the altitude and outside air temperature. The lowest mass will determine the MTOM. All obstacles in the take-off climb sector must be cleared by at least 35 ft

(Figure 4-11). Any part of the net take-off flight path in which the aeroplane is banked by more than 15° must clear all obstacles by a vertical distance of at least 50ft.

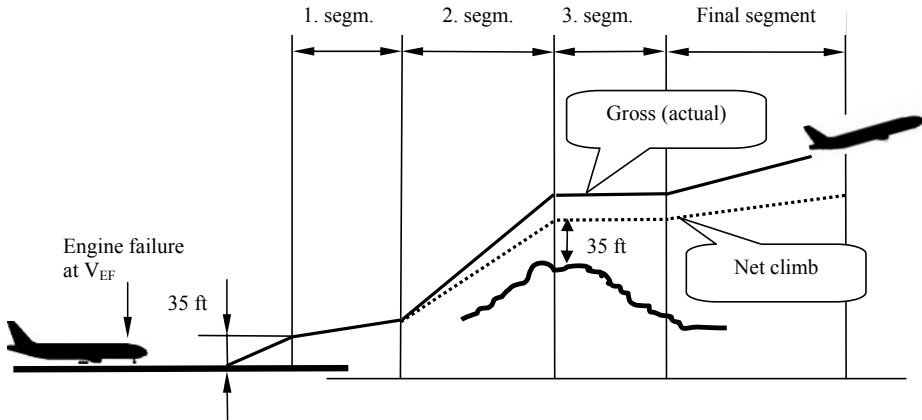

Figure 4-11 Take-off performance requirements

Notes:

- First segment** *From 35 ft to gear-up:* take-off (TO) slats and flaps, TOGA (take-off and go-around thrust), V_2 speed from 35 to gear-up.
- Second segment** *From gear-up to level-off flap retraction:* TO slats and flaps, TOGA thrust, V_2 speed to minimum 400 ft or minimum acceleration height given by the aircraft operator.
- Third segment** *Level flight, flap retraction:* Slats/flaps retracted TOGA (TOGA is certified for use for a maximum of 10 minutes, in case of an engine failure at take-off, and for a maximum of a 5 minutes with all engines operating. As a result, the enroute configuration (at the end of the third segment) must be achieved within a maximum of 10 minutes after take-off, thus enabling the determination of a maximum acceleration height. Acceleration from V_2 to Final segment speed, or VZF (VZF = minimum speed with flaps up, or 'Green dot' speed in Airbus).
- Final segment** *Final climb segment:* Clear configuration, MCT (maximum continuous thrust), final segment speed (VZF or 'Green dot' speed).

If there are obstacles to be considered in the take-off path, the flap setting that results in the shortest take-off distance does not always result in the maximum possible take-off mass. The

higher flap setting will result in short take-off distance, but because of increased drag the climb gradient after take-off may be not sufficient to clear the obstacles (Figure 4-12).

Figure 4-12 Flaps setting for the obstacle clearance

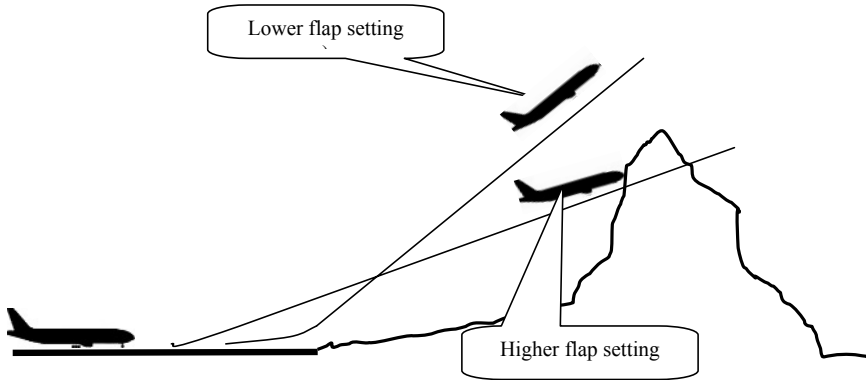

4.3 DECLARED DISTANCES

In order that the pilots and flight operators may be informed about the lengths of runway, clearway, stopway and runway strip, the airport operator has to publish the respective information in the air information publication.

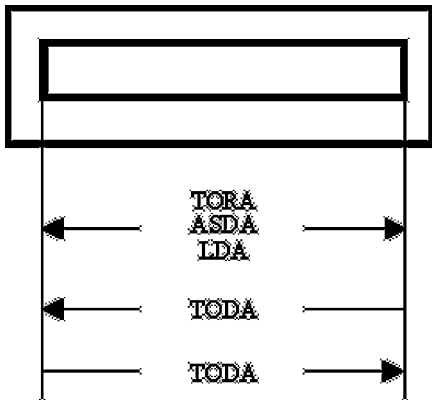

Figure 4-13a Declared distances

The information is published in a standardised form, and the declared distances determined for each runway direction include:

- TORA (take-off run available)
- TODA (take-off distance available)
- ASDA (accelerate stop distance available)
- LDA (landing distance available).

The particular lengths shall not be determined only by the length of runway or other movement surfaces, but also by their actual condition and contingent obstacles in the take-off or approach areas.

Figure 4-13 a-c gives several examples of declared distances. In general, it may be stated that the take-off run and landing may be performed only on a full strength runway, while the remaining

part of the take-off may be completed over a runway strip or a clearway.

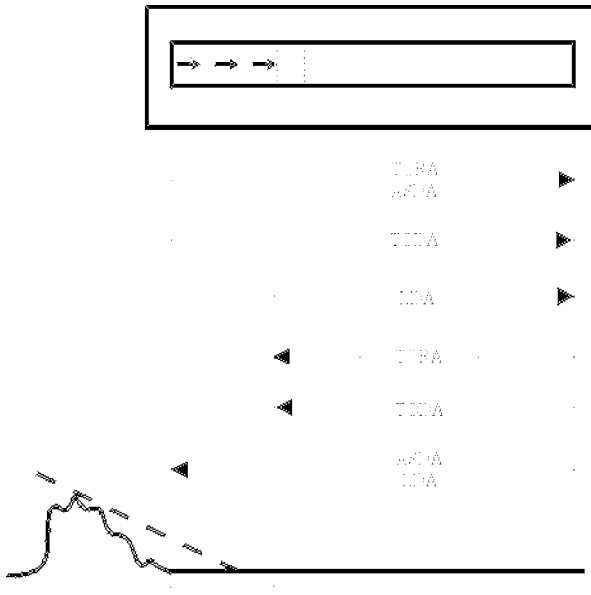

Figure 4-13b Declared distances with a displaced threshold

In many cases the runway will be full strength for its whole length with thresholds located at the runway ends, runway strips with specified dimensions shall extend beyond the end as well as along each side of the runway. In that case the declared distances will be the same in both directions, see Figure 4-13a.

Alternatively, the runway may have the landing threshold shifted, usually due to obstacles in the approach area. However, the portion of the full strength runway before the displaced threshold may be used for take-off, see Figure 4-13b.

Figure 4-13c illustrates a runway where the threshold was displaced due to a runway section in maintenance (left). Beyond the end of the runway a stopway was established (right). It is not possible to extend the runway in that direction because an obstacle occurs in the take-off area. The stopway is full strength and is surrounded by runway strips.

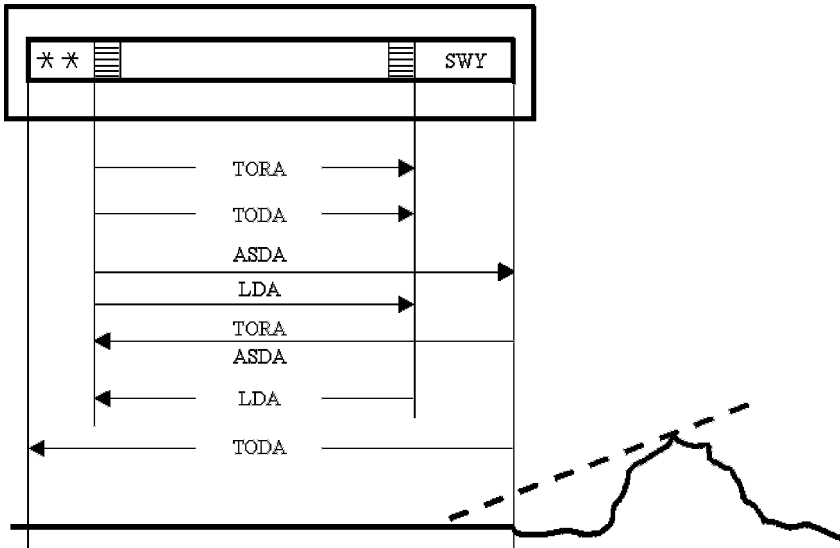

Figure 4-13c Declared distances with displaced threshold and stopway

4.4 RUNWAY WIDTH

4.4.1 Runway Width Requirements

As already stated in the above section 4.1 on the Aerodrome Reference Code, the width of a runway is one of the elements that is affected by several geometrical characteristics of aeroplanes:

- the distance between the outside edges of the main gear wheels
- the distance between wing mounted engines and the longitudinal axis of an aeroplane
- the wing span.

However, the required runway width is also affected by the operational elements:

- the approach speed of the aeroplane
- the prevailing meteorological conditions.

Lack of sufficient width will cause constraints on the operations. The minimum runway width is therefore specified in Annex 14 by interrelating both of the code elements, see Table 4-5.

Under normal conditions, the width of a runway should ensure that an aeroplane does not run off from

the side of the runway during the take-off or landing, even after a critical engine failure causing the aircraft to yaw towards the failed engine.

Table 4-5 Minimum runway width

Code number	Code letter					
	A	B	C	D	E	F
1 ^X	18 m	18 m	23 m	-	-	-
2 ^X	23 m	23 m	30 m	-	-	-
3	30 m	30 m	30 m	45 m	-	-
4	-	-	45 m	45 m	45 m	60 m

^X/ The width of a precision approach runway should be not less than 30 m where the code number is 1 or 2.

Source: ICAO Annex 14, Aerodromes, Volume I, Aerodrome Design and Operation

Deviation from the runway axis during take-off and landing occurs in particular due to a lack of ability in tracking the centreline. With impaired visibility, adverse cross – wind conditions, or poor braking action, the probability of an off-centre touch-down or a slide sideways from the runway axis during take-off increases. Therefore a wider runway is specified for precision approach runways where the code number is 1 and 2. Under some regulations, it is possible for the first part of the takeoff roll to be on a reduced width runway (referred to as a starter strip).

4.4.2 Runway Shoulders

According to Annex 14, Volume I, Chapter 3, a width of 45 m is sufficient for runways where the code letter is E, that width of pavement conforming with the undercarriage gauge of the largest aeroplanes. In the event that an aeroplane touches down off the centreline of a runway, even though the undercarriage is on a full strength pavement, the wing mounted engines overlap its edge. Thus they could take in loose material, such as small stones, with a possibility of consequent Foreign Object Damage (FOD) to the engine. Therefore runway shoulders should be provided for a runway where the code letter is D and E so that the over-all width of the runway and its shoulders is not less than 60 m. If the code letter is F, the width of the runway itself must be 60 m.

The shoulders may be turf over stabilised earth, but are usually designed as light asphalt pavements with a load bearing capacity that will support the loads of the ground equipment and reduce the probability of damage to an aircraft veering off the runway. Runway edge lights are located in the

runway shoulders. The winter maintenance of the edges of a runway is then considerably simpler than where the lights are installed in the grass strip.

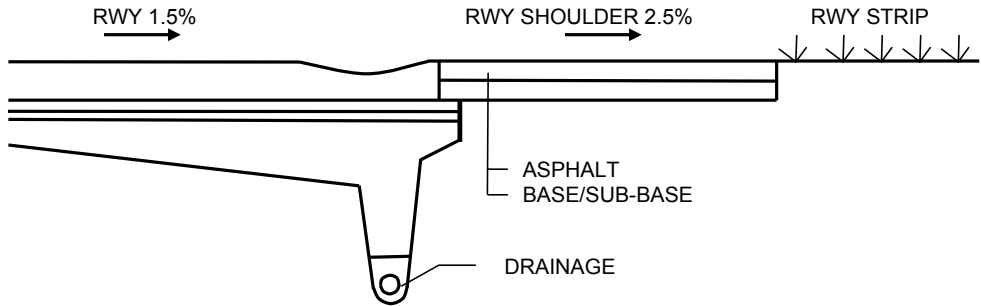

Figure 4-14 Runway with runway shoulder

(Source: J. Čihař, *Letiště a jejich zařízení I.*, Alfa Bratislava 1973)

A light asphalt shoulder is not designed for the very rare event of an aeroplane running off the runway, so when it happens it damages the pavement. The repair of an asphalt pavement is quite demanding. Nevertheless, its load bearing capacity should prevent the wheels from being bogged down, which may cause serious damage to the aeroplane. At the same time, a shoulder provides a gradual change of the load bearing capacity between a runway and its associated strip. If a runway is made of cement concrete and a shoulder is made of asphalt, the passage between the runway edge and the shoulder is visually distinctive and clear enough. If both the runway and the shoulder have asphalt surfaces, the edge of the runway should be indicated by a runway side stripe marking. The shoulder should be vertically flush with the runway edge. An example of a runway design with a shoulder is given in the Figure 4-14.

4.4.3 Runway Turn Pads

At the end of a runway of a code letter D, E or F a turn pad must be provided if the runway end is not served by a taxiway or a taxiway turnaround to enable a 180 degree turn of aeroplanes (Figure 4-15). It is useful to have such turn pads also along the runway to reduce taxiing time for aeroplanes which do not require full runway length. The shape, location and placement of the turn pad are not obligatory but it is an advantage to locate the turn pad on the left side of the runway, since the standard pilot-in-command position is on the left seat. There are also no binding requirements with respect to the turn pads dimensions except that the intersection angle of the pad with the runway should not exceed 30 degrees and the aeroplane nose wheel steering angle to be used in the design of the runway turn pad should not exceed 45 degrees.



Figure 4-15 Turn pad at the runway end

(Photo: A. Kazda)

Depending on the code letter of the runway and the aeroplane wheel base dimensions, minimum margins of safety between 1.5 m to 4.5 m should be provided between any wheel of the aeroplane landing gear and the edge of the turn pad when the cockpit of the aeroplane is over the turn pad marking. The requirements on the turn pad slopes, bearing strength of the pavement and the pavement surface are similar to those of the adjacent runway.

4.5 RUNWAY SLOPES

4.5.1 Transverse Slopes

Annex 14 recommends that runways be constructed with a roof-like cambered transverse slope, the slope providing quick rainwater drainage particularly in heavy rain and side winds. In spite of that, there are cases when a designer is forced to design a one-sided transverse slope of a runway to reduce costs of earthwork (Figure 4-16), or to avoid too thick a runway construction when a roof-like profile is selected, or to reduce cost by providing a drainage channel on only one side of the

runway. In order that drainage may be ensured, the transverse slope of a runway should be at least 1 per cent but should not exceed 2 per cent, depending on the code letter. The transverse slopes should normally facilitate drainage and minimise the layer of water accumulated on the runway. In some cases the drainage is improved by a transverse grooving of the pavement which, however, in no case may replace the prescribed slopes.

4.5.2 Longitudinal Slopes

Few runways are level throughout their length in the longitudinal direction. Often there are several slope changes in its length. A completely horizontal runway could be constructed, but this would



Figure 4-16 One-sided transverse runway slope and changes of longitudinal slopes are clearly visible (Photo: A. Kazda)

generally require considerable earthwork. On the other hand, there is a limitation on the allowable longitudinal slope due to the performance characteristics of particular types of aeroplanes and the requirements of the operation. The Annex 14 standard therefore limits the so called average slope of a runway, which is calculated by dividing the difference between the highest and the lowest points of a runway by its all-over length; and also limits the maximum slope of any arbitrary portion of a runway, the profiles usually being controlled in segments of 50 to 100 m.

For example, the longitudinal slope of the precision approach runways where the code number is 3

and 4 is limited to 0.8 per cent in the first and last quarter. The strict limitation of the slope is determined either in order to facilitate the final phase of flare in impaired meteorological conditions or by technical parameters of the equipment for a precision instrument approach, particularly the radio–altimeter. The longitudinal slope of non-precision runways of civil airports is limited to 1-2 per cent, depending on the code number.

In special cases, a longitudinal slope up to 8 per cent is permitted for one-way runways in airfields for agricultural activities, for special airfields for mountain rescue services, or, indeed, for commercial service in mountainous areas.

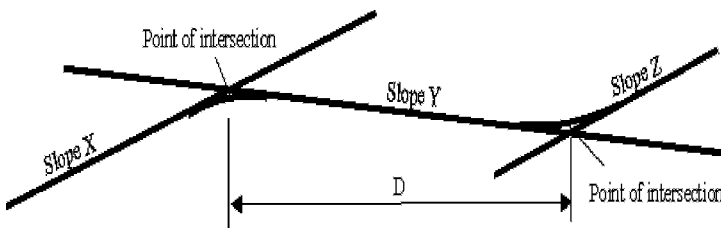

Figure 4-17 Profile of centre line of runway

(Source: ICAO Annex 14, Aerodromes, Volume I, Aerodrome Design and Operation)

Longitudinal slope changes are also limited. The objective of limiting local roughness is to confine dynamic load of the undercarriage system of an aeroplane when it moves in a high speed on the runway, and to secure permanent and safe contact of the tyres with the surface of the runway. Longer slope change limitations are to ensure the pilot has an adequate view of the runway. A change from one slope to another should be achieved by a minimum radius curvature of 7 500 m - 30 000 m, depending on the code number of the runway. Similarly, the distance between the apexes of two neighbouring curvatures shall be limited. The distance should not be less than the sum of the absolute numerical values of the difference of longitudinal slopes multiplied by a factor, depending on the magnitude of the curvature, in turn depending on the code number of the runway, or 45 m, whichever is the greater (see Figure 4-17).

$$D = k [|x - y| + |y - z|]$$

where:

- D minimum distance between point of intersection of slope changes in metres
- k minimum radius of curvature (between 7 500 – 30 000 with respect to the RWY code number)

x,y,z longitudinal slopes per mile

The longitudinal slope changes are furthermore limited by the requirement of mutual visibility between two points at a height of 1.5 to 3 m (according to the code number of a runway) and at a distance which is equal to at least one half of the runway length.

5

RUNWAY STRIPS AND OTHER AREAS

Tony Kazda and Bob Caves

5.1 RUNWAY STRIPS

Each runway should be surrounded by a runway strip. The runway strip is intended to ensure the safety of an aeroplane and its occupants in the event of an aeroplane:

- undershooting, overrunning or veering-off the runway during landing or takeoff
- deviating from the runway centreline during a missed approach.

The physical characteristics and other requirements for runway strips are derived from the need to allow for these events.

The required width of a runway strip depends on the degree of approach guidance to the runway and also on the runway reference code number. The width of a non-instrument runway strip should extend for 30 to 75 m on each side of the centre line of the runway. A strip of an instrument and a precision approach runway should extend for 75 to 150 m. The runway strip should extend past the runway end by 30 to 60 m. No equipment or constructions which may create an obstacle or endanger aeroplanes should be situated on a runway strip. The only exception is radio-navigation, visual and other equipment which should be installed on the runway strip to support the operation of aircraft, for example the Instrument Landing System (ILS) glide path antenna, Precision Approach Radar (PAR), Runway Visual Range (RVR) equipment, and the like. If possible, the equipment should be mounted on frangible fittings and marked with an obstacle

marking.

In the majority of cases the surface of a runway strip should be grass or soil. It is intended that, in the event of an aeroplane running off the runway, the undercarriage of the aeroplane should gradually sink into the runway strip, thus providing effective deceleration of the aeroplane. The aeroplane's structure should not suffer serious damage.

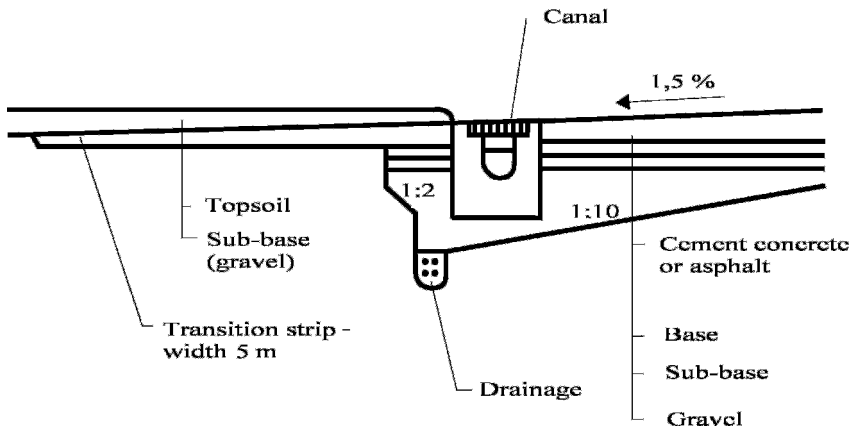

Figure 5-1 *Transition strip – gravel and topsoil*

(Source: J. Čihař, *Letiště a jejich zařízení I.*, Alfa Bratislava 1973)

It is probable that in the event of an aeroplane veering-off the runway, the aeroplane will not need the whole width of the runway strip for protection. Therefore the surface of a runway strip need not have the same quality over all its area. Depending on the category of approach guidance of a runway and its reference code number, the surface of a runway strip should be able to cater for the event of an aeroplane veering-off to a distance of 30 to 75 m from the centre line of the runway with little damage to the aeroplane. This part should have a bearing strength of approximately CBR 20, which requires the top 20 cm of soil be compacted as well as complying with the specified slopes and quality of the surface. Also, over the whole portion of a runway strip to the specified distance from the runway, there must not be any solid vertical constructions even under the surface of the runway strip to a depth of at least 30 cm which a sinking wheel of the aeroplane might impact. Such obstacles may, for example, be foundations of lighting installations and airside signs, drainage gutter inlets, or the edges of taxiways within the runway strips. At least the upper 30 cm of such a construction should be chamfered. Other equipment which need not be installed at the surface level should be sunk to a depth of at least 30 cm.

The strength of a runway strip will depend on geological conditions and the height of the water table. It may be necessary to put in drains to reclaim the land. In exceptional cases, a runway strip should be strengthened in the same way as a runway with a grass surface at general aviation airports. In addition, it is necessary to guarantee a gradual rate of change in the reduction of strength from the edge of a runway or runway shoulders to facilitate the smooth deceleration. If the edge of a runway directly abuts a grass strip, it is possible to design wedges of compacted gravel or fine gravel upon which a layer of topsoil is spread for a distance of approximately 5 m from the edge of the runway see Figure 5-1. There are also new solutions for increasing the runway strip strength based on a mixture of natural constituents and inert polymer fibres which guarantee three-dimensional strength and stability of the rootzone. The polymer fibres reinforce and protect the natural turf. A gradual change of the strength is provided also by runway shoulders if they are constructed, as described in Chapter 4.



Figure 5-2 *Large constructions are sometimes necessary to guarantee runway strip dimensions – Vienna Airport (Photo: A. Kazda)*

There are firm recommendations for the control of temporary obstacles in the strip. The extent to which hazards may be created by work in progress should be controlled by the relevant authority.

It should take account of the type of aircraft, the runway width, the meteorological conditions and the possibility of using other runways. If work is allowed, the resulting hazards must be promulgated by NOTAM. In Zone 1, within 21 m of the runway edge, work may only take place on one side of the runway. The area under work must be of limited size, and the clearance of engines and propellers must not be compromised. No plant or machinery should operate in this area when aircraft are using the runway. If an aircraft is disabled in this zone, the runway must be closed. Less severe restrictions apply in Zone 2, which extends to the edge of the graded portion of the strip.

If an airport is used by aeroplanes with jet engines, the portion of a runway strip within a distance of at least 30 m before a threshold should be sealed over the width of the runway. This prevents erosion by the action of exhaust gases and exposure of an edge of the runway pavement. The construction of a light pavement for such a purpose may be similar to that of runway shoulders.

As with other airside dimensions, those specified for a runway strip should be understood as the minimum requirements, and in some cases it may be necessary to widen a runway strip. On the other hand, there may be cases where a smaller width of a runway strip is sufficient, for example, for the portion of a runway intended only for take-off, the so called 'starter-strip'.

5.2 CLEARWAYS

A clearway may be provided to extend the takeoff distance available (TODA) beyond the end of the hard surface which defines the declarable length of the available takeoff run (TORA). It implies that the ground in the clearway should not project above a plane having an upward slope of 1.25 per cent between the end of the hard runway and the end of the clearway. A clearway is feasible because the last part of a takeoff takes place in flight rather than on the ground. It is usual to also provide a stopway, often rather shorter than the clearway but not too short, since aircraft cannot normally use a very unbalanced takeoff. To the extent that the aircraft's performance characteristics permit it, the clearway allows a pilot to choose a relatively low decision speed, after which it would be advisable to fly rather than stop if an emergency occurred. Then a relatively shorter accelerate-stop distance is needed and hence a lower cost of prepared surface. A clearway should extend to a width of at least 75 m on each side of the centre line of the runway and its length should not exceed half the length of the runway length available for take-off. It is subject to the same possible limitation as a more normal provision of TODA, that the imaginary takeoff surface which starts at the end of the clearway must not be broken by obstructions.

5.3 RUNWAY END SAFETY AREAS¹

Operational experience and statistical data of accidents where the aircraft has landed short or overshoot a runway have shown that the 30 m to 60 m portion of the runway strip which is located off the ends of runways does not provide sufficient protection for aircraft in these circumstances. Some of the most serious overrun accidents occur in the event of an aeroplane running off the runway end when the decision to abort a takeoff has been taken after the speed has already exceeded the V_1 speed, after which takeoff should normally be continued. Such cases occur mostly when a pilot judges that, even at that speed, the takeoff cannot be continued because of the nature of an engine failure, or serious vibrations, or when a failure occurs after the normal lift-off speed (V_{LOF}) which makes it impossible to fly, such as an incorrectly adjusted stabiliser trim setting. In that case the aeroplane has considerably greater speed than for example in the event of an aeroplane running off beyond the runway end after landing under poor braking conditions, or when a pilot touches down well beyond the touchdown zone, which is normally some 300 m from the threshold.

For those reasons, a runway end safety area (RESA) of at least 90 m should be provided at each end of a runway strip of a runway where the reference code number is 3 or 4 and the runway is an instrument one. The latest 4th edition of Annex 14 (July 2004) recommends that, where possible, 240 m of RESA should be provided for code 3 and 4 runways, making together with the runway strip a total of 300 m available to contain an overrun.

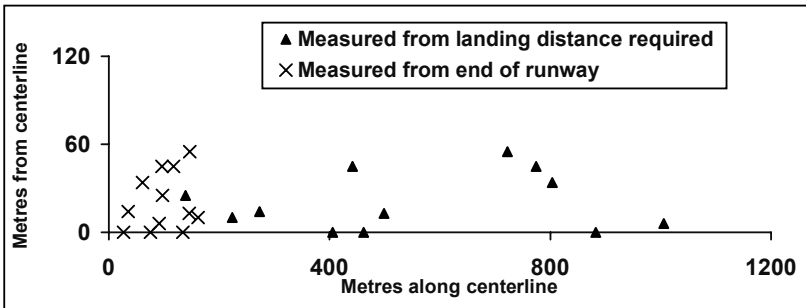

Figure 5-3a Wreckage location relative to runway end (landing)

Dimensions of runway end safety areas should be determined on the basis of statistical data on an occurrence of accidents beyond the runway end. The ICAO accident data base shows that about eighty per cent of all overrun and undershoot accidents would be contained within a runway end

¹ In FAA documents are referred to as Runway Safety Area

safety area extending 90 m beyond the end of the runway and double the width of the runway, surrounded by a normal runway strip. Ninety per cent of all such accidents would be contained within a runway end safety area 150 m wide and 300 m long. However, the data only give the actual distance that aircraft have overshoot the runway, regardless of the available length, the expected distance required for the take-off or landing, and the characteristics of the runway and overrun area. Figure 5-3a shows the difference between the ICAO data and the real extent of the excess distance used up compared with the nominal flight manual performance in a small sample of landing accidents.

A similar set of results is obtained for rejected take-off overruns, as in Figure 5-3b. These differences should be taken into account in the assessment of risk at airports, as it is clear that those airports where a large proportion of landings use the full runway length will be more likely to experience an overrun, other things being equal.

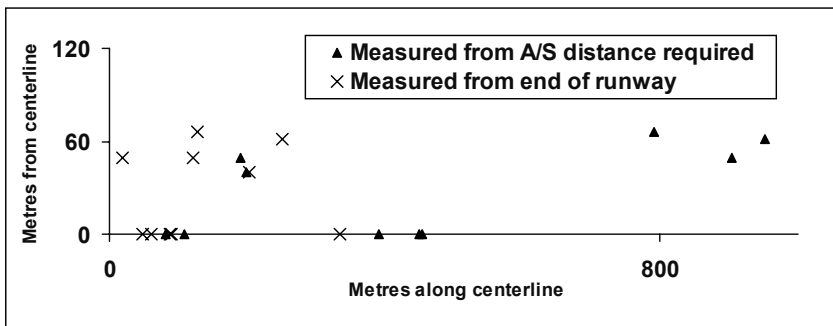

Figure 5-3b *Wreckage location relative to landing distance required*

(Source: Kirkland, I. and R. E. Caves, (1998), *Risk of overruns*, ACI Europe Airport Safety Symposium, Riga, September)

Further enlargement of a runway end safety area is practically impossible due to the fact that at the majority of airports, the localiser antenna of the ILS is located not further than 300 m beyond the end of the runway. In the event of an aeroplane running off into the runway end safety area, it should not sustain such damage as would have a serious consequence for the occupants, for example breach of fuel tanks, breakage of fuselage, or fracture of undercarriages. Therefore, in the runway end safety areas, there must not be any embankments or ditches for roads, railways or water courses. There are also limits to the positive and negative slopes which are allowed.

In some cases there is not enough space to provide a runway end safety area without reducing the declared runway length. Neither is it possible to use for civil purposes the type of equipment commonly used in the Air Forces for stopping aeroplanes that run off beyond the runway end. The

reasons are both the different procedures, particularly the legal position of the pilot-in-command, and the dimensions and mass of the commercial aircraft, for which it is technically difficult to provide equipment that would be able to stop them safely.

In some US airports, where it was not possible to build up runway end safety areas, arrestor beds are built from Engineered Material Arresting System (EMAS). EMAS is a 'soft ground arresting system' consisting of a crushable cellular cement material installed on the runway overrun to decelerate an aircraft in an emergency and provides capability to stop an aircraft before reaching an existing hazard (road, railroad, waterway, steep embankment, etc.).



Figure 5-4 *The Dassault Falcon 900 business jet successfully arrested by the ZODIAC-ESCO EMAS system at Greenville Downtown airport on 17 Jul 2006*
(Courtesy ESCO ZODIAC, photo: David J. Heald, C.M.)

When an aircraft is unable to stop on the runway, the aircraft rolls into the EMAS arrestor bed, and is decelerated by the loads applied to the aircraft landing gear as the aircraft wheels travel through the EMAS. As tyres crush the material, it provides a decelerative load, the drag load rather than friction slowing the aircraft down (Figure 5-4).

The depth of the EMAS gradually increases as the aircraft travels into the arrestor bed, providing increasing deceleration when required by heavier or faster aircraft. Aircraft over-run distance is determined by the aircraft size, mass, speed and bed configuration. The cellular cement blocks of the arrestor bed are produced in factory as pre-cast blocks and are then transported to the airport

for installation.

There are no problems for aircraft landing short onto the EMAS, because most of the weight is being taken by aerodynamic forces and the tyres will not break through the surface. It would, however, be a problem if the aircraft landed prior to the EMAS because it would then encounter the thick section first and probably shear off the landing gear. Therefore, the EMAS should be as far off the end of the runway as possible.

The EMAS bed matches up the width of the corresponding runway, plus 5 to 9m for the stepped sides, to facilitate the emergency vehicle access and passenger egress, depending on the maximum depth of bed material. EMAS includes a paved rigid ramp, usually 22.5 m long, in front of the arrestor bed.



Figure 5-5 *EMAS installation at Boston Logan Airport, courtesy ESCO ZODIAC Company*
(Photo: David J. Heald, C.M.)

FAA identifies EMAS as an equivalent to a 1,000-foot long runway end safety area and provides guidelines on comparing various runway safety area (RSA) improvement alternatives to the EMAS option. EMAS performance is varied by increasing the depth and the length of the bed, and variations of the bed material strength. The FAA specifies the design goal as 70 knots runway exit

speed, including the effects of deceleration on the paved portion of the EMAS in front of the arrestor bed.

Snow removal from the EMAS bed is necessary if snow obscures approach lights, or affects the ILS. If a large, asymmetrical snow accumulation occurs on one side of the bed, it may affect the ILS signal and the snow must be removed. For snow clearance a special snow blower tracked vehicle with very low surface pressure must be used to avoid EMAS damage.

The system is FAA approved and by January 2006 was installed at 18 USA runways including Boston Logan Airport (Figure 5-5) and two installations at New York JFK and La Guardia airports.

Other types of crushable arrestor beds have been installed in other countries, including at Manchester airport in the UK.

If safety is to be ensured, it is necessary to consider not only the runway strip and the runway end safety areas. Attention must be given also to the near surroundings of the airport, particularly under the approach path.

Here there should not be any elevated cement-concrete constructions, sharp embankments for the containment of sewage plants, canals, or transport links. For example, when a Boeing 737 made an emergency approach to the East Midlands Airport in Great Britain on 8.1.1989, the aeroplane impacted the embankment before the runway where the M-1 motorway runs through a cutting. The severe impact loads broke the fuselage and the aeroplane wreckage blocked the motorway. Forty-seven people died in the subsequent fire. If the motorway had been covered, the accident probably would not have claimed victims (Figure 5-6). There is a whole range of airports with similar dangerous obstacles which fall outside the direct responsibility of the airport and its designers. Yet this is the location of most remaining fatal accidents, largely because the on-airport protection and rescue facilities are so good.

It is also the area where third parties are likely to be killed or injured. Some countries therefore require that a public safety zone (PSZ) be established off the end of busy commercial runways with the purpose of limiting the allowable land uses. The UK has recently adopted a new form of PSZ based on research which shows the area of constant risk to be described by contours of similar shape to the noise contours. They have been approximated to thin triangles in the UK regulations, where new dwellings will not be permitted if the individual risk of death is greater than one in 100 000 per year.

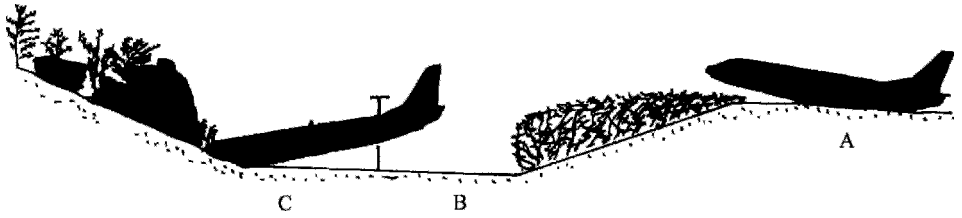

Figure 5-6 Phases of East-Midlands accident:

A/ The first touch before motorway

B/ Impact on the opposite bank

C/ Final position of the destroyed fuselage

6

TAXIWAYS

Tony Kazda and Bob Caves

6.1 TAXIWAY SYSTEM DESIGN

It is often difficult to design an optimum system of taxiways. The taxiway system may have a decisive influence on the capacity of the runway system, and thereby also the overall capacity of the aerodrome. Yet the surface area of taxiways may be greater than the area of runways. For example, in the case of the Osaka's Kansai International Airport, opened in 1994, the taxiways have an overall length of 11.3 km, and the runway has a length of 3 500 m. Considering that the load bearing strength of a taxiway should be equal to or greater than the load bearing strength of a runway, the construction of taxiways represents an important item in the total investment costs. Therefore it is necessary to optimise the taxiway system layout to provide efficient taxiing without undue expense.

The taxiways should permit safe, fluent and expeditious movement of aircraft. They should provide the shortest and most expeditious connection of the runway with the apron and other areas in the airport. This minimises time and also the fuel consumption of the aeroplanes, which has a positive effect upon the environment. The safety of aeroplanes is enhanced if the taxiways are designed to allow one-way operation, and if crossing other taxiways, and particularly runways, is minimised. The FAA has issued guidance for the provision of end-around taxiways in order to minimise the need to cross runways. These taxiways are to be provided with a screen to hide

aircraft on the taxiway from pilots lined up for takeoff so that they concentrate only on observing aircraft which may be actually on the runway (Airports International, April 2006).

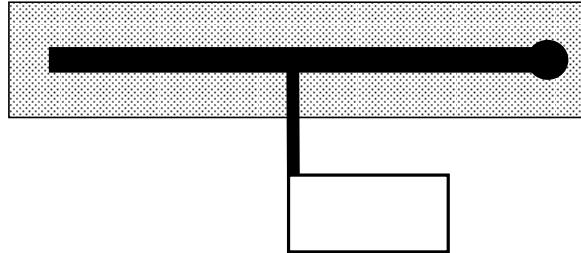

Figure 6-1 *Runway and apron connected with short right angle taxiway*

In those aerodromes where the number of aircraft movements during the peak hour traffic is relatively small, it is usually sufficient to provide only a short taxiway at right angles to the runway to connect it to the apron. To cope with larger aeroplanes, it is then usually necessary to provide additional pavement at the ends of the runway to allow the aircraft to turn round. The runway occupancy time is then considerable, Figure 6-1.

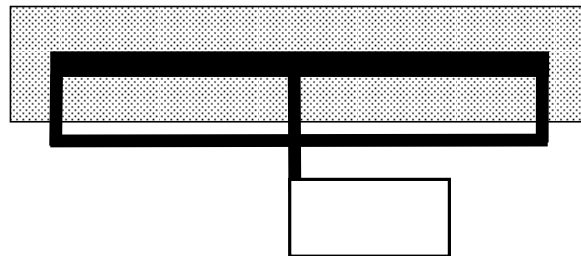

Figure 6-2 *System of a parallel taxiway with right angle connections*

If the number of movements during the peak hour traffic exceeds about 12, consideration may have to be given to construction of a taxiway parallel to the runway, and right angle connecting taxiways at the ends of the runway. In addition, in the event of a longer runway, several right angle connecting taxiways may be constructed, usually at one third or quarter of the runway length.

The system of a parallel taxiway with right angle connections may be sufficient for up to 25 movements during the peak hour, Figure 6-2.

6.2 HIGH-SPEED EXIT TAXIWAYS

To improve the capacity further, it is necessary to construct one or more rapid exit (high-speed exit) taxiways, usually from the preferred direction of the main runway, whose parameters and location need to correspond to the type of operation on the given runway (Figure 6-3).

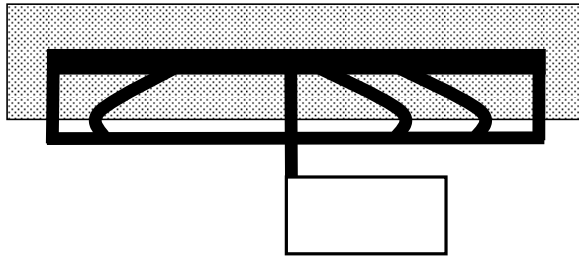

Figure 6-3 System of a parallel taxiway with right angle connections and high-speed exit taxiway

The parameters of high-speed exit taxiways, their dimensions and geometrical characteristics are standardised in the Annex 14 and in the Aerodrome Design Manual, Part 2. The purpose of the standardisation is to allow the pilot to anticipate the conditions at a less familiar aerodrome in order to avoid prolonging the time of occupation of the runway occupancy time by failing to make the best use of the turn-off.

Table 6-1 Categories of airplanes according to their speed overhead the threshold

Category	Airplane speed overhead the threshold
A	less than 169 km/h (91 KT) IAS
B	169 km/h (91 KT) or more but less than 224 km/h (121 KT) IAS
C	224 km/h (121 KT) or more but less than 261 km/h (141 KT) IAS
D	261 km/h (141 KT) or more but less than 307 km/h (166 KT) IAS
E	307 km/h (166 KT) or more but less than 391 km/h (211 KT) IAS

Source: ICAO Doc 8168/I, Part III, Chapter 1

It is also more likely that they will be used effectively if distance markers are set up 300, 200 and 100 metres before the throat. The parameters of a high-speed exit taxiway, particularly the radius of the turn-off curve, should permit turning off the runway at a speed of up to 93 km.h⁻¹ if the runway code number is 3 or 4; and 65 km.h⁻¹ if the runway code number is 1 or 2, even if the surface of the runway is wet. The correct location of the beginning of the high-speed exit taxiway

from the landing threshold of the runway is important in obtaining optimum use of the facility. It depends on:

- speed of the aeroplane crossing the threshold of the runway
- deceleration of the aeroplane after its touch-down
- initial speed of turn-off.

In line with Doc 8168/I, Part III, Chapter 1, the aeroplanes have been divided into five categories based on 1.3 times the stall speed in the landing configuration at maximum certificated landing mass overhead the threshold of the runway, as shown in Table 6-1.

For the purpose of high-speed exit taxiway design, the aeroplanes are assumed to cross the threshold at a speed that is equal to $1.3 V_S$, where V_S is the stalling speed of the aeroplane in the landing configuration with an average gross landing mass (85 per cent of the maximum landing mass). Table 6-2 gives examples of ranking of the aeroplanes into groups on the basis of their threshold speed.

Table 6-2 Examples of ranking of the aeroplanes into categories on the basis of their threshold speed

A	B	C	D	E
Convair 240	Convair 600	B-737	B-747	Concorde
Saab 340	DC-6	B-707	DC-10	
DC-3	Fokker F 27	B-727	L-1011	
DHC-7	ATR – 72, 42	A-380 ¹	A-380 ¹	

¹/ Depends on the aircraft mass

The final design of high-speed exit taxiways will depend also on other factors, such as runway slope, aerodrome elevation and reference temperature.

It must be emphasised that the number of high-speed exit taxiways depends on the types and number of aeroplanes intended to utilise the runway during the peak period. The location of the start of a high-speed exit taxiway may be derived by assuming a constant retardation 'a'. The following shall apply for such a movement:

$$\frac{dv}{dt} = \frac{d^2s}{dt^2} = a; \quad v(t) = \int a \cdot dt = a \cdot t + C_1$$

$$s(t) = \int (at + C_1).dt = \frac{1}{2}.at^2 + C_1.t + C_2$$

With the beginning of path $s=0$ to the point with speed $v=0$ in the moment of time $t=0$ (see Figure 6-5) then $C_1 = C_2 = 0$ and the following expression is generally valid:

$$v(t) = at; \quad s(t) = \frac{1}{2}.at^2$$

if the direction to the right of the full-stop point (i.e. $s(0) = 0$) is considered to be positive and at the same time the 'acceleration' 'a' negative. This is illustrated by the Figure 6-4 the meaning of which is expressed by the following:

$$s_1 = \frac{1}{2}.at_1^2; \quad v_1 = at_1; \quad t_1 = \frac{v_1}{a}$$

After substitution in s_1 we will get:

$$s_1 = \frac{1}{2}.(at_1)t_1 = \frac{1}{2}.v_1.t_1 = \frac{1}{2}.\frac{v_1^2}{a}$$

As an analogy we can derive:

$$s_2 = \frac{1}{2}.\frac{v_2^2}{a}$$

The final expression is:

$$D = s_1 - s_2 = \frac{v_1^2 - v_2^2}{2.a}$$

where is:

- A mean deceleration of the aeroplane after landing [$m.s^{-2}$]
- S_1 total braking distance from the touch down (1) to the full-stop point (0) [m]
- $S(t)$ distance at time (t) when the beginning of the path is in (0) [m]
- $v(t)$ speed at time (t) [$m.s^{-1}$]
- v_1 speed over a threshold of the runway [$m.s^{-1}$]
- v_2 design speed of turn-off at location (2) [$m.s^{-1}$]
- T time [s]
- t_1 time required to stop in distance s_1 from the approach speed v_1
- t_2 time required to stop in distance s_2 from the speed v_2
- D high-speed exit taxiway distance from a threshold

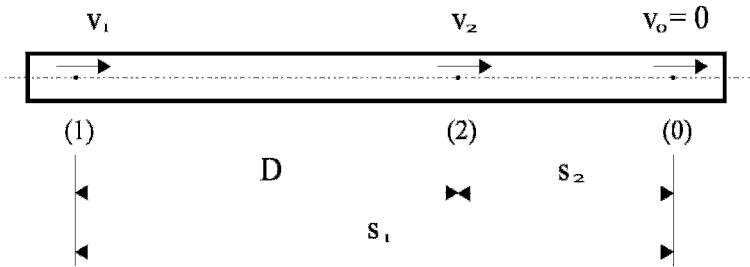

Figure 6-4 *High-speed exit taxiway distance from a threshold*

The deceleration should not exceed 1.5 m.s^{-2} in order to avoid passenger discomfort. The intersection angle of a high-speed exit taxiway with the runway should not be greater than 45° or less than 25° and preferably should be 30° . It is common practice for the entry to take the form of a spiral, so that the lateral deceleration requirement is not too severe while the aircraft is moving at high speed. This makes it more likely that the exit will be used when the runway friction is reduced. A high-speed exit taxiway should include a sufficient straight portion after the turn-off curve so that the pilot can stop the aeroplane before the next taxiway intersection. Figure 6-5 illustrates an example of a high-speed exit taxiway.

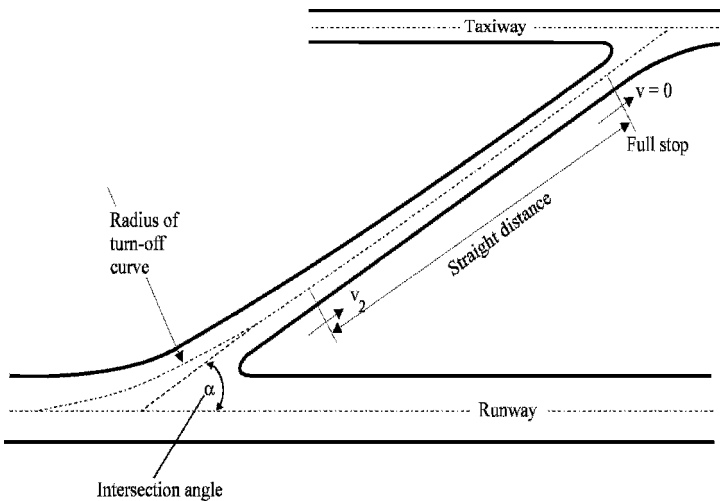

Figure 6-5 *Characteristics of high-speed exit taxiway*

It is often necessary, where the traffic volume is high, to establish two parallel taxiways to facilitate one way flow, together with holding bays located near the ends of the runway. Holding

bays allow the flight controller to bypass aeroplanes and thus optimise the sequence of take-offs depending on the aircraft's speeds, weights and departure routings.

6.3 TAXIWAY SEPARATIONS

The minimum safe separation distance between the centre line of a taxiway and the centre line of a runway is defined as a standard in Annex 14. The actual distance depends on the code number of the runway and the category of its approach aids, and it is such that the wingtip of a taxiing aircraft will not encroach into the runway strip. With the introduction of a Code F in Annex 14, the distance might have to be as much as 190 m. Similarly, the minimum safety separation distances are specified between parallel taxiways; these should be 97.5 m to allow unimpeded use by aircraft of up to 80 m wingspan (see Table 6-3).

Table 6-3 Taxiway minimum separation distances

Code letter	Distance between TWY centre line and RWY centre line [m]				TWY centre line to TWY centre line [m]	TWY, other than aircraft stand taxilane, centre line to object [m]	Aircraft stand taxilane centre line to object [m]
	Instrument runways code number						
	1	2	3	4			
A	82.5	82.5	-	-	23.75	16.25	12
B	87	87	-	-	33.5	21.5	16.5
C	-	-	168	-	44	26	24.5
D	-	-	176	176	66.5	40.5	36
E	-	-	-	182.5	80	47.5	42.5
F	-	-	-	190	97.5	57.5	50.5

Note: Data for non-instrument RWYs are not shown.

Source: ICAO Annex 14, Aerodromes, Volume I, Aerodrome Design and Operation 4th edition

The effect of these separation standards for Code F is shown by the total investment of £450 million that Heathrow has made in order to accept the A380. Many of the piers have had to be shortened and many of the stands closest to the runways have been lost because the inner taxiway clearance line has been moved 40 m closer to the buildings. The runways have been widened and the runways and taxiways have had new shoulders. A new pier has been built with 4 A380 stands.

This may be contrasted with the A380 acceptance at Hong Kong where, because it is a third generation jet airport rather than a pre-jet one, only minor changes have been necessary to the airside, like moving objects from the Code F taxiway strips and changing stop-bars. The separation requirement between parallel taxiways is based on the wing tip clearance requirement when an aircraft has deviated from the taxiway centre line (Figure 6-6).

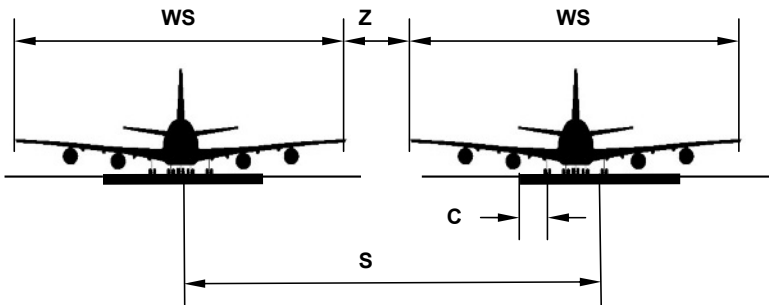

Figure 6-6 Parallel taxiways separation

(Source: ICAO Doc 9157 Part 2)

The formula for the separation distance in this case is:

$$S = WS + C + Z$$

where:

WS - wing span

C - clearance between the outer main gear wheel and the taxiway edge (maximum allowable lateral deviation)

Z - wing tip clearance.

Separation distances in FAA taxiway design standards are different from the ICAO ones. They are based on allocation of aircraft into 'airplane design groups' and FAA uses different formulas from ICAO for calculations.

In line with the ICAO and FAA standards, taxiways on aprons and stands are split into two groups: **apron taxiways** which are located directly on aprons and **taxilanes** providing access to aircraft stands (Figure 6-7). Standards for both of them are generally the same as for the 'classic' taxiways except the separation criteria. Separation can be less stringent in the case of apron taxiways and taxilanes because the aircraft taxi more slowly at the apron areas.

The category of approach aid affects the protection which must be given to those electronic aids. ILS signals may suffer interference from a stopped or taxiing aircraft in ILS critical and sensitive areas particularly during Cat II or Cat III system operations (see also Chapter 3, part Low Visibility

Procedures). The information on the ILS and MLS critical and sensitive areas are given in Annex 10, Volume I, Attachments C and G.

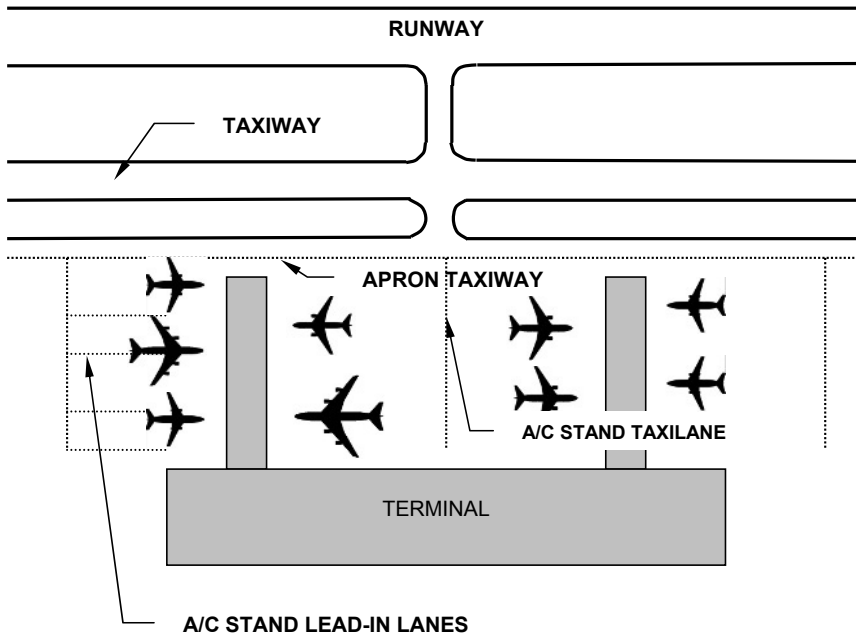

Figure 6-7 Taxiways on apron

6.4 TAXIWAY GEOMETRY

Depending on the code letter of the runway, minimum margins of safety between 1.5 m to 4.5 m should be provided between the outer main gear wheel edge and the taxiway edge when the cockpit is over the taxiway centreline.

The resulting taxiway width of the taxiway is less than the width of corresponding runway because aircraft taxi speed is considerably slower than the speed on take-off or landing. The taxiway width needs to be between 7.5 m (code letter A) to 25 m (code letter F). The taxiway width, W_T is based on a formula:

$$W_T = T_M + 2C$$

where:

W_T - taxiway width on the straight parts of the taxiway

T_M - outer main gear span

C - clearance between the outer main gear wheel and the taxiway edge
The clearance value depends on the taxiway code letter (Figure 6-8).

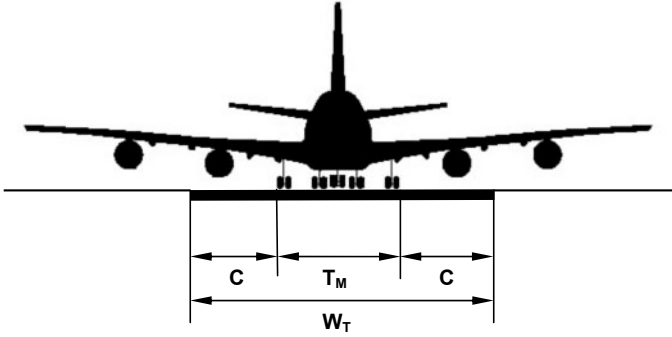

Figure 6-8 *Taxiway width requirements*
(Source: ICAO Doc 9157 Part 2)

Taxiways need to be widened with fillets where they have sharp curves so that the necessary safe separation distance between the outer main gear wheel edge and the runway edge may be maintained when the nosewheel is tracking the centreline, see Figure 6-9.

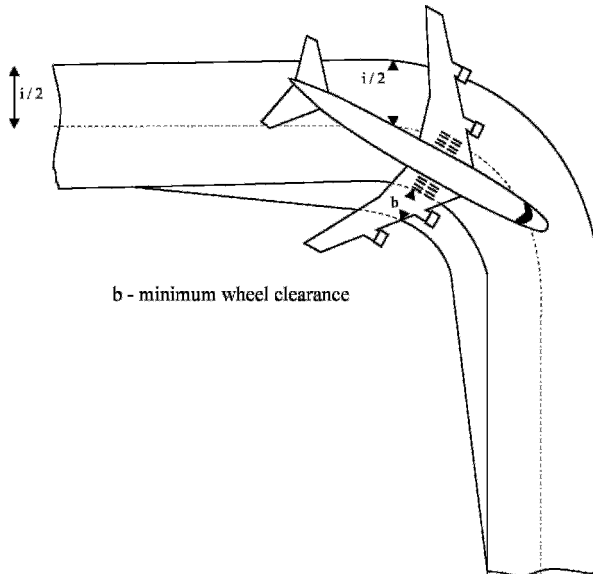

Figure 6-9 *Taxiway widening to achieve minimum wheel clearance on curve*

There are commercial programmes available that simulate the tracks of all the wheels for all the main types of aircraft. Occasional movements of an aeroplane with greater gear track than that for

which the taxiway was designed can be accepted by steering the nosewheel outwards from the centreline (Figure 6-10).

As with runways, taxiways may also be provided with shoulders. Since the speed of aeroplanes moving on a taxiway is quite slow, the main function of the shoulders is to prevent ingestion of foreign objects by an aeroplane's engines. They must also prevent erosion of the surface by engine exhaust gases. They also provide a gradual change from the taxiway bearing strength to that of a taxiway grass strip. The width of a taxiway shoulder is determined by the need to meet these requirements and the aircraft's characteristics. A taxiway shoulder is usually constructed as a light asphalt pavement.

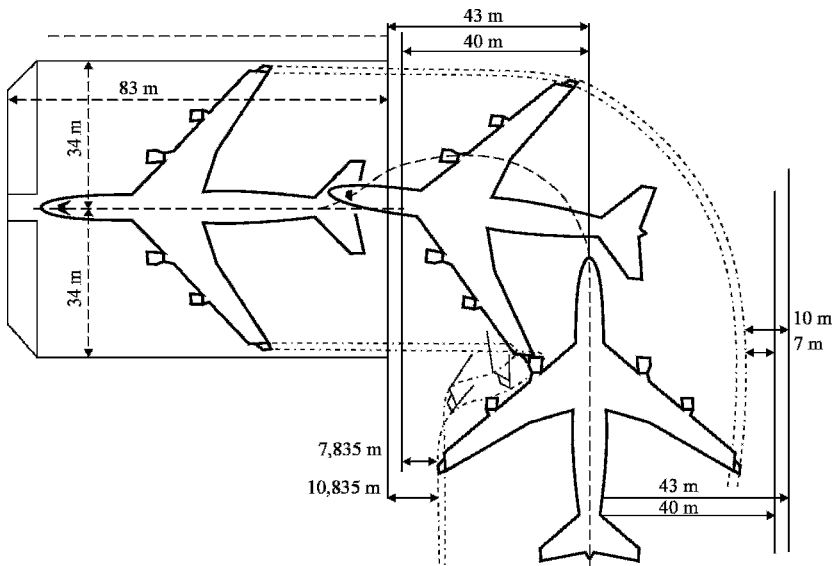

Figure 6-10 *Realigning the front undercarriage guide line outwards from the centreline for B-747-400*

Taxiway strips extend from the edge of a taxiway. Their function is similar to that of a runway strip. For a specified distance from the centre line of a taxiway, the grass surface of the taxiway strip should be well-maintained, without obstacles and the prescribed slopes of the strip should be maintained.

Other physical characteristics of a taxiway, including longitudinal slopes, transverse slopes and a change of the transverse slope of a runway also depend on the code letter of the associated runway. A further requirement is for clear visibility from any point on the taxiway surface to a point on the

taxiway 150 m or 300 m away, measured at a height of 1.5 m or 3 m, the distances and heights depending on the code letter of the respective runway.

At many large airports there are limited possibilities for runway or taxiway system expansion. This sometimes leads to concepts where taxiways must bridge other transport infrastructure such as motorways, roads, railway lines, etc. Besides the basic requirements on the bridge structural design, the taxiway layout must guarantee that taxiing on bridges does not impose any difficulties on pilots during day or night operations, low visibility or other adverse conditions. A taxiway on a bridge must fulfil all requirements for standard taxiways. Besides this, taxiways on bridges should also:

- Be always located on a straight part of the taxiway. The length of the straight sections should be at least twice the wheel base of the largest aircraft in addition to the length of the bridge. This facilitates a pilot in aligning the aircraft on the taxiway centreline before crossing the bridge.
- All surface modes that must be bridged should be concentrated in one place to minimise the number of taxiway bridges.
- Protection against jet engine blast should be provided on places where a taxiway bridge crosses other transport mode structures. For this purpose, light cover structures such as grid or bar constructions which reduce initial jet blast are usually used.

If a runway requires a bridge, rapid exit taxiways should not be located on the bridge.

Sometimes it is not clear which aircraft types will use the airport in the future. To prevent a costly reconstruction once a larger airplane begins to operate on the airport the taxiway bridge should be designed for a higher code letter.

The taxiway strip on the bridge structure has the same characteristics and bearing strength as the taxiway pavement. This facilitates not only snow clearance during the winter season but also emergency vehicles' access to the bridge.

7

APRONS

Tony Kazda and Bob Caves

7.1 APRON REQUIREMENTS

Aprons are designed for parking aeroplanes and turning them around between flights. They should permit the on and off loading of passengers, baggage and cargo, and the technical servicing of aeroplanes including refuelling.

The requirements for the construction of aprons are similar to those of the other reinforced surfaces. It is mentioned in Chapter 8 that the aprons are the most heavily loaded of all the movement area pavements. The aeroplane has its maximum mass on the apron just prior to departure. The surface is subject to concentrated point loads from the wheels of standing or slowly moving aeroplanes. In addition, it is dynamically stressed by vibrations after starting up the engines. Therefore, when calculating the apron pavement thickness, a safety factor of 1.1 is used.

In the past, concrete was used almost exclusively for apron pavements. The original concrete aprons are often renovated by covering them with layers of asphalt. Asphalt is also commonly used for aprons on aerodromes intended for use by small or medium-sized aeroplanes. However, asphalt pavements are frequently damaged by spilled kerosene or gasoline if it remains on the

surface for even a short period of time. This can be partially solved by treating the top asphalt layer with special sealants. It is mentioned in Chapter 8 that there is increased use of block paving for aprons.

In order that aeroplanes can park and taxi out under their own power, the slopes should be minimised but still be sufficient to allow the surface water to drain adequately. In the aircraft parking area, the maximum slope of the apron should not exceed 1%. To enhance apron fire safety, in particular with respect to aircraft fuelling, apron pavements should slope away from a terminal to prevent the spread of the fuel fires in the direction of the terminal building.

The apron is a bridging point between the runway system and the terminal building. The location of the apron and its aircraft stands should allow convenient access. The following are some of the basic requirements that should be objectives when designing the apron:

- location of the apron to minimise the length and complexity of taxiing between the runway and the stands
- the apron should permit mutually independent movements of the aeroplanes on to and off stands with minimum delay
- on the apron it must be possible to locate a sufficient number of stands to cope with the maximum number of aircraft expected during the peak hour
- the apron should be adequate to allow quick loading and unloading of passengers and cargo
- the apron should be designed so that there is sufficient space for the turnaround activities to be performed independently of activities on an adjacent stand.
- the apron area should be adequate to provide sufficient space for parking and manoeuvring of the handling equipment, and also for the technical personnel
- there should be a safe and effective system of airside roads for technical equipment to access the stands, preferably avoiding the need for aircraft to cross them to access the taxiway system.
- they should be clearly marked with the width of each lane able to accommodate the widest piece of ground equipment
- the negative impacts on the workers' environment, particularly safety, noise and exhaust gases should be minimised, the emphasis being the health and safety of the staff and passengers accessing aircraft across the apron.
- the possibility of further extension of the runway system, aprons and buildings should be considered.

Each of these requirements has an effect upon the final design of the apron.

In addition to the passenger terminal aprons, there are also other special purpose aprons such as general aviation and cargo terminal aprons satisfying particular requirements. In addition to them, some airports may also need a certain number of stands located at a separate parking area where aircraft can be placed for extended periods. These aprons can be used for periodic servicing or maintenance of temporarily grounded aircraft. Another requirement is for a remote stand where aircraft suffering a terrorist threat may be isolated (see section 7.7). Regardless of the apron function, apron physical characteristics relating to safety and geometry are universal for all apron types.

7.2 APRON SIZING

The above objectives can only be achieved if the apron size and the positioning of the stands are adequate to permit expeditious handling of the aerodrome operation during predicted peak hour traffic levels.

The appropriate apron size depends on the types of aircraft which are intended to use the apron, but the shape and apron layout also depends upon a number of other geometric considerations. In addition to the aircraft stands, the over-all apron area also includes space needed for apron taxiways and taxilanes, safety clearances, space for blast fences, service roads and areas designated for ground equipment and vehicle placement.

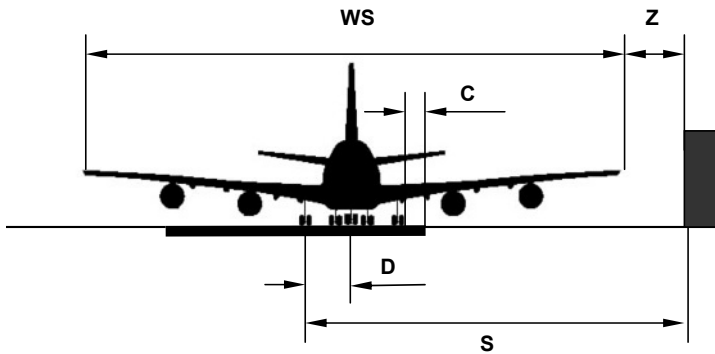

Figure 7-1 Apron taxiway to object geometry

The size and shape of land available also influence the stand types and apron layout concept. The diagram (Figure 7-1) explains how the Annex 14, Volume I separation standards are derived. The minimum separation distance between the aircraft wing tip and an object when the aircraft deviates

from the apron taxiway centre line is defined by a formula:

$$S = WS/2 + D + Z$$

where:

- WS - wing span
- D - lateral deviation of the aircraft's longitudinal axis from the taxiway centreline
- Z - wing tip clearance
- C - clearance between the outer main gear wheel and the taxiway edge at the maximum allowable lateral deviation from the taxiway centreline

Areas required for contact stands vary from 0.22 hectares for Code B regional jets to 1.50 hectares for Code F A380. The stand depths required vary from 30 m to 85 m for Codes B and F respectively.

Each aircraft type needs sufficient stands in the correct position, and possibly a specific manner of stand operation, either nose-in or inclined for self-maneuvring. There may also be specific requirements for technical servicing (e.g. refuelling), for technical equipment, and for guidance to the parking position when nose-in operation is used. The accuracy of the aircraft guidance on the apron may have an effect upon the size of the apron.

The total apron area depends also on the type of the operation prevailing on the aerodrome and the occupancy time of stands. For some airline operators, the aerodrome may serve as a base; for others, as a departure/arrival aerodrome or only as a transit stop. The based aircraft normally have a greater occupancy time between arrival and departure, so much so that it may be better to consider towing them off to remote stands.

In order that all the factors that influence the apron size may be considered, particularly with large aerodromes, it is advisable to simulate the operations on the apron. Similarly, the operational control of the apron, e.g. stand allocation, is computerised at large airports.

7.3 APRON LOCATION

Theoretically, the most efficient location for the apron is at a distance of 1/3 length of the runway from the main runway threshold, (Figure 7-2), based on a normal split of use of the two runway thresholds.

When determining the apron location and orientation, the following objectives should be taken into account:

- minimum length of taxiing of the aeroplanes
- the shortest distance possible from the walkway in front of the terminal building to and from the aeroplane
- minimum impact of the engine exhaust on the terminal building
- possible expansion of the apron as well as the terminal building.

In the majority of cases, the apron is constructed directly in front of the terminal building, allowing the stands to be served by airbridges if they are deemed to be necessary. If bridges are not provided, some other safe way of getting the passengers to and from the aircraft will be needed, using well-policed walkways or buses. Preferably, the airside service road runs under the airbridges; otherwise it has to run between the back of the stands and the taxiways.

In some other cases, the whole apron, or a section of it, is constructed at a considerable distance from the terminal building. Then it is necessary to provide some form of transport of passengers between the terminal building and aeroplanes. This increases the operating costs. There are many reasons why an apron might be located remotely.

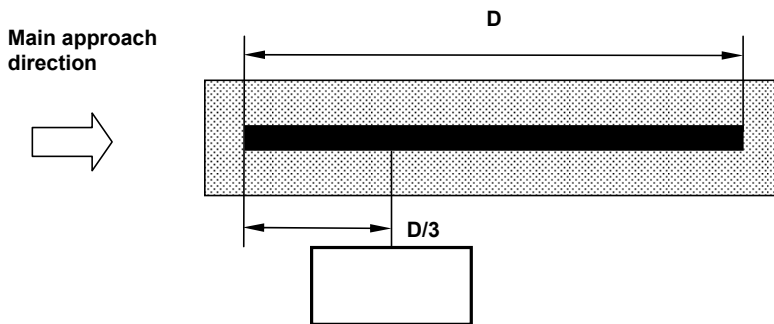

Figure 7-2 *Apron location*

It may be to try to create a comfortable ambience in the terminal building and to reduce walking distances as with busses at Milan Linate or the mobile lounges at Montreal's Mirabel airport, a need to earmark a section of the apron for longer-time parking of aeroplanes as at Washington Dulles International Airport, to generate the space to handle large aircraft as at Los Angeles, or to provide a cost-effective way of handling the additional peak hour traffic as at Munich or Rio Galleao. In the majority of cases, it has been the practice for the airport operator to allocate the contact stands (those directly adjacent to the terminal building) for high-capacity aircraft and scheduled airlines, particularly if they are part of a hubbing operation.

7.4 APRON CONCEPTS

The geometric and manoeuvring characteristics of aeroplanes make it practically impossible in most cases to locate all the stands required for peak traffic directly adjacent to the central processing part of the terminal building. It is therefore necessary to generate other solutions. Several basic concepts that have developed over time may be identified, depending on the total size of the airport. Each concept has its advantages and disadvantages, so the solution is often a compromise and a combination of the basic concepts discussed below. Apron design must be consistent with the adjacent terminal. Apron and terminal design is an iterative process where the optimum combination of apron and terminal concepts are analysed at the same time.

7.4.1 Simple Concept

This concept is used normally at very small airports with a few movements of commercial aircraft a day. Stands are always the ‘self-manoeuving’ type. Aircraft parking positions (angled nose-in or nose-out) usually depend on the terminal frontage and the slope of the apron to minimise engine jet blast or propwash on the terminal building (Figure 7-3).

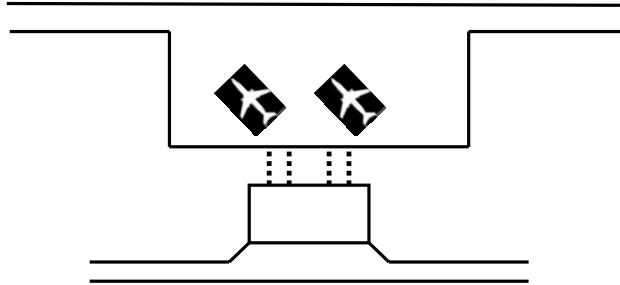

Figure 7-3 Simple concept
(Source: ICAO Doc 9157 Part 2)

7.4.2 Linear Concept

At many airports the simple concept develops gradually to the linear concept. Individual stands are located along the terminal building (Figure 7-4) as at Munich and Roissy-Charles de Gaulle-Aérogare 2 and 3. A modification of that concept may be found in large airports where the stands are placed along several parallel passenger loading piers (or satellites) that are connected with one another and also with the central terminal by a transport system, as at Atlanta Hartsfield, and

planned for Heathrow-Terminal 5. An advantage of the linear apron concept is the simple access from the terminal building to the aeroplanes, a simple installation of the passenger loading bridges and sufficient space for technical handling equipment and staff at the level of the apron.

A service road is usually placed between the terminal frontage and the apron to facilitate ground vehicle and handling equipment circulation. A disadvantage in larger airports may be the large distance between the extreme stands and the central processing point in the terminal building, and sometimes an even larger distance to another stand for transfers between airlines.

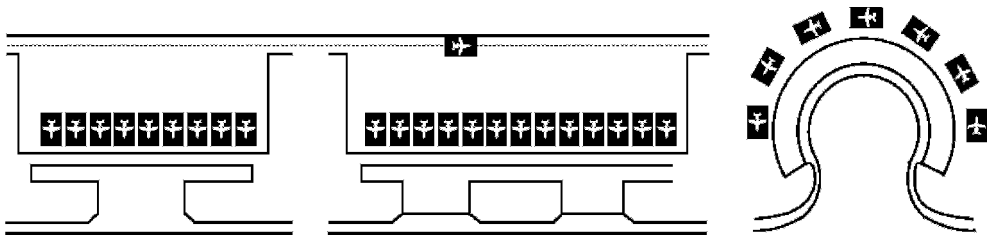

Figure 7-4 Linear concept
(Source: ICAO Doc 9157 Part 2)

The latter problem may be solved by people movers. There is now pressure on airports to rearrange the stand allocations to ensure short transfer distances between flights within an airline grouping, so giving the carrier's hub a competitive advantage. Generally the linear concept provides a very flexible solution where the apron could be easily expanded without disrupting the flow of traffic. The concept cannot be extended easily beyond 15 mppa.

7.4.3 Open Concept

In this concept, the stands are located on one or more rows in front of the building (Figure 7-5). One of the rows may be close-in, but most will be a long way from the terminal. The transport of passengers to the distant stands is provided by buses or mobile lounges, with only a short walk for passengers. Milan Linate is an example where almost all the aircraft stands are on open aprons. The concept allows many aircraft to be served from a very short terminal frontage. Apron location can be optimised with respect to aircraft operations i.e. close to the runway to minimise taxi distances and fuel burned. Expansion is easy. Servicing is usually done from islands set out in the middle of the aprons.

A main disadvantage is the need to provide transport to distant stands for all passengers, requiring a large workforce and fleet of buses. The length and lack of reliability of these bus trips makes the concept unsuitable for operations with transfer passengers. Flights are subject to a very early close-out. Another disadvantage is the large number of additional movements on the apron, increasing the possibility of accidents with aircraft and other ground vehicles.

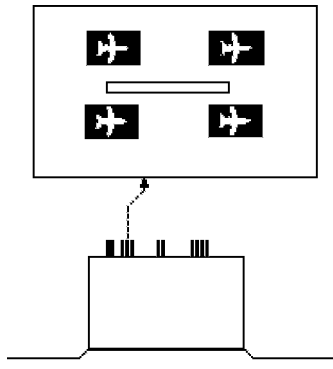

Figure 7-5 *Open concept*
(Source: ICAO Doc 9157 Part 2)

7.4.4 Pier Concept

In many large airports, the introduction or extension of piers was the most convenient way of providing a greater number of contact stands and to increase the capacity of the airport while providing weather protection for the passengers.

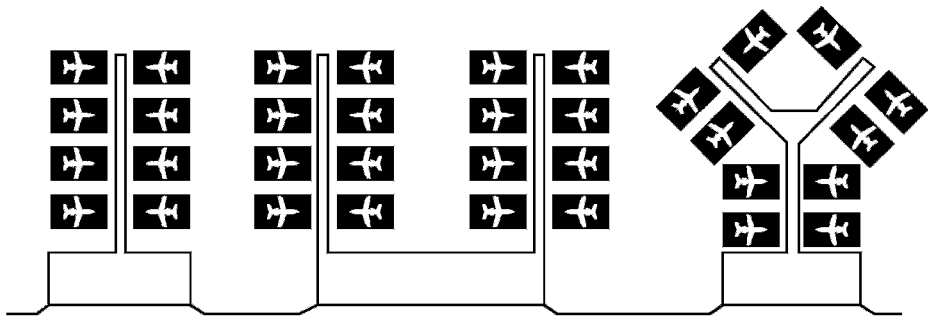

Figure 7-6 *Pier concept*
(Source: ICAO Doc 9157 Part 2)

The shape of the passenger loading piers varies and depends on the space available at the airport (Figure 7-6). Amsterdam Schiphol and London Heathrow airport (Figure 7-7), are classic examples of such a solution. Piers have the advantage of keeping all the gates under one roof, allowing direct contact with the central processing area and a relatively simple navigating task for transferring passengers. The footprint of the terminal and apron complex can be kept quite compact, particularly if the piers are double-sided. For this apron concept, only nose-in stand types are used. Aircraft can be parked at the stand either angled to reduce stand depth, or more normally perpendicular to the pier.



Figure 7-7 Pier system at London Heathrow Airport (Photo: A. Kazda)

Piers generally involve the aircraft having to taxi into cul-de-sacs to get to the stands. The limited space leaves little extra room for aircraft handling. There is usually only a small parking bay for equipment and service personnel under the piers. In the confined space, the effects of noise and exhaust fumes create poor working conditions for the staff. Any increase in aircraft size tends to result in congestion on the cul-de-sac taxilanes, particularly if they have only a single lane. It is imperative to have dual lanes if there are more than 10 or 12 stands in the cul-de-sac. Future larger aircraft operation must be considered during planning process to avoid costly reconstructions. The concept is probably able to cope up to 45 mppa, but distances become very long.

7.4.5 Satellite Concept

In this concept, each of the remote passenger loading satellites is connected with the terminal building by underground tunnels or by overhead corridors, as in Figure 7-8. The satellites may be any shape from linear as at Atlanta Hartsfield to circular as with Charles de Gaulle Terminal One (CDG T1). Typically, the number of stands at circular satellites varies between 4 to 8 aeroplanes but the linear ones may well have 20 stands per side. The larger ones are usually sited in mid-field, their length being limited by the separation between the runways. Satellites, as opposed to unit terminals, imply that the processing takes place centrally, but in some cases there is a degree of decentralised processing, particularly with security screening. Given a suitable gate assignment system, this concept is good for hubbing, except for international/domestic transfers that require clearing through the central terminal.

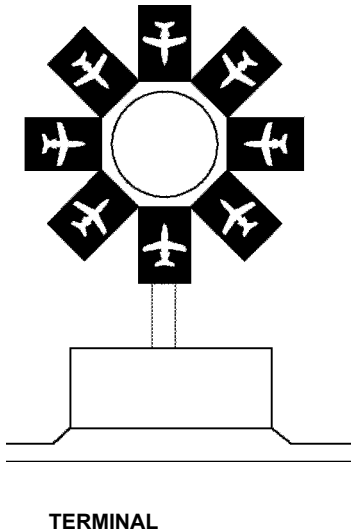

Figure 7-8 **Satellite concept**

There is ample space for aircraft servicing, particularly around a circular satellite. Also push-back operations are simple and safe. The satellite concept avoids cul-de-sacs and their disadvantages. However, it requires a larger total apron space. Since the distance from the terminal building to the aeroplane is considerably extended, it is necessary to transport passengers between the terminal building and the satellites, usually with a high frequency automated people-mover, though sloping moving walkways are used at CDG T1.

Connections are often below the surface to allow the whole perimeter to be used for parking, but sometimes the connection is over-ground, allowing some contact stands to be

located along the connectors. This can be an efficient use of space. Depending on the size and the shape of the satellite, aircraft can be parked radially or parallel to the sides of the satellite.

7.4.6 Hybrid Concept

At many airports combination of two or more above mentioned concepts is usual. During the summer peak season it is quite common to park some, especially charter aircraft, on the remote apron and transport passengers by busses or transporters to the aircraft stands.

7.5 STAND TYPES

There are several types of aircraft stands. The two most common are ‘taxi out’ and ‘nose-in’ stands. The ‘taxi out’ stand is also sometimes referred to as ‘self-maneuvring’. The aeroplane taxis in and out under its own power. The alternative is a ‘nose-in’ or ‘tractor assisted’ stand. The aeroplane taxis in under its own power, but to leave the gate it must be pushed back into a specific position usually through 90 degrees onto the adjacent taxilane. In most cases, the engines may not be started until the push-back is complete. The separation clearance between the aircraft parked on the stands and the adjacent taxilanes is defined by formula (Figure 7-9):

$$S = WS/2 + d + Z$$

where:

- WS - wing span
- d - lateral deviation from the taxilane centreline
- Z - wing tip clearance

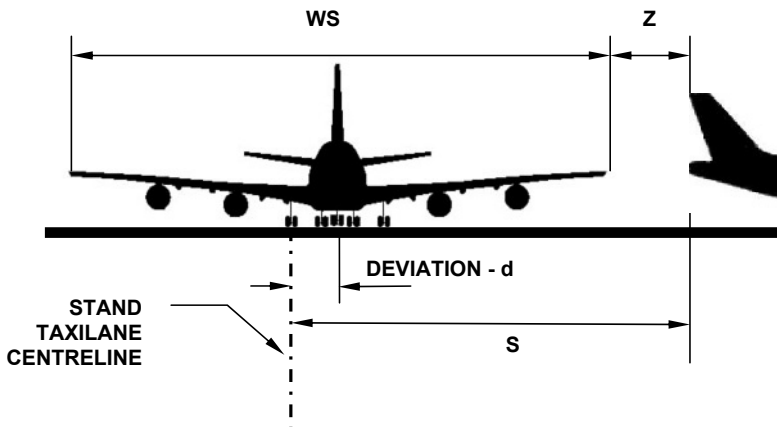

Figure 7-9 Aircraft stand taxilane to object geometry

(Source: ICAO Doc 9157 Part 2)

Taxi out (or *self-maneuvring*) aircraft stands are mostly used at small airports with a small number of movements. Advantages of the taxi out aircraft stands are their low operating costs, in the majority of instances daily inspection of the stand surface and marking of the apron is sufficient. They have good flexibility and only require a marshaller, whereas the nose-in arrangement is usually equipped with a docking guidance system and needs the push-back equipment and staff for the push-back operation. This type of operation makes it almost impossible to use a passenger loading bridge, approximately 20 per cent more space is required, and jet blast can be a problem.

Approximately 10 stands of the nose-in type may be positioned in the same space as 8 taxi out aircraft stands, thus increasing the apron utilisation. The self-maneuvring stands may overlap one another but, if they do, simultaneous movements of the aeroplanes on adjacent stands are not possible, as shown in Figure 7-10 where:

- d - distance between the stands turning centres
- R - aircraft turning radius
- b - stands overlap
- y - alignment distance.

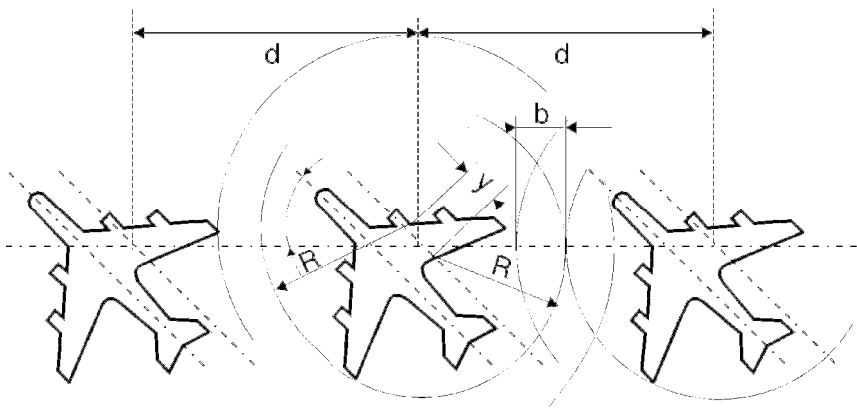

Figure 7-10 Individual stands overlap

The size of the taxi out aircraft stand depends on the turning radius, wing span and the fuselage length of the aircraft. When the aeroplane turns, a so called safety distance between the wing tip and an obstacle should be ensured, as shown in Figure 7-11.

When the aeroplane is turning, particularly if it has a multi-wheel main undercarriage, there is a considerable shear stress on the pavement. Pavements with an asphalt surface are often damaged in this way. Another disadvantage of the power-out stands is the effect on the terminal building, on other objects, or on the traffic on the apron produced by the engine's exhaust plume at brake-away thrust and during turning. In order to start the aeroplane rolling, the brake-away thrust requires up to 50-60% of the maximum continuous thrust, while turning requires approximately 25-30%. In contrast, in normal taxiing of aircraft with high bypass ratio engines, there is often too much power even at ground idle settings. Figure 7-12 gives velocities of the exhaust gases of the aeroplane B-767-200 at brake-away on the stand.

Nose-in aircraft stands are normal at airports with a high density of operations. Besides being space-efficient, they also facilitate the use of passenger loading bridges, which may be apron drive bridges with three degrees of freedom or nose loaders which do not have articulation in azimuth,

these latter requiring a more accurate positioning of the aircraft. They can all mate with the second door on the left side of the aircraft if there is sufficient vertical flexibility to reach down to the smaller jets.

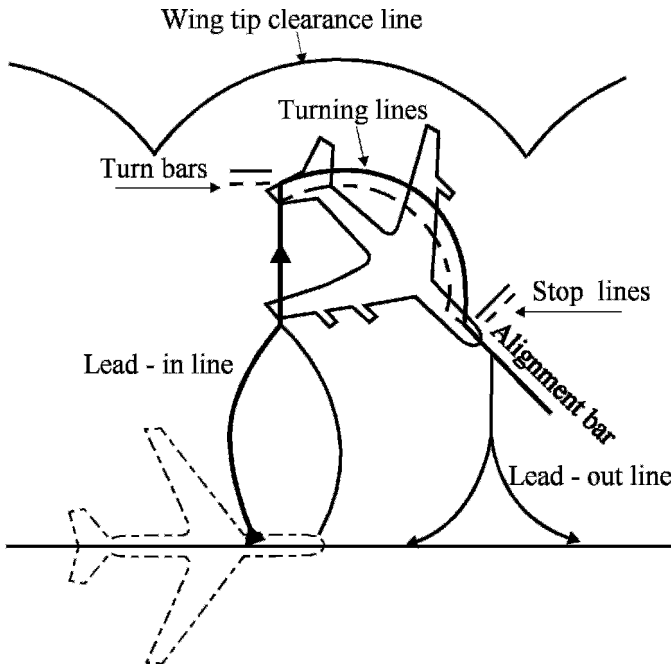

Figure 7-11 Aircraft stand markings

At some airports more airbridges are used to speed up the movement of passengers, even in some cases reaching over the wing to the rear door, though IATA does not recommend this. It is estimated that a third bridge to the A380 will save 19 minutes on boarding and 12 minutes on disembarking. IATA does suggest that a world class airport will serve 90 % of passengers by airbridges. Using push-back tractors allows closer spacing of this type of stand, thus reducing the apron size.

Normally the push-back takes in average 2 - 4 minutes depending on the size of aircraft, type of push-back tractor (with tow-bar or towbarless) and on the position where are engines started-up (at the stand or after push-back). They cost more to equip and operate than the self-manoeuving type. As well as the air bridge, if it is provided, there are the tractors and parking guidance systems to be provided. There may well also be hydrant fuel systems and fixed power installations, which are more appropriate for push-back stands than for the more flexible open-apron power-out operations.

The details related to technical servicing of aeroplanes on both stand types are given in Chapter 9.

On the stands, the aeroplanes may be positioned nose inwards, at an angle nose inwards, nose outwards, at an angle nose outwards, and parallel to the terminal building, as shown in Figure 7-13. Each solution has its advantages and disadvantages.

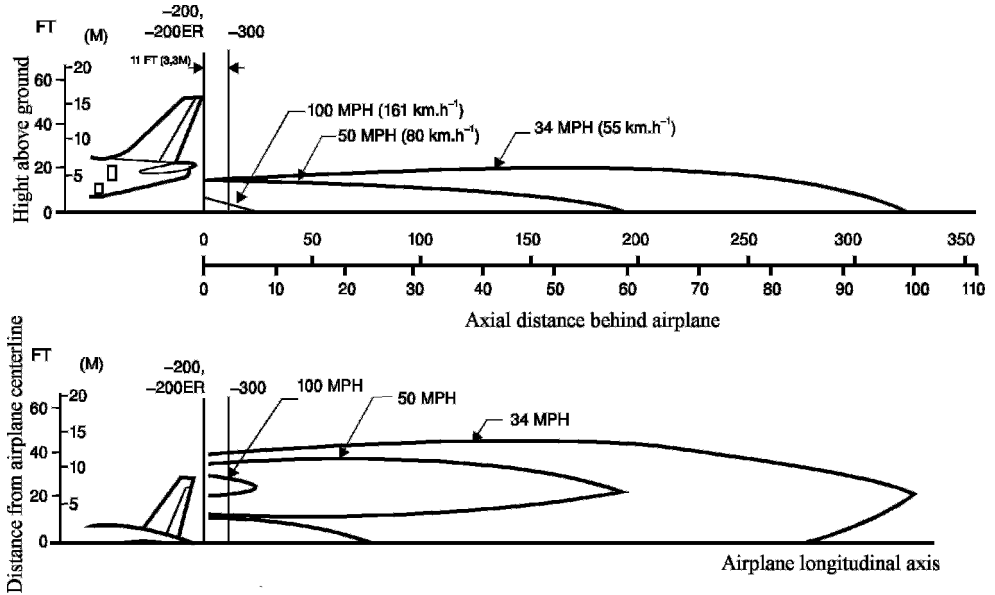

Figure 7-12 *Jet engine exhaust velocity contours – brake-away thrust
B 767-200 (CF6-80A engine)*

- Conditions:*
- sea level
 - still air
 - stationary aeroplane
 - thrust 38.6 kN (8 500 lb), each of the engines
 - both engines in operation

On the nose in–push back aircraft stands (Figure 7-14), the aeroplanes are located either directly nose inwards, or at an angle between 30° to 60°. The angle depends on the size, shape and layout of the apron. Fundamental requirements are for an aircraft on stand not to overlap the required separation from the adjacent stand, not to block the apron taxiway behind it, for the tail not to conflict with the transitional protection surface associated with a runway and for the tow tractor not to block the service road in front of the aeroplane when initiating push-back.

On self-maneuvring stands, the aeroplanes may also be theoretically parked in any of the above positions. However, the ‘nose inwards’ or the ‘nose outwards’ placement, i.e. perpendicular to the terminal building edge are normally not used because the stands cannot overlap one another (see Figure 7-10), and thus the aeroplanes would occupy the maximum area.

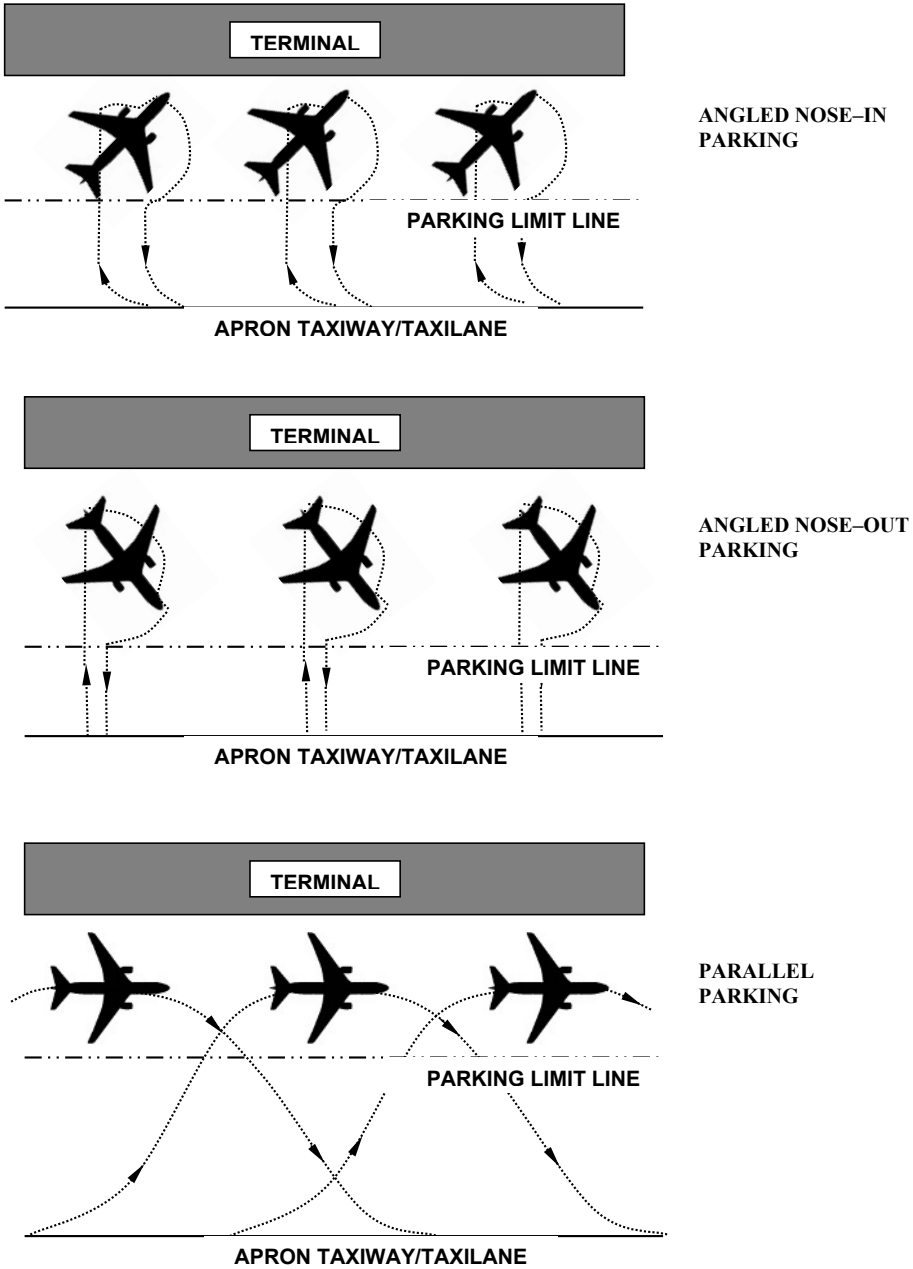

Figure 7-13 Positioning of aeroplanes on the stands
(Source: ICAO Doc 9157 Part 2)

Placing the aeroplane parallel to the terminal building is convenient particularly due to the fact that the passenger loading bridges may be installed to both the front and the rear door of the aeroplane. A disadvantage is that after starting up the engines, it is practically impossible for the aeroplane on the stand behind to be serviced.

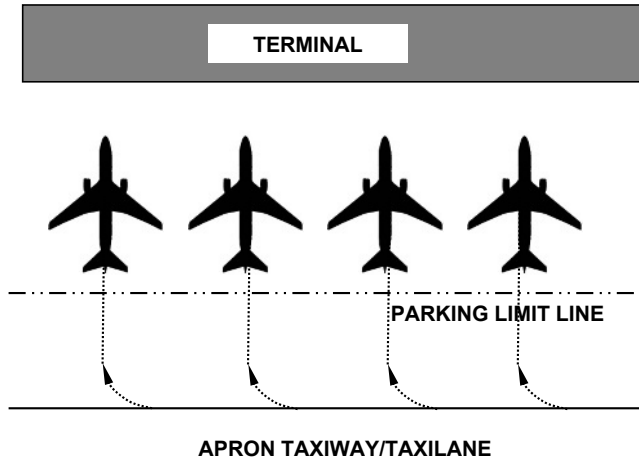

Figure 7-14 *Nose-in stands for pushback operations*

(Source: ICAO Doc 9157 Part 2)

Therefore this parking arrangement is also used only rarely, and only at airports with a sufficiently large apron, a low frequency of flights or with the circular satellite stand concept. On self-maneuvring stands the aircraft are most often parked at an angle of between 30° and 45° inwards or outwards from the terminal building frontage where the maximum overlap is possible, depending on the aircraft type. In spite of the fact that individual stands overlap one another, the prescribed safety distance should be provided between the wing tip of the moving aeroplane and the aeroplane on an adjacent stand. However, the aeroplane on the adjacent stand must be at a standstill. The orientation of the aeroplane inwards or outwards depends also on the slope of the apron. Although the slope of the apron is strictly limited, its effect on the brake-away thrust required for an aeroplane with the maximum mass is significant. Therefore, at the beginning of the power-out manoeuvre, the aeroplane should face in the direction of the declining slope.

To relieve the dynamic effect of jet blast on neighbouring taxi-out stands and the terminal building during the aeroplane turning manoeuvring, blast fences may be placed on the edges of the stand to reduce the blast speed to less than 56 km/hr. The fences usually consist of sets of steel vanes which turn the jet exhaust upwards (Figure 7-15). The height of the walls on the apron is limited and in most cases does not exceed 3 m. Because of this they are effective for under wing mounted engines only. Much larger blast fences are often installed to protect public areas around aprons, as

at Heathrow Terminal Four. They may be in the form of a latticework rather than vanes, as at East Midlands airport in the UK.



Figure 7-15 Blast fence (Courtesy Bratislava M.R. Štefánik Airport)

7.6 APRON CAPACITY

At a properly dimensioned aerodrome, the capacity of all parts of its system is in approximate equilibrium. There are then no critical bottlenecks in the system. Some portions of the aerodrome can bear a short-term overload, others cannot. The apron should be dimensioned in such a way that peak hour delay is an acceptable minimum, say no more than 2% of flights. To cope with these small number of movements, and to ensure that delays do not back up onto the taxiways or into the air, the capacity of the apron may be increased by establishing parking ramps away from the terminal building. Such stands are usually not equipped with any technology. In the majority of cases, they are used for charter flights and for aircraft waiting for on-line repairs, but are extremely useful to accommodate aircraft that would otherwise block taxiways while waiting for specific stands to become available. Typically, the number of parking ramps might amount to 10% of the number of stands on the apron, depending on the types of operation at the airport. Cargo aprons

can often be brought into play for this purpose, since the daily peaking characteristics are different.

The number of stands on the apron depends not only on the number of movements of the aeroplanes, but also on their distribution during the day, the length of stay on stand, and on the aircrafts' dimensions and seat capacity. Theoretically, the required number of stands may be expressed by a formula:

$$N = k \cdot \frac{t \cdot n}{120}$$

where:

- N number of stands
- k coefficient of variability of use of the stand. It depends on the total number of stands and their types, on the structure of flight timetables, and allows for the time taken to clear a stand after the doors close and the time the stand becomes available for the next aircraft. It ranges between 1.3 to 2.0
- t aircraft turn around time in minutes
- n number of movements in peak hour.

A determination of the required number of stands by simulation is more appropriate and precise, but requires the construction of an accurate representative schedule.

7.7 ISOLATED AIRCRAFT PARKING POSITION

An isolated aircraft parking position should be established on each aerodrome for parking any aeroplane which is known or believed to be the subject of unlawful interference. The isolated parking position should be located at the minimum distance of 100 m from other parking positions, buildings or public areas. The position should not be located over underground utilities (fuel, gas, electrical, light-current cables).

8

PAVEMENTS

Tony Kazda and Bob Caves

8.1 BACKGROUND

The choice of the kind of pavement depends on the characteristics of the aeroplanes which are intended to use the aerodrome or the respective runway, operational requirements (particularly with respect to reconstruction of the runway) and geological conditions. Requirements for pavement bearing strength, longitudinal and transverse slopes of runways and other movement areas, pavement texture and braking action are all specified by Annex-14, Aerodromes, Volume I and amplified in the Aerodrome Design Manual, Part 3, Pavements. Operational regulations of individual airport administrations complement these requirements and offer guidance on the occasional excessive loading of pavements.

It is not an objective of this chapter to give instructions on how to dimension the pavement structure, which is the construction engineer's responsibility. But nevertheless, the staff from the operational department of an airport should have at least a basic knowledge about designing aerodrome pavements so as to be able, based on their understanding, to monitor the pavement condition and manage maintenance and reconstruction. Some characteristics of existing aerodrome pavements differ from those of road pavements.

The whole aerodrome pavement should comply with four basic requirements:

- its bearing strength must be appropriate to the operation of the aeroplanes which are intended to use the aerodrome
- it should provide good ride capability of an aeroplane during its movement on the runway by preserving a smooth pavement
- it should provide good braking action even on a wet surface
- it should offer good drainage capability.

The first requirement refers to the pavement construction, the second to geometrical characteristics of the surface, the third one to the texture of the pavement surface and the fourth one to both the geometry and the texture.

All the four criteria are fundamental and complement one another. It is the only way for a pavement to fulfil the operational requirements. From the operational viewpoint, the most important are the third and fourth requirements because they have a direct impact upon the safety and regularity of the aerodrome operation. Thus the requirement for a long-term provision of good longitudinal friction coefficient (f_p) may affect the choice of a pavement construction and surface.

8.2 PAVEMENT TYPES

The choice of a pavement construction type is influenced by many factors.

Table 8-1 Pavement types

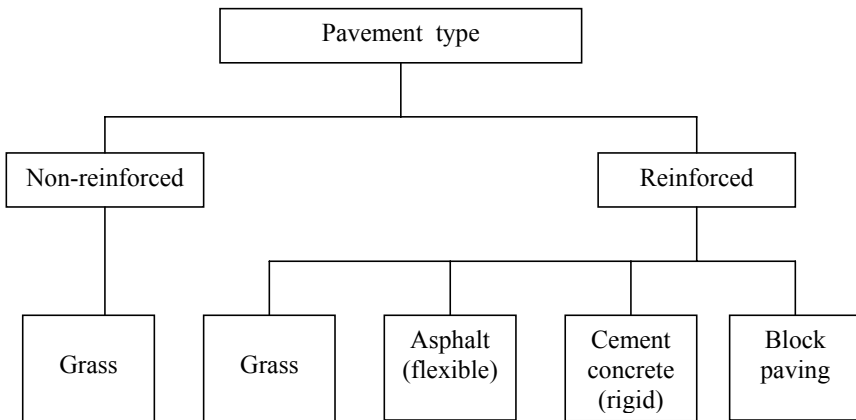

In particular, the following factors are important:

- types of aeroplanes from the viewpoint of the maximum point load for which the aerodrome is

intended, and other operational requirements

- availability and price of suppliers, materials and works
- geological conditions,
- prevailing climatic conditions.

The basic division of pavement types is given in the Table 8-1. In some states e.g. in Brazil or in the USA compacted earth strips are also used at general aviation airports. The Brazilian ones are formed from what they call pre-laterite soil.

8.2.1 Non-Reinforced Grass Strips

The non-reinforced grass strips which may be employed in most climatic conditions year-round are suitable only for the lightest types of general aviation aeroplanes. Their suitability depends on appropriate composition and good drainage characteristics of the subsurface. In an ideal case, such an aerodrome would be located on flat land, on a natural layer of gravel covered with approximately a 20 cm layer of topsoil. The surface should be covered with a grass carpet. The type of grass should be chosen so that the roots are sufficiently dense to create a thick and strong carpet in order to reinforce the soil surface. The majority of grasses used are slow growing and therefore do not require frequent mowing. It is unusual to find such an ideal interplay of all factors. The problem is an appropriate water supply. In spring, after a period of melting snow, and in autumn, after longer-lasting rains, the surface may be sodden and its bearing strength reduced. Even if artificial drainage is provided, it is hard to justify the use of non-reinforced grass aerodromes for a business activity because it is difficult to provide the required regularity of operation. In summer, in a period of dry weather and with an intensive operation, the grass carpet will be damaged, sometimes even destroying the roots.

8.2.2 Reinforced Grass Strips

In some cases, it is worth reinforcing a grass runway. During World War II, the Allies used steel grills to build temporary field aerodromes, interconnecting several fields with them. The same method of surface reinforcement is still in use in the army today, particularly for heavy equipment parking areas.

A modification of that principle consists in laying down netting made from synthetic fibres over the upper stratum of topsoil when the grass carpet is put in place. The netting helps to anchor the roots of individual grass tufts better. It carries part of the load and, at the same time, takes the friction load from braking of the aeroplanes' tyres. Alternatively, the same system used for

improving the runway strip bearing strength (see Chapter 5, section1) could also be used to increase the strength of the grass runway. The technology called ‘fibre-turf’ is based on a mixture of natural constituents and inert polymer fibres which guarantee a three-dimensional strength and stability of the grass rootzone. The polymer fibres reinforce and protect the natural turf.

In some cases it is necessary to increase the bearing strength of a runway but at the same time to maintain its grass surface. Such a pavement is often designed only for temporary use and later must be either returned to its original condition, or used in a different way for agricultural purposes, for example, aerodromes for agricultural operations or as a temporary general aviation airport. A runway may be temporarily reinforced with lime in its bearing layer. Attempts have been made to apply lime even in the upper layer of a pavement. The advantage of that method is its simplicity as well as the possibility of returning the pavement to agriculture by deep ploughing. Calcium is added to the earth either in the form of quicklime- CaO or calcium hydrate- $\text{Ca}(\text{OH})_2$. The cementing bonds among the particles of earth are reversible, that is to say, the stabilisation may be broken and made compact again when the bonds reconstitute in the earth. If it is necessary to drain the pavement, it is appropriate to use powdered lime with a high percentage of active CaO with excellent hydration ability.

Occasionally it might be required to increase the bearing strength of a runway with a grass surface by constructing the bottom layers in a similar way to those under pavements with an asphalt surface. Then a 15-20 cm layer of soil is spread on the sub-layer and a grass carpet is put on top.

8.2.3 Reinforced Pavements with Hard Surface

8.2.3.1 Use of hard surface pavements

In an aerodrome intended for a year-round regular operation of aeroplanes with mass greater than 2 000 kg in European climatic conditions, the use of a hard surface is essential. A choice of the pavement construction is influenced by many factors and the final design is often a compromise. It is possible to cater for even the heaviest aircraft with asphalt runways.

It is appropriate to use cement-concrete rigid pavements for some movement areas while, in other cases, asphalt-flexible pavements are useful. In general, the types of construction do not differ from constructions used in road building except in the required thickness, which is considerably greater in the aerodrome pavements designed for transport airplanes than in the roads as a consequence of larger point loads.

The construction of a reinforced pavement consists of subgrade, sub-base, bearing course and wearing course.

8.2.3.1.1 Subgrade

The area chosen for an aerodrome should have soil with suitable mechanical properties. The earth in the subgrade should have a sufficient bearing strength but at the same time it must be impermeable and its volume should not be affected by frost or changes in humidity. A soil analysis determines which kinds of soil need to be removed from the aerodrome pavement subgrade, which may be improved by adding different soil, and which soil and minerals in the aerodrome vicinity may be used in its construction.

The choice of type of pavement construction has a considerable effect on the bearing strength of the subgrade. In simple terms, the greater the bearing strength of the subgrade, the relatively thinner and cheaper may be the entire construction of the pavement. The type of pavement is affected also by the availability of suitable building material in the aerodrome vicinity. The choice of type of pavement is decided by an appraisal of life cycle costs, taking into account not only the costs of the pavement construction but also maintenance, and reconstruction of the runway system in a monitored time horizon, including an assessment of the losses due to closing the aerodrome during its repairs and reconstruction.

To declare the bearing strength of aerodrome pavements by means of the ACN-PCN method, it is necessary to know the subgrade bearing strength. For rigid pavements dimensioned according to Westergaard [8-A], the bearing strength is expressed by a modulus of reaction of the subgrade 'k'.

The modulus of reaction of the subgrade is the contact pressure that is required for pressing a standard loading plate into the subgrade. Either of two methods may be used:

- the loading plate is weighed down with a pressure $p = 0.07$ MPa and then depth 'z' is determined
- the plate is pressed into the depth of 1.27 mm and the contact stress is determined.

The modulus of reaction can then be determined by the relation:

$$k = \frac{P}{z} \left[MN.m^{-3} \right]$$

where:

- k modulus of reaction
- p contact stress $[N.m^{-2}]$
- z loading of the plate [m].

For flexible pavements, the subgrade bearing strength is expressed under the ACN-PCN method by the California Bearing Ratio (CBR). The CBR is the ratio of the tested material's bearing strength to the bearing strength of a standard sample of crushed stone, expressed as a percentage. It is determined in a special apparatus by loading tests in which a steel pin with diameter of 5 cm is pressed into the soil.

The dynamic modulus of elasticity (E) is determined by the method of damped impact to simulate running a wheel over the pavement. The effects are produced by a 100 kg weight falling onto rubber pad of prescribed hardness. The deflection of the plate is measured.

The finished and compacted subgrade may be covered with a geotextile which prevents contingent penetration of the subsoil stratum into the pavement construction. The bearing strength of the finished subgrade must be uniform.

8.2.3.1.2 Sub-base

The finished subgrade, which may be protected by a geotextile, is covered by a layer of gravel or crushed stone. That layer is supposed to fulfil a draining and filtration function. It drains the condensation created by temperature variations from the pavement construction and also catches any capillary water. The water is led away by means of catch-drains to collectors.

8.2.3.1.3 Bearing course

The role of a bearing course is to receive and distribute the pressures from the aeroplane undercarriage to an appropriately large area of sub-base and subgrade. The bearing course usually has several layers. The thickness and composition of individual strata depend on the subgrade bearing strength and on the construction of the wearing course. In order that the pavement may be designed economically, the upper layer should always have greater bearing strength than the layer under it. As a bearing course, it is possible to use clay or argilliferous stabilisation, cement stabilisation (gravel with fine fractions admixed with 8 to 10% of cement), macadam or gravel.

8.2.3.2 Flexible (asphalt) pavements

In the late 1970's the use of asphalt pavements became popular. They are now used for types of movement areas and loads for which in the past only cement-concrete pavements were used. At comparable costs, the asphalt pavements have several advantages. The construction of asphalt

pavements is less demanding

It is simpler and less expensive to carry out repairs and renovation on asphalt pavements. The reconstruction of asphalt pavements may be carried out even without interrupting operations if the works are performed by night. Asphalt pavements also withstand winter maintenance better when chemical de-icing materials are used. The asphalt pavements have the further advantage that their surface is even and without joints.

On the other hand, the asphalt pavements are less used in military aerodromes due to their reduced resistance against the impact of hot exhaust gases from military jet engines. Their resistance against spilt fuel is also lower.

The relatively lower bearing strength of asphalt pavements is due to the different manner of transmitting the load. With asphalt pavements, the load is transmitted by an interaction of individual material particles under the effect of physical bonds of asphalt. The bearing strength is limited to the load that causes a permanent deformation of the flexible asphalt layer.

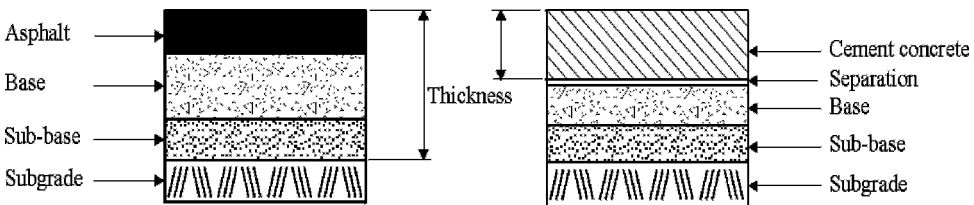

Figure 8-1 Typical construction of asphalt and cement concrete pavement
(Source: *Aerodrome Design Manual, Part 3, Pavements, ICAO Doc 9157-AN/901*)

The upper part of the asphalt pavement is usually composed of two asphalt layers which have different functions. A supporting asphalt layer containing coarse gravel fractions is put in place on the bearing course. Its role is to transmit the load on the bearing layers. Its thickness depends on the required resultant bearing strength, or when reconstruction is carried out, also on the condition and profile of the pavement underneath (Figure 8-1). Depending on the total thickness, which is usually within the range from 10 to 40 cm, the asphalt layer may be spread several times by a finisher in order that the required compactness can be obtained.

The upper wearing layer contains finer fractions of quality aggregate. The function of the wearing layer is to resist friction forces that are created by braking on landing, or during a rejected take-off and turning of the aeroplane. The pavement surface roughness is designed to ensure appropriate braking action. In order that the wearing layer can resist these forces, it should be at least 4 cm thick. Its second function is to create an impermeable surface. It must perfectly seal the entire

construction of the pavement. If water penetrates into the subgrade, it will gradually erode, lose bearing strength, and subsequently lead to rupture of the bearing courses. The wearing course also transmits the load to the layers underneath.

Besides other things, it is important to monitor the temperature of the asphalt composition during the construction. Maintenance of the prescribed temperature is a precondition of achieving the required compactness of the strata and the bonding of the strips. It is often at badly treated joints that ruptures appear.

When considering the bearing strength of the asphalt pavement, one of the decisive factors is the overall thickness 'h' of the pavement including the bearing course.

8.2.3.3 Rigid (cement-concrete) pavements

The main advantage of rigid pavements is their higher bearing strength which is derived, among other things, from different transmission of the load. The upper layer, a cement-concrete plate, rests on a semi-flexible subgrade. The rigidity of the cement-concrete plate depends on the quality of the mixture.

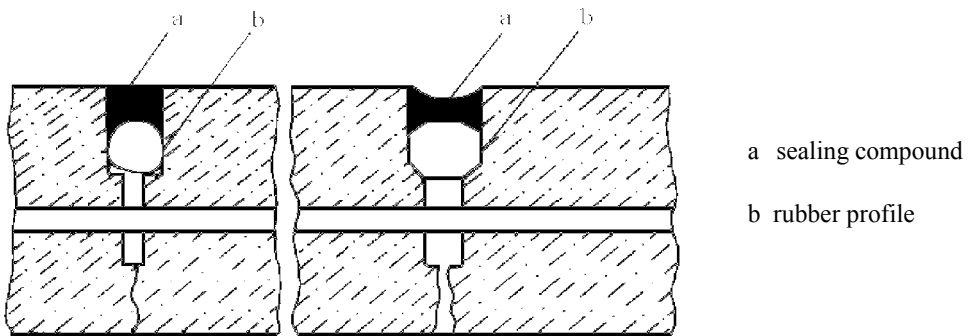

Figure 8-2 *Contraction joint*

The plate transmits the load to a considerably greater area. Inasmuch as the rigid wearing courses are not flexible enough to be able to follow even the slightest deformations of the subgrade, they only may be designed on a quality subgrade with an even bearing strength.

Another advantage is a longer design life of the cement-concrete plate. The design life of a rigid pavement on an appropriate subgrade and with proper maintenance may be 20 to 30 years.

A cement-concrete plate is usually made from plain concrete 20 to 30 cm thick. The thickness of the plate is limited by the possibilities of regular compacting of the concrete mixture and by the fact that, with an increasing thickness of the plate, the magnitude of the internal stress increases due to temperature variations causing differential expansion of the upper and the lower parts of the plate. The temperature gradient is about 0.5 °C per 1 cm. As a matter of fact, it is considerably greater in the upper part of the plate up to a depth of about 3 cm.

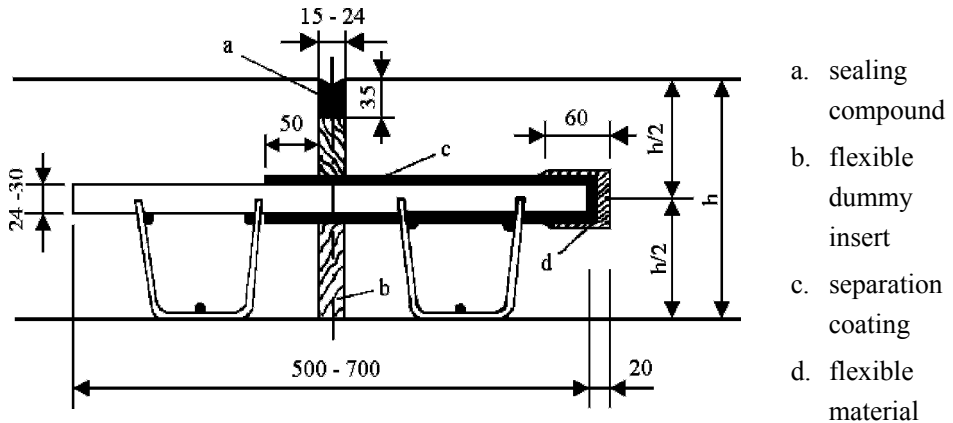

Figure 8-3 Expansion joint

The different expansion of the upper and the lower parts of the plate as a consequence of temperature variations manifests itself in a tendency to deform the cement-concrete plate into a convex or concave shape. The internal forces reduce the bearing strength of the plate in comparison with its normal condition and are taken into account during design. A sliding asphalt intermediate layer can be put in place on the subgrade, which allows the dilation of the cement-concrete plate.

The cement-concrete plate is laid by means of a finisher. On aerodromes, finishers are used that are capable of putting a 15 m wide or smaller plate in place. The treated and compacted concrete mixture behind the finisher has a smooth surface. Therefore the flaccid concrete mixture should be roughened generally with plastic brushes which are pulled perpendicularly to the longitudinal centre line of the runway.

In order to prevent the cement-concrete plate from developing irregular cracking under the effects of the internal stress at differential expansion of the upper and the lower parts of the plate, the concrete-cement strip should be divided by contraction and expansion joints into individual plates.



Figure 8-4 *Damaged sealing compound on a joint (Photo A. Kazda)*

The contraction joints (Figure 8-2) with a width of approximately 5 mm are cut in the hard-set concrete mixture to approximately 1/4 of the plate thickness. In the subsequent setting, as a consequence of the internal stresses, it will break under the incised joint. The contact surfaces are uneven with irregularities which anchor the neighbouring plates and provide them with a support. Thus the concrete strip is divided by the contraction joints into plates from 3 to 9 m long, depending on the pavement width, its thickness and quality of the concrete mixture.

The expansion joints divide the cement-concrete plate through its entire thickness and facilitate shrinking and expanding of the pavement. They are located at distances of approximately 40 m. The neighbouring plates on both sides of the expansion joint should be anchored. The manner of anchoring is illustrated in Figure 8-3.

The contraction and expansion joints should be perfectly sealed (Figure 8-4). If water penetrates and erodes the bearing courses and the subgrade, the concrete plate will lose its support and crack under load. The subsequent repair would be very expensive. The joints are sealed with different

types of rubber and then by a filler. The filler should perfectly adhere to the joint walls and must be permanently flexible. In winter during freezing it must not crack, and in summer with high temperatures it must not flow. The base of fillers consists of asphalt with additives of rubber and plasticizing agents.

Figure 8-5 Probability of transverse distribution of the aeroplane movements on the RWY

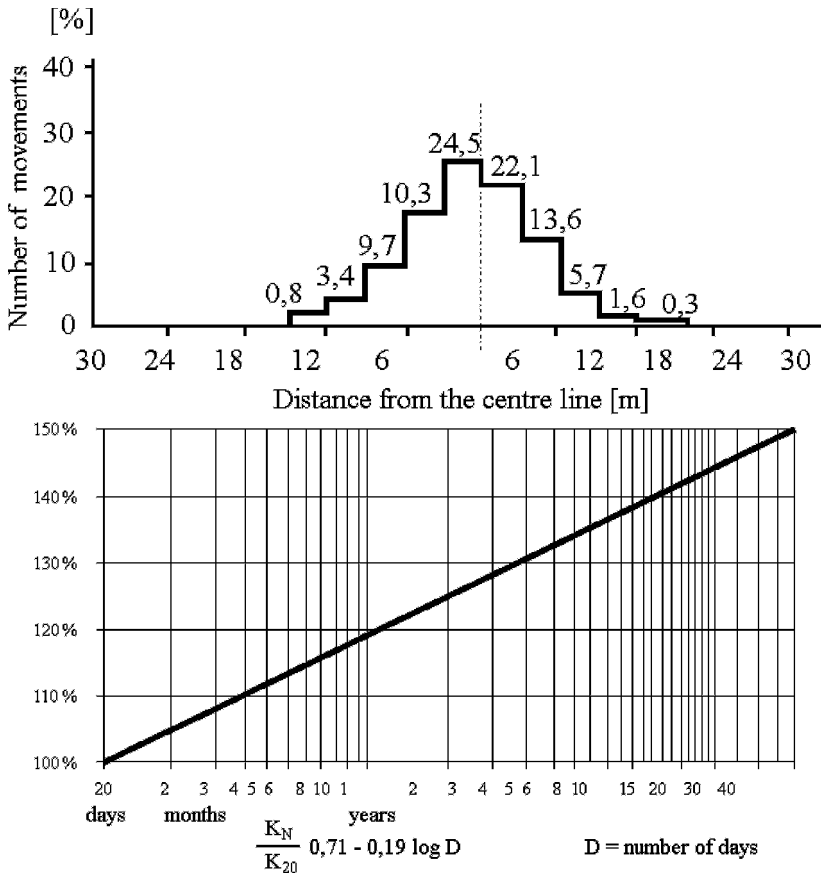

The quality of the concrete mixture must be controlled during the construction, samples being tested. The concrete will reach the required rigidity after 28 days (Figure 8-6). The pavement is dimensioned by the Westergaard method.

Figure 8-6 Increase of concrete strength with time

Aprons are critical points of the movement areas. There the aeroplane has its maximum mass. Similarly, the taxiways are highly stressed by a slowly moving aeroplane with the engines running.

It is often thought that the runway is stressed maximally in the touch down area.

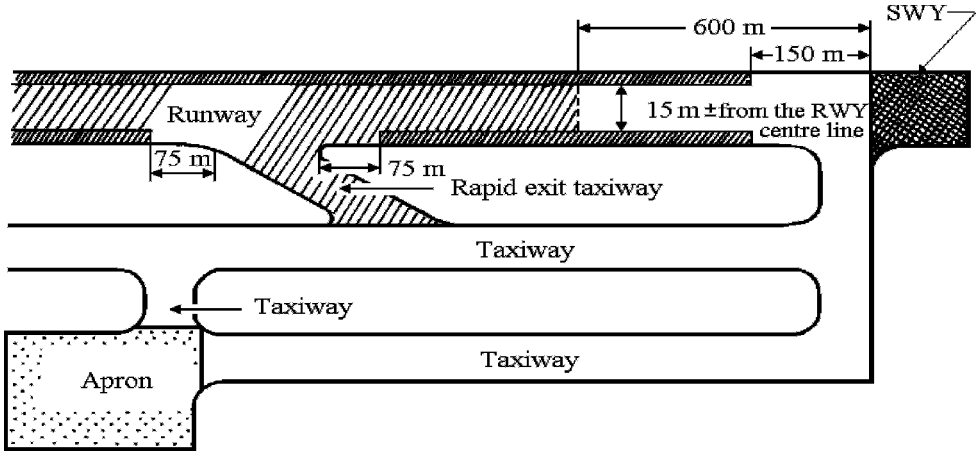

Figure 8-7 Optimizing pavement design – RWY equipped with a parallel TWY
 (Source: Aerodrome Design Manual, Part 3, Pavements, ICAO Doc 9157-AN/901)

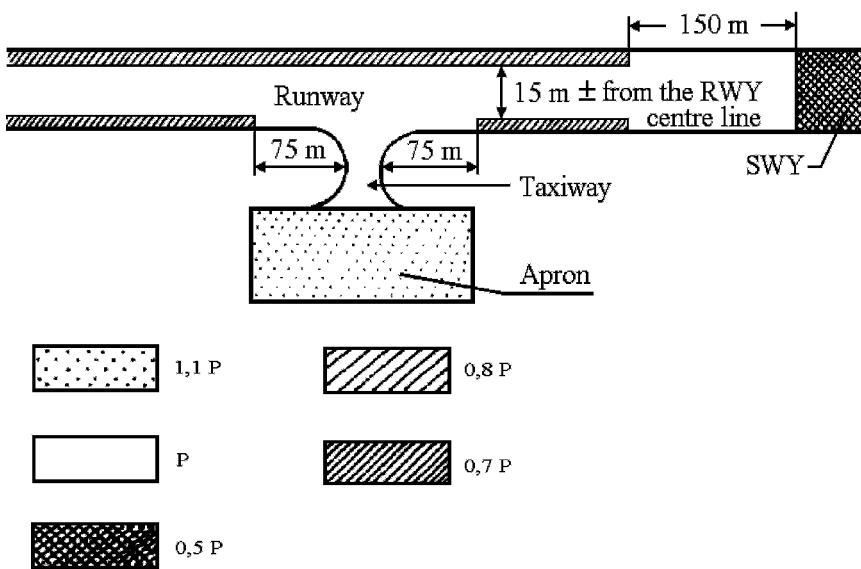

Figure 8-8 Optimizing pavement design – RWY not equipped with a parallel TWY
 (Source: Aerodrome Design Manual, Part 3, Pavements, ICAO Doc 9157-AN/901)

In fact, at touchdown, the aeroplane has still a lift from the wings so that the load seldom exceeds

40 per cent of the aeroplane maximum mass.

Taking into account the probability of transverse distribution of the aeroplane movements (Figure 8-5) on the runway, it is possible to dimension the maximum load only in the central part of the pavement (Figure 8-7 and 8-8).

As with other types of construction, the aerodrome pavement has a fatigue life. The pavement is designed, for example, for 10 000 movements of a given limit load. The rigidity declines as the pavement is used. As is apparent from Figure 8-9, after 10 000 repeated stresses, the tensile strength declines to almost half-value.

Figure 8-9 Effect of critical loads repetition on pavement tensile strength

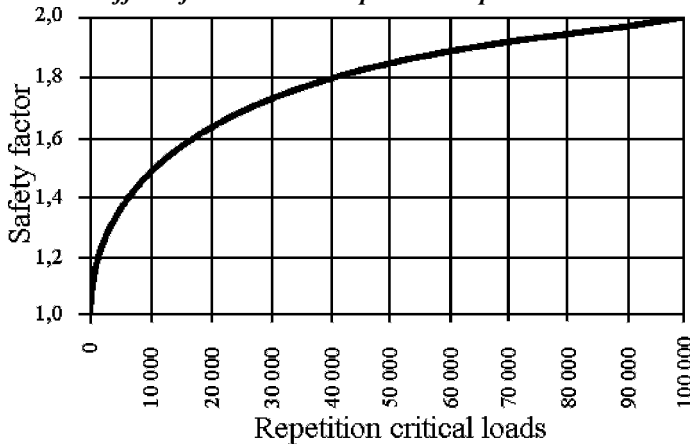

On the other hand the strength of the concrete increases with time as the concrete ages. That property of the concrete may to a certain degree reduce the impact of the stress from the repeated loads, particularly if the loads from larger aircraft only occur several years after completion of its construction. The degree of strengthening is dependent on the composition of the concrete mixture and its quality, the rate being illustrated in Figure 8-6.

The resultant characteristics of the cement-concrete plate, when evaluating the construction of the pavement in relation to the load characteristics of the aeroplane undercarriage, is expressed by the radius of its relative rigidity ‘I’ by the relation:

where:

$$I = \sqrt[4]{\frac{D}{k}} = \sqrt[4]{\frac{E \cdot h^3}{12(1-\mu^2)k}} \quad [m]$$

D bending rigidity of the plate $D = E \cdot h^3 / 12(1-\mu^2)$

- E Young's modulus of concrete elasticity in tension and compression [N.m^{-2}]
- h thickness of the cement-concrete plate [m]
- μ Poisson constant, usually $\mu = 0.15$ [non-dimensional]
- k modulus of cubic compressibility or 'modulus of subgrade reaction' (8.2.3.1.1) [N.m^{-3}].

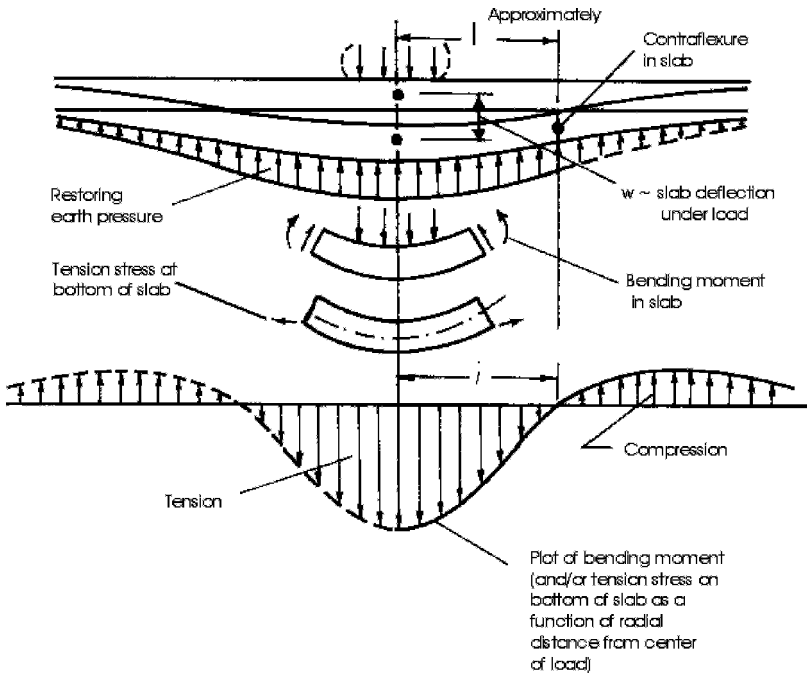

Figure 8-10 *Physical meaning of Westergaards 'radius of relative stiffness' l*
 (Source: *Aerodrome Design Manual, Part 3 Pavements, ICAO Doc 9157-AN/901*)

The radius of relative stiffness is graphically illustrated in Figure 8-10. The pavement bearing strength is influenced significantly by:

- quality of the concrete expressed in the modulus of concrete elasticity **E**
- thickness of the cement-concrete plate **h**
- quality of the subgrade characterised by 'modulus of subgrade reaction' **k**.

In practice the real bearing strength differs from theoretical values and is influenced by many factors. Therefore the real bearing strength in practice is determined by loading tests currently used in the building industry.

8.2.3.4 Combined pavements

There are often cases in practice where reconstruction of a rigid pavement is performed by laying a new cover of several layers of asphalt. This type of reconstruction has both advantages such as disadvantages which must always be assessed from case to case.

8.2.3.5 Block paving

For aprons, and parking areas in particular, the use of special paving has become more common. Rectangular paving bricks pressed from high-strength concrete of dimensions 100 mm x 200 mm by 80 mm thick are most common, but other shapes are used as well. The blocks are laid into coarse-grained and sharp sand. Finer sand is vibrated into the joints by which the blocks are fixed one to another. By mutual 'interlocking' of the blocks, the pavement transmits vertical loads on a considerably greater area.

In order that the fine sand does not blow out from the joints or that the bedding sand layer is not damaged if an oil spillage occurs, the block paving should be sealed. A liquid is used which, after being spread into the joints, polymerises and creates a permanently flexible sealing of the block paving.

The main advantages of the block paving are as follows:

- they may be laid even in winter in sub-zero temperatures
- they may be used by aircraft immediately on completion of laying
- maintenance of pavements is speedy and simple.

8.3 PAVEMENT STRENGTH

8.3.1 Pavements-Aircraft Loads

There is a general rule that the bearing strength of runways, taxiways and aprons should be capable of withstanding the maximum load derived from the aeroplane which the aerodrome may expect to serve. Such an aeroplane is called a critical aeroplane and the derived load is the critical load.

It is difficult to determine the bearing strength of non-reinforced grass areas. The bearing strength is dependent on the quality of the grass surface and the bearing strength of the soil. The bearing strength of the soil may vary very quickly, depending on the humidity. In practice, the capability of a grass area may be assessed visually, or even better, by repeated rides through the area in a car.

In this way it is possible to discover places with locally lower bearing strength. A greater measure of objectivity may be provided by means of a metal stick, with a scaled taper on the end. According to the depth the taper penetrates into the soil when the stick is dropped from a specified height, an approximate bearing strength of the grass surface may be determined.

The load an aeroplane applies to a pavement depends not only on the total mass of the aeroplane but also on other factors, in particular on:

- type of undercarriage
- number of wheels on the main undercarriage leg
- geometric configuration of the wheels in the undercarriage
- tyre pressure.

The critical loading is generated by the main undercarriage leg. In the simplest case, a main leg has only one wheel. Then it is possible to determine the load magnitude from the size of the contact area of the tyre with the pavement surface, the proportion of the aeroplane mass which is applied to one undercarriage leg and on tyre pressure:

$$A = Q/P_0$$

where:

- A contact area of tyre [m^2]
- Q load transmitted by the main undercarriage leg [N]
- P_0 tyre pressure p [Pa] multiplied by a contraction coefficient of the tyre m which expresses the resistance generated by its rigidity (values within the range from 1.03 to 1.1) $P_0 = pm$

The contact area has approximately the shape of an ellipse.

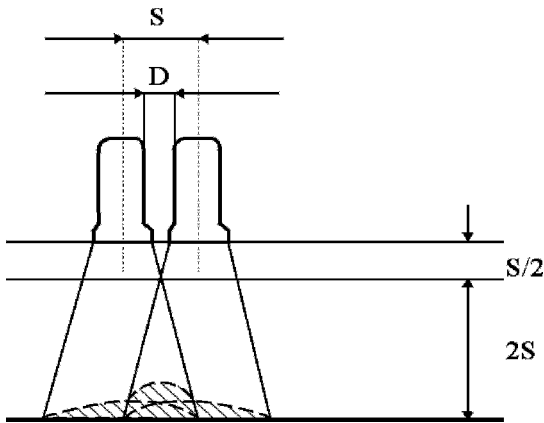

A more complicated event occurs if the main undercarriage leg has two, four, or more wheels. Then the loading generated by individual wheels must be partially summed, depending on the distance of one wheel from another, as well as on the pavement properties. The manner of summing the loads is schematically illustrated in the Figure 8-11.

Figure 8-11 *Scheme of load distribution from dual wheel undercarriage in the pavement layers*

At the same time it is apparent from Figure 8-10 that the resultant load is dependent on the pavement construction thickness. With a more detailed analysis it is possible to determine also the dependence on the quality of individual courses of the pavement.

The effect of a multi-wheel undercarriage is expressed by the Equivalent Single Isolated Wheel Load. This is the theoretical load generated by a single wheel which generates the same effects in the pavement as a real multi-wheel undercarriage. The tyre pressure is the same in the two cases.

8.3.2 Pavement Strength Reporting

The information on the bearing strength of an aerodrome pavement is necessary:

- to ensure the integrity of the pavement to its optimum design life
- to determine the types of aircraft that may use the pavement and their maximum operational masses
- to design the aircraft undercarriage so that it may be used in the majority of the current aerodromes.

Annex 14, Volume I, Chapter 2 prescribes the consistent manner in which the bearing strength of movement areas is to be reported, thus encouraging its world-wide standardisation. This method includes two procedures.

The first procedure is related to the pavements intended for aircraft up to maximum mass of 5 700 kg. The bearing strength is determined by maximum allowable mass and maximum tire pressure, see Table 8-2.

Table 8-2 Reporting of the bearing strength of a pavement intended for aircraft of apron mass equal or less than 5 700 kg



The second procedure is called ACN-PCN (Aircraft Classification Number - Pavement Classification Number).

ACN is the number indicating the relative effect of an aeroplane on the pavement resting on any of four types of subgrade of standard quality.

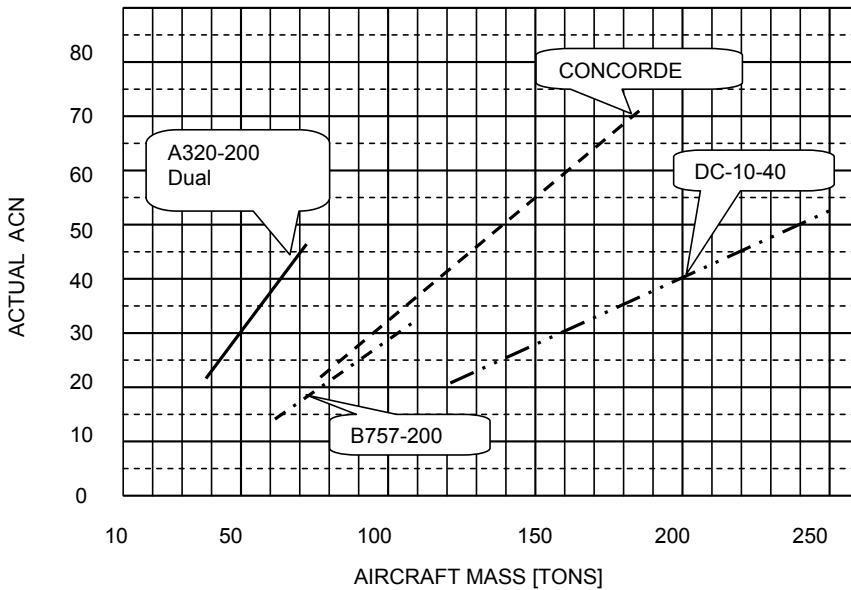

Figure 8-12 Range of ACN and MTOM/ OEM values for some airplanes; rigid pavement; $k = 80 \text{ MN/m}^3$, (relevant data are shaded in the Table 8-3) (Source: aircraft manuals)

PCN is the number indicating the bearing strength of a pavement with an unlimited number of aircraft movements.

Table 8-3 ACNs for several aircraft types

Aircraft type	All-up mass [kg]	Load on one main gear leg [%]	Tyre pressure [MPa]	ACN for rigid pavement subgrades [MN/m ³]				ACN for Flexible pavement subgrades [CBR]			
				High 150	Medium 80	Low 40	Ultra low 20	High 15	Medium 10	Low 6	Very low 3
(1)	(2)	(3)	(4)	(5)	(6)	(7)	(8)	(9)	(10)	(11)	(12)
DC-8-55	148 778	47.0	1.30	45	53	62	69	46	53	63	78
	62716			15	16	19	22	15	16	18	24
DC-8-61/71	160 121	46.5	1.29	47	56	65	73	49	56	67	83
	65 025			15	16	19	22	16	16	18	24
DC-8-62/72	162 386	47.6	1.34	50	60	69	78	52	59	71	87
	72 002			17	19	23	26	18	19	22	29
DC-9-15	41 504	46.2	0.90	23	25	26	28	21	22	26	28
	22 300			11	12	13	14	10	11	12	14
DC-9-21	45 813	47.15	0.98	27	29	30	32	24	26	29	32
	23 879			12	13	14	15	11	12	13	15
DC-9-2	49 442	46.2	1.05	29	31	33	34	26	28	31	34
	25 789			14	15	15	16	12	13	14	16
DC-9-41	52 163	46.65	1.10	32	34	35	37	28	30	33	37
	27 821			15	16	17	18	13	14	15	18
DC-9-51	55 338	47	1.17	35	37	39	40	31	32	36	39
	29 336			17	17	18	19	15	15	16	19
DC-10-40	253 105	37.7	1.17	44	53	64	75	53	59	70	97
	120 742			20	21	24	28	22	23	25	32
A 320-200 Dual	73 500	47.0	1.45	44	46	48	50	38	40	44	50
	39 748			20	22	23	25	19	19	20	24
Concorde	185 066	48.00	1.26	61	71	82	91	65	72	81	98
	78 698			21	22	25	29	21	22	26	32
DHC 7 DASH 7	19 867	46.75	0.74	11	12	13	13	10	11	12	14
	11 793			6	6	7	7	5	6	6	8
B 757-200	109 316	45.2	1.17	27	32	38	44	29	32	39	52
	60 260			12	14	17	19	14	14	17	22

Source: Aerodrome Design Manual, Part 3 Pavements, ICAO Doc 9157-AN/901

The ACN-PCN method expresses the bearing strength of a pavement in whole numbers between zero and an unspecified maximum. The same scale is used for expressing the load characteristics of aeroplanes. A single wheel with a weight of 500 kg and tire pressure of 1.25 MPa represents a load of 1 ACN. The bearing strength of a pavement with a bearing strength that just corresponds to that load registers 1 PCN. In other words, a PCN for an unlimited number of movements should

be equal or higher than the ACN.

The ACN-PCN method is a very simple method of reporting pavement strength from an operational viewpoint. It does, however, require the ACN of individual aeroplanes to be published. The ACN-PCN is not intended for designing pavements, neither does it determine a method by which the bearing strength of a pavement should be specified. On the contrary, an airport operator may use an arbitrary method for PCN determination.

The ACN of an aeroplane is determined by means of two mathematical models. One of them is applicable for rigid, the other for flexible pavements.

Table 8-4 Reporting of the bearing strength of a pavement intended for aircraft of apron mass greater than 5 700 kg

PNC	Pavement classification number	Code	Pavement type	Code	Subgrade strength category	Code	Tyre pressure	Code	Evaluation method
	Bearing strength without limitation of a/c movements	R	Rigid	A	High K=150MN.m ⁻³ CBR = 15 %	W	High (no pressure limit)	T	Technical evaluation
		F	Flexible	B	Medium K=80 MN.m ⁻³ CBR = 10%	X	Medium up to 1.50MPa	U	Using aircraft experience
				C	Low K=40 MN.m ⁻³ CBR = 6%	Y	Low up to 1.00 MPa		
				D	Ultra low K=20 MN.m ⁻³ CBR = 3 %	Z	Very low up to 0.50 MPa		

A computer programme was elaborated by the Portland Cement Association of the USA and was provided to ICAO to determine the ACN of the majority of aeroplanes in service. The ACN values are given in an Aerodrome Design Manual, Part 3, Pavements. Similarly, in the case of new types of aeroplanes, ICAO may determine ACN for the given type of aeroplane based on the data provided.

For calculation of the actual ACN for arbitrary mass between the maximum and empty mass of an aeroplane, a linear function is applied (Figure 8-12). An overview of the ACN-PCN method of data coding is given in the Table 8-4.

To find for example the actual ACN of an Airbus A 320-200 Dual with a mass of 60,500 kg on a flexible pavement resisting on a medium strength subgrade (CBR – 10%) and with a tyre pressure 1.45 MPa the following formula could be used:

$$ACN = ACN_{MAX} - \frac{(MTOM - AOM)}{(MTOM - OEM)} \times (ACN_{MAX} - ACN_{EMPTY})$$

where:

ACN_{MAX} ACN for the maximum take-off mass

MTOM maximum take-off mass

AOM actual operating mass

OEM operating empty mass

ACN_{EMPTY} ACN for the operating empty mass

$$ACN = 40 - \frac{(73500 - 60500)}{(73500 - 39748)} \times (40 - 19)$$

$$ACN = 32$$

Note: ACN must be always a whole number.

The ACN-PCN method publishes the required data in the form of a code. The data are given for two different types of pavements, rigid R, and flexible F, for eight standard categories of subgrade (four values of k for rigid pavements and four values of CBR for flexible ones). Then the system uses four categories of tyre pressure. The code contains also information on the method of determining PCN. When PCN is determined on the basis of operational experience, according to the ACN of the critical aeroplane, a U (Using Aircraft Experience) code is used. If PCN is determined by any of the more sophisticated methods used in civil engineering, a T code (Technical Evaluation) is used. Table 8-3 gives data of several types of aeroplanes as they are published by ICAO.

8.3.3 Overload Operations

Under certain conditions, the pavement can bear even greater load than that calculated. When it is overloaded, it does not break up suddenly. Loads which are larger than the defined loads shorten the design life of the pavement, whilst smaller loads extend it. Overloading of pavements can result from loads being too large, or from a substantially increased number of movements. With the exception of massive overloading, pavements are not subject to a particular limiting load when

under static loading. Their behaviour is such that a pavement can sustain a definable load for an expected number of repetitions during its design life. Occasional minor overloading only results in limited loss in pavement life expectancy. Therefore, for such cases, the following criteria are suggested:

- ➔ For flexible pavements, occasional movements by aircraft with ACN not exceeding 10 per cent above the reported PCN should not adversely affect the pavement.
- ➔ For rigid or composite pavements, in which a cement-concrete plate provides the crucial transmission of the load, occasional movements by aircraft with ACN not exceeding 5 per cent above the reported PCN should not adversely affect the pavement.

If the pavement structure is unknown, the 5 per cent limitation should apply. The annual number of overload movements should not exceed 5 per cent of the total annual aircraft movements. Such overload should not be permitted on pavements that are damaged or exhibit other signs of distress, or after strong freezing, or in cases when the bearing strength of the pavement or its subgrade could be weakened by water.

8.4 RUNWAY SURFACE

8.4.1 Runway Surface Quality Requirements

The runway surface quality requirements have gradually increased with implementation of ever heavier jet aeroplanes and the increasing speed of aeroplane movements on runways. The runway surface must not show unevenness sufficient to cause a loss of braking action, it must provide good braking action even when the surface is wet and should be cleaned of any foreign objects which might damage the engine. Annex 14, Volume I, Chapter 3 describes in detail the standards which specify the particular physical characteristics of the surface.

The smoothness of the runway surface is defined by several standards, which complement one another. The basic requirement for cement-concrete pavements is a test with a 4 m long board under which no unevenness larger than 5 mm may appear with the exception of drainage channels. In order that an adequate smoothness of the surface can be ensured, it is necessary to choose the appropriate types of inset lights, back-inlet gulleys and the like.

The manual detection of unevenness by means of a 4 m long board is lengthy, time consuming and rather inaccurate. An 'automatic' board, or Viagraf, equipment with automatic registration of unevenness (Figure 8-13) is often used instead. However, it can only register unevenness up to a length of approximately 2 m.

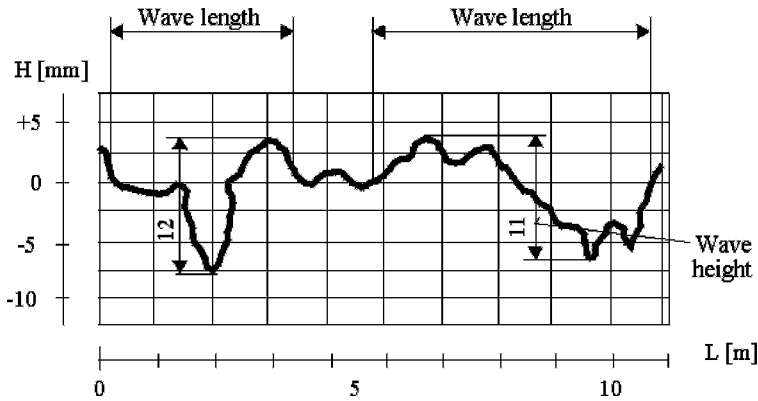

Figure 8-13 Surface unevenness diagram

(Source: Čihař, J.: *Letiště a jejich zařízení I*, Alfa Bratislava 1973)

8.4.2 Methods of Runway Surface Unevenness Assessment by the Dual Mass Method

At higher speeds of aeroplane movement on the runway, unevenness with small wave lengths loses its effect, and unevenness with wave lengths of the order of tens of meters acquires importance (Figure 8-14). That unevenness may be detected by means of a precise survey which is carried out after construction or reconstruction of the runway. Thus the supplier generally proves that the construction of the pavement complies with the respective standards within the permitted tolerances. However, once the aerodrome is in operation, it is impractical to make exact surveys of the runway. It is too expensive and time-consuming.

From the operational viewpoint, it is essential to know whether some unevenness complies or not with a certain constructional standard. For example, transversal grooving of the runway represents unevenness that does not conform to the standard 4 m board. However, not only does the grooving not impede the aeroplane's operation but it generally increases the coefficient of the pavement longitudinal friction and improves the braking action.

Therefore the conclusive criterion should be the effect of the pavement on the aeroplane that is moving on the runway at a certain speed. The condition of the pavement will have been gradually deteriorating since commissioning. Differential settlement of the subgrade, the effect of the operation of aeroplanes, breakdowns of the pavement and their repairs all progressively worsen the pavement unevenness. Small deviations from the specified tolerances have no substantial effect on the operation, but above some critical level, unevenness of the runway surface will endanger the

safety of the aeroplane during take-off or landing.

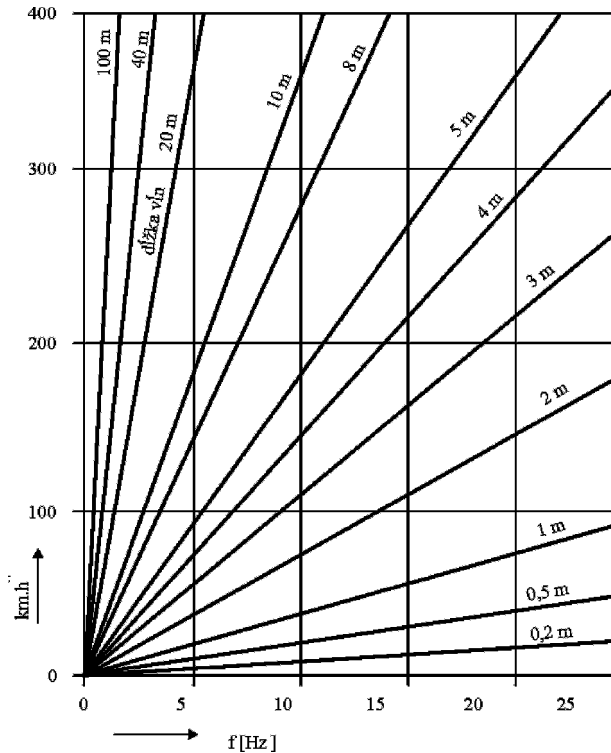

Figure 8-14 Relationship of oscillation frequency of the undercarriage wheel and speed of movement of the aeroplane on the runway

(Source: Čihař, J.: *Letiště a jejich zařízení I.*, Alfa Bratislava 1973)

Unevenness up to approximately 3 cm over a distance of 50 m is considered acceptable. However it must always be judged in relation to the type of operation on the runway, and in particular, to the speed of the aeroplane on the runway. The frequency of oscillation of the undercarriage wheel depends on the speed of movement of the aeroplane on the runway at the given length of unevenness. It can be expressed by:

$$f = v/\lambda \text{ [s}^{-1}\text{]}$$

where:

- f frequency of oscillation of the undercarriage wheel
- v speed of movement of the aeroplane on the runway
- λ length of the wave in the pavement

An oscillation with a frequency of more than 20 Hz is not significant because it is damped by dampers. Similarly, an oscillation less than 1 Hz is not dangerous because it develops only small vertical acceleration. The oscillation frequencies between 2 and 10 Hz are particularly dangerous. The measurement and evaluation of unevenness of the runway surface can be performed by means of a truck pulled behind a car (first mass) and an accelerometer (second mass) located on the truck which reacts to the surface unevenness. Permanent contact of the system with the surface must be ensured. The DM Method is based on the use of the theory of accidental functions. The unevenness of a length of wave up of 100 m may be measured (Figure 8-14).

The chosen speed of movement of the measuring system may be from 5 to 40 m.s⁻¹, (i.e. from 18 to 144 km.h⁻¹). The equipment measures the vertical acceleration and provides information on the spectrum of the wave lengths (from 2.7 to 100 m) Figure 8-15. The measurement should be carried out on a portion 500 m long as a minimum which is homogeneous from the viewpoint of the kind of covering, treatment and surface condition.

The basic statistical characteristic of the vertical unevenness is its scatter. Information on the intensity with which it occurs within the entire scatter of unevenness of particular wave lengths is given by the power spectral density of unevenness.

When an assessment is made of the dynamic response to the aeroplane moving on the runway, the following three factors should be assessed:

- impact of unevenness on the crew
- impact of unevenness on the passengers
- impact of unevenness on the aeroplane construction from the viewpoint of the strength and fatigue stress and from the viewpoint of the aircraft's controllability and the safety of its movement on the runway.

Other assessment criteria of the DM Method are the parameter C and zone classification included in the standard. The parameters determined by the DM Method are not mutually compatible with the results obtained by other methods.

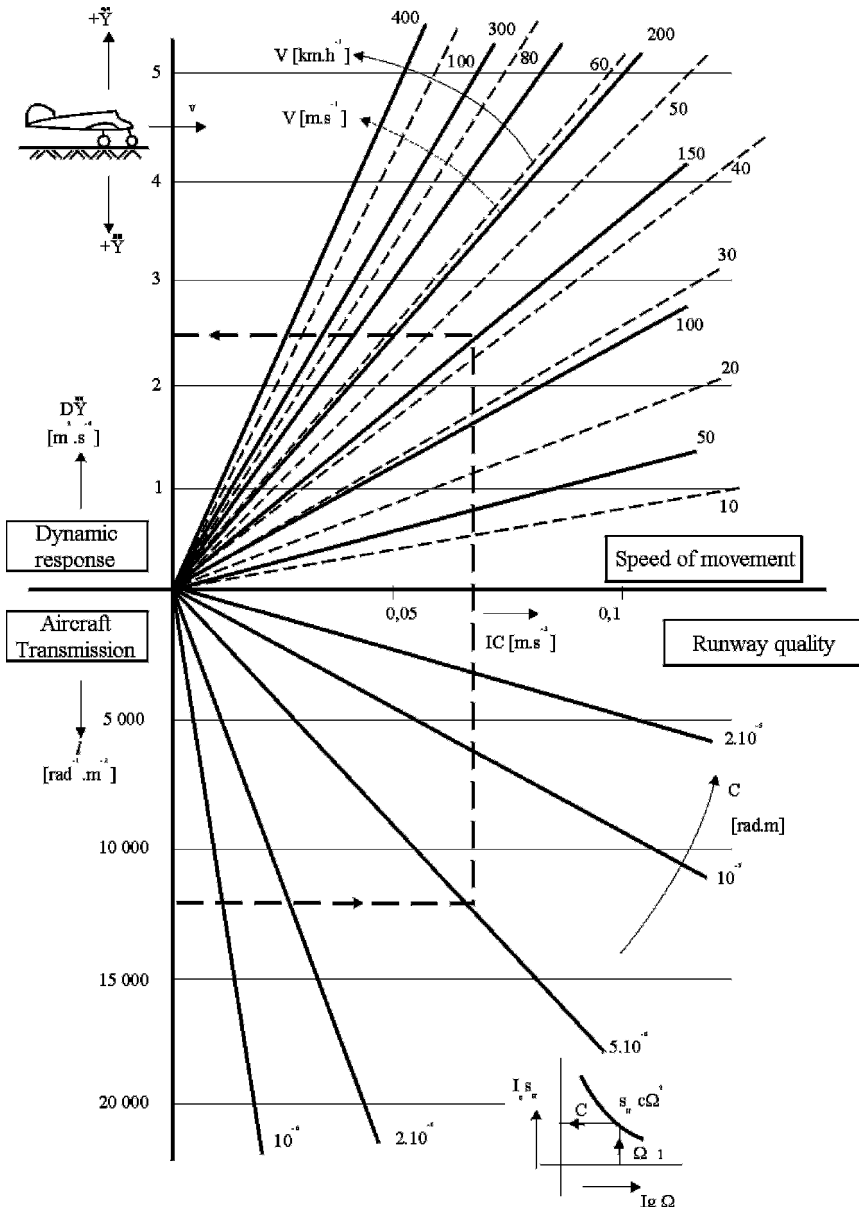

Figure 8-15 Dynamic response of aircraft vertical acceleration on different pavement quality (Source: Čihař, J.: Letiště a jejich zařízení I., Alfa Bratislava 1973)

where: $D\ddot{Y}$ square of acceleration [m²s⁻⁴]
 IC variation of acceleration [m³s⁻³]

8.4.3 Pavement Texture

The pavement surface should have specific antiskid properties, the properties being given by its micro-texture and macro-texture.

If the pavement is clean and dry, it generally has a good coefficient of longitudinal friction whatever the kind of surface (asphalt or concrete-cement pavement) or its drainage characteristics (pavement slope). In addition, the coefficient of friction of a dry pavement only changes very slightly with an increase of the aeroplane speed.

Whenever water in any quantity is present on a runway, the situation changes considerably. The coefficient of friction then depends substantially on the quality of pavement surface in terms of the surface texture and drainage characteristics of the pavement, particularly any tendency to pooling of water. At high aircraft speeds the coefficient of friction may drop considerably as a consequence of aquaplaning. Even so, the pavement must have a good coefficient of friction even when wet in order that the safety of aircraft operations is not endangered. The coefficient of longitudinal friction of the pavement depends on the following:

- ➔ macro-texture created by the binding of individual gravel fractions in the mixture, this controlling contact between the tyre and the pavement surface
- ➔ micro-texture characterised by the surface roughness of the grains of aggregates or mortar. Micro-texture is important for the so called 'dry contact' of a tyre on a wet pavement.

The macro-texture of a pavement is supposed to ensure good water drainage from the area in contact with the tyre. Therefore it is particularly important at high aircraft speeds. Macro-texture of a common road pavement is smoother, while that of an aerodrome pavement is more open. This is due to different drainage characteristics of car and aeroplane tyres, and the higher speeds that are reached by aeroplanes on a runway. A correct macro-texture may be obtained in a concrete surface as well as in an asphalt pavement surface. In cement-concrete pavements it is obtained by transversal brushing of the setting concrete. In asphalt pavements it is achieved by using correct fractions of the aggregates in the wearing layer and the correct procedure in laying the pavement.

The micro-texture of a pavement is formed by fine, but sharp irregularities on the grain surface which are capable of penetrating through the thin viscous film of water between the tyre and the pavement. It provides a contact with the tyre even at higher speeds. The micro-texture is created by the 'micro-roughness' of the individual surface particles. It is difficult to discern with the naked eye, but is discernible by touch. Therefore only quality, hard and rough aggregates should be used in the pavement wearing layer. The effect of the macro-texture and micro-texture on the coefficient of longitudinal friction depends on the aeroplane speed as illustrated in the Figure 8-16.

The greatest problem of the micro-texture is the fact that it may change in a relatively short time. A typical example is rubberising of the runway in the touch-down zone. The rubber deposits may cover the micro-texture without any change of macro-texture. As a result there is a substantial reduction of the coefficient of longitudinal friction when the pavement is wet.

While the macro-texture is characterised by its depth h_s , no objective criterion has been specified to determine the micro-texture. Based on experience it may be stated that the individual particles must be rough and have sharp edges. It is indirectly assessed by the coefficient of longitudinal friction.

At the time of construction the roughness should be optimum. The antiskid properties of the pavement surface can be determined by two methods:

- determining the depth of the macro-texture by means of sand
- determining the coefficient of longitudinal friction by means of a dynamometer.

The sand method is generally used during commissioning, while the dynamometer method is used for assessing the operational capability of the surface.

In the sand method, an average depth of the potholes is calculated from the surface of a circle in which all the unevenness is filled with an exactly determined quantity of sand. For the trials, 90 in their entirety, the sand of a specified granularity is used on the whole runway, dried at a temperature of 105°C and sealed in PVC bags each with 0.25 dm³. The depth of macro-texture h_s for 90% of all measurements should comply with the condition $h_s \geq 0.8$ mm.

In the dynamometer method the coefficient of longitudinal friction is calculated from the force required for pulling the braked measuring wheel on a wet pavement surface. The friction ought to be determined:

- on a periodical basis on a runway where the code number is 3 or 4 for calibration
- on a runway which is slippery when wet
- on a runway which has bad drainage characteristics.

The calibration measurement should be performed in good meteorological conditions on a dry and clean runway. In order to ensure homogenous conditions, the measuring device must be provided with self-wetting equipment. Thus the measurement is effectively carried out on a wet surface. The runway surface is wetted before measuring, and the quantity of water should be the same at all speeds. The measuring is performed with a braked wheel (100 per cent slip) at the speeds of 20, 40, 60, 80 and 100 km.h⁻¹, sometimes up to 135 km.h⁻¹.

The intervals of measurements should be determined as a function of the type of aircraft, the number of movements, the type of pavement and its maintenance, climatic conditions, etc.





SURFACE			APROXIMATE TRENDS IN MAXIMUM TYRE-GROUND COEFFICIENT OF FRICTION FOR SMOOTH TREAD TYRE
No.	MACRO-TEXTURE	MICRO-TEXTURE	
I	OPEN macro-textured surfaces provide good bulk drainage of tyre-ground contact area. In wet condition μ decrease gradually with increase in V .	 <p>HARSH micro-tured surfaces permit substantial penetration of thin fluid films; general level of friction is high.</p>	
II	Tread grooves have little effect. At high speeds μ may increase due to hysteresis effects.	 <p>SMOOTH or POLISHED micro-textured surfaces have poor thin-film penetration properties and a generally low level of friction results.</p>	
III	CLOSED macro-textured surfaces give poor contact area drainage. In wet conditions μ decreases rapidly with increase in V .	 <p>HARSH micro-textured surfaces permit substantial penetration of thin fluid films; general level of friction is high.</p>	
IV	Tread grooves are most effective on this type of surface.	 <p>SMOOTH or POLISHED micro-textured surfaces have poor thin-film penetration properties and a generally low level of friction results.</p>	

Figure 8-16 Effect of surface texture on tyre-surface coefficient of friction
 (Source: Aerodrome Design Manual, Part 3, Pavements, ICAO Doc 9157-AN/901)

If there is any suspicion that the braking characteristics may be impaired because the runway has a transverse slope or other inconvenient drainage characteristics, an additional measurement should be carried out when it is actually raining.

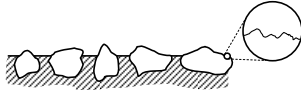
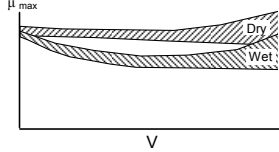
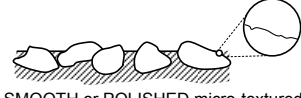
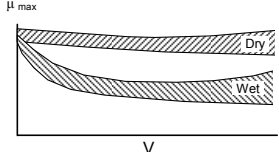
The measurements are performed with special vehicles, e.g. Saab Friction Tester, or by dynamometric trailers pulled behind a car, e.g. μ -meter. Each of these use different principles of measurement of the coefficient of longitudinal friction.

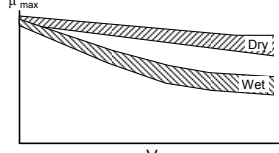
8.4.4 Runway Braking Action

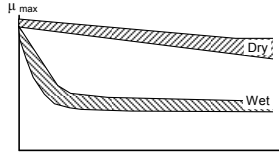
The braking action is connected with the antiskid properties of the runway surface. Whilst the macro and micro-textures are the characteristics of the pavement surface monitored during commissioning, the braking action is an operational characteristic of the pavement surface.

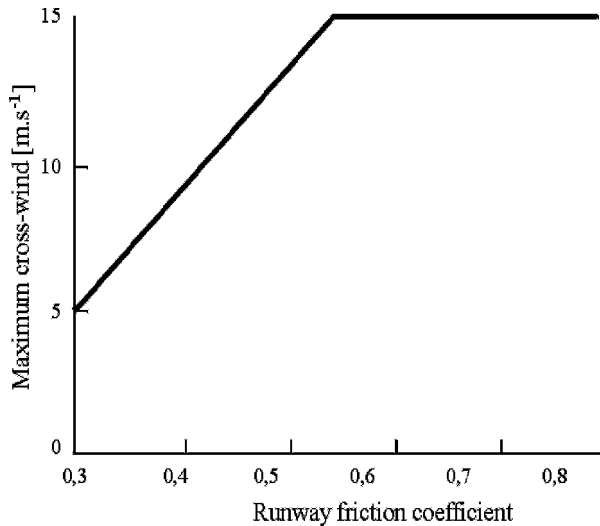

Figure 8-17 Relationship of runway friction coefficient and the crosswind

The braking action is influenced by:

- speed of the aeroplane on the runway
- design of the aeroplane
- design of the brakes
- type of automated antilocking device
- dimensions and number of tyres
- tyre tread pattern and wear
- aeroplane mass
- meteorological conditions
- as well as the coefficient of longitudinal friction on the runway surface.

Whilst the friction coefficient of a given pavement decreases slowly over several years, the braking action may change from minute to minute. Determination of the braking action is a part of the

runway daily checks to assess the operational capability. The checks should be carried out by the airport operator. Besides the frequent periodical inspections, additional checks should be performed, e.g. each time the climatic condition changes. The results should be reported to Air Traffic Control. Research suggests that 5 minute rainstorms create the most critical drainage challenge. Since the braking action is affected by many factors, it is important to understand what is happening in the contact surface between the tyre and the pavement surface.

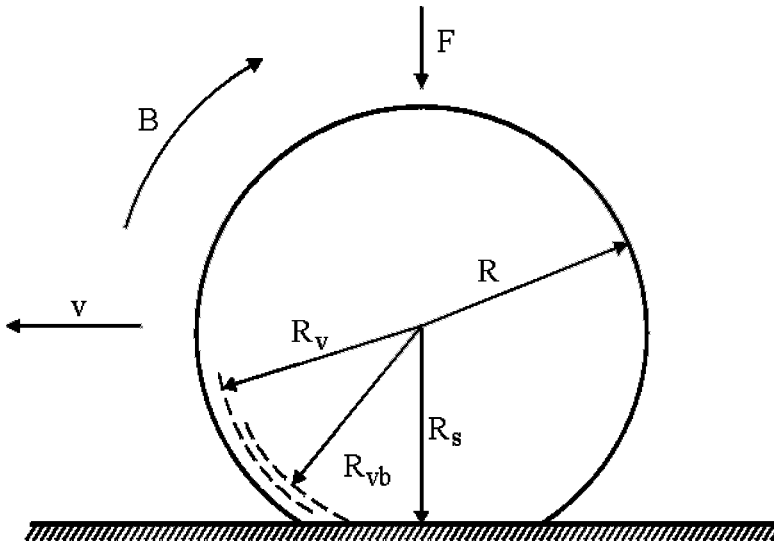

Figure 8-18 Relative slippage of the wheel – parameters

In the contact between the tyre and the runway surface, a footprint is created. Its size depends on the radial load and the tyre dimensions. When the tyre is loaded only by a radial force, the elementary forces in the contact area are in static equilibrium. If a force other than the radial one begins to exert its influence on the wheel, i.e. if the wheel begins to transmit peripheral or lateral force due to braking or cross wind, the distribution of the elementary forces in the tyre footprint will change (Figure 8-17). The resultant force in the contact area of the tyre is called a force of adhesion. The force bond between the tyre and the runway surface is determined by the adhesion. Therefore it is important from the viewpoint of the air operation safety to create good adhesion conditions.

Another important characteristic is the wheel slip. An absolutely rigid wheel would roll on the support on a radius R (Figure 8-18.). If a real wheel with a tyre is loaded, it will deform. The radius from the centre of the wheel to the footprint will diminish to a static radius R_s . When the

wheel is rolled on a pavement, a fictitious radius called a rolling radius R_v may be considered. It is the radius of a perfectly rigid wheel whose peripheral velocity and rolling velocity are the same as the peripheral velocity and rolling velocity of a real tyre. Here $R > R_v > R_s$ applies. From the comparison R and R_v , the so called relative slippage of the wheel may be determined.

If we load the wheel with an additional tangential braking force, it will deform further, and the wheel will roll on the radius R_{vb} , generating another tangential slippage. The following applies for the assessment of a relative slippage:

$$S = \frac{R_v - R_{vb}}{R_v} \cdot 100 \quad [\%]$$

where:

S relative slippage [m]

R_v rolling radius of the tyre in free rolling [m]

R_{vb} rolling radius of the tyre when loaded with braking torque [m].

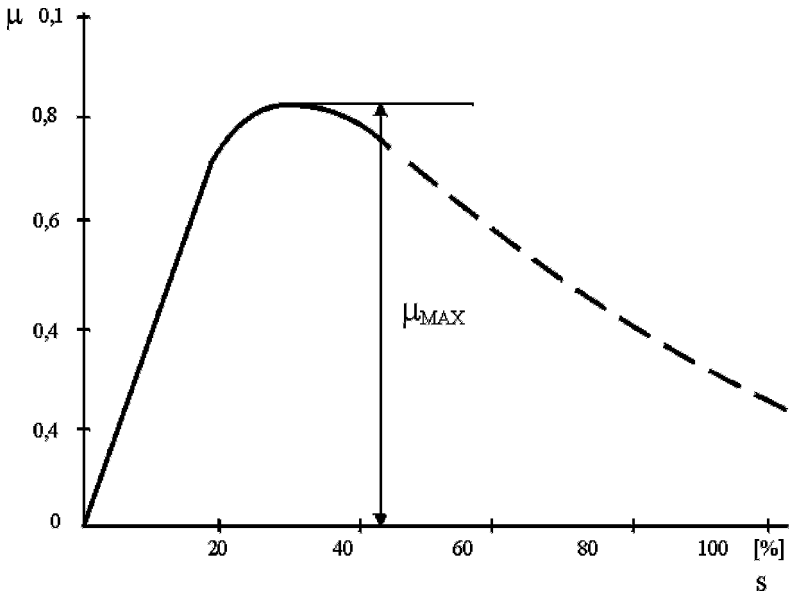

Figure 8-19 Relationship between percentage of slip and friction coefficient

It must be emphasised that the relation applies for a relative slippage, that is to say while the wheel is turning rather than being locked up.

In free rolling the relative slippage is zero. The relationship between the force of adhesion and the slip determines the most efficient manner of braking. The relationship is of the general form shown in Figure 8-19.

The maximum adhesion occurs with modern aeroplanes between 15 and 30% of slippage, and the brake antilocking systems are generally adjusted to that value. The shape of the slip characteristic depends on the runway surface condition. If the runway is covered with water, snow or ice, the relationship is rather more abrupt, and the maximum adhesion occurs at higher slip values.

The braking action may be determined in several ways:

- by estimation
- by measuring the distance or time required for the vehicle to come to a full stop.
- by braking the vehicle equipped with an accelerometer
- by special devices for continual measurement (Skiddometer, Surface Friction Tester, Mu-meter, Runway Friction Tester, GRIPTESTER).

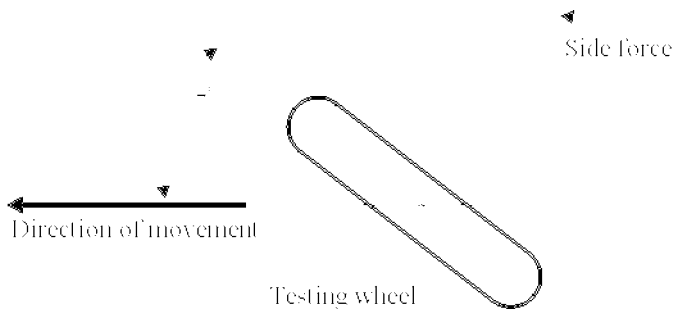

Figure 8-20 The principle of measuring friction coefficient by Mu-meter

The data obtained from the measurements carried out by particular devices cannot be used directly to quote a braking action. In order that the braking action can be reported, operational experience is also needed to interpret them.

When the braking action is determined on the basis of measurement of the distance or time required for complete stoppage of the braked vehicle, the testing vehicle is accelerated to a specified speed. The vehicle is usually occupied by two persons. At a chosen moment, the driver locks the brakes, giving 100 per cent slip. Therefore the data obtained by that method are worse than the real conditions and it creates the necessary safety margin.

The deceleration meter may only be used under certain conditions, e.g. on a runway covered with compacted snow, ice or a very thin layer of dry snow. The deceleration meter or a braked vehicle should not be used when the runway surface covering is not continuous. Reliable reporting of the braking action may be obtained from those devices that measure friction at high speed. They each function on different principles.

The Mu-meter (skid meter) evaluates a braking coefficient from the value of lateral force of the tested wheel mounted under an angle of 7° towards the movement of the vehicle moving at a speed of 66 km.h^{-1} ($\pm 4.8 \text{ km.h}^{-1}$) (Figure 8-20).

Saab Friction Tester (slip meter) represents an application of the anti-locking equipment used in the aeroplanes. The braking coefficient is determined on the basis of the value of peripheral force (braking force) measured at a tested wheel with the slippage adjusted to a constant 15%. The results from the measurements at a speed of 130 km.h^{-1} approximate to real conditions of an aeroplane moving on the runway.

Table 8-5 Friction data and descriptive terms of braking action

Measured coefficient	Estimated braking action	Code
0.40 and above	Good	5
0.39 to 0.36	Medium to good	4
0.35 to 0.30	Medium	3
0.29 to 0.26	Medium to poor	2
0.25 and below	Poor	1

The results from these methods are clearly not directly comparable. Therefore it is always necessary to state by which method, device and at which speed the braking action was determined.

Table 8-5 includes the data on the measured or calculated braking coefficients and their coding. The data were determined on the basis of experience and measurements with one type of deceleration meter and one type of continual measuring device at constant speeds. The braking action must be measured for every third part of the runway separately and coded results are reported in sequence for the touchdown zone, mid-runway position and the final third of the runway.

8.5 PAVEMENT MANAGEMENT SYSTEM

In the past, most airport operators have based their decisions about runway maintenance more on their previous experience and / or an urgent need, rather than on some sophisticated methods. This type of pavement maintenance was neither optimal nor effective. Later some enlightened engineers decided to use note cards to better prioritize the maintenance activities. However, these practices usually led to the selection of a few preferred maintenance strategies and an ineffective use of resources.

The Pavement Management Systems (PMS) have been used since the 1980s, initially in motorway and road maintenance. Although airport pavement design, operational conditions, pavement loading and maintenance needs differ considerably from the road industry, most states are still using pavement management systems originally designed for roads. In the USA the Airport Pavement Management Program is used. It was developed by the FAA (AC No: 150/5380-7A) and represents a special solution for the airport industry.

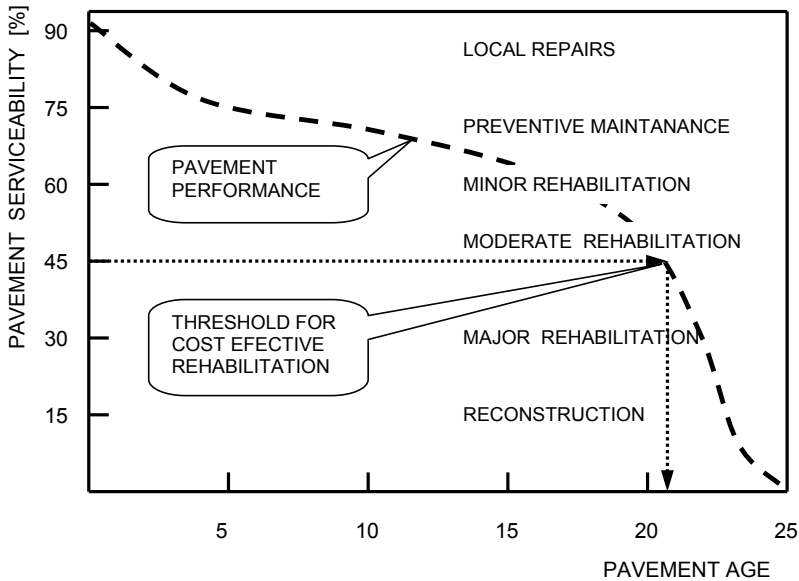

Figure 8-21 Pavement serviceability and the pavement age

The basic aim of the pavement management system is to determine the type of pavement maintenance and rehabilitation needed. The pavement management system is a set of tools and methods that support decision making to find a cost effective strategy for pavement maintenance. Each pavement management system should consist of two basic components. The first is a

database, which contains current and historical information on pavement condition, pavement structure, and traffic. The second part is a set of methods and tools that allow the determination of the existing and future pavement conditions, the assessment of financial needs and pavement maintenance technologies.

Each pavement usually maintains its characteristics and performs well for the majority of its life but after reaching a critical point it starts to deteriorate rapidly. By a complex evaluation of the pavement conditions, defining traffic loading and climatic effects, it is possible to determine an optimum time for interim improvements and major rehabilitation just before a pavement's rate of deterioration begins to increase (Figure 8-21).

A pavement management system generally includes:

- the information database
- structural pavement evaluation
- decision making systems
- financial requirements optimisation tools.

The information database is usually divided into subsections containing different types of information. It must contain data on the pavement structure history, pavement construction, materials used, composition of structural layers and thickness. The part of the database with the maintenance history forms a basis for evaluating the maintenance practices and for the cost-benefit analysis. An operational database contains information on the number of movements and type of airplanes using the pavement. Pavement condition data are based on routine and systematic inspections and pavement testing. The database usually contains results of pavement visual inspections, pavement friction characteristics, data from longitudinal and transversal pavement roughness measurements, pavement bearing capacities from deflection tests etc.

For the structural pavement evaluation a number of standard methods are used, but there are also new methods, like ground-penetrating radar, which complement or replace standard tests.

Although pavement management systems have been used since the 1980s, many changes have evolved in the field of pavement management, leading to the continued development and refinement of computerized capabilities and analysis tools.

9

AIRCRAFT GROUND HANDLING

Tony Kazda and Bob Caves

9.1 AIRCRAFT HANDLING METHODS AND SAFETY

Airline companies are the most important customers of any airport. Airlines can minimise their extra investment for growth by increasing aircraft daily utilisation. Many low cost carriers define the standards for time-effective handling quite strictly. Most of them require turnaround time not to exceed 25 minutes for a standard Boeing 737 en-route operation. A well-known phrase ‘the airplane earns only when flying’ holds true. Therefore, the basic requirements all airlines place on the ground handling are:

- ➔ to ensure safety of the aircraft, avoiding damage to it
- ➔ to reduce ground time
- ➔ to ensure high reliability of handling activities, avoiding delays.

The airport administration authorities are also interested in reducing the ground time. In order to cope with an expected growth of air transport, most large European international airports will have to invest in further development of their infrastructure. Apron capacity is the limiting factor for some of them. It would, therefore, be more advantageous for them to reduce the ground time and thus increase apron and terminal productivity without significant investments. A possible solution

could be an introduction of modern technologies for aircraft ground handling and new concepts of how to cut down delays at the airports. But there are many regional airports with one or only a few aircraft movements a day. When the requirements for technical handling at such airports are compared with those having busy air traffic, a considerable difference can be seen.

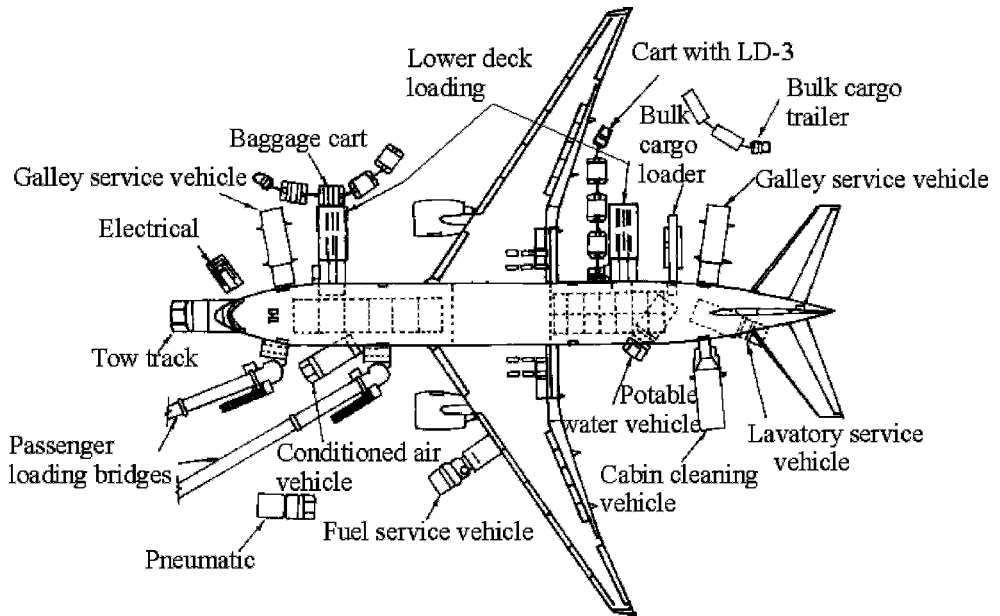

Figure 9-1 *The B-777 being serviced during a turnaround with the help of ground support systems and mobile equipment*

(Source: Boeing 777 Airplane Characteristics for Airport Planning)

The process of ground handling consists of a series of highly specialised activities. In order to carry them out, both highly skilled staff and sophisticated technical equipment are needed.

Three basic approaches to ground handling can be identified:

- the aircraft's own technical equipment is used as much as possible
- mobile technical equipment of the airport is used - a 'classical approach'
- airport fixed distribution networks with a minimum of mobile facilities, often called a 'vehicle free apron'.

Each of the above approaches has its advantages and disadvantages. Individual approaches can also be combined. The choice of a particular approach to ground handling is basically influenced by the following:

- airport size and its throughput
- type of flight, short and long-distance
- availability of capacity at the airport
- the intensity of utilisation of a particular stand
- aircraft size
- extent of ground handling required, depending on whether it is a line or end station
- environmental concern of the population.

Table 9-1 An example of the BAe-146 servicing at a turnaround

Activity	Time [min]	5	10
Stop aircraft			
Stop engines	█		
Supply power	█		
Air conditioning	█		
Deplane passengers		█	
Unload cargo/baggage		█	
Check airplane		█	
Load cargo/baggage			█
Board passengers			█
Start engines			█
Taxi into position			█

For short flights which are served with modern jet or turboprop aircraft it may well be required that the total time allotted to the ground handling during a turnaround should not exceed 10 to 15 minutes. In such cases the aircraft’s on-board equipment such as airstairs and the Auxiliary Power Unit (APU) is used for the ground handling as much as possible. The number of ground handling activities is reduced to a minimum. Most turboprop aircraft serving short distance flights cannot use stands equipped with common passenger bridges owing to the distance of the left power plant from the bridge construction and a low door-sill height.

The BAe 146 being serviced during a line turnaround can be taken as an example of a servicing

arrangement (Table 9-1). At most medium-sized airports aircraft are serviced either by means of mobile equipment or through a combination of mobile systems and fixed ground systems. Figure 9-1 shows ground support systems and mobile equipment of the B-777 for typical turnaround. When compared with a complex installation of the fixed ground systems, the former solution requires less investment. This way of servicing an aircraft is preferred also at those airports where competition among several ground handling companies exists. In such a case only a few companies are ready to invest in ground support systems which will have to be shared with competitors, e.g. fuel systems. The largest vehicle on the stand is usually the fuel bowser. The location of the bowser should be clearly marked on the apron, and an exit route should always be available in a forward direction away from the aircraft. The APU exhaust efflux or other dangerous areas should be avoided.

The apron at a large modern airport is not only the concrete or tarmac surface itself. In order to reduce surface traffic across the apron, to improve the apron utilisation and to reduce the ground time, the systems needed for servicing an aircraft are either buried in the surface or located under passenger bridges. The fixed ground systems considerably improve the apron safety by reducing the number of service vehicles on the apron and especially in the vicinity of the aircraft. But even when fixed ground systems are used, around 21 different pieces of ground support equipment might be employed for a standard Airbus 380 turnaround, a similar number as for existing large aircraft.

Apron accidents and incidents are sometimes not defined as aviation accidents and are investigated according to different standards. This practice contributes neither to the apron safety enhancement nor to the creation of a positive safety culture. The work environment on the apron is often not the best one for safe and speedy ground operations. The workers are exposed to congestion, stress, noise, jet-blast, extremes of weather and sometimes to low visibility conditions. The open apron space and differences in aircraft size may lead to a vehicle driver's misperceptions of the distance or the speed. Sometimes the workers are penalized for turnaround delays or schedule disruptions. Handling companies frequently employ low-paid and poorly motivated workers with a high rate of staff turnover. All these factors create potential hazards for apron accidents and incidents.

Apron accidents sometimes involve minor damage only, but when unnoticed or unreported, they may result in an airplane emergency. Minor damage can also be expensive for airline companies. Even if the aircraft repair may not be costly, the indirect costs resulting from the schedule changes and consequent disruptions are much higher.

The rate of apron incidents is shown in Figure 9-2. The survey was conducted by ACI in 2004 with 193 participating airports. It was the sixth year for which data has been collected. The main goal of the survey was to help to prevent future apron incidents and accidents. The survey reported 3 233 apron accidents and incidents during handling of 15 119 020 aircraft movements, giving a

rate of 0.214 incidents/accidents per 1 000 movements or one incident per 4 676 aircraft movements. The accident/incident rate differs considerably according to which continent is involved. According to the ACI Survey (2005) the highest rate is observed in Africa (0.574) and the lowest in Latin America and Caribbean (0.062 incidents/accidents per 1 000 movements). The pie chart (Figure 9-2) illustrates the percentage distribution of types of accidents and incidents in the year 2004. It shows the types of accidents/incidents which occur most frequently and need special attention. Apron incidents involving aircraft are most serious. These are often caused by passenger handling or aircraft servicing equipment. Damage either to aircraft by moving equipment or to moving equipment by other equipment can be considerably reduced by installing fixed services. The UK Health and Safety Executive, together with the industry, have been collecting and analysing data under an initiative starting in 2002 to reduce accidents during turnround. They found that, of those accidents requiring more than 3 day off work, 56% were caused by manual handling, 19% were slips or trips, 9% were hit by a moving object, 6% hit by a stationary object, 3% were falls from height. They have made it a target to limit manual handling of bags to a maximum of 23 – 25 kg (International Airport Review, Issue 4, 2006).

Figure 9-2 Causes of apron incidents/accidents year 2004

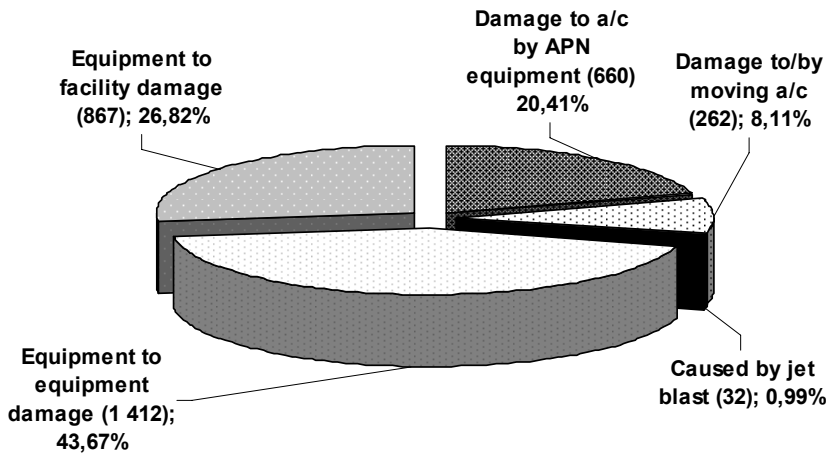

(Source: ACI Survey on Apron Incidents/Accidents, December 2005)

An apron equipped with fixed ground systems has a lower impact on the environment due to lower noise and exhaust emissions. Equally important is reduced traffic in the manoeuvring area. It also leads to saving on personnel which is significant especially in countries where the cost of labour is high. However, the latest initiative, the so called ‘free ramp concept’ is also found at China – Beijing airport. The equipment and networks buried in the apron require higher initial investment costs but, in general, reduce operational costs. It is, therefore, more suitable especially for airports

with high daily utilisation of stands. Before the decision concerning a particular type of ground handling is taken, it is necessary to carry out a detailed analysis.

Table 9-2 An example of the B-747 servicing at an end station turnaround

Activity	Time [min]	10	20	30	40	50	60
Position passenger bridges	1	█					
Supply power	1	█					
Deplane passengers	11	█	█				
Unload aft lower lobe	14	█	█				
Unload main deck cargo	25	█	█	█			
Service lavatories	30		█	█	█	█	
Service galleys	30		█	█	█	█	
Service cabin	29		█	█	█	█	
Service potable water	14.5		█	█			
Fuel aircraft	28		█	█	█	█	
Board passengers	18					█	█
Unload FWD lower lobe	10			█	█		
Load main deck cargo	28			█	█	█	█
Load FWD lower lobe	10				█	█	
Load aft lower lobe	14					█	█
Start engines	3						█
Power supply removal	1						█
Remove bridges	1						█
Push back	2						█

With fixed distribution networks buried either in the apron or fixed on passenger bridges, it is possible to provide:

- aircraft refuelling
- electrical power to aircraft systems
- telephone and data connection
- air conditioning
- compressed air for the engine start
- potable water
- lavatory service

- push back of aircraft
- transport of baggage to/from aircraft
- waste removal.

The ducts for air conditioning are light and of large diameter, so can be caught by the wind and blown about. This makes it difficult to control when trying to make a connection with the aircraft.

Table 9-3 Door sill heights of some aircraft types

Aircraft type	Door sill height [mm]
DC – 92	2130
B – 737	3100
Tu – 154	3200
DC – 8	3200
B – 767 – 300	4160
IL – 62	4200
A – 300	4500
B – 747	4700
DC – 10	4800
B – 777	5280
A – 380 – main doors	5340/*
A – 380 – upper deck doors	7920/*

In fixed systems, fuel is always supplied to hydrants through pipes buried in the apron, while the systems on the passenger bridges provide air-conditioning, power and compressed air supplies. It is important that servicing lines between the aircraft and the installation should be as short as possible and they should not cross one another. In the future, especially at airports which accommodate wide-bodied aircraft, a further expansion of ground support systems is to be expected. An example of a fully ‘automated airport’ where all systems are fixed at some stands is Stockholm-Arlanda (see Figure 9-3 showing fuel, air-conditioning, engine start air supply and electric power connections).

Table 9-2 shows individual technical servicing activities of the B 747 during a turnaround within a time limit of 60 minutes. All manufacturers supply Airport Planning Manuals that indicate the notional time needed for turnarounds without any operational difficulties, and also the location of all the servicing points and the way in which simultaneous activities can be carried out without mutual interference.

Next, some other activities arising from aircraft servicing are described, particularly those which implement technologies different from those used at small or medium sized airports. Aircraft refuelling will be described in Chapter 10 - Aircraft refuelling.

9.2 AIRCRAFT GROUND HANDLING ACTIVITIES

9.2.1 Deplaning and Boarding

Deplaning and boarding can be provided by means of:

- stairs carried by the aircraft
- mobile stairs
- mobile lounges
- passenger bridges.



Figure 9-3 Fixed ground handling systems ‘vehicle free apron’ - FMT Pop-Up Ground Support System (Photo: Courtesy FMT - Fabriksmontering i Trelleborg AB)

A combination is also possible, e.g. a bridge attached to the aircraft door behind the crew cabin and mobile stairs for the rear exit. The aircraft doorsill height varies considerably depending on the aircraft type (Table 9–3). Therefore, it is sometimes necessary to have a range of passenger stairs

or a range of stands equipped with different bridges at the ramp.

Although passenger bridges are more costly than mobile stairs, the former are increasingly used also at medium-sized airports. One of their advantages is that passengers can change between aircraft more quickly. While the aircraft is being boarded or deplaned, other servicing activities, including the aircraft refuelling, can be carried out simultaneously. The movement of the servicing vehicles across the apron is not obstructed. The safety of passengers is also ensured as the contact of passengers with servicing vehicles is avoided.



Figure 9-4 *The upper deck boarding bridge for Airbus 380 must be able to reach the 8 m (26.2ft) doorsill height (Photo: Courtesy Airbus company)*

The flow path of the passengers is straight-forward, and they reach their aircraft safely without getting lost. The quality of the whole process is improved as passengers are protected against bad weather. No significant change in level is experienced at the majority of airports and for most types of aircraft, as there are maximum allowable slopes on the bridge ramps.

At a few airports the passenger bridges are also used at the aircraft rear door, by extending over the aircraft wing. This speeds up boarding and deplaning and helps to shorten the turnaround time, but is not recommended by IATA. Some airports where the Airbus 380 will be handled guarantee simultaneous passenger boarding to the main and upper deck. However, for the 90 minutes

turnaround time two bridges on the main deck are sufficient. The upper deck boarding bridge must be able to reach the 8 m (26.2ft) doorsill height (Figure 9-4). In this configuration it is planned to achieve a turnaround time of 90 minutes, comparable to today's largest aircraft, though with 35% more passengers on board. The average boarding time is 5, and for disembarking 8, passengers per minute per tunnel. However, passenger bridges are more costly than mobile stairs and airline companies are charged for using them. Because of this, low cost carriers usually prefer mobile stairs or even the aircraft's own stairs.



Figure 9-5 *A part of the passenger boarding bridge crosses the service road*
(Photo: A. Kazda)

If the passenger bridge installed has a limited manoeuvrability, the stand has less flexibility. On the other hand, bridges of this type are less expensive than bridges with apron drive which have the ability to move I azimuth and can be fully adjusted for all aircraft types.

Passenger boarding bridges with two telescopically connected parts consist of the following main parts:

- rotunda

- telescopic tunnel
- pedestal with undercarriage
- crew cab
- aircraft servicing equipment.

The bridge can usually be extended by about 10 metres and the height can be adjusted within a range of almost 4 meters. The maximum incline of a bridge does not exceed 10% (Figure 9-5).

9.2.2 Supplies of Power, Air-Conditioning and Compressed Air

Most aircraft can meet their energy requirements on a ramp with an APU. Advantages of such a solution are independence of the ground source and saving on time required to connect/disconnect the ground source. However, the total costs of APU operations, including maintenance costs, are often higher than the charges levied by the airport for using external ground sources. Other disadvantages are low efficiency of the APU (only about 30%), and high noise and environmental pollution due to exhaust gases. At Copenhagen airport, APUs have to be turned off within 5 minutes after the plane docks and at Zürich airport this time period is reduced to 30 seconds. After that, the aircraft has to be supplied with external electrical power of 400 Hz, 115/200 V. The distribution is provided either from the central power source or from a static (non-rotating) converter installed on the loading bridge. Banning APU usage at airports can reduce airport pollution by almost 10%.

If there is no ground support system supplying air-conditioning, the pilot cannot avoid using APU in order to provide ventilating, heating or cooling in the cabin. In this case a ground source of electricity is not usually requested. Before the start of a long haul rotation, the aircraft needs power so that the maintenance engineers can check the systems. The seat-back facilities now being installed in aircraft require a lot of power and maintenance.

The A380 needs at least 3 x 90 kVA supplies, and possibly 4 x 90 kVA, compared with 2 x 90 kVA for the 747-400. The ground power connections are 2.6 metres above ground, requiring access steps. It also needs 4 air connections rather than the 747's 2 connections. Catering vehicles need to be able to reach the upper deck, which is possible with a double-scissors lift. All other servicing requirements are high but within the capability of existing equipment, though dedicated de-icing equipment is necessary to reach the top of the fin and four underwing pressure connectors are needed to fuel 261 000 litres in 90 minutes..

Air-conditioning has to be provided even in mild latitudes. Due to the high concentration of people

aboard, cooling of the cabin has to be provided when the temperature rises above 10 °C. When the temperature is between 4.4 – 10 °C air has to be circulated, and when it drops below 4.4 °C the cabin has to be heated. Central distribution systems can supply air of - 6.5 °C in summer and + 66 °C in winter. In order to start the engines compressed air of 230 °C is supplied.

9.2.3 Cargo and Baggage Loading

Cargo and baggage loading is a time-critical activity especially when handling wide-bodied aircraft serving long-haul routes and on charter flights. When servicing the B-747, it is necessary to load and unload about 6 500 kg of baggage and in the case of the A 380 this will rise towards 10 000 kg. An advantage of modern wide-bodied aircraft is that baggage is transported in containers. This reduces a number of bags going astray as the baggage for any one destination is stored in the same container. The containers are towed to the bag hall by tugs, in trains with a maximum of 5 dollies per train, or 3 in the wet due to the greater braking distances. Handling loose cargo and baggage is the most serious problem because such handling is time-consuming. Some airports use transporters to handle them, or they build systems of conveyers to transport the baggage from the departure hall directly to the aircraft. It is becoming desirable to power the tugs electrically, otherwise the bag hall has to be ventilated and the total of airport emissions increases. More detailed information on cargo handling can be found in the Chapter 11 – Cargo.

9.2.4 Push Back Operations

In order to improve apron utilisation, most of the large international airports are equipped with air bridges and nose-in aircraft stands. When ready for taxiing, the aircraft has to be pushed back into a position where it can use its own engines. Aircraft tugs of different designs are being used to push back the aircraft. The original push back unit was a traditional combination of a tractor and a towbar. An advantage of such a unit is a relatively lower initial cost when compared with other modern equipment. A disadvantage, especially at major airports, is the need for keeping different towbars for each type of aircraft. The towbar costs increase the overall investment needed for handling the nose-in stands. One towbar tractor requires at least two people to operate it (Figure 9-6).

When compared with some other methods, the towbar method has a higher labour requirement. Other disadvantages, from an operational point of view, are low speeds of operational towing, e.g. between apron and a hangar, and problems arising from pushing back heavier aircraft under poor braking conditions on the apron. However, initial trials carried out at Heathrow, where Pier 6 has been built to receive four A 380s, found that there was some snaking when towbarless tractors were

used to tow them, so they will use towbars for the time being. In order to provide the necessary adhesion, the tractors designed to handle the heaviest aircraft must also be very heavy. This results in higher fuel consumption. At some airports electrically driven tractors are also used.



Figure 9-6 A towbar tractor being connected to an aircraft (Photo: A. Kazda)

There are several types of towbarless tractors designed to push back or tow aircraft. PowerPush from the German company Schopf has developed a push back vehicle on a fundamentally different basis (Figure 9-7). The PowerPush is a towbarless pushback tractor can handle aircraft up to 100 metric tons. Unlike other vehicles for moving aircraft, this unit connects to the main landing gear, rather than to the nose wheel of the aircraft. Profiled friction rollers are placed hydraulically in contact with the tyres of the main gear wheels.

The rollers are driven by a hydrostatic engine and make the wheels of the main gear rotate. The pilot controls the aircraft according to directives received from the PowerPush operator. The aircraft's brakes can be used without damaging either the aircraft or the push back vehicle. When compared with conventional vehicles, this unit is very light, powered by only 58 kW (78 HP) engine, it is simple, and both its operational and initial costs are lower.

It can be remotely controlled. In such a case the operator of the vehicle has a direct visual contact with the pilot of the aircraft. Its disadvantage is that it can be used only for push back operations on an apron over a distance of from 50 to 150 m, and it is designed only for aircraft with one row of

wheels on the main landing gear. The airport therefore needs to have other vehicles designed for operational towing. A new PowerPush version capable of handling wide-bodied aircraft is being developed currently.

The FMT Company in Sweden has presented another interesting version called Push Back System. It is partly built into the surface of the apron. On taxiing, the aircraft nosewheel falls into the 'cradle' of the equipment. On push back, the cradle is pulled by a hydraulically driven chain located under the surface of the apron.

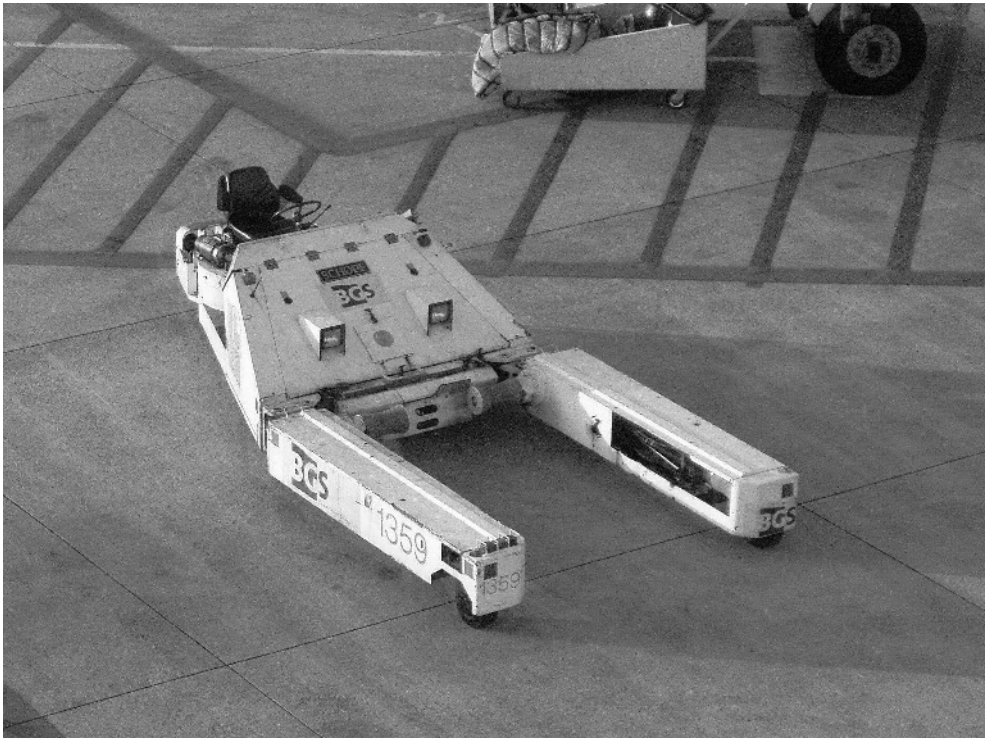

Figure 9-7 *A towbarless PowerPush tractor, Schopf company (Photo: A. Kazda)*

Many companies currently offer towbarless tractors designed for push back or operational towing at high speeds. In most cases the tractor picks up and lifts the aircraft's front wheel off the ground hydraulically (Figure 9-8). The wheel is clamped firmly. When compared with a conventional type, this tractor can be lighter as the required adhesion force is induced by the aircraft itself. The impacts which are transmitted to the nose undercarriage leg when a towbar is used for towing or pushing back, are, in this design, damped by the aircraft tyre. The main benefit of this system would come when towing an aircraft from the apron to the end of the runway before take off. The economic benefits are fuel savings on taxiing, e.g. a B-747 at Frankfurt needs on average 607 kg of

fuel for taxiing to the end of the runway. Consequently, there is a cleaner environment at the airport and its surroundings. For countries with high labour costs it is also of interest that the tractors of this design are operated by a single person. The disadvantage is a higher initial cost of the unit. In fact, due to persistent operational and legislative problems, it has not yet been generally possible to introduce operational towing.



Figure 9-8 Heavy Goldhofer towbarless tractor (Photo: A. Kazda)

The design of the aircraft's nose gear legs have not been designed to transfer loads when towing an aircraft at higher speeds for long distances, but only for short distances on push back. It would be necessary to build new special tow tractor roads for the return journeys to the apron from the holding bays. There is also resistance from the airlines, who fear that any problem with starting the engines could mean a long return trip to the stand. Another question which has not been decided is who is legally in control of an aircraft when it is under operational tow. Is it the pilot or the driver? Despite all the questions mentioned so far, the costs of the vehicles will gradually go down and they can be used in major airports or the airports where a clean environment is of primary concern.

9.3 COLABORATIVE DECISON MAKING (CDM)

The biggest advantage which the air transport has compared with other transport modes is speed. However, even though the planes get faster, some airlines have increased the scheduled flight times on their routes to accommodate growing delays. Since 2000 the en-route delays have dropped but the delays at the airports has grown considerably (Figure 9-9). These disruptions in the airport operations have a domino effect and hence a widespread impact. At an airport, for example, some of the handling partners services might be delayed or not delivered, there could be a failure found on the vital airport systems after the engine start up etc. Small disruptions of 2–5 minutes could result in hours at the end of a day.

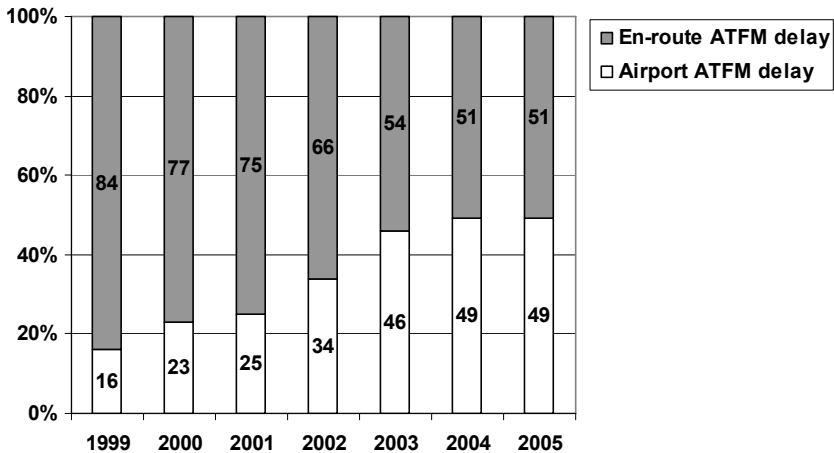

Figure 9-9 *ATFM delay distribution by delay reason*

(Source: Eurocontrol PRR 2005)

Sharing the latest information on the operational issues, data exchange and the enhancement of the operational decision making capabilities make air traffic more predictable and result in minimising disruptions. However, some partners may be reluctant to release certain information when they consider them as ‘commercially sensitive’. Also the information systems of the main CDM partners were usually built without co-ordination and are incompatible.

To increase the airspace and control capacity while maintaining safety, as well as to meet future air transport needs in the ECAC states, a new Gate-to-Gate and ATM Strategy 2000+ was adopted. Principal points of this new concept among others are:

→ flight management from gate-to-gate

- enhanced flexibility and efficiency
- collaborative decision making (CDM)
- collaborative airspace management.

The CDM concept was successfully tested at San Francisco International Airport at the beginning of 1998 in order to cope with large reductions in capacity and then it was extended to all U.S. airports by the end of 1998.

According to Airport CDM Operational Concept Document (Eurocontrol, May 2006) Airport Collaborative Decision Making is a concept which aims at improving Air Traffic Flow and Capacity Management (ATFCM) at airports by reducing delays, improving the predictability of events and optimising the utilisation of resources. In this operational frame all airport CDM partners (at least airport and aircraft operators, handling companies, ATM and CFMU) can optimise their decisions in collaboration with other CDM partners. This is possible due to the fact that every one knows the preferences and constraints of the other shareholders as well as the actual and predicted situation. The decision making is achieved by the sharing of information, by common procedures, mechanisms and tools. The Airport CDM concept is divided into the following elements:

- Airport CDM Information Sharing
- CDM Turn-round Process – Milestones Approach
- Variable Taxi Time Calculation
- Collaborative Management of Flight Updates
- Collaborative Predeparture Sequence
- CDM in Adverse Conditions
- Advanced CDM.

CDM Information Sharing is a basic step for implementing of any other element and for this reason it must be put into practice first. It is also a pre-requisite for creating the common situational awareness (CSA) of each stakeholder and for improving the co-ordination and operational planning of the CDM partners.

The **CDM Turn-round Process (Milestone Approach)** is aimed at particular turn-round processes and the prediction of their termination. The interrelations of the processes and their linking to the flight planning and CFMU must be ensured. The milestones contribute substantially to the pre-flight and post-flight predictability. It is inevitable for further system planning improvements.

By implementing the **Variable Taxi Time Calculations** the accuracy of aircraft ground movement

and calculation of take-off times is improved.

Collaborative Management of Flight Updates provides the required operational flexibility of ATFM to facilitate modifications of departure times with respect to traffic changes and operators' preferences. Variable Taxi Time Calculation and the CDM Turn-round Process elements must be operational before implementing this level of CDM.

Collaborative Predeparture Sequence is a pre-flight 'count down' sequence which contributes to flexibility, predictability and to the optimisation of the airport facilities and equipment.

Airport capacity during low visibility operations (see also 3.3) could be enhanced by introducing ***CDM in Adverse Conditions***. This element facilitates the dissemination of capacity changes and recovery from operational disruptions. CDM in Adverse Conditions also ensures flexibility and optimum use of airport CDM partner resources.

The ***Advanced Concept Elements*** are not defined yet. These Elements will further improve CDM partners' situational awareness and increase the collaboration by introducing airport advanced control and surveillance technologies and tools like A-SMGCS, AMAN / DMAN.

The most important CDM goal is focussed on the improvement of flight operations by participation of airline companies, airport operators and handling companies in the process of Air Traffic Management (ATM). This is achieved by information management systems and procedures and implementing functions which take into account internal priorities of particular aircraft operators and/or other stakeholders to make full use of the shared data. CDM partners can in this way synchronise their operation but also support other shareholders by feedback.

The CDM concept generates very high added value with relatively low costs. However, the full benefits will only be enjoyed after implementation of the project scope on a wide European basis. The whole CDM project is planned in four basic stages (ZZ):

- Level 1 Airport CDM Information Sharing and CDM Turn-round Process
- Level 2 Collaborative Management of Flight Updates and Variable Taxi Time Calculation
- Level 3 Collaborative Predeparture Sequence and CDM in Adverse Conditions
- Level 4 Other CDM applications.

9.4 VISUAL GUIDANCE SYSTEMS

Semi-fixed passenger loading systems with a small range of adjustment are less expensive than the fully mobile bridges. They do, however, have less flexibility and need precise positioning of the aircraft in order to avoid damage and also to attach the equipment needed for the aircraft servicing.

It is, therefore, particularly necessary to install visual guidance systems to facilitate the positioning, though guidance systems are usually installed also at stands equipped with fully mobile bridges. Exact positioning is possible also when the aircraft is guided manually by a marshaller, but when an airport accommodates wide-bodied aircraft, the pilot often cannot see the marshaller easily from the cockpit. When the aircraft is damaged, it is often difficult to decide whether it is the marshaller or the pilot who is to be blamed for the damage. At large airports where passenger boarding bridges are usually installed it is therefore vital to implement guidance systems.

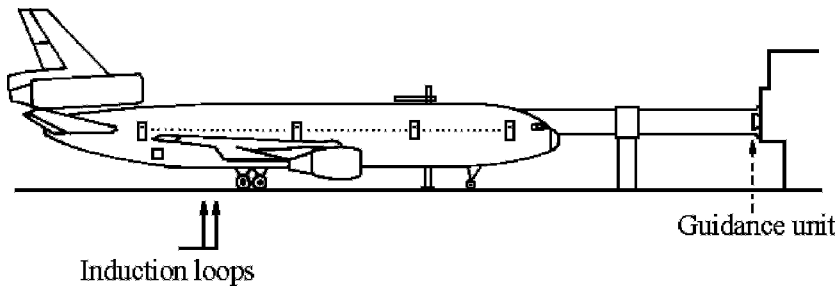

Figure 9-10 Principle of Safegate visual guidance system

One of the first guidance systems was installed at the airport in Atlanta, Georgia in 1956. The simple and cheap equipment consisted of a stick attached on the passenger loading bridge to a tennis ball with a rope. It was installed at stands designed for the Douglas DC-6. The aircraft was parked correctly when the tennis ball touched the windscreen. A disadvantage was that the guidance system could be used for one aircraft type only or it would be necessary to move the tennis ball.

A modern but more advanced modification of the above mentioned stick, rope and tennis ball is a system with a hydraulically controlled arm. Data about types of aircraft using the stand are stored in a computer memory. The computer adjusts the position of a robotic arm to the position required for the pre-selected aircraft type. At the end of the arm there is a light tube containing sensors. The aircraft has to touch the tube with its windscreen. If the aircraft does not stop, the arm keeps moving with the aircraft.

The Swedish company Inogon International AG makes use of two indicators working on a principle of interference of light to guide the aircraft along the centre-line and to indicate distance. In a box-like indicator there is a fluorescent light below which two grids are located and where interference of light takes place. The resultant patterns are called moiré (Figure 9-11). Their shape depends on the line of vision. The centreline beacon provides directional guidance for the aircraft. Another indicator located obliquely from the pilot's line of vision gives the distance of the aircraft from the

stop position at the stand. Black lines shaped like arrows direct a pilot to the correct position on the stand. In the stop position the pilot can see black perpendicular lines in the centre of both indicators. The system has no moving parts, and its production and operation are simple. Another modern system installed at Stockholm Arlanda, is a system which uses data from the radar. The main advantage of this system called APIS (Aircraft Parking and Information System) is that it requires no sensors located on the tarmac. The radar measures the distance of the aircraft to its final position where it is to stop. The pilot maintains direction by following the indicator which makes use of interference of light on a grid, as already mentioned.

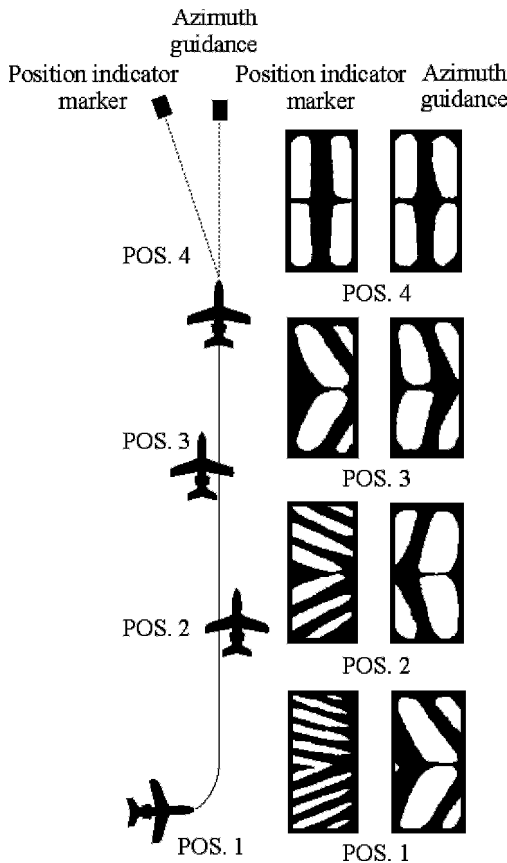

Figure 9-11 *Visual guidance system of Swedish company Inogon working on the principle of interference of light*

Exact parking of the aircraft is enabled also by another parking system produced by Safegate SATT Electronics AB (Figures 9-10, 9-12). Its advantage is that information about direction and distance is provided at a single source. Centreline guidance is provided by a vertical illuminated green bar which is, from the pilot's line of vision, displayed in a yellow symbol of an aircraft painted on the surface of the guidance panel. The information about forward motion of the aircraft is presented on a vertical panel through sequential activation of green lights. Exact, final positioning of the aircraft is indicated by flashing red lights (Figure 9-12). The position of the aircraft nosewheel is sensed through induction loops placed under the apron surface or through a different system of nosewheel distance measuring. The data concerning the aircraft position are processed by means of a microprocessor. Before the manoeuvre starts, the data about the aircraft type have to be recalled from the memory of the computer. They are, for confirmation, displayed in the top part of the guidance panel.

A new concept and different technology is used in Honeywell's Visual Docking Guidance System (VDGS) (Figures 9-13, 9-14). This fail-safe aircraft guidance system utilises a high dynamic range video sensor unit and a powerful image processing system based on 3D aircraft models. The computer-assisted VDGS calculates precise information on an aircraft's location and transforms it into precise guidance information for both pilot and co-pilot.



Figure 9-12 Typical installation of the Safegate guidance system (Photo: A. Kazda)

Its video sensor and 3D model-based processing system are able to recognize the outline of an approaching aircraft at distances of up to 100 meters. The Sensor Unit is a high dynamic range, passive video camera which could be also used for the aircraft stand permanent monitoring and thus it can enhance the safety and security of the stand operations. The system provides continuous data registration and could be used as an input for automatic reporting of ON-BLOCK/OFFBLOCK times in the CDM concept (see 9.3).

Some airports today prefer relatively low cost and simple systems. The airport authorities are less keen to use equipment requiring sensors and cables which need to be installed on the tarmac. When new types of aircraft are later introduced and, consequently, the stand configuration is to be

changed, relocation of sensors is a costly procedure.

Among these low cost, simple and reliable systems is one called AGNIS (Azimuth Guidance for Nose-in Stands) which is widely used at many airports for directional guidance of aircraft to stands, with a Side Marker Board (SMB) or Parallax Aircraft Parking Aid (PAPA) to indicate the distance of the aircraft from its final position. Any skilled carpenter or electrician is able to construct SMB and PAPA.



Figure 9-13 Honeywell's Visual Docking Guidance System (VDGS)
(Photo: Courtesy Honeywell)

The SMB indicator (Figure 9-15) consists of a white indicator placed on the pilot's left-hand side, where the passenger boarding bridge is. Perpendicular boards indicating a particular aircraft type are installed on the indicator vertically in distances which correspond to each aircraft type. The front part of the board, seen by the pilot, is painted green, the edge is black and the reverse side is red.

The pilot has to stop so that he can see only the black edge of the board which corresponds to the particular aircraft type. A disadvantage of the system is that the accuracy of parking depends on the position of the pilot's head. When the pilot has long legs and his seat is well back, he parks 'long' and the pilot with short legs parks 'short'. Some cases were reported with a B-737 that, when the pilot was too short, a stall speed indicator placed near the aircraft door was damaged.

The AGNIS indicator is placed on the stand centreline. Two vertical illuminated light tubes emit green and/or red light through openings, thus indicating a position of the aircraft on or away from the parking centreline. A disadvantage of this system is that pilot has to refer to two sources for

information.

The PAPA indicator is located in the right side of the stand centreline. The indicator consists of a black board with a longitudinal opening. Aircraft positions are indicated through white perpendicular lines showing a particular aircraft type. At a certain distance behind the board there is a fluorescent light tube placed vertically. When taxiing to the stand the fluorescent light in the opening seems to move. When the aircraft is parked accurately, the pilot can see the fluorescent light tube behind the white line which corresponds to the particular aircraft type.



Figure 9-14 Honeywell's VDGS installation at Brussels airport (Photo: A. Kazda)

The principle on which the Burroughs Optical Lens Docking System (BOLDS) system operates, used mostly in the USA, is similar to that of the PAPA system. A difference is that the distance is indicated by means of a tube placed horizontally, and the direction through a vertical fluorescent light. Optics consisting of a Fresnel lens are placed in front of the light source. An advantage of the BOLDS, shared with the Safegate Docking System and UCRAFT, is that it provides

information on both direction and distance from one source. When compared with the latter systems, the former is simpler and cheaper.

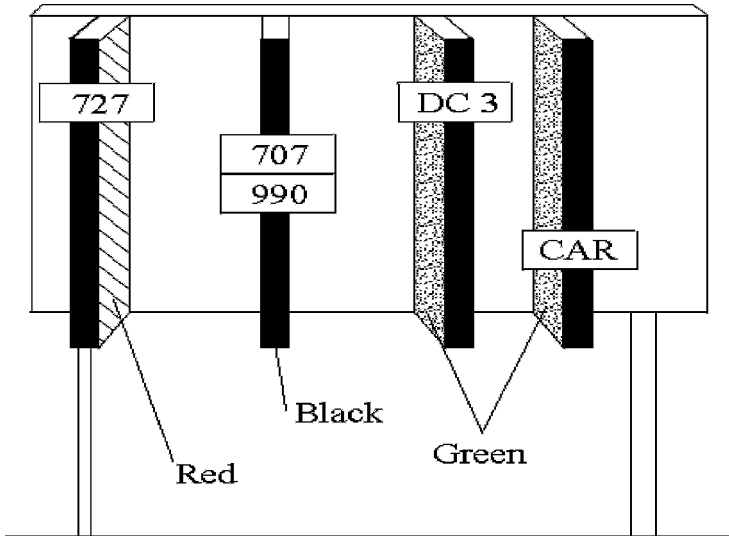

Figure 9-15 Side Marker Board

Also simple and low cost is the equipment installed at Gatwick in London for exact positioning of aircraft. Positions of the nosewheels of different aircraft types are painted on the apron surface. In front of the stand, on the left from the pilot's line of vision, there is a mirror in which the pilot can see the nosewheel of the aircraft when parking to a desired position. In winter the mirror is heated.

This survey of visual guidance systems is not complete. The choice of a suitable system depends on many factors, mainly traffic density, number of aircraft types using the particular stand and also on prevailing meteorological conditions. Future development of guidance systems will follow two paths which can be called respectively 'hi-tech' and 'beauty is in simplicity'. Meanwhile, the proliferation of types of guidance system can cause problems for pilots due to lack of consistency.

10

AIRCRAFT REFUELLING

Tony Kazda and Bob Caves

Motto: Fuel is the blood of aviation

10.1 BACKGROUND

In the early days of aviation, storing of fuel and aircraft refuelling was an undemanding activity. Piston engines had low consumption and the aeroplane was not able to carry a large quantity of fuel. The aeroplanes were refuelled from barrels or tankers. It was not necessary to build fuel stores at the airport. The same fuel as for cars was used for aeroplanes.

Initially, the requirements for quantity and quality of fuel gradually increased. Introduction of the jet aircraft in the late 1950's changed overnight the requirements, both qualitatively and quantitatively, for storing and supplying the aircraft with fuel. New aeroplanes required greater quantities of fuel, yet had to be refuelled within the normal turnaround time of less than 1 hour. Another great change occurred in 1970, when the wide-body Boeing 747 was introduced into operation. About 150 000 litres of fuel had to be transported through four refuelling openings with a diameter of 64 mm into the tanks of that aeroplane at a height of 4.5 m within approximately 45 minutes. If there was no hydrant fuel system at the airport, refuelling was provided by tankers with a capacity of up to 80 000 litres of fuel. At present the aircraft kerosene Jet A1 is the most common kind of fuel. For comparison, the following table gives volumes of the tanks of the

selected types of aircraft:

Table 10-1 Fuel tanks capacity of selected types of airplanes

Airplane	Fuel tank capacity (standard) [1]	Fuel tank capacity (long range version) [1]
Prop- and turboprop		
IL – 14	3 500	
IL – 18	23 500	
DC – 7C	29 800	
Jet		
BAe 146	11 728	12 901
Caravelle	19 000	
B 737-500	20 105	23 170
A 300-600 R	68 150	73 000
IL-62 MK	105 000	
A 340-200	135 000	
DC 10-30	138 294	153 434
B 747-100B	181 970	
B 777-200LR	202 270	
B 747-400	204 350	216 850
A 380 – 800	310 000	

The consumption of fuel has risen less rapidly than the air transport traffic. In the period 1960 to 1995, passenger km grew at 8.9% per annum and aircraft departures grew at 2.7% per annum. Over the same period, the fuel used per passenger km reduced by 2.5% per annum. This improvement in fuel productivity is caused by:

- a gradual growth of the percentage of aircraft seats filled (load factor), by the European airlines in particular
- a gradual substitution of new modern types of aeroplanes with lower unit consumption than the old ones
- changes of flight procedures and wide use of flight management systems.

Fuel productivity gains have slowed to about half these levels since the mid 1980s because the average aircraft size has stopped increasing and there has been more congestion in the system.

10.2 FUEL - REQUIREMENTS

The basic requirements for the provision of fuel at an airport are to ensure:

- high purity of fuel
- sufficient supply of fuel
- economic and rapid supply of fuel to aeroplanes
- environmental protection
- high safety standards of the operation.

10.2.1 Requirements for Fuel Quality

In order that the stringent safety requirements can be observed, the international organisations in co-operation with the major oil companies have prescribed criteria that the aircraft kerosene Jet A1 must comply with.

During the flight of an aeroplane at high altitudes, the temperature in the aircraft tanks drops under $-40\text{ }^{\circ}\text{C}$. Therefore the fuel must not freeze even during long time exposure to very low temperatures and must have the required viscosity. A resistance against freezing depends in particular on the proportion of paraffin in the fuel, which crystallises at low temperatures. With Jet A1, crystals of paraffin may not occur in the fuel above a temperature of $-47\text{ }^{\circ}\text{C}$.

Fuel is used in the aeroplane for cooling the on board equipment, and therefore it may be exposed to high temperatures. Even at a temperature of $260\text{ }^{\circ}\text{C}$, the fuel must be thermally stable and must not create deposits. Thermal instability of fuel may be caused by the presence of trace elements. Their precipitation is obtained by the use of additives to the fuel.

Fuel must not be corrosive so that it cannot damage parts of the fuel system and the aircraft engines. Corrosion is caused mostly by the presence of sulphur in the fuel. Sulphur is removed from fuel during its production. Some compounds of sulphur, for example hydrogen (mono)sulphide, may be created by the activity of micro-organisms.

Fuel must not contain active surfactants. The active surfactants act on the water as emulsifiers, and prevent its removal from the fuel. The active surfactants are removed from the fuel by means of clay filters which are located before the micro filters.

The fuel must not contain more than 0.003 % of free water. With higher contents of free water, the

ice crystals might block the filters after a drop in temperature. In addition, the presence of water supports the growth of micro-organisms in fuel. The free and dissolved water is removed from the fuel during its production in refineries. It leaves the refinery within its specification. However, during its transport and storage, water gets into it by the so called 'breathing' of the storage tanks. 'Big breathing' indicates a penetration of fresh air into the storage tank while it is being emptied. The atmospheric humidity condenses when there is a variation of temperature on the walls of the storage tank, and water gets into the fuel. 'Small breathing' occurs in the storage tanks during a change in the volume of fuel and air, as a consequence of variations of temperature between day and night. It happens in railway containers in particular. In addition, aircraft kerosene is hygroscopic, and in a damp atmosphere it readily absorbs water. Therefore water should be removed from the fuel every time it is transferred from one container to another.

Similarly, solid impurities get into fuel during its transport and storage. They are mostly rust and dust from the walls of the containers. As it enters the aircraft's tanks, the fuel must not contain more than 3 g of solid impurities per 1000 kg of fuel with the size of impurities not greater than 5 μm .

Large volumes of aircraft kerosene must be pumped into the tanks of an aeroplane within a relatively short time while ensuring its high, almost pharmaceutical quality. This is possible only with correct construction and maintenance of the equipment and by following the prescribed procedures.

The construction of storage tanks must eliminate any possibility of water or impurities getting into the storage tanks. The bottom of the storage tank must be given a gradient, and at the lowest point there must be a drain to draw off the water and sediment. Similarly, the pipework must also have a minimum gradient and at its lowest point be equipped with sediment discharge valves.

Treatment of the fuel during its transport and storage must ensure that, when used, the quality of fuel approaches the same quality it had when it was leaving the distillation column. The delivery of fuel must be accompanied by a certificate guaranteeing its quality. The certificate should be presented whenever the fuel is handled. Techniques to maintain the quality include sedimentation, discharge of the water and sediment, suction from the surface, filtration, and separation.

After delivering the fuel into storage tanks in the airport, the fuel must rest quiescent for a prescribed period of time in order that the impurities and free water can settle to the bottom of the storage tank. The time for sedimentation of the impurities depends on the height of the fuel column in the storage tank, and is about 3 hours per metre. Therefore, in the airport there should be at least three storage tanks so that, at any time, one of them is being filled, another resting quiescent, and aircraft refuelling is done from the third.

Suction of the fuel from the surface ensures that the relatively cleanest fuel is drawn out. A suction pipe is divided into a fixed part and a movable part which are connected with a joint. In the end of the movable part there is a float which maintains the intake of the suction pipe just below the surface.

Filtration is a process by means of which solid impurities are removed from fuel. The filters operate with a gauge of 3-10 micrometers. If the filter has a filtration gauge of, for example, 5 micrometers, it does not mean that larger particles do not pass through the filter. Elongated impurities may pass through the filtering pore even if their length is more than 5 micrometers. In the majority of cases centrifugal separators are used for water separation, or a double-stage filter.

Sometimes, mostly in subtropical and tropical zones, micro-organisms may be observed in the fuel system filters or tanks. In the majority of cases, they are micro-organisms which use the aircraft kerosene as a power source for their metabolism. In some fuel stores *Cladosporium resinae* mould was discovered. That species of micro-organism is very small and easily passes even through fine filters. The protection consists in an exhaustive cleaning and disinfecting of the affected sections of the fuel system including replacement of filters.

10.2.2 Fuel Storage

A problem with ensuring the fuel stays within specification is that the demand varies considerably during the year. The consumption in the peak is approximately 60% higher than in the off-peak months. In some airports there are also significant weekly variations in the demand. The storage capacities of fuel in the airport should be determined depending upon the reliability of fuel supplies and of variations in the demand. When determining the number of individual storage tanks and their capacities, consideration should be given to the peak daily consumption, the already mentioned reliability of fuel supplies, the state regulations and the required reserves of fuel. For example according to EU regulations EU Member States have an obligation to maintain minimum stocks of crude oil and/or petroleum products to at least 90 days' average daily internal consumption in the preceding calendar year [70]. It is expected that this amount will increase in the future.

The required reserve is the quantity of fuel that is in the store, which may not be used at that time to refuel the aeroplanes. Fuel must be treated (see the preceding section) and depending upon the manner of transport of the fuel to the airport, it is sometimes necessary to analyse it. In the event that the fuel samples do not correspond to the specification, the fuel may be returned to the supplier. Therefore the required reserve must cover a sufficient quantity so as to ensure a continuity of supply for airlines.

The quantity of fuel reserves at the airport must take into account also emergency situations and possible alternatives of fuel deliveries. Heathrow Airport diversifies the deliveries considerably and in normal operations gets thirty five per cent from the Buncefield Fuel Depot, about a quarter from a depot at Fawley near Southampton and a further quarter from a facility at Walton-on-Thames, Surrey. Another 15 percent of fuel comes by rail. In case of the Buncefield Fuel Depot fire on the 11 December 2005 Heathrow airport lost 35% of its fuel supply. The airport company has increased the amount of fuel from other suppliers according to contingency plans. The amounts of fuel available for uplift by some carriers were reduced by up to 60% compared with normal operations. At the beginning, the preliminary measures differentiated between base and visiting carriers with base carriers being given higher fuel allocations. Normal consumption at Heathrow Airport is 20-21 million litres of Jet A1 per day.

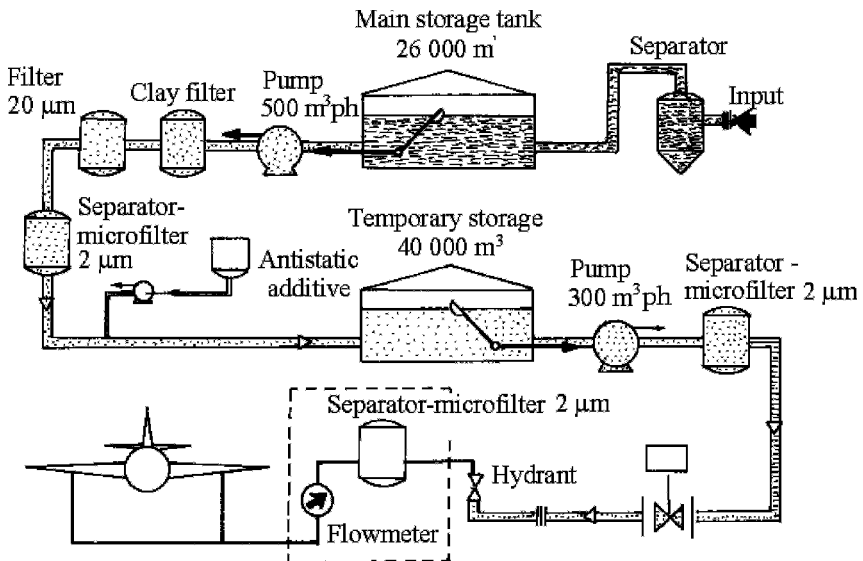

Figure 10-1 *The fuel system at Charles de Gaulle airport*

Fuel is transported to stores in the airport in the following ways:

- by a pipeline directly from the production plant or the oil company's storage facility
- by ships or barges
- by railway containers
- by lorry-mounted containers.

Transport by pipeline is particularly suitable for large airports, or if the airport is situated near a refinery. In such cases, and if a reliable supplementary supply of fuel is available, the requirement for constructing large stores of fuel directly on the airport is reduced. A pipeline supplies the fuel stores at Heathrow, Gatwick and Stansted airports. In some cases it is advantageous to transport the fuel by pipeline even for long distances. For example, a 100 km long pipeline supplies the Jet A1 from the refinery at São José dos Campos in Brasil to the new São Paulo Guarulhos airport.

Supplying fuel by truck is more suitable for small airports. However, there are exceptions. Some airports with throughput of approximately 5 mppa (million passengers per annum) supplied their fuel stores exclusively by truck, with about 100 containers per day.

Figure 10-1 shows a scheme of the fuel system at Charles de Gaulle airport in Paris. Before filling the fuel into the main storage tank, water is separated from the fuel in a separator. After sedimentation and the discharging of water and sediments from the storage tank, the fuel passes through a clay filter with a gauge of 20 μm . Then the fuel passes through the fuel system. Static electricity accumulates in it due to the friction from the piping walls, so the system has been designed in such a manner that the velocity of fuel does not exceed 3 $\text{m}\cdot\text{s}^{-1}$, and an antistatic additive is added. Static electricity is discharged from the fuel during its temporary storage in a delivery storage tank. Before aircraft refuelling, the fuel is once more cleaned in a filter with a gauge of 2 μm and for the last time in a filter directly in the delivery dispenser.

Fuel storage creates a potential danger in that leaks may affect the quality of underground and surface waters, and the soil environment. The danger may be limited by obeying the fuel technology and construction measures.

Storage tanks may be underground or overground, the decision being made on the basis of a special study for each case. The underground storage tanks are mostly used in smaller airports with volumes of individual storage tanks up to 120 m^3 , rarely up to 300 m^3 . The underground storage tanks are, with respect to national standards, usually designed with double jackets, or with a single jacket located in an impermeable caisson. When double-jacket storage tanks are used, the cost of the technology is higher, while when single-jacket ones are used the price of the construction works is higher. In some countries, a cathode protection of the storage tank against corrosion is considered to be sufficient to secure the storage tanks against fuel leakage. The price of the overground storage tanks themselves is usually lower than that of the underground ones. However, the fire regulations require the overground storage tanks to have greater safety distances from other objects and prescribe the availability of considerable fire-fighting equipment. The overground storage tanks are situated in pits which are able to retain the fuel in the event of an accident. The storage tanks should be cleaned on a regular basis, usually once in three years, and are subject to prescribed tests.

The fuel storage facilities at Prague Ruzyně airport have 6 storage tanks and a total volume of 4.8 million litres. This is a relatively very small amount compared with fuel storage capacity at big airports which can reach hundred million litres of fuel with daily throughput of more than 20 million litres.

10.3 FUEL DISTRIBUTION

Distribution of fuel from the fuel storage on the airports into aeroplanes may be executed basically in two ways. One is a distribution to aeroplanes by tanker, the other is a distribution by fixed systems directly into aeroplanes. Both of the systems have their advantages and disadvantages, and both of them, naturally to a different degree, are used at small as well as large airports.



Figure 10-2 *Aircraft refuelling by fuel dispenser blocks off a minimum of space during operation (Photo: A. Kazda)*

In small airports with a large number of general aviation aeroplanes, it is often more appropriate to install a fixed fuel delivering system, to which the aeroplanes will taxi. Similarly, it is advantageous to install a hydrant system, for example at a heliport with more stands. In both cases,

the principal advantage is a reduction of operating costs and an increase of safety and reduced danger of contamination during aircraft refuelling. At smaller airports the larger aeroplanes are usually refuelled by tanker, since at airports with low volumes of fuel deliveries, it is not economical or efficient to install a fixed system to each individual stand. Within a certain time, fuel in the systems degrades, its quality is not ensured, and part of the fuel should be sucked out before aircraft refuelling.

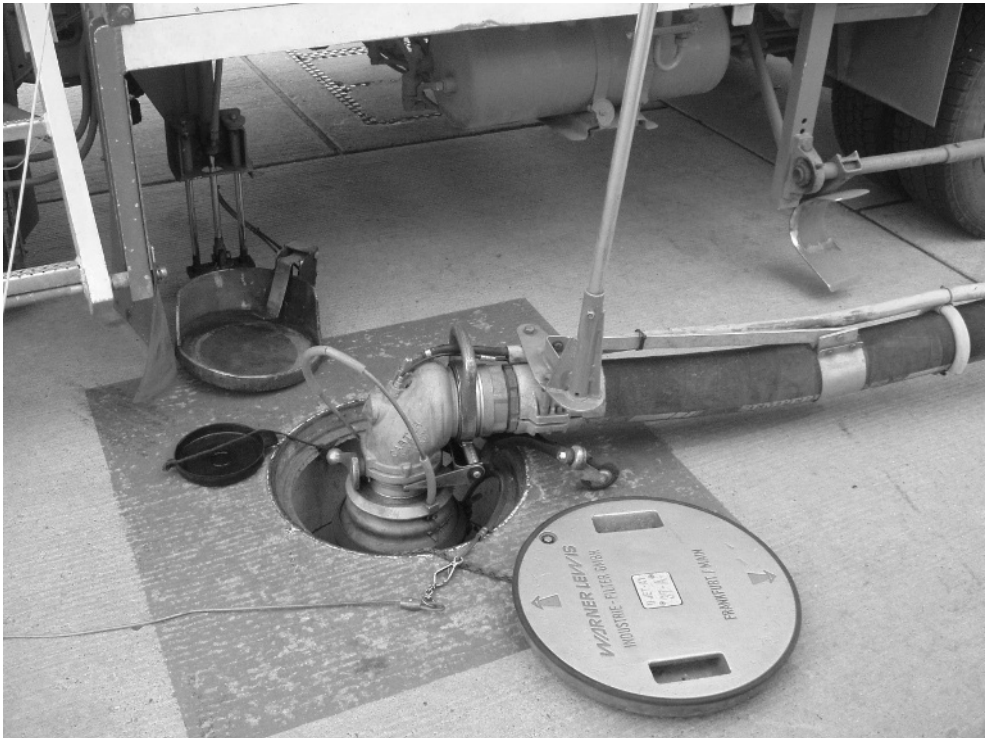

Figure 10-3 *Detail of the fuel hydrant (Photo: A. Kazda)*

At the present time, the administrations of most large international airports prefer hydrant fuel distribution. The decision in favour of fixed installations is not only made on cost grounds, but also for operational reasons.

At an airport with wide body Boeings 747 turnrounds, the fuel supply to a single aeroplane usually amounts to 100 m³ or 80 tons of fuel. With a hydrant distribution system, in the majority of cases a single worker with one dispenser, which is only a light vehicle, can perform the aircraft refuelling (Figure 10-2). The dispenser has equipment for reducing the operating pressure of fuel in the system, which reduces from 2 MPa, to a value of 0.35 MPa, the pressure of aircraft refuelling. Besides that, there are filters and fuel quantity measuring instruments, and a height adjustable

manipulation platform. A safety valve, most often of the Dead Man's Handle type, is installed between the hydrant (Figure 10-3) and the dispenser, which in the event of a failure closes the fuel intake. In comparison, two or three tankers with operators are required for refuelling a high-capacity aeroplane (Figure 10-4). The tankers obstruct a large space around the aeroplane and impede other activities. Another advantage of the hydrant system is in an increase in safety. There are no tankers on the apron with a large quantity of highly inflammable fuel, but only a dispenser with fuel in hoses from the hydrant to the aeroplane and in the filters.



Figure 10-4 B-747 refuelling requires sometimes more than one tanker (Photo: A. Kazda)

Tankers and dispensers must be parked somewhere. The operator prefers to park and fill tankers in the closest proximity possible to the apron in order to increase their utilisation and reduce costs. But the areas near the apron are commercially the most valued, and with the large size of vehicles, the price of the lease will be high. If the parking lot is located further away, the tankers add to the traffic on the service roads and in the event of an accident, they increase a possibility of spillage and fire. In contrast, the main parking area for dispensers may be situated even outside the central part of the airport. Only those dispensers that are immediately needed will be on the apron. The other equipment of the hydraulic system, storage tanks, pumps, filters, etc., is generally located off the apron.

Unless they are fully drivable, passenger loading bridges limit to some extent the flexibility in where the aircraft can park in relation to the hydrants, but the hydrants also limit the location of the aircraft due to the limitation on the length of the hose from the hydrant to the aircraft refuelling point. However, at the same time, this type of airbridge ensures that the location of the stand for a

particular aircraft type will not be changed frequently. If there is a need, the hydrant may be repositioned by several metres over night, if the work is well organised.

Another possibility is the so called 'free ramp concept', where a hydrant system is installed without any elements of it being under the apron. Refuelling is provided directly from delivery points built into the airport apron, which are mounted flush with the level of the apron when not being used. An example of such a solution is at Stockholm-Arlanda airport (see Chapter 9).

At airports with a density of operations up to 5 million passengers per annum, the decision to be made between tankers or a hydrant system is often not simple. The investment costs of constructing the hydrant system may differ even between different locations on the same airport, depending on the extent of the system and the possibility of construction in stages. Consideration should be given to the following:

- length of the distribution piping
- building works, including embedding of the distribution system under the apron, taxiways or runways
- number of stands
- pay-back period.

The investment costs of constructing a hydrant system are several times higher than those of a purchase of several tankers. Nevertheless, its operating costs are lower and its service life longer. When projecting and constructing a hydrant system, it is necessary to ensure a high quality of works and materials because the costs of repair, reconstruction, or removal of the consequences of an environmental accident under the apron may be several times greater than the increased costs during the construction.

Even though a hydrant system of fuel distribution has been constructed in the airport, it is necessary to have available several tankers in case of failure or maintenance of a part of the hydrant system, so that fuel can still be supplied to the aeroplanes in aircraft parking stands, in hangars (for engine test), and for drawing the fuel off from the aeroplanes if there is a need.

In summary, the main advantages and disadvantages of hydrant systems are:

Advantages:

- higher fire safety
- higher ecological protection (lower probability of fuel escape and spilling)
- smaller area required during technical servicing of aircraft

- smaller area required for parking of dispensers in the vicinity of the apron
- lower operating costs at high volumes of fuel supply
- lower demands for labour
- easier to ensure high quality of fuel
- aircraft may be very quickly refuelled with any quantity of fuel
- lower demands for maintenance
- reduction of traffic on the service roads.

Disadvantages:

- higher investment costs
- the aeroplane should be accurately parked on the stand
- low flexibility
- high costs of repair in the event of a failure of the system
- in any case need for several tankers to be available.

10.4 SAFETY OF THE REFUELLING OPERATION

Aircraft kerosene has a high concentration of harmful substances and high degree of flammability (class II). During the construction, operation and maintenance of a fuel system, adherence to the standards and set procedures should be ensured so that water cannot be polluted with fuel and so that humans and property cannot be harmed in the event of a fire.

10.4.1 Ecological Damage

Even small leaks, or spilling of fuel during refuelling may have the same serious consequences as a bigger escape of fuel after a failure of the equipment. Small escapes are more frequent, and more easily escape detection, but their effect is cumulative. Also, a small quantity of fuel contained in water can lead to significant levels of pollution, considerably lowering the quality of water and thus reducing its usability.

Fuel escapes may occur in four places:

- during transfer to or while stored in fuel stores
- from distribution piping

- during refuelling
- in hangars during aircraft maintenance.

Then fuel may get into water by one of the following ways:

- by rain drainage into surface waters
- by sewage conduit into a water treatment station
- by infiltration into underground waters.

Fuel most often gets into the rain drainage after an escape of fuel on the apron. Aircraft kerosene is a poisonous substance and its most noticeable effect is in watercourses. After an escape of fuel, fish and other aquatic animals and aquatic plants are weakened by direct toxic effects of aircraft fuel and perish as a result of a deficiency of oxygen which is consumed as the microbes degrade the fuel.

Installation of a separator of oil products in the drainage branch from the apron, or in other parts of the drainage system, is a constructional measure taken to limit the fuel escapes through rain drainage channels. In some cases, the sewer discharges out at a retention tank serving among other things for retention of storm waters. In the event of an escape of fuel, the drain from the tank may be plugged, the layer of fuel may be withdrawn from the tank surface, and water may be treated before being discharged into a watercourse.

The simplest operational measure is to clean up fuel leaks during refuelling *in situ* by sprinkling them with an absorptive substance. After absorption, the residue is carried away and the fuel is burnt off in a specified place or in a special furnace. Special absorbant textiles, which are able to absorb up to 20 times their mass, are most suitable for removing the spilled fuel. It is simpler to remove the fuel with them than with loose material.

When greater quantities of fuel are spilled, some airports use special suction sweepers for removing the fuel. At Manchester airport, fuel is washed away with a large quantity of water into the sewerage drain, and later treated in a retention tank. The surface of the apron is thoroughly cleaned with a detergent. Detergent must not get into the sewage system, because the emulsion that would be created with water and fuel cannot be removed in the retention tank.

An effective way of reducing the number of cases of fuel spilling and to improve the discipline of handling agents providing aircraft refuelling is to invoice them with the costs connected with cleaning up.

Fuel escapes are often caused by the poor condition of the equipment. Therefore regular, visual inspection and scheduled maintenance are essential. Another preventative measure is to prohibit

execution of aircraft maintenance and repairs on the apron, except cases of removal of failed aircraft, and permit them only in hangars, which are equipped with efficient separators.

Fuel may get into the sewage drains after leaks from aircraft in hangars and workshops. If collectors of oil products are not checked and cleaned on a regular basis, they cease to perform their function. If fuel gets into a water treatment station, it may disrupt the quality of the biological function of the station and disable it. Measures to prevent fuel escapes into a water treatment station are similar to those in the case of rain drainage.

When underground storage tanks or installations are damaged, or after a fuel escape on unsealed surfaces, fuel leaks into underground waters. Then it creates a layer on the water surface. New building regulations should prevent such an eventuality. However, there are still many installations that do not comply with the regulations. The solution then is for the affected area to be surrounded by drill holes from whence the polluted water is continuously pumped out and treated. In addition, monitoring drill holes are established, from whence samples of water are taken. There is a disadvantage that by pumping, the level of underground waters drops, having an unfavourable impact on vegetation. Another solution is separation of the affected area by insertion of a plastic membrane at a depth of 30 m, or by partitioning off by ramming in steel walls. Then cleaning is performed only within the defined section. However, in any case, the state of the underground water is worsened

It is often difficult to detect a fuel leakage from the underground storage tanks or from the fuel piping. In spite of the fact that the majority of big airports have established a system of monitoring of fuel escapes by means of drill holes, it gives only an identification of the consequences of the fuel escape. Marking substances may be utilised for an exact localisation of a failure and fuel escape. In the majority of cases, they are volatile materials which are added to the fuel. After several days, the place of damage location may be identified by means of a sensitive gas chromatograph. Since the marking substance has been used for locating the leak, the results are not distorted by any preceding pollution of land.

At some airports, the fuel system is periodically subjected to a pressure test. For example, at Frankfurt airport, the fuel system is taken out of service for one hour every night, and each section is separately pressured. A contingent drop of pressure is evaluated, and on the basis of the test results the maintenance of the hydrant system is executed. A disadvantage of this manner of testing is that a variation in temperature provokes a change in pressure, which may result in a false alarm.

Another way of assessing pipe leakage is used at the stage of performance tests. Very accurate flow meters are installed in each section of the piping to measure the quantity of fuel at inlet and outlet from the respective section. The results are compared, and if there is a difference, an alarm

is put out.

At each airport a plan should be elaborated for the event of an oil accident which all service personnel must be acquainted with. The plan shall contain not only procedures of catchment and removal of escaped material and removal of polluted earth, but also preventive measures to be taken to prevent an oil accident.

In some countries (e.g. USA), stringent limits of atmospheric emissions have been set by the regulations for environment protection. Among them, the contents of unburnt hydrocarbons have been regulated. The unburnt hydrocarbons may get into the atmosphere even during aircraft refuelling. Therefore on some airports, the vapours from aircraft tanks are drawn off and treated.

10.4.2 Fire Safety

A danger of fire during refuelling results from the combustibility of fuels. Aircraft gasoline is ranked among the Class I inflammables (the highest rank) and aircraft kerosene into the Class II inflammables. The prescribed provisions to protect against fire are related to that ranking. Among the passive ones is the extent of safety protective areas adjacent to the stores of aircraft fuels. Their size differs depending on the volume of storage tanks, their construction and the kind of stored material. The active measures prescribe the fire equipment, kind and quantity of extinguishing agents, procedures for fire fighting in compliance with the fire order in force.

Combustion of fuels may occur not only on contact with fire or with a material at high temperature, but also from a static electricity discharge created either from the movement of the fuel in the aircraft tank during the fuelling process, or its accumulation on the surface of aircraft or vehicles. Therefore all parts of the fuel system must be provided with bonding and must be grounded. During aircraft refuelling, bonding should be provided also between the aircraft and the tanker or hydrant.

It is essential that the aircraft be fully restrained and that there should be a clear path for the bowsers to move away if an incident was to occur. Fuel zones should be established 6 m around the fuel vents. There should be emergency stop buttons on hydrant stands and no vehicle should be parked in front of it. There should also be an emergency phone at the head of the stand, and a person nominated as responsible for the fuelling operation. If fuelling is to occur while passengers are on board, the passengers should be told, the emergency exits should be kept available, and non-essential vehicles should be kept off the apron. If there is no airbridge, steps should be positioned both at front and rear doors, and the doors should be constantly manned. Some aircraft have fuel systems which allow fueling the tanks through more than one fuelling point simultaneously. This usually requires fuel equipment to be positioned on both sides of the aircraft which increases the

risk in case of fire.

Organising an intervention when a fuel escape occurs is usually within the competencies of fire brigades. They have both the required equipment and the required experience, they are able to assess the situation also from the viewpoint of the risks of possible fire.

10.5 AIRCRAFT FUEL - FUTURE TRENDS

It may be contemplated that aircraft kerosene will continue to be the most used aircraft fuel for at least the next 30 years. The assumptions that the crude oil reserves would soon be exhausted, which were made during the first oil crisis, proved to be unfounded. In the event that the crude oil reserves do eventually become exhausted, aircraft kerosene may be produced synthetically from other sources without a need to change the airplane design concept. The debate on global warming may accelerate a change away from kerosene to hydrogen. Because the same amount of energy requires four litres of volume in the case of liquid hydrogen, compared with just a single litre of kerosene, the larger volumes of liquid hydrogen would require changes in the configuration of the aircraft. Also tanks for liquid hydrogen have to be either spherical or cylindrical in shape. Tanks on top of the fuselage are a possible solution for big passenger aircraft in the future. The use of cryogenic fuels might be limited to supersonic aircraft with a speed over twice the speed of sound.

Thanks to incremental improvements in engine design, the consumption of aircraft kerosene will continue to increase more slowly than air transport traffic. Such growth will alleviate problems in providing the quantities and rates of fuel supplies into aircraft.

In reconstruction or construction of large airports, there will be a tendency prevailing to install modern hydrant systems. In small commercial airports, aeroplane refuelling from tankers will continue to be the most frequent solution.

A system of collection, transmission and processing of data on aeroplane refuelling is used at some airports. The monitoring system ensures a data collection and evaluation so that after refuelling a basis for invoicing may be available, or an invoice directly issued. Besides the fuel quantity, the modern computer equipment monitors also other parameters, such as fuel temperature, and automatically determines the total weight of fuel supplied into the aeroplane.

11

CARGO

Bob Caves¹

11.1 INTRODUCTION

Cargo, and particularly mail, has been moved by air for as long as passengers. The first official mail flight was from Frankfurt to Darmstadt by Lufthansa on 10th of June 1912.

By 1933, mail was being flown across the North Atlantic by flying boat with a mid-ocean stop for fuel, the aircraft being hauled on deck and catapulted off [36]. A few years later, a more ingenious method of a multistage vehicle, the Short-Mayo composite aircraft, was tested. The mother flying boat took the piggy-back aircraft part of the way across, then launched it to complete the trip with the mail while the mother ship turned back. Many of the major air routes, domestically and internationally, were cemented by mail subsidies between the two world wars.

The freight element of air cargo started even earlier. A sheep, a cock and a duck were flown in a Montgolfiere balloon in 1783 at Versailles. The first transport of freight with a fixed wing aircraft occurred when a 30 kg bolt of silk was flown the 105 km from Dayton to Columbus, Ohio in 66 minutes in 1919.

¹ This chapter is based in part on an MSc thesis by Stewart Walsh, now with TPS Consultants. The authors would like to thank him, and also Bill Blanchard of East Midlands airport and Natasha Lazzari of DHL for their help and advice.

Table 11-1 Freighter aircraft

Aircraft	MTOM [kg]	Max payload [kg]	Main deck vol. [m³]	Wing span [m]	Doors
Boeing B737-300QC	56,470	12,270	120	28.88	Side
Lockheed L-100-30	70,310	23,440	127	40.4	Rear
Boeing B737-700C	77,560	18,780	120	34.32	Side
Boeing 727-200Adv F	83,830	21,180	137	33	Side
Boeing B757-200F	113,400	39,690	187	38.05	Side
Airbus Beluga	155,000	47,000	1,400	45	Nose
Airbus A300-600F	165,110	54,750	265	45	Side
Boeing B767-300F	185,070	54,890	336	47.5	Side
DC-10-30F	251,750	69,850	371	50.4	Side
Boeing MD-11	273,070	93,170	443	51.5	Side
Boeing B777F	347,450	103,900	518	64.8	Side
Boeing B747-200C	356,080	100,010	503.1	59.64	Nose, side
Boeing B747-400F	362,880	112,900	604.1	64.44	Nose, side
Antonov 124	392,000	120,000	750	73	Nose, rear
Boeing B747-800F	435,456	140,000	689	68.5	Nose, side
Airbus A380F	590,000	150,000	945.8/*	79.8	Side
Antonov 225	600,000	250,000	950	88.4	Nose

Sources: *Manufacturers' web sites and www.freightersonline.com, adapted by the authors*

**/ Main deck, upper deck and lower deck*

There followed a phase when IATA set freight rates on international routes. The freight was carried mostly on the basis of available capacity, passengers always being given precedence. There were many aircraft designed specifically for the freight market, often with an eye to the military market, both prior to and following the Second World War (e.g. Bristol 170, A W Argosy with front loading, CL 44 with tail loading). However, it was difficult to make enough money with all-freight aircraft to cover the initial cost of new aircraft.



Figure 11-1 *Front loading reduces the handling costs (Photo: Courtesy CSA Cargo)*

These days, mail and freight has to pay market rates, but the market has continued to grow strongly as shippers take advantage of speed, cheaper packaging, higher safety and security of a shipment and lower insurance premiums to counter higher rates. The available capacity has grown as wide-body aircraft have appeared with surplus belly-hold capacity after loading passengers' bags (e.g. Boeing 747, 767, 777; Douglas DC 10; Lockheed 1011; Airbus A300), and as all-freight versions of passenger aircraft have been developed (e.g. A 300; Boeing 757, 767, 777; Douglas DC 8), usually with side-loading, but also the A300-600 and Boeing 747F with front loading (Figure 11-1), reducing the launch cost to manageable proportions. A list of representative freight aircraft is given in Table 11-1. A further option is to use Quick Change versions of for example the Boeing 737, the seats being taken out at night or at weekends and

the aircraft used to carry containers which are rather shorter than the conventional containers for narrow-bodied aircraft.

Even though there is this impressive range of available freighters, more than 60 per cent of world freight is taken on passenger aircraft. The advent of the A380 with its relatively small belly hold capacity may further increase the demand for all-freight aircraft, particularly as freight traffic is growing more quickly than passenger traffic in the developed world. Rates are no longer controlled by IATA, and are determined by route and demand characteristics as well as by competition. Often demand is strong in one direction, allowing good revenue and the possibility of reduced rates for the opposite direction.

Some major international (legacy) carriers have strong freight contributions to revenue and to profits, while others in different markets have only weak contributions. There is no agreed standard for cost allocation between passengers and freight. Those allocation methods that work on payload weight are unlikely to be as helpful as a revenue management system that takes account of passenger bags, no-shows, surcharges and actual rather than published rates.

Some low-cost carriers realize significant revenues by emphasizing express shipments and/or by contracting with other airlines to handle their lower-hold space. However, the demands of passenger focus and operational efficiency (e.g., quick airplane turnrounds) reduce the priority of cargo. Some LCC ignore the cargo market completely and focus fully on the passenger transportation.

A growing proportion of world trade is now taken by air, and an increasing proportion of that is performed by the integrated, or express, carriers. These carriers offer an integrated door-to-door service with a guaranteed pickup and delivery time, relieving the customer of any direct involvement with customs and providing a tracking capability that allows the customer and the government inspection services to keep track of the shipment throughout the process. They mostly take shipments of less than 100 kg, but each of the four major players offers truly global coverage through intercontinental gateways, sub-hubs and fleets of delivery vans. Fedex, for example, delivers 3.2 million packages per day through 50,000 drop-off locations in more than 220 countries, using 671 aircraft, 41,000 vans and 138,000 employees.

The combination carriers (i.e. those catering for both passengers and freight) generally do not have such weight restrictions. They also offer a global product through their alliances and are also moving more towards an integrated product themselves. Shippers and freight forwarders now have a plethora of options from which to choose. It is quite common for integrators to use space on combination carriers and vice-versa. There are also airlines that specialise in heavy lift, using small fleets of unique aircraft like the AN 124 or the Mil 10 helicopter.

The freighter ‘wet-lease’ airlines (an arrangement that includes all facets of operating an aircraft on a carrier’s behalf, including the airframe, crew, and most, if not all, of the aircraft-related costs), or an aircraft, crew, maintenance, and insurance (ACMI) airline, satisfies important market requirements. It offers airlines flexibility to contract for air transportation services on a trial basis where demand is uncertain, or to augment existing markets, and/or to provide service in markets that are highly seasonal without an investment in dedicated equipment. ACMI services are offered for all freighter sizes, but most growth since the late 1990s has been in long-haul, intercontinental widebody freighter markets.

11.2 THE FREIGHT INDUSTRY’S CHARACTERISTICS

Most of the products shipped by air fall into one of four categories:

- economically perishable goods
- physically perishable goods
- items for emergency maintenance
- strategic inventory management.

Efficient inventory management calls for ‘just in time’ lean manufacturing or quick response to consumer needs as in the fashion industry. There is also increased use of global outsourcing. Their supply chains need to be agile to change the type, the volume and the mix of product in short time frames.

These business trends have driven the growth of air freight, particularly the integrated carriers, and are expected to do so in the future, because they require overnight delivery whereas the combination carriers’ schedules are more determined by the needs of passengers to travel by day. The trends also tend to reduce the ratio of value to weight, but the aircraft loads are still generally more limited by volumetric capacity than by weight limits. However, there are increasing risks to the supply chain in adopting these techniques from disruption in the logistics chain, in addition to problems at the plants, natural disasters, terrorism, etc. Carriers need to have a strategy in place for physical and electronic network redundancy and to work together with their customers on appropriate contingency plans [2].

Worldwide there were 1790 freighter aircraft in 2005, 50% being standard body, 23% medium widebody and 27% large. IATA forecasts that from 2005 to 2009 freight will grow faster than passengers in almost all markets, the fastest growth being China with 14.4 %, the slowest being on the North Atlantic with 4.6%. Boeing predicts that worldwide air cargo will grow at 6.1% per annum while trade grows at 7.3% to 2025 [26]. This will require some 1770 additional freighters, more of which will be in the medium and large categories. Much of this

requirement will be met by converting older passenger aircraft, but there will also be a need for 700 to 800 new widebody freighters. The Asia-Pacific region will take more than a third of the extra aircraft and the capacity. North America will take more than a quarter of the capacity but over 40% of the aircraft.



Figure 11-2 Importance of cargo operation security is constantly growing
(Photo: Courtesy of CSA Cargo)

The transport is provided by the four main alliances of combination carriers and four main integrators (DHL, UPS, TNT and Fedex), together with several independent smaller specialist carriers like Cargolux and Air Foyle. The freight is generated either directly by frequent shippers or through forwarders who consolidate loads. There are some 15 global logistics firms (e.g. AEI, MSAS, Geologistics, Emery) and a large number of small ones. The distinction between these logistics companies and the airlines is becoming blurred as the latter develop their own logistic capabilities and offer value-added elements as part of their customers' supply chain. The traditional logistics companies are tending to merge in response to these threats. The challenge of logistics is getting the right product to the right place in the right quantity at the right time, in the best condition and at a good price.

An essential element in the logistics of air freight is the use of Electronic Data Interchange (EDI). This allows the communication, tracking and tracing of documents by the shippers, the

integrator and government agencies. A shipment may go through up to 40 controlling processes and need 12 to 15 documents. EDI helps to cut out much of this paper trail. Most consignments can be cleared through customs before arrival.

Security has become a crucial area in air freight (Figure 11-2). Frequent shippers/consigners are awarded 'known' status. The validation in the UK is done by independent assessors appointed by the Department for Transport. They check for secure premises, staff that have been through reference checks and are properly trained, access control, preparation, packing and storage of cargo, and transport of secure cargo to approved agent or airline. Similarly agents are given 'Regulated Agent Status'. In the US, the Transportation Security Administration has issued new security rules. All off-airport employees of approved forwarders must have background checks and all employees of cargo airlines must have a full criminal history check. Overseas departure points must have similar provision. All 4000 'known' shippers are to go onto a central database. Secure areas have been extended to include ramps and cargo facilities. Airlines have the right to examine any cargo and its packaging except Post Office mail to check the correctness or sufficiency of information or documents. With some exceptions, all cargo from unknown shippers must be screened, as must all containers whose seals have been broken.

Most of the freight is transported through a few large hubs. This is mostly due to economies of scale and scope, giving keen rates. At airports in South East England, including Heathrow, each worker moves 67 tonnes per year compared with 22 tonnes in the Midlands airports [65]. Although 28 per cent of the air freight flown from Asia to North America in the year 2000 goes direct, almost all of the rest through Anchorage (29%), Tokyo (23%) and Seoul (16%) [204]. In the case of conventional freight carried by the combination carriers this hub pattern is generated historic location of the carriers, by geography and by the facilities at the airports. Time in flight and in transit is most important, a saving of one hour perhaps being worth \$1000 in airport fees. The availability of the entire freight infrastructure (freight forwarders, equipment, customs, etc) is also essential. For the integrators' hubs, geography determines the catchment area within which pickup and drop off deadlines can be met by trucking. The airport needs, in addition to the freight infrastructure, to be free of night restrictions, have available labour nearby at reasonable cost, good road access and, increasingly, the possibility of rail/air connections [125].

Though 2005 was a relatively stagnant year for cargo with only 3% growth worldwide, that was not so in China, which had five of the top 50 airports. Many established passenger hubs not in the top 10, such as Chicago, Heathrow and Amsterdam also stagnated, while small airports in Eastern Europe showed strong growth as the countries obtained inward manufacturing investment (e.g. Samsung and Kia in Slovakia). However, in the previous year cargo at London airports had increased by 8 per cent. The traffic was split evenly between

uplift and set-down and between UK and foreign airlines, about 5 per being mail [33]. Seventy seven per cent of the cargo was on passenger aircraft, partly due to the ban on freighter flights at Heathrow in peak hours and to severe night time restrictions.

The top ten cargo airports in the world in 2005 are given in Table 11-2.

Table 11-2 The top 10 cargo airports

Airport	Throughput [mil. t/year]	Growth 2004/2005 [%]	Leading carrier
Memphis	3.599	1.2	Fedex
Hong Kong	3.437	10.0	Cathay
Anchorage	2.609	9.7	Fedex
Tokyo Narita	2.290	3.5	JAL
Incheon	2.150	0.8	Korean
Frankfurt	1.963	6.7	Lufthansa
Los Angeles	1.929	1.4	Fedex
Shanghai	1.856	13.7	China Eastern
Singapore	1.855	3.3	Singapore
Louisville	1.815	4.3	UPS

*Source: Air Cargo World, July 2006, adapted by the authors
(NB: slightly different data are given by Airports Council International)*

In the light of the industry's characteristics and growth expectations, as described above, it is clear that the facilities at airports need to be developed to provide for efficient, effective and economic operations. At the same time, they must meet the required standards in terms of the environment and sustainability. Carriers are constantly searching for locations where the environmental and operating constraints may be minimised: DHL moved its main hub to Wilmington only a year after making a \$220 million investment at Cincinnati partly for better runway capacity, and is moving its main European hub from Brussels to Leipzig partly due to

environmental restrictions. The design of airside, terminal and landside facilities will now be examined, bearing in mind these industry needs.

11.3 AIRSIDE DESIGN CONSIDERATIONS

The taxiway system should be free of capacity bottlenecks and minimise the in and out distances. The requirement is more important for integrator hubs, where many aircraft arrive almost simultaneously at night. This also requires runways to be aligned so that the arrival and departure routes avoid major centres of population and for taxiway routes to avoid directing engine exhausts towards the community. There should be unimpeded access to the freight apron.

The apron needs to have the capability to park all the all-freight aircraft likely to be on the ground at the same time, unless the maintenance or passenger aprons are close by and are likely to have spare capacity at the time of the freight operations. It is often approximately five times the plan area of the terminal. Freighters operating conventional cargo service tend to spend longer on the ground than integrator or passenger aircraft, up to seven hours. Considerable flexibility should be built-in for growth in the size of aircraft: once a pattern of freight routes has developed, it is more likely that traffic growth will be by frequency and size of aircraft rather than by additional routes, particularly in the case of the integrated carriers.

The aircraft should be parked as near as possible to the freight terminal in order to reduce the amount ground traffic movement. This is essential if loading bridges are to be employed, though this normally only happens with nose-loading B747 operations. The freight transfer devices require a well-marshalled airside road between the terminal and the apron. The greater the percentage of contact stands, the less the need for other airside roads and the potential for accidents.

There should also be sufficient space for storing all the handling equipment and Unit Load Devices (ULDs). ULDs come in a large range of sizes and types, from 606 x 244 x 244 cm to 156 x 153 x 163 cm, some are rectangular, some are contoured to the shape of the fuselage, some are rigid, some are netted pallets, some have environmentally controlled interiors (see www.freightersonline.com, and Figure 11-3). At the same time, it should be borne in mind that aprons are expensive to build because they are designed to support the standing loads from aircraft at their maximum weight, while most of the ancillary equipment imposes considerably lighter loads.

The ULDs are taken from the terminal on flat roller-bed dollies and loaded onto the aircraft main deck or belly holds using high-loader (Hi-Lo) vehicles fitted with driven roller beds.

Once inside the aircraft, they are transferred to roller beds on the floor of the aircraft, having been loaded in the correct order to achieve the necessary balance. Bulk cargo is loaded manually into the belly holds, having been brought in carts to the apron by tug and transferred to the aircraft door by self-powered conveyors (see Figure 11-4).



Figure 11-3 *Contoured ULDs on roller-bed dollies (Photo: A. Kazda)*

The specialised cargo handling equipment (e.g. Hi-Lo, see Figure 11-3) is very expensive and needs trained drivers. A careful balance needs to be struck between saving by sharing the equipment with the passenger apron or with other handling agents, and the possibility of letting the level of service slip below acceptable levels.

There needs to be enough artificial light on the apron to read documents, labels and placards, for the safety of the ground personnel while working in the midst of moving ground vehicles and aircraft servicing activity. However, it should not be so bright as to make it difficult for the flight crew to manoeuvre the aircraft.

There is a lot of movement of cargo between the passenger and cargo aprons at most airports. It is therefore good practice for the distance to be kept as short as possible, within the framework of the airport's master plan. An airside road connection of sufficient capacity should be provided, with the capability support 10 tonnes per axle, 12 metres wide, a maximum of 4% gradient and a minimum turn radius of 20 m.



Figure 11-4 Bulk loading cargo into a belly hold (Photo: A. Kazda)

11.4 TERMINAL DESIGN AND OPERATING CONSIDERATIONS

11.4.1 Location

The air cargo terminal is a critical part in the air cargo supply chain. An inadequate air cargo terminal concept that is unable to accommodate the peak volumes of cargo may result in delays, while a concept that is not flexible enough to meet the changing demand may soon become obsolete during its service life.

A conventional freight terminal should be located as close to the passenger terminal as possible, commensurate with master planning indications to extend the facilities, and with

geotechnical site constraints: earth-moving, drainage, utilities, etc. A terminal for an integrator should, in contrast, be separated as far as possible from other facilities unless there is likely to be substantial cross transfer with the combination carriers. Many integrators prefer to be on the opposite side of the runway, with their own taxiway system. The freight terminal should also be as close to the runway as possible, without infringing on any of the runway transitional surfaces, either from the building or from the tails of parked aircraft. Nor should it give rise to reflections that might threaten the integrity of the electronic guidance systems.

11.4.2 Design parameters

The design of the terminal itself and the equipment with which it is fitted depends on:

- the type of operator and their service standards
- the expected rate of growth of demand and the ultimate capacity required
- the political and economic setting
- the airport and local authority planning constraints.

Conventional freight terminals may be used by a single airline (usually the based operator) or forwarder, or by several different companies each with their own sections of the building. This latter option clearly gives a more competitive market and creates more revenue for the airport as landlord. However, it causes duplication of the materials handling equipment, takes more space and increases the initial cost. Integrators usually construct and operate their own terminal. Their traffic usually consists of packages less than 30 kg and courier mail. Activity is very peaky, and the dwell time is less than with conventional freight. Target service standards also help to determine the staffing and facility requirements. Typical standards may be:

- consignments available for collection, examination or transhipment three hours after arrival
- cleared consignments available within 15 minutes of consignee arriving at import collection point
- customers to wait not more than 30 minutes after arrival for collection at truck dock
- cargo reception to be complete within 30 minutes of arrival at truck dock.

The level of demand for conventional freight depends on the freight tariff, the time spent in transit, the frequency and timing of services, as well as the economic characteristics of the region. Further, the future type of traffic is important: the domestic/international split, the in/out/transfer split, the freight/mail split, seasonal fluctuations, daily and weekly peaking, special handling needs for heavy items, outsize items, perishables, dangerous goods, livestock,

urgent goods. Most importantly, it is necessary to know whether the freight is to arrive and depart in bulk or on pallets or in small or large ULDs, and if the ULDs can be loaded direct from trucks that will be given access to the apron.

The political and economic setting will largely determine the availability of labour of differing skill levels and their rates of remuneration, as well as the life cycle costs, the availability of spares, the performance level of equipment and staff. There will be policies on airport ownership that will determine the degree of commercial practice both on the airport, so influencing the dwell time of freight in the building. The border control and security authorities will determine the regulations governing security and truck access to aprons, though aviation's governing bodies are attempting to harmonise matters of security and safety worldwide. They will also determine the extent to which bonded goods may be allowed to move outside the airport, which in turn will bear on the process of 'known' shippers and the possibility of allowing some handling off airport, e.g. stuffing of containers.

Planning guidance from the airport or the local authorities might influence the location, the size and the height of the building, and the extent to which the airport activity can grow. It can require compliance with sustainability objectives for the building and its power consumption. It can also influence the mode of ground access through road building and modal shift policies.

11.4.3 Mechanisation

All the above factors contribute to determining the level of mechanisation to be provided for handling the freight. The choice is essentially between:

- manual: manpower plus fork lift trucks
- semi-mechanised: roller beds or conveyors
- fully mechanised: Elevating Transfer Vehicles (ETV), Automatic Storage and Retrieval Systems, Transfer vehicles.

A high labour content may mean that costs rise over time, but it is more possible to react flexibly to demand peaks. The fully mechanised approach only really works with high volumes of containerised freight and in a setting that can guarantee good maintenance skills. Even so, the whole terminal can come to a halt if an ETV breaks down. ETVs work up to seven metres high with hydraulic or electric chain drive. They are only applicable if there is a need to store a large number of ULDs over three decks. British Airways, at its multi-level World Cargo Centre at Heathrow, prefers lifts and lowered roller conveyors so that there are more options in case of breakdown. Transfer Vehicles are powered roller conveyors mounted on a carriage with bogies which are electrically driven along rails in response to a command system.

Mechanisation is much more expensive in terms of first cost, but reduces the labour requirement, causes less handling damage, less pilferage and there is less risk of mishandling (Figure 11-5).



Figure 11-5 *Storage mechanization reduces the labour costs (Photo: Courtesy CSA Cargo)*

A semi-mechanised terminal may have belt conveyor systems and powered flat roller conveyors where the rollers are chain-driven from the previous one. They will also have reorienting and transfer dock beds: some have wheels that right angles rise up between the rollers, or powered ball decks, or heliroll rotation tables where the different quadrants are powered with a joystick.

11.4.4 Terminal functions and operations

There are five main functions to be performed in the terminal:

- conversion between modes of transport
- sorting, including breaking down loads from originators and consolidating for destinations
- storage, and facilitating government inspection
- movement of goods from landside to airside and vice-versa, or from aircraft to aircraft
- documentation: submission, completion, transmission.

A good terminal will have systems that will allow efficient movement, effective storage, easy sortation, accurate and timely inventory control, tight security and effective use of manpower. Getting everything right can reduce the mis-handling rate from 1 : 20 to 1 : 26,000.

Most freight comes from the shipper by road and leaves the airport by air, but it is not always so. Airlines use trucks with flight numbers instead of aircraft on relatively short haul sectors, and rail is also beginning to be used instead of road as a way of meeting sustainability targets. Also, there is an increasing trend to integrated air/road/rail/sea ports as at Dubai, Sharjah, Seattle. The freight on the trucks may be loose, on pallets, or already containerised. If it is from a 'known' shipper, the truck will have been sealed before leaving the shipper's premises.

Unless there is a full container for one specific destination, the freight is taken out of the ULD or off the pallets and sorted by aircraft flight destination. All the freight for each destination is gathered together and stuffed into the container(s) appropriate for the aircraft being used. The same process applies to freight arriving by air for transfer to another aircraft, except that it comes into the terminal from airside rather than landside. The breakdown and stuffing is an entirely manual process, regardless of the degree of mechanisation in the terminal. It is good ergonomic practice to have height-adjustable platforms at the work stations. The platforms may also indicate the weight and sometimes the stability of the ULD. This information is vital for the correct loading of the aircraft.

Storage is needed mostly for incoming freight which is awaiting clearance or collection following inbound clearance, but also for inbound freight before breakdown, outbound freight awaiting consolidation or stuffing or awaiting departure, and transshipments. Collection can be a matter of an hour or two, but may, in some countries that have no strict policy for charging for it, extend to weeks as companies use the terminal as free storage. Typical times in the developed world are 20 hours for export, 40 hours for import and 32 hours for transshipment. Traditionally, goods take six days from shipper to receiver. Approximately 90 per cent of this time is spent on the ground. Transport accounts for 12 per cent of this time. The rest can be considered as delay, largely due to waiting for documentation to be completed due to lack of resources or information, or inaccurate delivery instructions, or problems with customs clearance. ULDs vary in height from 1.7 m for lower deck, through 2.4 m for the main deck, to 3.0 m for fully contoured, these dimensions determining the rack spacing required for storing them. Consignment storage is usually in one metre cubes of racking fed by fork lift or by automatic storage/retrieval systems as employed in supermarket warehouses. They may extend to 20 units high by 30 long by 14 deep, to give 1000 cubic metres. Both inbound and outbound freight may be subject to inspection by government agencies for contraband, drugs, illegal immigration, weapons, etc. Storage is much less necessary in integrators' terminals, where the freight arrives only just in time for onward shipment and where almost all of it will have been pre-cleared though the EDI. Empty ULDs are often stored outside.

Goods are usually moved from trucks into the terminal by trains of carts carrying bulk freight, pallets or containers pulled by tugs, preferably electrically powered. They are then manually off-loaded onto conveyers or taken by fork lift to be sorted by destination. Either the sort process deposits the goods directly at the stuffing platforms or they are again taken by conveyor or fork lift to the platform. The conveyor system for moving the goods inside the terminal can run to many kilometres in length. It is usually mounted high up to allow free movement of fork lifts and ULDs at ground level. Packages up to a maximum of 30 kg are put into trays on the conveyers. The filled containers are then moved to the airside dock designated for the aircraft by a system of roller beds, or omni-directional ball-top beds if there are changes in direction involved. In the reverse direction, a similar process of movement occurs, except that the trucks back up to doors in the terminal so that they can be loaded directly under a canopy rather than having to be fed by tugs or fork lifts.

11.4.5 Documentation

The consignments and their associated documents flow through parallel channels, closely tied together. The relationship is indicated in Table 11–3. The paperwork has traditionally been passed through four separate systems:

- Cargo Movement Control (CMC)
- Data and Documentation Flow (DDF)
- Cargo Community System (CCS)
- Management Information System (MIS).

CMC basically carries information about the status of the cargo within the terminal: what form, where, stage of processing. The information comes from manual input to a PC or from reading bar codes. DDF generates the Air Waybill and enters it in the airline's reservation system. The CCS for the terminal integrates airport data with that from carriers, forwarders and the control authorities, with a link to customs. MIS maintains overall integration, stratified so that, for example, senior management can review commercial results and access all data, while the operations staff can access short term data like expected schedules and load balance status.

The industry is now moving towards an Electronic Data Interchange System (EDI), shown schematically in Figure 11–6, that links all these separate systems together.

Table 11-3 The flow of consignments and documents

Documents	Action	Goods
Inbound		
AWB/Manifest to cargo office Check for completeness of documents	Airline	To bonded reception Numerical check
Sorting and distribution of AWBs and Manifest copies (import/transfer)	Airline	Breakdown and segregation of import and transfer cargo
Issuing of Transfer Manifest/customs documents (in-bond document, etc)	Airline/ Customs	Transfer cargo conveyance to proper place (export section/other airline)
Completion of AWBs with Customs/Airline (rotation no, flight no and date)	Airline/ Customs	Physical check (identification of import goods against doc. (Manifest/AWB/copy Load Sheet/Customs list)
Sorting of AWBs for processing (Brokers/Special cargo, etc) Notification to Consignee/delivery of AWB to Broker	Airline	Storage/packing in bonded area according to Consignee/Broker and nature (special cargo, perishables, cold storage, etc)
Preparation and filling of Entry forms with Customs examination (sampling system)	Broker/ Airline/ Customs	Conveyance of selected items to Examination area (sampling system)
Release check/stamp Preparation of documents for delivery	Airline/ Customs	Customs release check. Withdrawal of goods from bonded into Cleared Cargo area/delivery to Consignee, reforwarding.
Outbound		
Letter of Instruction/Export Declaration (licence, etc)	Shipper	To Agent or to reception area of airline's warehouse
Issuing of AWB/completion of Export Declaration	Agent/ Airline	Checking of weight/packing/labelling
Clearance Processing of Export Declaration/examination (sampling system)	Customs/ Agent/ Airline	Customs Check Point for area Airline's Acceptance Check Point (if received from agent) Examination (sampling system).
Check and final completion of AWB (Routing/bookings/special cargo). Distribution of AWB copies	Airline	Assembly in warehouse according to flight/destination
Final release to appropriate Flight/completion of Manifest/running off copies	Airline	Loading area tally against Manifest/Load List and assembly on carts/bins/pallets.
Preparation of flight documents AWB/Manifest copies: (a) for customs file, (b) for ship's bag on board	Airline/ Customs	Conveyance to aircraft. Customs supervision (load check).

Apart from cutting out a great deal of paper, it should allow:

- electronic acceptance of all Air Waybills
- utilisation of bar codes to identify and track all freight through its journey
- electronic capture and transfer of Air Waybills through customs for faster clearance
- full availability of status for all customers
- ‘carriage ready’ presentation of all freight and documentation.

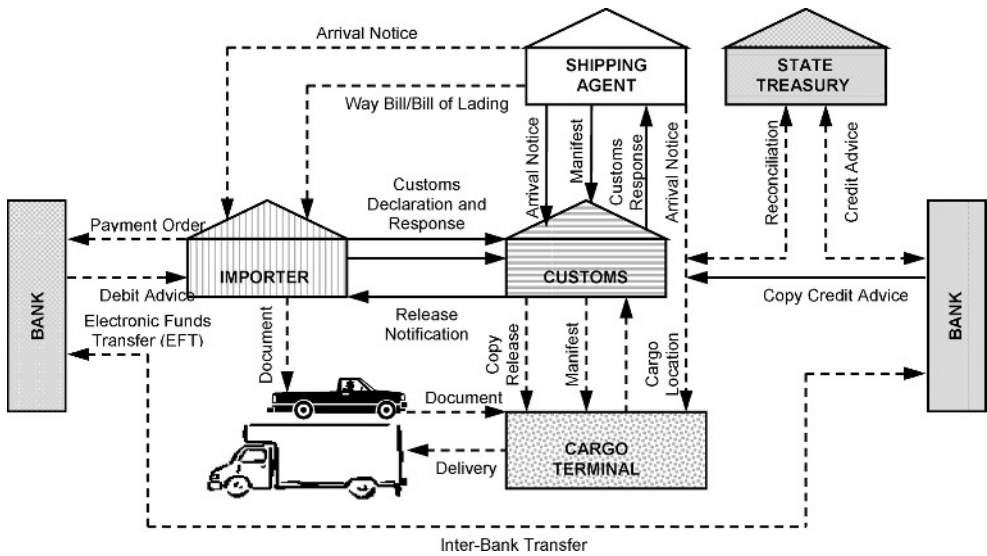

Figure 11-6 *Electronic Data Interchange System* (Source: Courtesy Stuart Walsh)

11.4.6 Utilities

The terminal design should take account of the need for a large number of facilities:

- potable water
- electric power, and a standby system, clean for computers
- lighting (200 – 300 lux at floor level, allowing effective colour reading and the use of PCs)
- fire detection and protection
- heating and cooling
- sewage disposal

- garbage disposal
- surface water drains
- lightning protection
- aircraft fuelling and ground power
- communications (phones, computer cables, antenna sites)
- ground to air radio
- two-way personal VHF radio
- public address system
- closed circuit CCTV
- document and message conveyors.

11.4.7 Security

A security system is necessary to protect against theft and, increasingly, to thwart acts of terrorism. ICAO (10) passed responsibility to the freight agents to X-ray screen, search, and hold for 12 hours or depressurise all cargo that is not from a 'known' shipper. New regulations have been brought in, requiring screening of all cargo inbound as well as outbound. Cargo bound for the USA has to be put through a portal on the ramp to detect explosives.

A minimum requirement of a cargo terminal security system will have:

- control of access to staff and visitors
- a CCTV system
- perimeter fencing and lighting, and a road to physically inspect it
- a barrier control system
- background checks on all employees
- explosive detection system.

In addition, it should follow all the guidelines discussed with respect to passenger terminals and the airside (Chapters 12 and 13).

11.5 CARGO TERMINAL LAYOUT AND SIZING

11.5.1 Layout

A notional typical layout is shown in Figure 11–7. Most terminals have only a single work floor, the inbound and outbound freight being processed side by side. Essentially, the flow moves towards the airside from the truck bays through de-stuffing, sorting, transfer, re-stuffing, weighing, screening and out to the airside dock, and vice-versa.

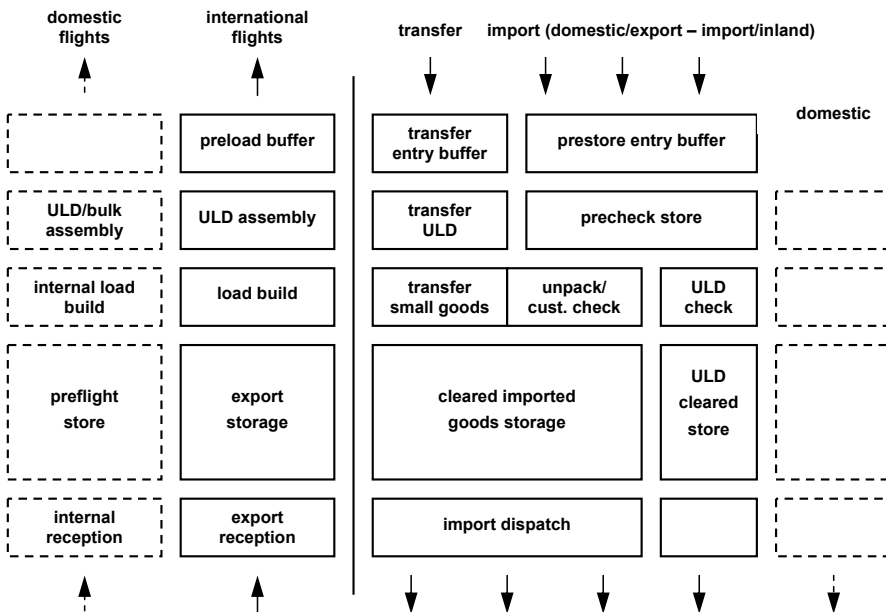

Figure 11-7 Notional layout of a cargo terminal floor (Source: Courtesy Stuart Walsh)

There are separate channels for international, domestic and transfer traffic. The minimum depth required from the aircraft nose to the landside boundary is:

- apron staging area - 18 m
- airside road - 12 m
- unit loading area - 6 m
- terminal - 90 m
- truck docks - 25 m
- landside cargo road - 10 m.

Resulting overall terminal depth is in total of 190 m, plus another 10 m if aircraft are to be loaded through the nose. Columns should be kept to a minimum, subject to cost control. Some of the latest terminals have multi-level processing.

A choice has to be made between handling ULDs either with the short side or the long side parallel with the terminal frontage. The former is good for storage, there are more positions for 20 foot containers, and the build-up positions can be accessed from two or three sides. However, there are fewer build-up positions and a deeper building is required to get an adequate staging area.

IATA recommends that offices requiring direct access to the physical goods should be on the same ground level as the operations, while accounting and other offices should take advantage of the natural height of the building by being on a mezzanine. However, the physical separation between offices can result in dysfunctions. Canopies should be provided over the truck and airside docks.

11.5.2 Functions and facilities

In addition to providing for the actual storage and flow of cargo, the terminal building has to house facilities for a large number of ancillary support activities:

- supervising and control offices
- airline offices
- freight forwarder offices
- customs inspection area and offices
- agricultural inspection area and offices
- security
- operations offices
- administration and support areas
- customer service
- battery charge area
- maintenance and spare parts
- plant room
- computer suite
- staff support

- aircraft spares and tools
- refuse collection.

It will also be necessary to provide special accommodation for a number of special cargos, all with their own requirements:

- vaccines, live organs, medicines - refrigeration
- bullion, documentation - strong room, dedicated 'airlock' type vehicle docks or hopper systems
- human remains - temperature control, mourning area
- livestock - climate control, quarantine, partitioning for species, racking for small cages, veterinary support
- dangerous goods - IATA regulations
- radio-active - shielding or spacing to meet exposure standards
- airmail - secure
- oversize or heavy cargo
- meat, fish, dairy, flowers, plants - all need to be cooled.

Each type of special product needs its own separate work area for ULD build-up, sorting repackaging and quality control. Flowers and fruit need four to six degrees Celsius and 80 % humidity; fish need to be near zero degrees and near 100% humidity.

11.5.3 Sizing

The size of the building is determined partly by the above factors, and also by the amount of freight delivered at one time, the expected dwell time, the density of the freight, the size of equipment, and the role of the terminal. If most of the freight comes in belly holds of passenger aircraft, the flow through the building is less peaky than if it arrives on a 747 freighter. The size of the aircraft determines the maximum unit load size, hence the batch processing size and the size of the load assembly area. The role of the terminal may be transshipment, international entry/exit, originating domestic or international flights, or a mixture of all these functions. The more originating and international freight there is, the more functions need to be performed and hence the larger the building. The cubic capacity of a terminal depends on the design year throughput and the expected seasonal, weekly and daily peaking. It is also influenced by the factors mentioned in the discussion above. The minimum height for processing is five metres, more for automated terminals with high storage racking. It

is customary to install offices on a mezzanine floor above to work floor. Also, there is an increasing trend to use multi-level buildings for the main functions, as space on airports becomes increasingly scarce and expensive (e.g. British Airways at Heathrow, Hong Kong, SATS at Singapore). A survey of some 50 terminals revealed that averages of 0.5 tonnes per year per cubic metre for throughputs less than 400,000 tonnes per year to 1.0 tonnes per year per cubic metre for throughputs of more than 800,000 tonnes per year.

As long ago as 1964, the US Federal Aviation Administration issued an Advisory Circular [113] with a space chart that suggested that 800 m² is needed for processing and a further 150 m² administration for a throughput of 150 tons per day, i.e. a total of 40 tons per year per m². or even 47 tons per m² if the offices are not counted, assuming 250 working days per year. This high level of productivity is hard to achieve. IATA suggests that the figure should vary between five and 17 tonnes per m² depending if the terminal is equipped for low or high automation [151].

The survey suggests that the average spatial productivity is 10 tonnes per year per m² of total area for terminals handling more than 250,000 tonnes per year or 5 tonnes per year per m² for small terminals with 50,000 tonnes per year. The spatial productivity varies from 1.87 to 52 tonnes per year per m², depending on the country, the degree of automation, the type of cargo and the quality of service. Even a manual terminal can be made to produce 40 tonnes pre year per m², but only at a low quality of service and with health and safety being compromised. In terms of operating area, the throughput varies from 6.66 to 20.48 tonnes per year per m². This implies a productivity of 16 to 77 tonnes per year per m² of administration area. It is usual for offices to take 20 to 25 per cent of the total floor area.

Other results of the survey, in terms of tonnes per year, were:

- tonnes per break station: 3,641 – 18,604; average 10,000
- tonnes per bulk storage bin: 38 – 643
- tonnes per ULD storage position: 167 – 783; average 550
- storage positions per ETV: 70 – 600; average 300
- bulk/ULD storage ratio: 0.52 – 13.25; average 3
- tonnes per landside dock: 2,520 – 22,727; average 4,000 for old, 10,000 for new
- tonnes per employee: 307 – 909; average 375 for medium automation
- tonnes per airside dock: 2,778 – 47,273; average 20,000.

The data obtained by the survey are only approximate. It would be preferable for the areas to be broken down by function, and account to be taken of the amount of bypass cargo and apron

storage of ULDs, and some of the processing being done off-site. However, the above results do give some approximate indications of the space required. In general, the higher the degree of automation and the higher the throughput, the greater will be the spatial productivity.

The terminals for the integrated carriers tend to operate at the lower end of the spatial productivity ranges. They do not deal with all the specialised types of cargo, but the cargo is less dense and the daily utilisation is lower due to the peakiness of the demand. IATA suggests that the main integrator hubs manage seven tonnes per year per m², while the smaller facilities can handle about five tonnes per year per m².



Figure 11-8 *Cargo pallet work station (Photo: Courtesy CSA Cargo)*

Airside doors should be 5 metres wide and up to 5 metres high, while landside doors are normally 4 metres high by 3 metres wide. They should be damage-resistant and secure. The presentation of ULDs to the aircraft depends on the aircraft's floor restraint system and its loading doors, and so affects the way the ULDs are organised for transfer to the ground handling equipment. This makes it convenient to have a ball-bed airside dock. The width of terminal doors depends on the presentation angle, as do the widths of the conveyor system's pallet dollies and the truck beds.

The space for each activity within the terminal is dictated by the maximum size of ULD or package handled. Typically, the truck dock loading bay will have scissor lifts or a vehicle that moves along the dock interface capable of handling 5 tonnes, with a width of 3.4 metres and a lift from 0.5 to 1.6 metres. Work stations are usually 3.6 metres long, 2.7 metres wide, lift from 0.5 to 1.6 metres and can support 7 tonnes (Figure 11-8). Reorientation beds and weighing scales will have the same dimensions and weight limitations as work stations. Sorting chutes may be 50 metres long and extend 4 metres either side of a central conveyor belt.

11.6 LANDSIDE DESIGN AND OPERATIONS

The landside traffic delivering or collecting freight consignments includes private cars, flat bed trucks, vans of different sizes, lorries (some with their own handling systems) and special container vehicles. The vehicles need an efficient road access system, with 2 lanes and a total width of 10 metres, preferably dedicated to freight with its own access to the public road system. The access roads should, where possible, avoid centres of population, as both the size of the trucks and the frequent need to move at night can cause problems with local communities. The vehicles also need parking, security checks, docks on the landside face of the terminal, and support facilities such as documentation services, driver rest areas, and fuel stations.

The trucks will often be backed up to individual doors in the terminal for collecting consignments, but may need to be parked adjacent to the terminal when delivering, with the consignments being taken to the terminal by fork lift. The secure area behind the terminal needs to be deep enough to allow reversing to the doors and also for the parking. The angled parking should be 22 metres deep and 35 metres from the loading bay.

Arrangements must be made for the employees to get to work. With the emphasis on minimising the environmental footprint, efforts should be made to ensure there is public transport available. This is a particular problem when most of the freight activity is at night, as with the integrated carriers. An adequately sized car park also must be provided for those who cannot take advantage of bus services.

11.7 FUTURE TRENDS

There is every expectation that cargo will continue to grow at least as fast as passengers, and that the integrated carriers will obtain an even larger share of the market: industry will press for

ever shorter order cycle times and solid state technology will continue to increase. Trends already under way include paperless transactions (EDI), short haul trips by truck, larger aircraft and multi-level terminals. Other probable changes are:

Conventional combination carriers will improve their systems to take advantage of their high frequency services. As logistics companies offer more added value to the shippers, more free zones will be located on airports, as at Beirut and Jakarta, and planned at Athens. The trend to integrated rail /air /sea is likely to continue despite the problem of compatible containers. Sea may take 35 days, air 4 days and sea/air 16 days, and there are many customers for whom 16 days is a comfortable time to tie up inventory in return for rates that are approximately half the air rates.

As land on airports becomes harder to find and more expensive, more aspects of the cargo handling will find its way off-airport, subject to customs allowing bonded transfer, as in Taiwan and Delhi.

11.8 DHL CASE STUDY

DHL is one of the four largest integrated carriers. It is now wholly owned by Deutsche Post World Net, the world's seventh largest employer. DHL was launched in the USA after deregulation. It recently moved its main base to Wilmington, where it spent \$US 300 million on a one million m² terminal to handle 150,000 packages per hour, using 7000 employees, 40 km of conveyors and turning round 115 aircraft per night. It is co-located with DHL Solutions. This has a 91,000 m² warehouse and offices in a Foreign Trade Zone from which it offers pick-up, repair and delivery of PCs, IT, etc.

Worldwide, DHL uses 250 aircraft, a third of which meet ICAO Chapter 4 noise regulations and 29% meet the new CAEP 4 NO₂ requirements. It employs 285,000 people, has 76,000 vehicles, 4000 offices and 120,000 destinations in 220 countries, serves 3.5 million customers each day, and generated revenue of 3.3 billion Euros in 2004.

In Europe, DHL operates 12 hubs. The largest of these is at Brussels, which has 40 aircraft and moved 660,000 tonnes in 2005. DHL is in process of moving to Leipzig in 2008 after a new runway has been completed, partly because of strong environmental constraints at Brussels. The terminal will have a strong emphasis on sustainability: there will be solar panels, combined heat and power plant, rain water will be used for washing aircraft and there will be access to the rail system.

The main UK base is at East Midlands Airport (EMA), second only to Brussels in size. EMA encouraged freight operations after it was privatised, building a large apron and warehouses at the East end of the airport, together with a cargo village to house 25 forwarders. Almost all of the freight is by integrated carriers (UPS and DHL), but there is also a strong Royal Mail hub, a fleet of 9 Boeing 737-300QCs carrying 20% of all Royal Mail flown post in containers sorted in a 4000 m² warehouse on the airport. EMA handled 293,000 tonnes in 2005, making it the main pure freight airport in the UK. Though UPS has a cut-off for pick-up in London one hour earlier than with its Stansted operation, EMA's location is very central, its management style is friendly and helpful, and there is a relatively small number of people annoyed by noise. It has been proactive in using its noise monitoring system to police the aircraft movements. It is the first airport in Europe to adopt the Webtrack system to allow anyone to view the movements on a pseudo radar screen after a delay of 24 hours and interrogate it to find the details of each flight. An independent noise forum meets quarterly. The airport has organised 24 hour scheduled bus services so that freight workers have can get to work from the three cities within 20 kilometres.

The location allows DHL to meet tight pick-up and delivery times to a large part of the UK by truck. DHL invested £35 million in a dedicated terminal in the year 2000, while the airport invested £15 million in the associated 160,000 m² apron on a site at the West end of the airport that allows DHL a maximum degree of independence in its operations. The terminal location required that the ILS beam for Runway 09 be narrow, so Category 3 equipment is in use for all precision landings.

The terminal has a 30,000 m² warehouse and 10,000 m² of offices. Also, there is a 10,000 m² truck canopy for the 35 bays and parking for a further 70 trucks. There are 270 truck movements each night. There is a workforce of 600 people, and a capacity to handle 45,000 packages per hour or 1200 tonnes per night, using 4 km of conveyor belts.

The 18 stands serve 50 domestic and European destinations, together with flights to Wilmington, New York and Hong Kong, each night of the working week. The fleet consists of 3 MD11s (operated by Lufthansa), 7 A300s and 10 B757SFs. All but the A300s are equipped for Category 3 landings. Unlike Wilmington or Brussels, EMA does not work as a pure hub where all aircraft are on the ground at the same time. Many of the aircraft are turned round within an hour. A tight schedule may result in a decision not to use the belly hold capacity because it takes longer to load. Up to 30% of the cargo is O-D, i.e. it is imported or exported. The rest is transferred between flights, mostly entering the terminal for sorting, though some is transferred directly on the apron.

The Flight Control Room has a controller for each of three operations: fuelling, air crew communications and loading/unloading. They have a view of all stands on the apron, though not all of each stand can be seen when the aircraft are parked.

Most of the documentation travels ahead of the cargo electronically, allowing real time tracking of the cargo and virtually all the cargo to be cleared through Customs without physical inspection. It also allows the Network Control Group to match the expected cargo to the aircraft, to switch types to change capacity, contract space on commercial flights and accept cargo from the conventional airlines. They are able to call on a back-up aircraft when necessary for technical or capacity reasons. The group also performs the load and balance calculations for all the aircraft, using a computerised system developed in-house.

Security is maintained with a variety of systems. There are 101 CCTV cameras of very high quality viewing all aspects of the operation. All staff go through a screening process in the administration building attached to the terminal, similar to that performed on passengers. All trucks pass through a security lock where the 'known' shipper seals are inspected and there is X ray equipment for screening any loads that do not conform.

Cargo flows from airside or landside into one area of the terminal. Much of the landside cargo is brought from the trucks in trains of cages. Airside cargo arrives in ULDs. The de-stuffing, sorting and stuffing of ULDs are all manual processes, though some pallets are loaded directly into containers by fork lift. All parcels are electronically reconciled with their proper container, after which the ULDs and pallets are moved on fork lifts or roller beds to the airside or landside doors for loading. Courier traffic is dealt with by a separate belt and automated sort system. The total time to move from truck to aircraft is 75 minutes, and from aircraft to truck is 90 minutes.

Almost all of the DHL flights are during the night, so the terminal has been opened to other freighter operators during the day, thus making better use of all the handling equipment. EMA has reduced rates during the daytime and has advantages in clearance time over the London airports, but the number of forwarders has not increased over time.

12

PASSENGER TERMINALS

Tony Kazda and Bob Caves1

Kauffman's airport law:

The distance from the entrance into the terminal building to the airplane is inversely proportionate to how much time you have to catch the plane.

(A. Bloch: Murphy's Law)

12.1 AIRPORT TERMINAL DESIGN PRINCIPLES

The terminal is often the first point of contact with the country for the arriving passenger. It is a shop window of the country and makes the first and, on departure, also the last impression on the passenger. From the architectural point of view terminals have always been and they still are a show piece representing the best of a particular country. It is, however, necessary to give priority to the functionality of the building by a suitable layout of the terminal and the way it is operated if the passenger is to go away or enter with a good impression. Surveys show that Dubai (< 15 mppa), Copenhagen (> 15, < 25 mppa), Singapore (>25, < 40 mppa) and Atlanta (>40 mppa) consistently manage to give passengers a good experience of moving through an airport. The

¹ The authors would like to thank Keith Polkey, Declan Rajasingam, Paul Boynton and Dave Milner of Heathrow Airport and George Hohlacov for their help and advice.

design of the building depends not only on the number of the checked in passengers but it must also have regard for the type of the airport operation, in particular whether the airport is predominantly an airline hub or is serving mostly local point to point traffic. The basic design characteristics of terminals can be found in the literature (Ashford and Wright, 1992; Blow, 1996; de Neufville and

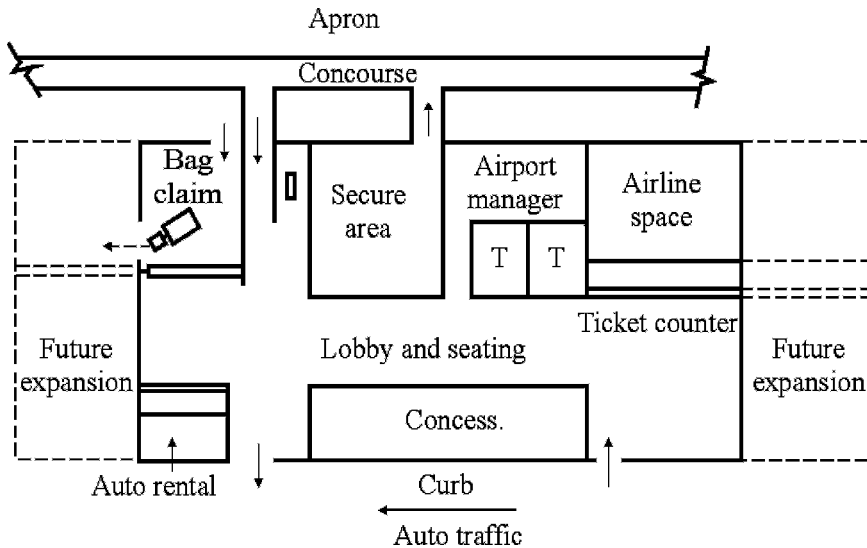

Odoni, 2003; Horonjeff and McKelvey, 1994; IATA, 2004). This chapter extends, rather than repeating, the literature by considering specifically the operational implications on design.

Figure 12-1 *Example of a functional terminal layout*

(Source: FAA Advisory Circular, *Planning and Design of Airport Terminal Facilities at Nonhub Locations*)

The main function of a terminal is to provide a convenient facility for the mode transfer from ground to air transport, and vice-versa. It is also the national frontier for international passengers, so needing to provide all the necessary facilities for this as well as those for the processing required by the airlines. The demarcation between the airside and the landside is usually within the terminal, marked by a security screen, the airside of which is subject to strict control of access prior to the boarding process. In most cases, only passengers are allowed airside, though in the US, where the airlines tend to operate their own terminals, those saying 'goodbye' (wavers) are also normally allowed to go right up to the aircraft gate. The landside is usually open access from where the passengers are dropped off their ground transport, through ticketing and check-in and up to the airside barrier.

On an airport with a great number of transit and transfer passengers the airside transit part of the terminal has to be dimensioned sufficiently and must be equipped with the systems for

transportation of the passengers so that it allows them to circulate rapidly and thus ensure short declared times between the connecting flights. The departure and arrival concourses can in this case be smaller. On the airport with mainly origin/destination traffic an increased attention has to be paid to the design of the departure concourse of the terminal.

Passengers and those accompanying them have many tasks to perform within the terminal, the more so with the trend to self-help rather than the use of porters and escorts. They have to find their way through a series of processes, often encumbered by coats, bags, dependants and disabilities. They also have to assist in being processed through check-in, security screening, passport control, the boarding gate, customs, immigration and picking up ground transport, often in a language which is not their first choice. The ambience the passengers experience influences them in three major ways: the stress experienced in accomplishing their group or personal goals, the form and nature of their social contacts and their feelings of identity and self-worth. Passengers are most stressed at check-in, security and boarding.

Travellers, airlines and other users of the terminal have their own ideas about the comfort, convenience, costs and ambience that should accompany the movement of passengers and their bags between aircraft and ground transportation. There are inevitable compromises to be made between capital and operating cost, between cost and level of service and between form and function, all of which influence a designer's ability to satisfy all the needs of all users. Only when passengers feel safe, know where they are going and have enough time to spare do they pay much attention to the levels of comfort and the attractiveness of their surroundings. The time needed to pass from the kerb to the aircraft, and its variability, is affected by the efficiency of the processing and the speed of moving through the building, the latter in turn depending on the crowding and the ability to find the correct route. The processing and crowding depend on the staffing levels, the number of stations at each processing point and the amount of space provided for a given throughput.

Efficient processing and movement requires good anatomical and physiological ergonomics for the passenger. Some of the common problems are:

Manoeuvring heavy trolleys:

- to check-in
- along extended 'crocodile' (or snake) check-in queues
- through customs to ground transport
- changing levels (except at Frankfurt and Kansai where the trolleys can be taken on escalators).

Check-in:

- height of the counter
- trolleys moving as passengers try to lift off their heavy bags
- impossibility of keeping weight of bags close to passenger's body when placing bag on scales
- hearing the operator's questions
- service 'justice'– in terms of being processed in order of arrival, which is ensured by 'crocodile' (or snake) queues at the expense of the appearance of a great queue length (Figure 12-2).



Figure 12-2 The 'crocodile' queues should guarantee service 'justice' but usually can result in long waiting times (Photo: A. Kazda)

Movement through the terminal:

- slippery floors
- lack of assistance with coats and hand baggage – there is a trend to carry more bags on board but few airports provide trolleys in the airside of the terminal.

Despite these problems, the primary factors controlling passenger acceptance are the space provided, the minimum and maximum times required and the wayfinding ability.

The design of an airport terminal is affected by the composition of the mix of passengers and by their requirements. For example, in airports with a great proportion of charter flights, the concourse in front of the check-in counters must be sufficiently deep and must offer enough space to cope with the inevitable long queues of passengers arriving in large batches and being processed through a small number of check-in desks. They are normally either migrant workers or package holidaymakers, frequently with over-sized baggage, and often impede free movement in the departure concourse. Airports with a high proportion of business travellers must offer them fast check-in and the shortest possible distance to the planes. It is therefore important, before starting the design of the terminal building, to know the type of airport operation, type of passengers, their composition and their requirements.

However, the type of operation and the passengers' characteristics in the airport can change, either gradually or suddenly. Because of these changes, caused not only by economic but also by political factors, the terminal buildings must be designed very flexibly. This is particularly true for utilities: gas, electricity, water, telecommunications, and security management systems. See Figure 12-1. Examples of such changes might be the introduction of a special channel for checking in passengers of the European Union at the airports of the new member states of the European Union or changing concessions layout following the abolition of duty-free sales. Therefore the terminal buildings must provide fast, simple and cheap reconstruction. Changes of the layout of the building must be executed so as not to disturb substantially the check-in or bag claim processes, given the difficulties in changing conveyor routings. In the past, designs have often been too inflexible. The new Denver airport had to make many expensive changes, even prior to opening, due to the late choice of a complex automated baggage system, then the system not functioning and one of its two major carriers reducing its services to a minimum. Instead of masonry partitions in the terminal building it is more suitable to use light assembled or wood partitions or even 'moving walls', which can be moved within one night or a few hours. It is then necessary to make the service installations in the floor or, even better, in the ceiling of the terminal building. The terminal must be capable of further and simple extension as the number of passengers increase without the necessity of further significant modification of its critical elements such as foundations, staircases and services. The terminal building layout must in particular provide for:

- ➔ terminal – air-side connection
- ➔ terminal connection to the land-side surface transport system
- ➔ as short as possible walking distances of arriving and departing passengers
- ➔ information for the passengers during the whole series of processes

- convenient connection for transfer and transit of passengers
- baggage-handling system for local and transfer bags
- airside/landside security screen
- government controls
- appropriate sizing of all areas
- required mix and quantity of aeronautical and non-aeronautical services
- space for offices and all support services.

However, well a terminal is designed, it will only achieve its purpose if it is operated efficiently. It is all too easy for standards that could be met to fall short because of poor management. An essential tool for maintaining quality is to make Service Level Agreements (SLA) between the airlines, the government services and the airport. The SLAs should be monitored by surveys, questionnaires and an easy to use complaints system. The agreements should cover, among other things:

- fixed ground power serviceability
- aircraft parking stand availability
- remote coaching performance
- people mover serviceability
- bag systems serviceability
- queuing standards
- security service standards
- ease of wayfinding
- availability of seats
- cleanliness.

12.2 AIRPORT TERMINAL LAYOUT

The terminal building is a connecting link between the air-side the land-side. It is a connection between 'the sky and the earth'. First and foremost, it must provide basic aeronautical services; that is activities directly connected to provision of the passenger check-in process. The building must provide a fast and the shortest possible transition of the passengers from the surface transport through the outbound processes to the aircraft on departure and in the opposite direction on arrival.

The arriving and departing passengers must be physically separated, not only for fast and fluent movement of the passenger flows but also in order to ensure security (see Chapter 13). The flows of passengers can be separated by fixed or moveable obstacles on a single level (horizontally) or on several levels (vertically).

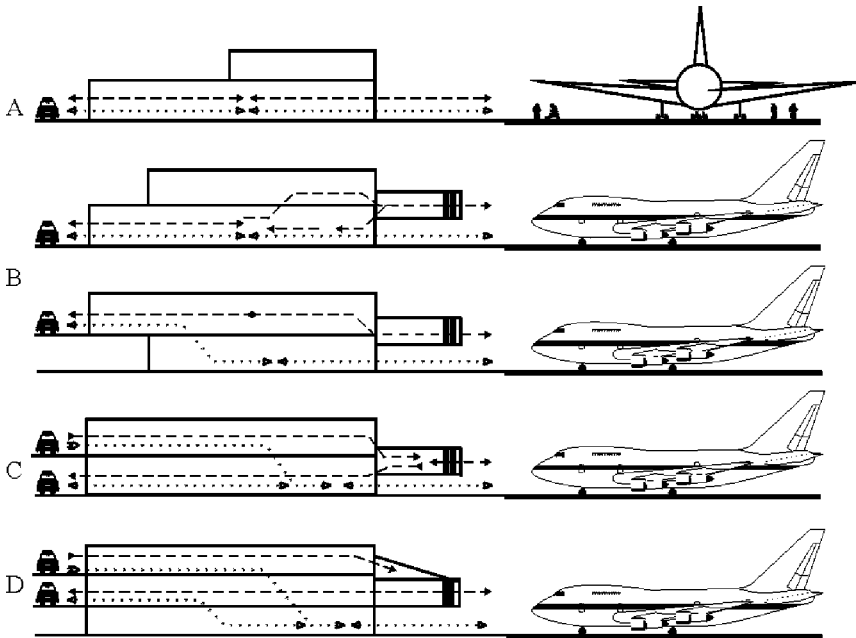

*Figure 12-3 Airport terminal layout
a/ single level concept b/ one and half level concept
c/ double level concept d/ three level concept*

For small airports, a single level concept is the most suitable (Figure 12-3a). In this concept the departing and arriving passengers and their baggage are separated horizontally, usually on the same level as the apron. The arriving passengers on domestic flights often do not even pass through the terminal building and the baggage is directly handed to them from the baggage cart under a shelter or even near the aircraft. In this single level concept passenger loading bridges are not used, though the concept of a telescopic cover to protect passengers from the weather was introduced at Oakland, California by 1930 and installed at the original beehive terminal at Gatwick in 1936 [12-B].

If terminal buildings at larger airports were designed on a single level, the terminal would require a large area of land. It then becomes more convenient to separate the passengers vertically. The simplest type of vertical separation is a concept of one and a half levels in several variants according to local conditions (Figure 12-3b). Normally the departure and arrival landside

concourses are on the same level side-by-side. The division of flows of departing and arriving passengers and baggage can be done at any point after the check-in process or alternatively immediately after the entrance into the terminal building. Both levels meet again on the apron if the passengers are to walk or be bussed to the aircraft. However, if passenger loading bridges are regarded as necessary for passenger safety or as economically viable, the flows meet again at the entrance to the airbridge. In either case, departing passengers are held behind a barrier until all arriving passengers have been cleared into the terminal.

The double level concept provides separation of the passenger flows even on the landside by vertical stacking of the road access system, though with the capability to move between the levels inside the building (Figure 12-3c). The double level concept is usually used for terminals with traffic volumes of above 5 million passengers a year.

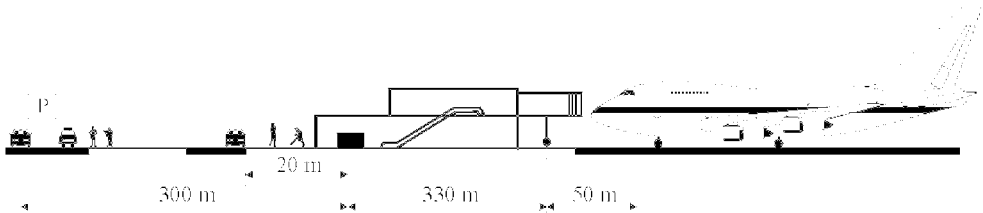

Figure 12-4 *Maximum IATA recommended walking distances*

The FAA suggests that it may be worth considering a two level terminal when the traffic exceeds one mppa, a two level kerb when it exceeds two mppa, and multiple terminals by the time traffic has reached six mppa, but, in most parts of the world, traffic would have to be considerably higher to justify these solutions.

In addition to the flows of arriving and departing passengers the three level concept also separates baggage vertically (Figure 12-3d). It is particularly advantageous to use this concept at airports where the baggage transport system and also other systems for technical handling have been designed below the level of the apron.

The flow of passengers through the departing process must be direct, logical, limiting the changes on the vertical levels and as short as possible. Maximum walking distances for the passengers are recommended by the International Air Transport Association (IATA) as shown in Figure 12-4 and described below:

- ➔ from the departure kerbside in front of the terminal building to the check-in counter 20 m
- ➔ from the farthest car park to the check-in counter 300 m
- ➔ from the check-in counter to the farthest - gate 330 m

→ from the gate to the plane

50 m

The walking distances are similarly specified also in the case of passenger transfer between aircraft. If the distances are longer than specified, it is necessary to provide some kind of mechanical assistance for the passenger (see Section 12.7). ICAO suggests that the time from disembarking the aircraft to exiting the terminal should not exceed 45 minutes for international passengers.

12.3 AIRPORT TERMINAL CONCEPTS

The terminals at small airports have mostly been designed as centralised buildings, that is, where the processing of the passengers is done in one location rather than being distributed through several points in the terminal. The concept of the centralised terminal in combination with piers, fingers or satellites (refer to Chapter 7 for a discussion of these various terminal layout options) is also used at large airports. It provides easy orientation for the passengers through check-in and security, optimum utilisation of space and concentration of services in the terminal building. However, as the number of stands increases, the distance to the outlying stands exceeds the recommended walking distances and therefore it is necessary to provide transportation for the passengers from the central processing building to the gates, together with an effective information system. A central terminal building with a system of several parallel satellite piers interconnected by a transportation system makes an almost ideal solution for large airports if the space is available midfield, i.e. between parallel runways. It has a large capacity of both stands and peak hour passengers. It enables transfer of passengers to and from common travel areas without using the central building, which is then not required to handle these passengers. Therefore this design is convenient for the hub and spoke type of operation. This design was first used at Atlanta, and has now been adopted at Oslo – Gardermoen, London Stansted, Denver, Berlin Brandenburg and London - Heathrow Terminal 5, among others. It seems that it is possible to use central processing terminals up to about 30 mppa and 50 or so gates, whether they have piers and moving walkways or have satellites and people movers.

In the past, large airports preferred the concept of several decentralised buildings, with the traffic segregated between terminals by airline, by domestic/international or by some other categorisation of passengers. This is particularly typical for airports in the United States, where the construction of terminals is often financed by airlines. It is still preferred by, for example, Air France at Paris Charles de Gaulle Terminals 2A, 2B, 2C, 2D. It can offer very late check-in, there is no need for passenger moving or complex bag sort technology inside the terminal, the Flight Information Display System (FIDS) can be simple, there is plenty of kerb, and expansion simply means building another unit. However, when transfer between buildings is unavoidable, it is often necessary to

provide transportation of the passengers by some form of people-mover between the terminal buildings in order to minimise the connecting time (see Section 12.7).

Now that the Low Cost Carriers (LCC) are demanding dedicated low cost airport facilities, a new era of decentralised terminals is being launched. Singapore Changi airport has a 25 000m² single storey building at a cost of EUR 12.5 million with basic facilities and no airbridges to handle 2.7 mppa, i.e. 9 m² per 1000 ppa. The airlines will pay only 50% of the rent in the other terminals. Jet Blue is building a 59000 m² terminal on two levels at New York's Kennedy airport with 26 gates and a short term capacity of 10 mppa, i.e. 5.9 m²/1000 ppa. Kuala Lumpur opened a single storey low cost terminal in 2006 for Air Asia, costing \$US 30 million for 10 mppa with 72 desks in 35,290 m², i.e. 3.5 m²/1000 ppa (Airline Business, October 2006). Lyon St. Exupery airport has refurbished an old charter terminal, and the passenger handling charge is only 16% of the normal charge. Some of these terminals are being built at only a quarter of the price of a traditional terminal. The LCCs have very few passengers transferring onto the legacy carriers, and do not even encourage hubbing on their own network, so there is little need for people-movers in their case. If the need arose, bussing would be the appropriate option.

Another concept is the linear type of terminal building. This is particularly suitable for 'point to point' operations and for a simple passenger handling process, e.g. domestic operation. The linear terminal building is formed by multiple individual modules independent of each other. It needs a near-perfect information system for access so that departing passengers obtain precise instructions as to the terminal location they require. The main advantages of the concept of a linear building is minimum walking distance from the departure kerb-side in front of the terminal building into the aeroplane, and simple baggage handling. The main disadvantage is relatively high staffing levels, as it is necessary to have a security check in each module, though some airports and governments require a security check at each gate even in centralised terminals. Also, it is difficult to provide shopping and catering facilities, which are becoming an increasingly significant source of airport revenues, and it requires dedicated sets of gates for specific flights. In its curvilinear form (e.g. Dallas Fort Worth) it is somewhat incompatible with moving walkways.

This concept hardly still exists in its classical form, except in very small scale terminals, though it can be seen in operation on the landside at Dallas-Fort-Worth. It is best used for domestic point-to-point operations.

12.4 TERMINAL DESIGN

12.4.1 Design Methods

The standard approach to calculating appropriate space is to choose a representative busy hour, accepting that, for the few hours per year for which there will be more traffic, there will be unacceptable levels of crowding. The crowding will be absent for most of the time, perhaps 15 years, when the traffic is growing towards the design busy hour, though it has to be said that most terminals then go on to operate for years after the design conditions are reached before any expansion is built.

The US Federal Aviation Administration (FAA) uses a concept of the peak hour of the average day of the peak month to derive the representative peak hour. An approximate rule of thumb is for the average day in the peak month to be 1.05 times the annual average day, and for the peak month to be 10% of the annual traffic. The typical peak hour passengers (TPHP) may be as much as 20% of the day's traffic for small airports, falling through 11% for 2 mppa to 8.6% at very large airports. The FAA also uses a concept of Equivalent Gates (EQA) for the analysis of space requirements based on a nominal 100 seats per aircraft, so that a B747 gate is rated as 4.5, a B747SP as 2.7 and an F28 as 0.5. The air transport movements are not usually as peaky as the passenger flows, i.e. the load factors are higher in the peaks.

IATA's concept of a busy hour is derived by taking the 2nd busiest day of the average week of the peak month and selecting its busiest hour. Other peak hour concepts are the Standard Busy Rate (SBR) which refers to the 30th busiest hour in the year, the 20th busiest hour (at Amsterdam), the 40th busiest hour (Aéroport de Paris) and the 5 percentile hour in the year (BAA). The SBR can often be approximated by dividing the mppa by 3000.

A further option for identifying a design hour, appropriate for airports where there is a stable daily pattern through the week due to the operations being dominated by scheduled carriers or for airports with only a few commercial movements per day, is to construct a notional schedule and select the busiest hour. The problem with this approach is that the world is becoming increasingly uncertain, and it is nearly impossible to anticipate airline behaviour sufficiently far ahead.

The FAA (1988) and IATA (2004) have developed procedures, or models, for calculating required areas for each activity within the terminal, based in the busy hour flow and acceptable standards for queuing time and crowding. Note that the FAA often uses 'enplanements' rather than 'passengers', the latter implying the total number of passengers handled in a given time, whether arriving, departing or transferring. It is necessary to be specific about the flow rate for whichever facility or activity is being designed. The FAA models are appropriate for the US system and deal

comprehensively with all activities in the terminal. The IATA models are aimed at terminals worldwide, but they are not so comprehensive and tend to be difficult to apply, leading to errors if not used with care. Both models tend to assume that the traffic is constant in the busy hour. There are also models for small airports developed by the FAA (1980) and by Transport Canada (1992). The latter, called STEP, is appropriate for airports up to 3 mppa.

Guidelines are available for the amount of space per passenger in the busy hour which will give a required level of service (LOS) (Table 12-1). The IATA LOS standards for space requirements range from 2.7 m² to 1.0 m² per occupant for LOS A to F respectively for long term waiting space, reducing to 1.4 m² to 0.6 m² for gate holding rooms. The A level of LOS refers to free flow and an excellent level of comfort, C to a good level of service with stable flow, acceptable delays and a good level of comfort; D is adequate LOS, with acceptable delays for short periods, but the flow is unstable; F is unacceptable for delays and comfort, delays are unacceptable, there is cross-flow and the system breaks down. The crowding should not fall below level D for the TPHP, and most new terminals aim for C in the busy hour. Guidelines also exist, which are different from one airport to another, for acceptable queuing times and movement rates.

Table 12-1 Level of service – space to be provided for passengers in different functions

Activity	Situation	Level of service standard (LOS)					
		[m ² /PAX]					
		A	B	C	D	E	F
Waiting and circulating	Moving about freely	2.7	2.3	1.9	1.5	1.0	Less
Bag claim area (outside claim devices)	Moving with bags	2.0	1.8	1.6	1.4	1.2	Less
Check-in queues	Queued, with bags	1.8	1.6	1.4	1.2	1.0	Less
Hold room; government inspection area	Queued, without bags	1.4	1.2	1.0	0.8	0.6	Less

Source: de Neufville, R and Odoni, A: Airport systems – planning, design and management, McGraw Hill, New York, 2003

For the terminal building as a whole, the FAA gives a rule of thumb of 14 m² per one way peak hour passenger for the gross floor area of domestic terminals. IATA suggests 25 m² to 30 m² for domestic and charter terminals. Within the total space, 5% will be unusable, rather more than 50% will be rentable and rather less than 50% non-rentable. In the US domestic terminals, some 38% will be used by the airlines, 17% by other concessions, 30% by public circulation areas and 15% by airport administration.

Care has to be taken in the application of these analytical models. They are based on handbook formulas insensitive to the realities of each situation, and the formulas are easy to misunderstand and thus frequently misapplied e.g. the common design hour LOS standards should apply to simultaneous occupants (except the FAA guidelines per TPHP), but are often used per design hour passenger even if their dwell time is much less than an hour. Also, the TPHP differ in different parts of the terminal. They should be improved by a realistic appreciation of the dynamics and behaviour of sequences of queues, the psychology of crowds in such situations, and the ways airport users truly allocate the time they spend in passenger terminals – their slack time is often much greater than their processing time. People do not spread out evenly like gasses, but tend to congregate in specific places, e.g. the mouth of the baggage chute in the baggage reclaim hall. LOS standards should increase with exposure time. The requirement is also strongly influenced by whether the activity is to be joint use or dedicated to an airline, a route or a type of operation. Territoriality in public spaces leads to a wasteful use of public facilities.

‘Intensity of use’ and ‘service time’ are less value-laden terms than ‘crowding’ and ‘time delay’, and may therefore be more appropriate as general measures of performance. Because passengers are often accompanied by visitors, and because the occupancy may turn over several times in the peak hour, total numbers of people accommodated simultaneously may be a more appropriate measure than passengers per peak period. Current measures of performance based in the space requirements for a standard ‘busy period’ are poorly suited to terminals serving intensive hub-and-spoke flight schedules, aircraft fleets with large fractions of high capacity wide-bodied and commuter aircraft, and growing numbers of price-conscious passengers. In fact, there is a large variety in passenger perceptions of adequate space. The length to which an individual will go in accepting cheerfully what most would consider to be extreme inconvenience is remarkable, so long as it is his/her own choice. This is reflected in the recent calls by the LCCs for the minimum of facilities in new terminals in order to keep charges down.

The accuracy of the model results depends also on the availability and suitability of the input data. If there is insufficient data there can be only approximate solutions; for example, in the design of the kerb length in front of the terminal building it is necessary to know the split of the passengers arriving to the airport by car, taxi or by bus, the average number of the passengers in each of the means of transport, average time of stay for each vehicle and the length of waiting space necessary for each of the means of transport. Often, the length of the kerb has to be designed using the default values for all kinds of vehicles. For small airports, under 0.5 mppa, it is advisable to compare ‘rules of thumb’ values with expert judgement.

For airports with passenger volumes from 0.5 to 5 mppa, the use of fixed ratio models is problematic. The volumes of the passengers are already too big to assess the results obtained from

static modelling by expert judgement, but too small for the system of the airport to be relatively stable. Therefore it is more appropriate to use simulation models for the dynamic modelling of such airports.

Simulation models allow individual parts of the building to be considered operating under different conditions. Thus, for check-in counters, it is possible to set different lengths of the queues for the different categories of the passengers: 3 passengers in the queue for the passengers of the first class, 5 passengers in the queue for the business class and a waiting time less than 15 minutes for 90 % of all passengers, etc. to determine the number of counters required, and also to carry out sensitivity analysis around the central specifications. The models of each individual part of the building can be combined to see how the parts influence each other, taking account of the way passengers spend their spare time. For example, it is possible to investigate the effect of immigration processing on the crowding in the bag reclaim hall, depending on the relative productivity of the two activities, thus avoiding the need to provide duplicated waiting space. Again, the models are only as good as the data that is fed into them. The collection of the behavioural data is very time-consuming and costly. It is necessary to know the behaviour of each type of passenger (e.g. domestic/international/transfer, business/leisure, group size, disability, with/ without bags, mode of arrival) and visitor for each decision point throughout the terminal.

There are several simulation models of terminals available such as ARCportALT (Aviation Research Corporation), PBFM (Passenger and Bag Flow Model) and CAST (These models tend to have to be tailored to each specific terminal floor plan, being constructed from CAD drawings. More generic models like ARENA and WITNESS do not need to know the shape and size of the facilities in advance of the modelling. Given the data, these models can generate facility size requirements, assess queue lengths, the degree and duration of crowding, the processing times, waiting times and dwell times throughout the day for each type of passenger. Some of them also assign gates and estimate the number of passengers and bags failing to catch flights. Once the model is calibrated and running, it is easy to carry out sensitivity analysis and ‘what if’ analysis to compare multiple options.

A major strength of these simulation models is their ability to present real time graphic demonstrations of the flow using three-dimensional animation, and it is possible to watch queues and crowds build and decay relative to one another throughout the terminal. They also present the results of queue length, level of service, etc. in easily digestible graphics. In fact, the user has to continually remember the quality of input data in order to keep a sense of proportion as to the validity and accuracy of the results. Perhaps the most valuable aspect of using terminal simulations, is that it asks difficult questions of the operations and management staff, and gives them a better understanding of the way their terminal works. It can act as a focus for discussions

between all parties interested in the design and functioning of the terminal.

12.4.2 Component Design

The landside kerb is used by cars, taxis, courtesy busses and public busses for drop off and pick up. The various vehicles are often segregated to separate kerbs, with the consequent need for most people to cross lanes of traffic. They are also segregated between arrivals and departures, either spatially in single level terminals or vertically in two level buildings. A typical total kerb length is 1 m per 10 TPHP, but this depends very much on the mix of traffic and the discipline at the kerb. It is often the case that vehicles stay longer than permitted, and strong policing is required. There is also a problem with security when vehicles are left empty while meeting or waving. Some airports have now banned the use of close-in kerbs, and force people to use a park and ride system.

The ticketing lobby requires 4 m of queuing space, a counter and space behind the counter for staff and facilities; perhaps some 2,500 m² for 50 EQA. The lobby is usually on the back all of the check-in concourse.

The check-in concourse needs, in addition to the counters, some basic facilities like flight counter information, telephones, toilets, and a small café for people who wish to linger with those who are seeing them off, but the general aim is to move passengers through the security screen quickly after check-in so as to avoid delays and crowding. It is becoming increasingly common to provide self-service kiosks, whether dedicated to an airline or Common User Self Service (CUSS) kiosks (www.iata.org/CUSS), together with fast bag drop facilities for the kiosk users with bags. This is more common among the legacy carriers than with the LCCs and the charter carriers, whose reservation systems are not so compatible. An essential element of the terminal design is the communication system and their ducting to drive the reservation systems. The area depends on the TPHP, type of traffic, counter configuration, percent of e-ticket sales, level of service, average processing time and ratio of passengers to accompanying people. It is preferable to keep the latter away from the counters and their queues. This is best done by having a crocodile queue with airline personnel checking the right to board at the entry to the queue. The concourse should be at least 20 m deep to allow for queues at right angles to the counters, and for circulation space behind the queues. LOS level requires 2.3 m²/pax with a trolley while they move around the concourse. The normal speed can be presumed to be 0.9 m/sec.

Check-in counters may be provided at train stations, car parks, downtown or at gate lounges, but it is most common to situate them immediately after the entry to the terminal. They may be arranged linearly facing the passengers when they enter the concourse (Heathrow Terminal 4, Manchester), end-on to the flow (Figure 12-5) (London Stansted, Hong Kong) or in islands (Heathrow Terminal

1, Dublin). The linear facing type may allow passengers to move on through the line of desks after processing, or require them to move across the queues to the departure gates. This latter arrangement can lead to confusion unless there is a lot of room behind the queues, but it is by far the most common layout.

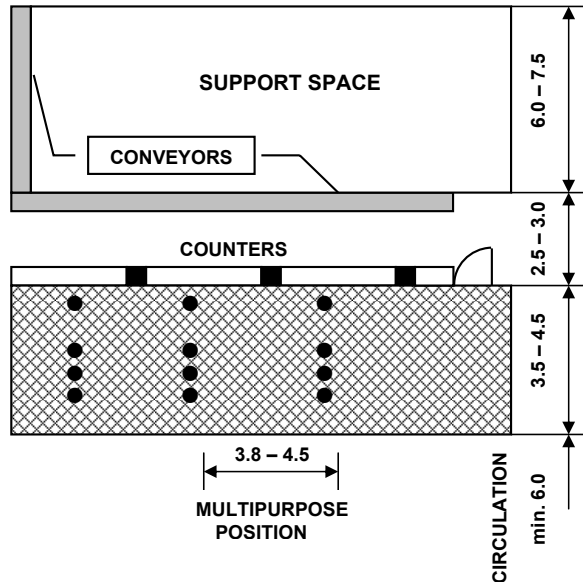

Figure 12-5 *Linear counter (all dimensions in meters)*

(Source: FAA AC 150/5360-13 Planning and design guidelines for airport terminal facilities)

The conveyors run along behind the counter staff, and are fed by a short feeder belt running back from each pair of counters. The flow-through types take more space and cost more to build and maintain (Figure 12-6). The island types have the counters arranged in a U shape around belts running in the direction of the passenger flow (Figure 12-7). They offer some element of flow-through and make efficient use of the conveyor belts because they can be fed from both sides. IATA has a preference for the island layout, with between 10 and 20 counters per side and with 20 to 30 m separation between islands. The average processing time is 2 minutes, depending on number of bags, size of group and procedures required by the authorities. The FAA suggests that, for 50 EQA, 86 m of counter frontage is needed for a hubbing terminal and 148 m for an O-D terminal. Each pair of counters takes approximately 3.5 m, so a total of 84 counters is needed. The area needed is 571 m² and 981 m² for hubbing or O-D respectively. It has to be remembered that these guidelines are for domestic operations in the USA. IATA rule of thumb is that for 2500 departing passengers per hour (i.e. rather less than 50 EQA) and a 10 minute maximum queuing time, 70 economy desks and 14 business class desks are required. However, IATA also suggests

that 5 economy, 2 business and 1 first class desk is needed for a B747-400, which seems to be rather less than the previous rule of thumb. Another rule of thumb is that 9 counters are needed per 1 mppa. A B747-400 may present 80 passengers in the peak 15 minutes about 90 minutes before boarding. An A380 will therefore present perhaps 120 passengers in the same period, requiring 50% more desks if queues are to be kept under control. LOS level requires 1.2 m² per queuing passenger with few bags, rising to 2.0 m² for one with two or more bags. The acceptable queue time in economy is deemed to be 12 minutes, and 3 minutes in business class.

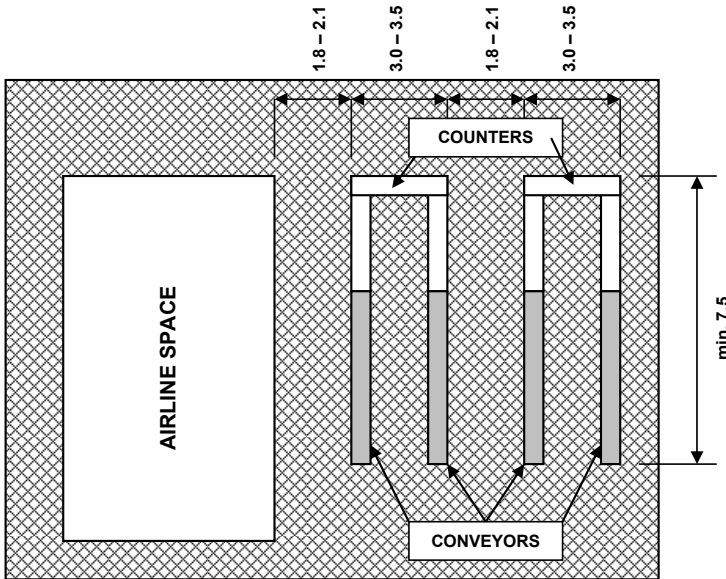

Figure 12-6 Flow-Through counter (all dimensions in meters)

(Source: FAA AC 150/5360-13 Planning and design guidelines for airport terminal facilities)

The out-going baggage handling system is usually installed under the floor of the departure level at large airports. It consists of:

- ➔ belts, or trains with tilting trays or destination-coded vehicles
- ➔ sorting devices that read the codes on the bags and either push the bags off the belts or tilt the trays to assign the bags to the flight make-up area
- ➔ a screening system
- ➔ a feed for transfer bags.

The system needs to be able to handle a large number of bags; between 0.8 and 2.2 bags per

passenger, or between 1600 and 2200 bags per hour for 4 EQA and between 16000 and 26000 per hour for 50 EQA. IATA suggests that it should take no longer than 9 minutes for a bag to get from check-in to the furthest make-up area. Transfers from domestic to international should take less than 25 minutes, from international to international no more than 35 minutes. This may require fast track routes for rapid flight connections; it may be necessary to transfer directly on the apron.

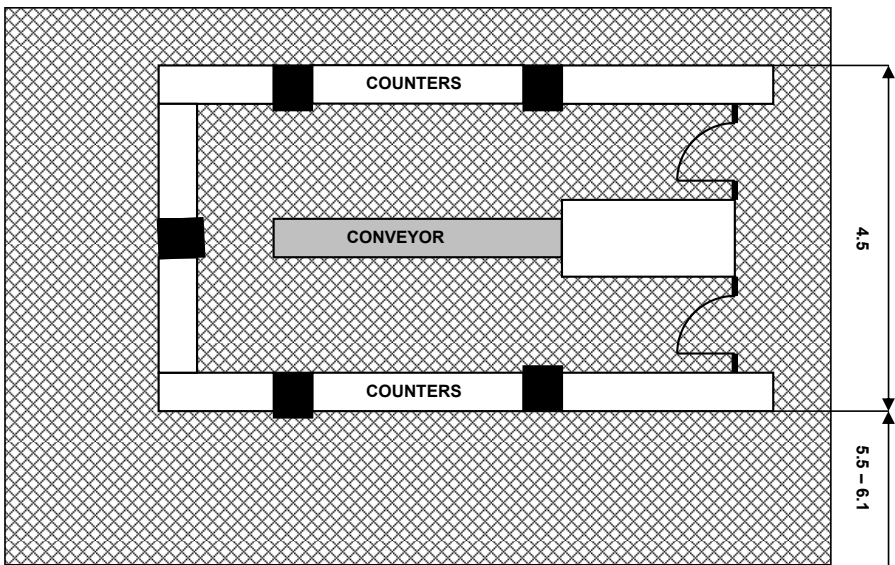

Figure 12-7 Island counter (all dimensions in meters)

(Source: FAA AC 150/5360-13 *Planning and design guidelines for airport terminal facilities*)

The conveyor belts normally operate at between 0.4 and 0.8 m/sec, giving 26 to 50 bags per minute, but can achieve 1.5 m/sec if acceleration and deceleration belts are employed. Slopes should not exceed 22 degrees. Chutes may be used for down-slopes, but there is a greater tendency to damage the bags. If there are many flights to be served, it is necessary to install belts that recirculate past the fixed make-up stations for each flight, where the carts for each flight are usually positioned parallel to the belt for ease of loading. Those belts with inclined beds can carry a double layer of bags. Semi-automated sorting can be installed, where a pneumatic arm pushes the bag onto the appropriate slide, actuated by a signal from the operator who reads the baggage tag. The system can sort about 30 bags per minute.

Tilt-tray systems have been used extensively for high volume terminals. They are complemented by conveyors onto which the trays discharge, so that the bags can accumulate before being loaded on to the carts. Despite early teething problems, destination-coded vehicles have been used recently instead of tilt-trays. These have an individual cart, or 'tub', for each bag, running on a

static rail system and with the coding on the cart. They can be operated up to speeds of 12 m/sec and cope with slopes of 33 degrees. The carts can be moved by electric motors in the track which only power up when the cart approaches (e.g. TUB TRAX, working at 3000 carts per hour at Leipzig), or by linear motors in the carts (e.g. BAG TRAX, working at 4500 carts per hour at Amsterdam). The ALSTEC carts at Heathrow travel some 150,000 km per year. It is simple to pull a cart out of service without disrupting the service, whereas, if a belt fails in a more traditional system, the whole system is stopped (Airports International, July 2006). Whatever system is used, a back-up system with 75% of the main system should be available. Experiments are currently being done on Radio Frequency Identification Technology (RFID) to track bags more efficiently. It should soon be possible to arrange home pickup of bags with RFID tags.



Figure 12-8 For small airports simple manual sorting system is sufficient – Brno Airport
(Photo: A. Kazda)

The size of the sorting and make-up hall depends on the bags per passenger and the type of technology employed. The beds are usually 42 m long. For manual sorting from belts, 170 m² is needed for 4 EQA and 2100 m² for 50 EQA, with 1.3 bags per passenger (Figure 12-8). The area should be increased by 100% if destination-coded vehicles are used and by 150 to 200% with tilt-tray sorting. Aisles around sorting devices and carts should be 1 m wide, and traffic lanes for cart

trains should be 3 m wide with 6.5 m turning radius. Great care should be taken in locating columns and in arranging for adequate ventilation.

Outbound passport control can achieve an average processing time of 20 seconds. As an example, if there are 7 desks and if the maximum desirable queuing time is 5 minutes, the queue could be 105 people long. The spacing in the queue is 0.8 – 0.9 m, 1 m² per passenger giving LOS level C. Space needs to be available in the check-in hall for this size of queue to develop. Clearly, if people present themselves at greater than the flow rate of 21 per minute for a sufficiently long time, e. g. if, say, 350 people leave the check-in counters in a 10 minute period, the queue could exceed the maximum desirable length. It should not be necessary to wait more than 5 minutes. It is often difficult to persuade government offices that more desks should be opened in such a case, so it is necessary to try to manage check-in so as to deliver a smoother flow, or provide more queuing space and accept a lower level of service. The process should be speeded up with the introduction of Advanced Passenger Processing (APP), using biometrics and machine-readable passports.

Security screening of passengers requires a walk-through detection device, an X-ray machine for accompanied baggage and space for manual searches and recovery of the X-rayed items. The FAA suggests that each security station requires an area of 10 m² to 15 m², and that it can handle 500 to 600 passengers per hour (pax/hr). However, the flow rate at Heathrow, until more severe requirements were put in place in late 2006, was 270 pax/hr per facility. The rate fell to 210, but improved management of the process should bring the productivity back to 270 pax/hr or 13.3 seconds per person. It is difficult to see how the FAA productivity estimates can be achieved with today's security regime, so the security queues should follow roughly the same calculations as for passport control. Meanwhile, the queues have sometimes been backing up to landside.

Corridors have an effective width some 1 m less than the actual width, because of a reluctance to use the space in the 'boundary layer' near the walls. The effective width is also reduced by facilities such as telephones, and displays which encourage people to congregate in front of them. If the average walking speed is 74 m/min, a corridor with an effective width of 6 m will allow a flow of 300 to 600 people per minute, depending on how wide the people are and how closely they follow one another.

The departure lounge should have, as a minimum, space for the essential activities of waiting for flights to be called and then queuing to board the flight, and the facilities required for processing the passengers. There should also be telephones, toilets and some minimum catering for those whose flights are delayed after they have passed through security. At today's load factors of around 75%, this requires approximately 1 m² per seat of the aircraft being boarded. Seats should be provided for some 50% of the expected number of passengers unless it is likely that they will be held for a long time, this being dependent to some extent on the boarding policy of individual

airlines (Figure 12-9). The space required per seat is 1.5 m^2 to 2.0 m^2 , and for circulating is 1.5 m^2 to 1.8 m^2 /pax for LOS level C.

Retail (or concessions) were originally concentrated in the duty-free shop, initiated first by Aer Rianta at Shannon airport in the 1950s. This is changing within Europe with the international traffic between some 30 countries now being considered 'domestic' from the point of view of duty paid. This has caused a serious loss of revenue for the airports. Another near essential is the stationers or drug store. The main stationer at London Gatwick employs 260 people in 13 outlets both landside and airside, with annual sales of 2.2 million books and 4.5 million newspapers. All the airside goods and employees have to be screened. It is necessary to have secure truck bays for delivery and waste removal, and to have back-of-house paths for food, waste, and stock so that such movements can be kept away from the passengers.



Figure 12-9 *There must be guaranteed minimum LOS for passengers who can wait for their flights for long hours in the airport lounges (Photo: A. Kazda)*

Retail in all its forms is a growing activity within airports as they search for new ways of increasing revenue. At least some of this trend is to the passenger's advantage. Passengers generally find it useful to have shopping and catering facilities in a mix appropriate for the type and the volume of traffic. Some feel that too much retail gets in the way of the passenger flow towards the gates and causes delays. However, airports which put the retail facilities out of the main flow, like

Washington National or Rio de Janeiro Galeao, lose revenue because the passengers cannot be bothered to search out the opportunities: the impulse buyer cannot be easily captured. Also, if there are few outlets, the passenger does not get the price control that comes from competition.

The passenger will tend to spend more when relaxed, so they need a comfortable base from which to visit the shops after having gone through the stressful check-in and security processes. Shopping at an airport is not like shopping in the high street. There is only a finite dwell time, the shopper cannot come back, and it is not the primary reason for being there. The spend will tend to be greater if the merchandise is visible, well lit and appealing, and if the shop is clean and neat. The solution developed by the BAA at, for example, Heathrow Terminal 4, is to combine the areas for the gate processing activities, retail and catering. The departure lounge is one very wide concourse with shared space for a wide range of highly visible shops. Revenues are high, the passengers have more to interest them and the flow is not impeded. It may be difficult to retain this design now that the new security regime requires more stringent checks at the boarding gate, and it may be necessary to revert to individual gate lounges for each flight. The split of floorspace should be about 60% shops and 40% catering. The total concession space in a terminal will typically be between 700 m² and 1000 m² per mppa.

Catering is predominantly airside. The FAA sizing methods suggest around 350 m² is required per mppa, but it could be considerably more or less, depending on the type of traffic and thus on the degree of use. Some 20% to 40% of the seating for catering may be count towards the total of required airside seats.

Gate rooms, where they are required or preferred, should have seating for 80% of the aircraft capacity at 1.7 m² per seat, and standing room for the remaining possible 20% at 1.2 m² /pax. Then LOS level C is achieved with a 65% load factor; a 95% load factor results in LOS level E. There must also be room for the airline counter and for a queue to form for checking the boarding pass and bag reconciliation prior to boarding. There is a conflict between the airline's desire to process passengers early into the gate rooms, and the passengers' aversion to being kept corralled for what may be an indefinite period with few if any facilities. Toilets should be provided if there is security control on entry. If there is a change of level from the gate room to the airbridge, escalators should not be used because the queue from the bridge could back up onto the escalator. The IATA sizing methods suggest that, when gate rooms are built along the sides of piers for a Code F aircraft like the A380, the total pier width needs to be at least 26 m².

Executive lounges are an important part of an airline's service to its Commercially Important Passengers (CIP). Business people need to be able to continue to conduct their business in suitable surroundings while they wait for their flights. Airlines sometimes share lounges when their business and first class market is small. At least four times the normal space should be used for sizing, to

allow for the expected levels of comfort. The lounges should be near to the access to the gates. One operator of the A380 has asked for a direct connection between the CIP lounge and the upper deck of the aircraft.

Inbound government controls cover immigration and naturalisation services; customs; public health; and livestock and plant health. Some countries install pre-clearance facilities at the point of flight origin, in which case provision needs to be made for those facilities at the origin airport rather than on entry. The areas downstream of inspection for passengers and for their baggage should be sterile. At the entry airport, strict segregation is required of international passengers from domestic passengers and the public by means of a physical barrier and with strict controls on entry and exit. There should be no public phones. The areas should be well lit and without glare. Baggage from international flights should also be segregated. Transit passengers should have their own secure waiting room. The total space required for the support of all these activities is approximately 750 m² per 1000 peak hour international passengers. The processing time is longer than on departure, and may average 30 seconds, depending on the origin of the passengers. In completely smooth flow, the 1000 passengers per hour could be served comfortably by 9 desks. However, passengers usually arrive in large batches from international flights, typically 300 within 10 minutes, during which time only 50% would have been processed by the 9 desks by the end of the 10 minutes, and people at the end of the queue of 150 passengers would have to wait a further 10 minutes. The largest international terminals receive more than 5000 arrivals per hour, or perhaps 16 aircraft, so the flow into passport control is smoother and 40 desks might be sufficient. An acceptable time for waiting in the inbound passport queue is 7 minutes.

Customs require inspection tables, interview rooms, payment facilities, kennels, a bonded warehouse and space for administration and accommodation for staff.

A separate **reception lounge** is required at gateway airports, where visiting dignitaries may be entertained while the formal processes are completed on their behalf.

The baggage claim hall needs to be close to the airside road system for ease of transferring bags from the carts to the reclaim belt, and also close to the landside access points so as to avoid long walking distances with baggage. Airside it contains tugs/dollies/containers pending flight make-up, tug charging (if electric), staff restroom, early bag store. Landside it normally contains one or more bag reclaim units (carousels), though a simple roller bed fed from airside by gravity may be used. It is important to provide currency exchange and toilets in this area, as passengers wish to use the time while waiting for bags to make themselves comfortable after the flight and before being met. The reclaim units may be either flat bed or sloping bed devices, the latter being able to carry a double row of bags. They may circulate round from airside to landside on the same level, or a conveyor may provide a remote feed to an island carousel on a different level to the airside dock.

The length of claim frontage depends on the number of aircraft arriving in a peak 20 minute period. The arrival of 16 EQA in the 20 minutes might need 150 m of flat-bed frontage. It is unusual for beds to have more than a 50 m frontage, in which case 3 carousels would be necessary, but this might increase to 6 if the number of bags per passenger and the percentage of passengers terminating locally were both high. Equally, if most flights were short haul domestic, 2 carousels might be sufficient. If the 16 EQA were 4 widebody aircraft, it would be most convenient to have one sloping bed carousel for each of the aircraft. The reclaim hall area should be approximately 9 m² per metre of claim frontage, to include storage of bag trolleys, lost bag facilities and airline offices. LOS level C needs 1.7 m² /pax.



Figure 12-10 A waiting time for bags of 12 minutes is deemed to be acceptable
(Photo: A. Kazda)

There should be approximately 12 m between the claim units. The airside input area should be approximately 3 m² per metre of claim frontage for a U-shaped flat bed, rising to 6 m² per metre for a remote sloping bed carousel. A waiting time for bags of 12 minutes is deemed to be acceptable (Figure 12-10). The introduction of the A380 is causing airports to increase the size of their belt reclaim lengths from the existing 50 – 60 m to 75 – 90 m, usually by adopting W-shaped sloping beds, in preference to using two belts per flight. Airports should aim to have bags on the carousels

before passengers arrive from immigration controls.

Some airports already offer duty-free on arrival (e. g. BAA Heathrow, Rio Galleao). The new security measures may make this a more attractive addition to the pre-customs facilities.

The arrivals hall should allow unimpeded exit from customs. The essential facilities are: meeting point, currency conversion, hotel and tourism booking, hire car, ticketing for onward transport and car parks (remote and isolated payment stations are to be avoided), café, flight information, phones. The sizing depends on the same factors as the check-in hall, but the only long queues are likely to be formed by meeters wanting to be close to the entry point.

Airline offices are required for cabin service and personnel, aircraft line maintenance, managerial offices, flight operations, flight crew and cabin staff, secure and volatile storage. These activities might take 25 m² per EQA movement.

12.5 THE HANDLING PROCESS

12.5.1 Passenger Handling

The handling processes for passengers and their baggage can differ according to the characteristics of the passengers and the rules of the country. The most basic difference is the handling of domestic and international passengers due to differing border controls. There are three kinds of borders in Europe at present:

- borders between the countries of the European Union and the third countries - they have the same character as in the past
- borders between pairs of countries of the European Union - the movement of goods is free, the movement of persons is inspected
- borders between the countries within the European Union that have signed the Schengen Agreement - these are treated as domestic movements.

Other differences result from the customs, passport, safety and health regulations for individual countries.

Two basic check-in concepts are possible for departing passengers: **check-in for individual flights** and **common check-in**.

With the **individual flight check-in** concept the passenger for a particular flight can be handled at one or several counters reserved for that flight. The data on the passengers and on the flight

booking status, which are necessary for the bag loading, can be collected manually or taken from the reservation system. Often this procedure gives a shorter handling time per passenger, because it is not necessary to access the central booking system. Charter flights and LCCs particularly tend to use this type of check-in, but with few desks. The large number of bags and the use of few desks can result in long queues. In addition, the LCCs tend to board without seat assignment but by order of check-in, so the queue forms some time before the opening of the counter two hours before the flight. It is now becoming usual for the flight to close at check-in 40 minutes before departure, with some 180 passengers, all with bags, are required to be processed within 80 minutes using only two desks. Some LCCs are now charging for checked bags in an attempt to reduce the processing time, and some charter airlines are now asking passengers to arrive three hours before flight time. This means that some people will aim to arrive four hours before so as to be first in the queue, so adding to the congestion landside. It is clearly necessary for the airlines to use more desks even though that incurs extra costs.

With the *common check-in* concept, the passenger can check-in at any counter of the given airline, handling agent or even in any part of the whole terminal building which is suitably equipped. It requires computer technology to support this method of handling. Information on the passenger (flight booking status) must be available at each check-in counter. Computer technology allows comprehensive data processing in the course of the check-in process: seat allocation, data for aircraft loading, catering special requirements, etc. The advantage of the common check-in is an equal load on all check-in counters. Sometimes there is a relatively longer handling time of those flights which would have had short queues, and, if the handling agent provides the check-in, there may be a loss of identification of the passenger with the airline. The same counter is often used during the day by several airlines or handling agents. This is made possible by the CUTE system (Common Use Terminal Equipment), which provides access into the airline's host computer and to the Airport Operations Database (AODB). It needs a Local Area Network (LAN) infrastructure to allow data, video and voice transmission in both the public and the administration areas. The logo of the company can be displayed above the counter during the time it is actively using it. It may also be used by a single company with many flights, in which case the queue may take the form of a crocodile, particularly where the available depth for queuing is small. Passengers avoid being held up in a slow queue, but have to move their luggage forward many times.

The passenger handling process on departure is normally for the passengers to submit their air tickets and their passports at the check-in counter. This allows their booking status and identity to be checked. The checked baggage (the baggage transported in the aircraft cargo holds) will be weighed and, if the free weight limit has been exceeded, the appropriate fee will be charged. The weight of the baggage will be registered into the air ticket and baggage receipts stuck on the air ticket. The passengers will get their boarding passes. On some flights the airlines use a 'piece'

concept. In this case passengers are allowed to take one or more pieces of baggage of specified dimensions free of charge. All baggage consigned to the hold should will undergo a security check (e.g. X-ray). The security screening of baggage can be made before the check-in or directly at the check-in so that the passenger can participate in it. However, automated security checks can be done at any part of the baggage handling process. Some countries also require outbound customs inspection. After checking in bags, passengers then move through to the emigration passport control and security checks of the passenger and any carry-on baggage. They are then able to proceed to the departure concourse to wait until their flight is called. They may be called directly to the gate but, now that further security checks may be made before boarding and the number of passengers per flight is so high, they will more likely be called to a gate room where the final processing can be done in advance of boarding.



Figure 12-11 *It is expected that the self service kiosks will be used by up to 80% of short haul passengers (Photo: A. Kazda)*

In order to speed up the check-in process and decrease the requirements on the number of employees, an Automatic Ticket and Boarding (ATB) system has been introduced for passengers on some airports. By means of a touch screen the passengers can find out, whether there are free seats on the particular flight. The ATB machine will print out air tickets for the passengers, for

which they will pay by credit card, together with boarding passes with magnetic strips for entry to air side. ATB provides positive identification of the passengers and their baggage, the latter being taken to a 'fast bag' drop point nearby. The CUSS system is a common user version of ATB. It is expected that the kiosks will be used by up to 80% of short haul passengers and between 20% and 50% of long haul passengers (Figure 12-11). Where they are available, they are used already by 85 % of domestic passengers in the USA. There is not much evidence that they save space in the concourse, but they can be located in car parks, in hotels or downtown, as in Vancouver. It is now possible to perform almost all the tasks of a CUSS kiosk remotely with internet access to an airline's reservation system within 24 hours of flight departure. It may only be possible, however, to reduce staffing levels when e-ticketing is used by 25% of an airline's passengers.

The sequence of individual stages of the check-in process can be different at various airports. In some airports the central security check has been placed at the entrance to the check-in area and only those holding an air ticket are eligible to enter the check-in area. The system of check-in immediately after getting out of the car on the walkway in front of the terminal building, **curb check-in**, is common in the airports of North America. In this way, passengers are relieved of their baggage and may complete the check-in at the counter in the building. Many other combinations are also possible, including allowing check-in at the departure gate.

On arrival, the passengers first go through the passport control. The passengers can be divided into several channels, according to their nationality and visa regulations. For business or frequent travellers, the system of automated control is being introduced in some airports. On the first entry into the country and upon request, passengers are issued with an identification card, which, in addition to the basic passport data, contains also a biometrics description (e.g. dactyloscopic marks of the hand, face geometrics or iris characteristics). On later entries, a reading facility checks the biometrics of the passenger with the data on the card. A health control follows the passport control if necessary. After the baggage has been collected by the passengers on international flights they go through the customs. In order to speed up the customs inspection a concept of red and green exit is commonly used. The red exit is used by the passengers who wish to declare goods at the customs. The green one is used by the others, only spot checks being made. A blue exit can also be found at the EU airports. The EU nationals, to whom special customs regulations apply, use it. On exit from customs, a clear path is needed through the meters and greeters to the transport options. There should be as many options as possible: urban busses, coaches, metro, heavy rail, as well as pick-up zones in the short term car parks and taxis. It is helpful to have ticket facilities in the arrivals concourse, including fixed price vouchers for taxis to save the passenger in a strange country having to haggle with the driver over the fare.

It is, of course, necessary to find one's way between these processing points. Perfect wayfinding

will result in a minimum time for the journey. Any lack of wayfinding ability will increase the uncertainty in predicting the time needed, as well as increasing the average time taken. This is particularly important because a prime psychological concern is to eliminate the unknowns. Some of the uncertainty comes from the difficulty in estimating the effect of the possible barriers to processing and movement, and some from the difficulty in actually navigating through the terminal. It is recognised that the spatial logic of a natural line-of-sight progression in a straight path from ground to the aircraft and vice-versa is the ideal design. This is easy to provide when traffic levels are low, or if a decentralised 'gate-arrival' design is used to minimise walking distances. It is, however, very difficult to provide natural wayfinding in terminals for millions of passengers per year without the depth of terminal becoming prohibitive. This is the concept used for the design of the 8 mppa terminal at Stansted, but it is imperfect because all the ancillary activities which have to be fitted in on the single floor level impede the view, and also because the view of the aircraft is illusory in the sense that they are not accessible directly from the terminal but only from the remote satellite terminals via a people-mover. It has also been used in principle for the new Hong Kong airport at Chep Lap Kok for 30 million passengers per annum. The eye is, in fact, drawn to the airside end of the pier by a descending roof rather than a direct view of the aircraft. However, the forward motion is impeded by having to cross long check-in queues which form at right angles to the flow from kerb to aircraft, and by the need to change levels to access the people-mover.

When complex routes through a terminal become necessary, an efficient signing system becomes essential. Considerable effort has been put into understanding the best way of communicating information about flights to passengers, and into assessing the advantages of TV screens or large flip board displays relative to verbal announcements. IATA and ICAO have set recommendations for symbols to try to cope with the language problem, and most major airport groups have their own brands of shapes, colours and fonts, each specific to a type of sign: aeronautical, concessions, amenities, emergencies.

The signs can be static, e.g. for emergency instructions, or dynamic for check-in, flight, gate, bag claim and car parking information. Popular colours are black on yellow, red on white, and dark blue on white. The signs should not be more than 10 degrees from the natural line of vision and the lettering should be at least 1 cm high for every 3 m viewing distance. Despite these aids to design, some people still have to ask the way. The words 'departures' and 'arrivals' do not mean the same for everyone, nor is an upward-angled arrow or aircraft symbol always interpreted as a need to change level. There are also the perpetual problems of avoiding clutter with too many signs, differentiating between wayfinding and other signs, preserving visibility in crowded conditions with low ceilings, and assisting passengers who need to back-track. While it is reasonable for airports to gain revenue from advertising, it should not take attention away from the essential information. The new terminal at Vancouver uses lighting graduated in brightness towards the

nodes for subliminal wayfinding, and also uses the light fittings and carpet markings used as pointers. The BAA and some other airports provide helpful indications of the time required to reach batches of gates (Figure 12-12). With all these aids, there is still no substitute for being able to ask a real person, either directly or via a courtesy phone.

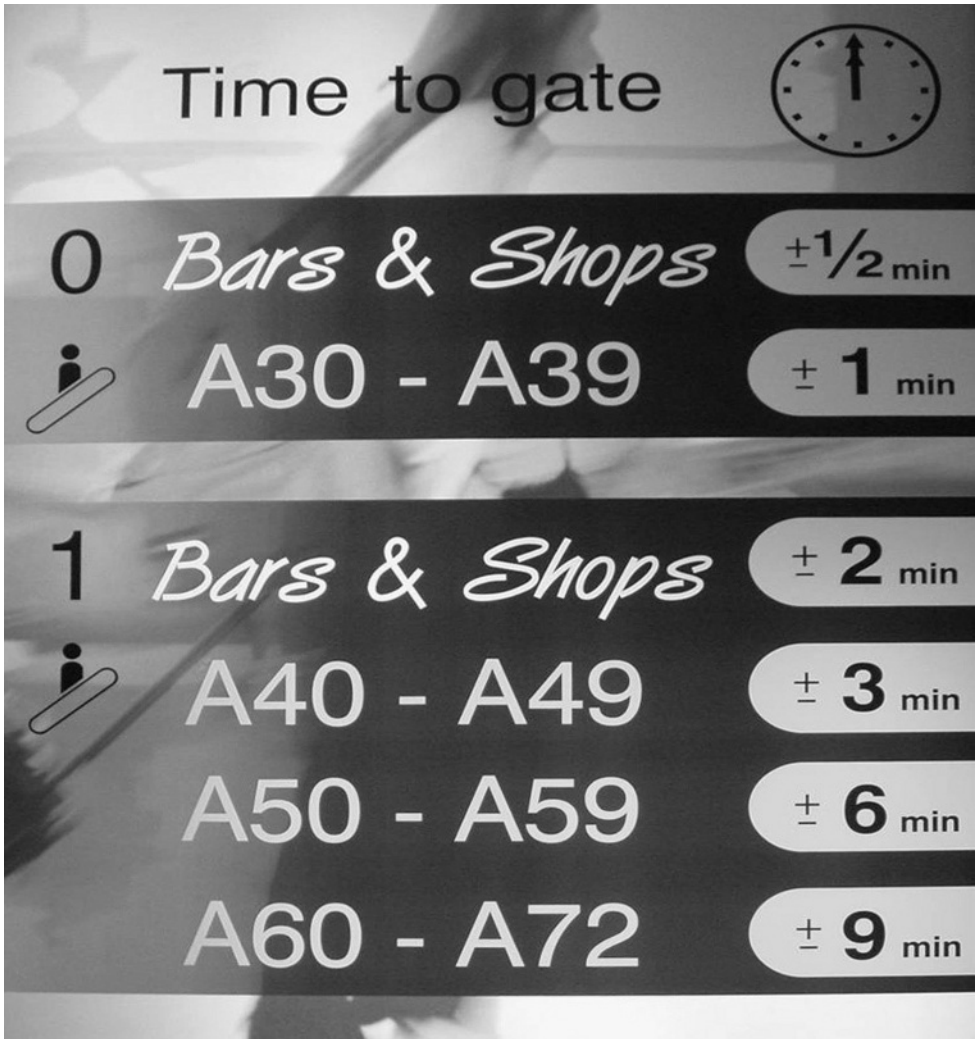

*Figure 12-12 Some airports inform passengers on the time required to reach a gate
(Photo: A. Kazda)*

Wayfinding and being processed are both more difficult for the disabled. New legislation requires airports to differentiate as little as possible between the disabled and the able-bodied. The ICAO

definition of a person with disabilities is ‘any person whose mobility is reduced due to a physical incapacity (locomotory and/or sensory), an intellectual deficiency, age, illness or any other cause of disability when using transport, and whose situation needs special attention and the adaptation to the person’s needs of the services made available to all passengers’. Up to 20 per cent of the first world population has a significant disability, plus many more who do not report their disabilities. Each type and grade of disability has its own set of ergonomic challenges.



Figure 12-13 Airports are responsible for the assistance of disabled and elderly passengers
(Photo: Courtesy Bratislava M.R. Štefánik Airport)

A new regulation strengthening the rights of disabled persons and persons with reduced mobility travelling by air was adopted EU Council in June 2006. The regulation establishes rules to protect disabled persons and persons with reduced mobility against discrimination and to ensure that they receive appropriate assistance. Under the regulation a reservation or boarding can only be refused for justified safety reasons or if, due to the size of the aircraft or its doors, the embarkation or carriage of a disabled person or person with reduced mobility is physically impossible.

The new rules make airports responsible for the assistance of disabled and elderly passengers from the point of arrival at the terminal through the whole process to the aircraft boarding without additional charges (Figure 12-13). Air carriers are responsible for providing assistance in aircraft,

including the carriage of recognised guidance dogs and up to two pieces of medical equipment per person. Air carriers and airport managing bodies must ensure that their personnel has appropriate knowledge of how to meet the needs of disabled persons and persons with reduced mobility, and should provide necessary training for their staff [145].

If it is at all possible, respect for the dignity of the disabled should be preserved, and this is best done by making it possible for them to use the same facilities and routes as other passengers by providing the same information and accessibility. Considerable progress has already been made in making physical provision by ramps (though these need a lot of space), large lifts and minimising changes of level, and now with aids to wayfinding. Some recent helpful initiatives are:

For the blind:

- synthesised voice calling out the floor and direction in all elevators
- tactile maps of the terminal.

For the visually impaired:

- high contrast flight information displays
- high contrast wayfinding information embedded in the flooring.
- audible warnings on travelators.

For the deaf:

- visual paging systems displaying text versions of audible announcements
- TDD service on public pay phones and at airport customer service points.

For the hard of hearing:

- amplified handsets on all counters
- induction loops
- public phones with sound boosters.

For all requiring carers:

- unisex washrooms in every cluster of washrooms.

Despite this progress, much more needs to be done if the disabled are really to be able to be as independent as the fully mobile.

12.5.2 Baggage Handling

Baggage handling is becoming a critical activity. The airlines are trying to shorten the turn round time between individual flights and at the same time, the average load factors are increasing. On big airports a long haul terminal may have an average of 210 passengers per aircraft. If the free baggage allowance of 20 kg of hold baggage per passenger is taken up, in the course of 40 minutes approximately 8 tonnes of baggage must be loaded and unloaded. One of the criteria for quality of service of the airport is the time passengers have to wait for baggage after disembarking from the aircraft and passing through immigration.

At small airports most of the activities connected with baggage handling can be carried out manually. The baggage is loaded on the baggage cart either directly or from the belt conveyor and dispatched to the aircraft, where they are loaded in the aircraft cargo holds. The baggage can even be handed directly from the baggage carts to the passengers on arrival. On medium size airports with the departure of several flights in the same time, sorting of baggage must be provided. Sorting can be done manually, when the baggage is picked up from the carousel by the handlers and loaded on the carts, or semi-automatic, in which case the operator will pre-select an appropriate branch to which the baggage will be dispatched, according to the baggage tag. In both systems, because of the human factor mishandling can occur, leading to a certain number of lost or mislaid bags, which damages the reputation of the airport. The 2005 SITA statistics (Jane's Airport review, October 2006) show that 30 million bags were mishandled at a cost of \$US 2.5 billion. For every 1000 passengers, 17 were delayed, 2.7 were damaged or pilfered, and 0.75 were lost or stolen. European hubs mishandled 15 to 20 bags per 1000 passengers compared with 6 in the USA. Contributory factors worldwide were:

- 61% transfer bag mishandled
- 15% failed to load
- 9% ticketing error/security
- 5% weather/space/weight restriction
- 4% loading error
- 3% tagging error
- 3% mishandled on arrival.

In large airports it is necessary to provide automated sorting of baggage. Automation can increase the capacity of a terminal building significantly and also improve the service standard. Automated sorting uses baggage tags with bar codes, magnetic cards or electronic chips for baggage and destination identification. Bar coding is the most frequently used today. In this case the tags are

automatically printed when passengers check-in. Reading of the code is carried out automatically by laser sensors, alternatively semi-automatically with manual laser sensors, and the data are stored in the database. The data are used for the baggage routing within the baggage sorting system. These data are also compared with the data from the database on passengers. This provides positive identification, called baggage reconciliation, to ensure that passengers have boarded the same aircraft into which their baggage has been loaded. If any passenger does not board the aircraft it is possible to determine exactly where the baggage is and unload it for security. On airports with a great number of transfer passengers it is moreover necessary to provide sorting and redistribution of baggage in a very short time in order to guarantee the minimum transfer times of the passengers. It may be best to provide sorting of transfer baggage outside the main terminal building, particularly for online transfers within an airline's hub.

Arrival bags are taken from the aircraft and placed airside on a continuous belt which carries the bags to the landside bag reclaim hall, either directly through the airside/landside screen or via a transfer belt which feeds a free-standing carousel with a sloping bed. Each carousel is assigned to one or more flights. The belt tracks are made long enough to present the bags sufficiently spaced to allow passengers to select their own bag without interference from other bags, i.e. the reclaim length is related to the size of the aircraft.

The baggage handling process still has a considerable human content, leading to many health and safety concerns. Amsterdam Schiphol airport has 2000 employees handling the bags for 44 mppa. It is with the automation of the unloading of the cart or containers when they arrive at the terminal from the aircraft by using tilting them to gently release the bags. It is also experimenting with automating the cart or container outbound loading by means of a robot. The bags are weighed and scanned for dimensions and orientation while the robot scans the container to decide where to put the next bag. It should be able to fill the container to more than 90 % while working at 15 seconds per bag (International Airport Review, Issue 1, 2006).

12.6 NON-AERONAUTICAL SERVICES

If we consider the needs of the passengers, it is necessary to realise that the main reason why most people come to the airport is not the airport itself, but because they want to get somewhere else. Most of the passengers are in a condition of emotive stress, even when they have already travelled by plane before. Therefore it is necessary to create a familiar and pleasant environment for the passenger, where he or she could relax and spend time before boarding. The airlines will provide this for premium passengers in their own lounges, but airports have seen the need to provide for all passenger types, and the opportunities that this brings.

At present many airport administrations achieve higher revenue from the non-aeronautical services. This is caused by several factors. One of the main factors is the need to increase revenue. The possibility of increasing revenue from landing and handling fees is in many countries strictly limited by the regulations of antimonopoly authorities and also by the strong lobbying of air carriers. At the same time the advantage of providing non-aeronautical services at the airports is that on the airports there is a high concentration of the more affluent members of society, and few of them is able to completely avoid some dwell time in the terminal before boarding the plane. Therefore during this time he or she can use shops and services, if they are some available and interesting, thus raising revenue for the airport and the concessionaires (the shop operators).

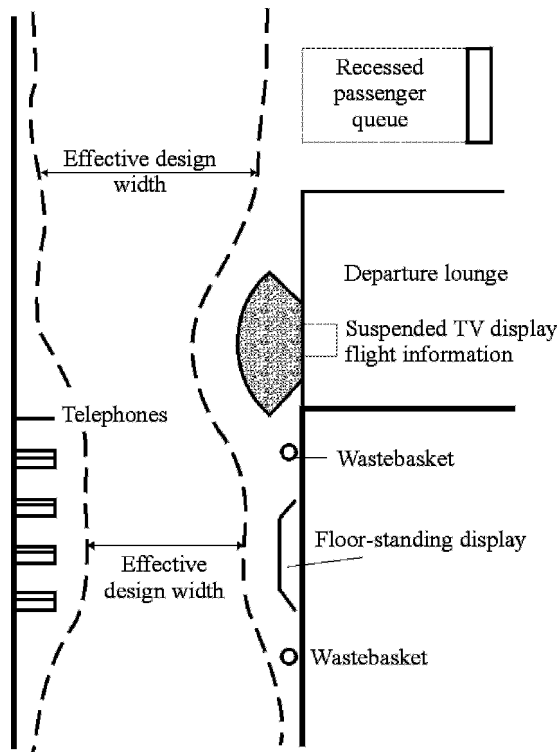

Figure 12-14 Public corridor effective width

The minimum provision of aeronautical services is explicitly determined by technological requirements and by the scope of the airport operation. The extent of non-aeronautical activities depends more on the space available at the airport, on the management philosophy and on the passenger volumes. Sometimes non-aeronautical services can reach such a level that they impede the handling process. For example, they can limit the capacity of check-in counters, interrupt the

flow of departing passengers (Figure 12-14) or their view of the location of toilets or departure gates. In spite of the fact that diversification and variety of offered services is required, non-aeronautical activities should never disturb smooth running and basic functions of the airport.

It is, however, possible to take advantage of the increased scope of services to make the airport operation easier. The offered activities can divert the passengers from the main circulation streams in the airport and help to distract the attention of the passengers from the problems and irregularities in the air transport system.

On some airports the traditional lay-out of the check-in process and non-aeronautical services is changing. Within the new concept of location of services in the terminal building the passenger, passing through the terminal, actually goes through the shops. Some say: 'This is not an airport any more, this is a shopping mall' however others claim: 'Only now it is beginning to be an airport'.

The needs and wants of the passengers gradually change. Typical passengers today expect to be offered more than last minute duty-free shopping at the gate. The passengers will require a wider range of services: hotels business services, and various catering possibilities of the same standard, quality and price to which they are accustomed in the High Street. Customers can choose from the same range of goods, brands and fashion goods. Airports have also provided additional services: fitness centres, super markets, cinemas, casinos etc., despite the additional floor area taken by these facilities. Security and flight delays have caused people to dwell longer in airports, causing problems for bored children, so many airports have installed play areas for children.

Though the airports' characters gradually change and become similar to the city centres, it is apparent that they will always differ by the scope of offered services, depending on the specific role within the catchment area (transit airport, origin/destination or hub airport).

12.7 PASSENGER TRANSPORTATION - PEOPLE MOVERS

The use of widebody jets at the end of the sixties necessitated extension of airports, particularly of terminal buildings. Greater wing spans required greater distances between the stands and longer walking distances for the passengers. On the other hand, economic pressures forced the airlines to increase the daily utilisation of aircraft and to shorten their turnaround times. At large terminals this necessitated the introduction of passenger transportation. Most of the means for transportation of passengers which are used in the airports were originally developed for transportation in cities. Some of them were improved or modified for use in the airports.

As mentioned above, there are internationally recommended maximum walking distances for the

airport buildings. Usually this distance is not supposed to exceed 300 m. If it is greater, it is necessary to provide assistance for the passengers. The second task of transportation facilities for the passengers in the airports is to minimise the connecting times between flights. The generic term used to describe all facilities used for passenger transportation in the airports is people movers.



Figure 12-15 People mover system, shuttle type, connecting airport buildings at Roma – Fiumicino (Photo: A. Kazda)

Terminals with a flow of up to 5 mppa generally do not require installation of people movers within the building. Though it might be desirable to facilitate movement of passengers on the airport, each people mover means an increase of investment costs in the construction of the airport. It means also an increase in the operational costs, particularly to guarantee the availability and reliability of a facility. Therefore, if it is acceptable for the passengers, there is a tendency to avoid the use of people movers in the airport, except for escalators and elevators to change level.

The choice of a suitable people mover system depends on:

- speed
- capacity
- safety and security.

Other criteria for the choice are usually these factors:

- transportation distance and elevation difference
- required frequency
- reliability
- ease of use by the handicapped
- ease of use with accompanied baggage
- maintenance requirements
- design characteristics
- procurement and operational costs.

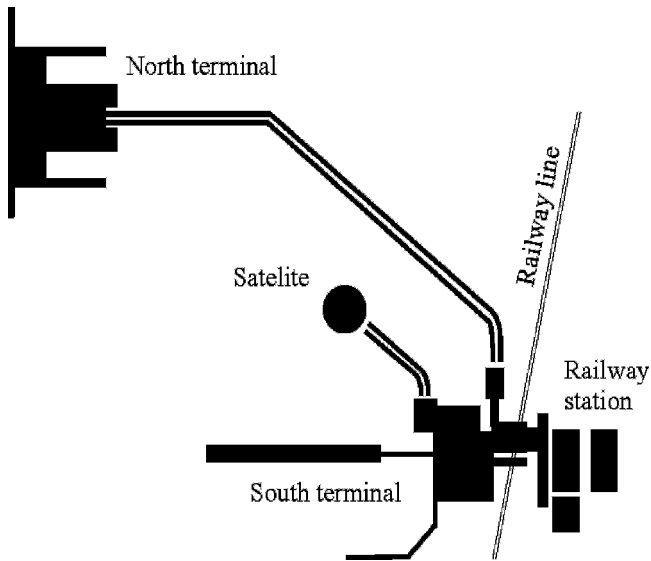

Figure 12-16 Scheme of people movers at Gatwick airport

For transportation of the passengers between the terminal building and remote stands on the apron or between individual buildings on the airport it is possible to use regular buses or special buses. The special airport buses used for the operation on the apron usually have a bigger capacity than regular buses. Because they have not been designed for regular operation on public services, they can be wider and have lower clearance. This makes it easier for the passengers to get in and out. In spite of the fact that special buses have higher capacity, sometimes the capacity of one bus is not sufficient. Therefore in Honolulu airport the system of 'bus train' is used, which consists of several

units with a drive and semi-trailers.

Some airports use mobile lounges to transport passengers between aircraft or a remote terminal and the central-processing terminal. The advantage of the mobile lounge is simplification of the passengers' movements. The passengers do not have to change level as when using buses. If all the stands on the apron have been designed as remote and mobile lounges are used for transportation to them, there are advantages of a quieter and less polluted environment in the terminal building as aircraft are usually parked on remote stand positions. The vehicle can be used as a holding lounge while it is docked at the terminal frontage. They do, however cost more than busses. All these special vehicles have implications for the design of the airside roads. In fact, whatever means of surface transport is used to access remote stands, there are serious implications for space, safety, pollution and minimum connecting times. One further option for connecting a central terminal with a remote pier, which does not involve people-movers or vehicles, is to bridge the taxiways as has been done at Gatwick with Pier 6 and also at Denver. The Pier 6 bridge spans 128 m, is 32 m high, and saves 50,000 coach trips per year in serving 3.4 mppa off 11 stands.

The simplest and also the most widely used types of people movers within the terminal building are escalators for overcoming changes in level and moving walkways for near-horizontal transport. Moving walkways are mostly used for distances up to 200 m. They usually do not significantly shorten the time taken to reach the aircraft. The usable distance is limited by the walkway speed, which usually must not exceed 1.25 m.s^{-1} . The length of walkway is also limited by the fact that it is only possible to get off of the walkway at its ends. Therefore several sections of walkways following each other have to be installed in the corridors to the gates. This is an incidental benefit when one section is out of action, in that the quality of service is not too seriously affected.

For transportation of passengers, flight crew, employees and visitors between individual buildings over longer distances at the airport, e.g. between terminal buildings (Gatwick, Kuala Lumpur), between a central terminal and satellites (Atlanta) or between the terminal building and a railway station (Birmingham) or parking lots, the use of walkways is not appropriate, because of their slow speed. Shuttle busses are the most common solution but, as the demand becomes greater, it becomes appropriate to use an automated shuttle type of people mover either on one track or on parallel tracks (Figures 12-15, 12-16).

They have been used for some time in the USA, at Atlanta, Seattle, and Miami among others. The first shuttle type people mover in Europe was installed at Gatwick airport. The part connecting the new satellite with the existing main terminal building and the railway station was built first. Later another route was built, which connected the south terminal with the new north terminal Figure 12-17).

A people mover with the highest passengers throughput is the system at Atlanta Hartsfield International, which transports more than 100 000 passengers a day (Figure 12-10). The system connects the four parallel satellite piers with the main terminal building. The people mover is located in a 1 600 m long underground tunnel together with the baggage transportation system and a walkway.

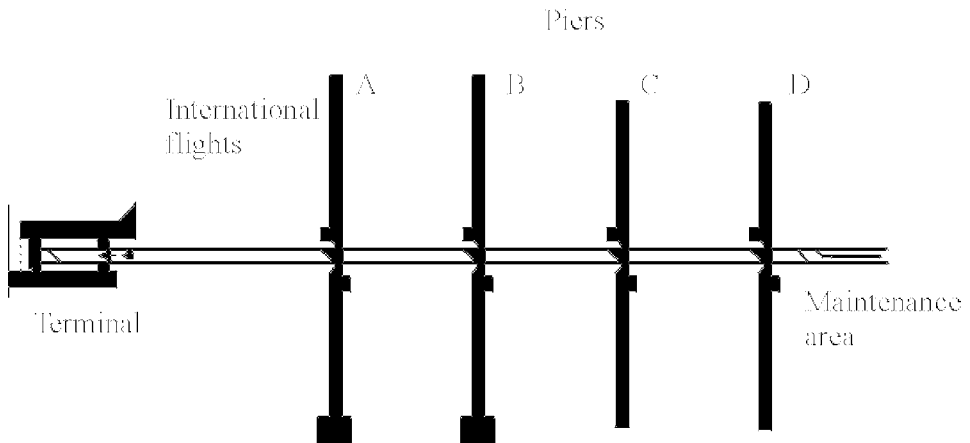

Figure 12-17 *People mover system at Atlanta Hartsfield airport*

The reliability of these types of people movers is usually higher than escalators or movable walkways, and are less vulnerable than busses to labour disputes. However, most failures bring the whole system to a halt, while a bus can easily be replaced. In the transportation peak the people-mover operates at set intervals. Outside the peak it may be possible to call the vehicle by a pushbutton as with an elevator. There are many different types of constructions and drives. The Westinghouse company uses fully automated carriages on tyres with electrical drive, while the OTIS company uses its own technology, which is used for elevators, the carriages being driven by a steel rope.

On large airports, providing surface transportation of the passengers is just as important as the air transport. Often the surface transportation of passengers at the airport is the bottleneck, which limits the airport capacity. This is considered further in Chapter 14.

13

SECURITY

Tony Kazda and Bob Caves

13.1 UNLAWFUL ACTS AND AIR TRANSPORT

The expression 'security' concerns all unlawful acts connected with civil air transport. The character and danger of unlawful acts change over time not only with the change of exterior, particularly political conditions, but the terrorists react also to the adopted measures for safeguarding the security of air transport.

The level of security provision is one of the important factors by which the airlines judge an airport. An aircraft of the American airline TWA was hijacked in Athens in June 1985. During the high-jacking one American national perished. Five months later the terrorists hijacked an aircraft of the airline Egypt Air to Malta. In order to achieve their aims, they started systematically to murder the passengers at regular time intervals. To rescue those who remained alive, a commando-style rescue operation was carried out. The result was 61 dead and 21 injured. The aircraft was completely burned out. After this event, American citizens were warned not to fly to Greece, since it was not capable of ensuring their security. The number of tourists from the USA in Greece decreased by half during the following tourist season.

With unlawful acts, the actual number of casualties is less significant than the threat that everybody who uses air transport could become this casualty. For example in 2005 just two people died as a result of civil aviation unlawful acts and one in 2006. One passenger died during an emergency evacuation of Saudi Arabian Airlines 747-300 in Colombo on 8th September 2005 after a bomb threat (no explosive device was found after a search of the aircraft) and one man who claimed to have a bomb in his cabin luggage was shot by an air marshal after he reached into his bag (American Airlines 757 flight on 7th December 2005 [143]. Is it possible to compare this with 39,189 people killed in car accidents in the USA in 2005 [63], or 12,658 murdered in the USA in the same year [147], or 93 people killed in US by lightning every year in average [148]? It is the violence and insanity of terrorist acts that is so macabre, together with the fact that the victims do not get the chance to defend themselves against these acts.

It is necessary to realise that air transport is not the real target of terrorists. The targets are ‘enemy’ countries and their governments, upon which the terrorists want to enforce a change in their politics. To attack the ‘enemy’ country, the terrorist does not have to risk performing sabotage activities on the territory of a foreign country. On the contrary, the terrorist can wait for the ‘country’, represented by an aircraft of one of its carriers, to come to meet him. The terrorist himself can choose the time, place and weapons for the attack. The aircraft itself may be worth several hundred million dollars. The unlawful act will become a central theme of the news bulletins of all television and radio stations of the world for several days, and in this way the terrorist will get the required publicity.

Terrorists are not the only source of threat. Others are: criminals, refugees, mentally unstable people, disgruntled employees and disruptive passengers.

The first recorded unlawful act in the history of aviation was the hijacking of an aircraft in Peru on the 21st February 1930. The hijackers seized the Pan American Airways Fokker F7 and used the plane to drop political leaflets [126]. The first casualty of an unlawful act was the pilot of a Romanian aircraft which was hijacked in July 1947 during a flight from Romania to Turkey. The third case happened in April 1948. Seventeen hijackers from Czechoslovakia, among them two crew members of the plane, forced the plane to land in the American occupied zone of Germany.

Hijacking of aircraft was practically the only type of unlawful act until 1969. The hijacker needed the plane as a ‘means of transport’. The highest number of hijacks was from the USA to Cuba [126] when Fidel Castro’s regime used it as a special combat tactic against the ‘US enemy’. It is evident from the analysis of hijackings that there was a close dependence between the state policy limiting the free movement of citizens and the number of hijacks. After opening the frontiers the probability of ‘traditional’ hijacking decreased.

Where the politics cannot be changed, measures have to be introduced to counter the terrorists. The number of hijacks in the USA decreased substantially after the introduction of security measures. The measures included manual inspections and checks of passengers by metal detectors and inspection of their cabin baggage. The checks were supposed to prevent the would-be hijackers from carrying weapons onto the aircraft.

After 1968 the character of unlawful acts started to change. Terrorists began to use hijacking of planes to enforce their demands rather than for transport. Hijacking was a suitable tactic for terrorists because:

- the passengers and crew were suitable hostages
- the aircraft was a suitable, safe and temporary mobile prison for the hostages
- it was possible to place demands upon authorities through the media that monitored the case.

The countries in the Middle East and in Europe were not able to react quickly and effectively to hijacking and they were slow to recognise the problem represented by transit and transfer passengers. In Jordan at Dawson's Field three aircraft were destroyed on the ground by Palestinian terrorists in 1970. This led to the introduction of X-ray screening.

Terrorist tactics changed after 1986. Increased security measures at the airports made it more difficult to carry the weapons onto aircraft. Therefore the terrorists adopted methods which were easier and safer for them. Before 1986 sabotage as a coercive measure was seldom used. The difference from hijacking was that sabotage did not make it possible to keep hostages, to state conditions and to blackmail authorities. Those sympathising with the terrorists realised that they could also become victims. The responsibility for the committed crime could also be claimed by other 'rival' terrorist groups. In this period, sabotage, as distinct from hijacking, was considered to be a condemnable act also in the countries where the terrorists came from.

From the beginning of the 1980s the number of unlawful acts decreased but their character and the consequences of the terrorist actions became more severe. The formation of fundamentalist groups supported by extremist countries changed the situation. Terrorism became an integral part of political and ideological struggles. Terrorists began to use sabotage and sabotage threats against aircraft and airports as coercive measures. Aircraft were destroyed in the air and on the ground. In Sri Lanka a bomb was placed in the aircraft tail during refuelling; there were massacres in the check-in concourse at the airports of Rome and Vienna in the period before Christmas; there were explosions of an Air India 747 off Cork in Ireland, a Korean Airlines 747 above the Andaman Sea, a Pan Am 747 over Lockerbie in the UK and a UTA aircraft in the desert between Chad and Niger.

The original measures used against hijackers proved to be insufficient against terrorists. The

terrorists used more sophisticated means including highly effective plastic explosives, firearms made of plastics and composites and masked bombs. The measures for ensuring security were therefore complemented by inspections of all registered and hand baggage, air cargo, galley equipment, mail etc. Airport employees were included in security inspections and also all other persons that entered the air side area of the airport. Computer controlled systems were used to an increased extent for inspection of authorisation of entry into specific areas. Also hitherto accessible parts of terminals, workshops and maintenance areas on the airport were hereafter included in the security cordon. The checked luggage had to be reconciled with the passenger before the aircraft could leave the stand.

A threat of a different type is by mortar bombs on airports from beyond the exterior perimeter of an airport. The first mortar attack on an airport was launched in January 1975 on Paris - Orly airport. After the Irish Republican Army mortar attacks on London Heathrow airport in March 1994, it seems that increased attention must be also paid to the land around the airport, particularly to the car parks or unattended areas.

A new type of attack was used by terrorists on 11 September 2001. Four aircraft were hijacked, two B767s and two B757s. Two of the aircraft were flown into the World Trade Centre Towers. Another aircraft was flown into the Pentagon complex collapsing part of the structure. The last one crashed outside Pittsburgh, the hijackers having been challenged by the passengers. During these unprecedented acts, where al-Qaida extremists used aircraft as weapons, thirty three crew members, two hundred and fourteen passengers and nineteen hijackers were killed, as were thousands of people on the ground [143]. After September 11, new security measures were adopted to enhance security including air marshals (sky marshals) presence on board some airlines. U.S. Department of Transportation recommended cockpit doors be reinforced in order to deny access from intruders. At U.S. airports, only passengers with valid air ticket were allowed beyond the security points (except with special medical or parental needs), each passenger could take one cabin bag only, all electronic items, e.g. laptops and mobile phones were subjected to additional screening, there was a limit on the amount of jewellery or other metal objects that passenger could wear and travellers had to remove all metal objects prior to passing through the metal detectors to facilitate the screening process.

Another type of threat to commercial airliners are shoulder fired surface-to-air missiles (SAMs) sometimes designated as man-portable air defence systems (MANPADs). The SAMs were developed at the end of 1950s for protection of military ground forces against combat airplanes and at present there are about 350 000 to 500 000 in the military arsenals worldwide [28]. There are no accurate statistics on the SAMs attacks on civilian airliners as most of the cases were from war zones where civil registered airplanes operated as military transport aircraft. It seems that about twelve civil airliners were shot down since 1978, most of them in Africa.

There have been two recent attempts to shoot down an airliner since 2002. The first one was on the Boeing 767 of Arkia Israeli Airlines in November 19, 2002. The airplane was departing from Mombasa – Kenya when two SAMs were launched by al-Qaida terrorists in the airport vicinity, but fortunately both missed the aircraft.

The second was during a DHL operation from Baghdad airport (Iraq). On November 22, 2003 the Airbus 300 DHL express courier service was stricken by a shoulder-fired missile which damaged the left wing. The pilot was able to fly and land the aircraft only by controlling the engines.

There are different types of SAMs on the black market from Soviet production like SA-7, SA-14, SA-18, as well as the U.S. Stinger, French Mistral or Chinese FN-6, and plenty of other types. Typically they have a target detection range of about 6 miles and an engagement range of about 4 miles, so aircraft flying at 20,000 feet (3.8 miles) or higher are relatively safe [28]. There are different systems of SAMs guidance and control. The infrared (IR) missiles use passive guidance and depending on the year of production they could be from the first to fourth generation. The IR missiles are most popular among terrorists and sometimes are referred to as ‘fire and forget’. The Command line-of-sight (CLOS) missiles must be flown by a operator who visually aims the target. They require a properly trained and skilled gunner. Laser Beam Riders use laser for missile guidance to the target. These missiles are resistant to all currently known countermeasures.

Unfortunately there is no single solution to mitigate the SAMs threat to civil aviation airplanes. To enhance aircraft protection and security, a combination of on-board countermeasure systems, air traffic control procedures, pilots training and strengthening of airport and local security measures might be used.

The advantage of the terrorists is that they themselves choose the manner and time of fighting. It is difficult to presume what the future weapons or type of an attack of terrorists will look like. State sponsored terrorists have access to technically sophisticated weapons and they go through professional training, which enables them to overcome more and more sophisticated counter measures.

As a response to a new threat identified in autumn 2006 it was necessary to further tighten security rules at airports concerning the items in carry-on baggage. For a short time after a security alert in August 2006 in the UK, severe limitations were put on the size of bag that could be carried through to the aircraft, together with a total ban on liquids. This caused huge delays. A further requirement was to take off shoes and have them passed through the X-ray machines. Some airports, like Dallas/Fort Worth, provided disposable slippers to encourage passengers to take their shoes off early, as well as bags to dispose of banned substances. These restrictions caused big bottlenecks to occur before the X-ray screening, at the magnetometers as boarding passes were

taken through and after the screening while shoes and coats were replaced.

In November 2006 new rules were introduced in the UK and a few days later also in other states raising the limit on size to 16 mm x 35 mm x 45 mm and easing the amounts and types of liquids in the cabin baggage. Most liquids were banned from cabin baggage and they could not be taken through security checkpoints. The ban included drinks, toothpastes, perfumes, shampoos, hair gels and other similar items. These items were permitted through the security screen only in small quantities within separate containers, each of a capacity not greater than 100ml. Containers had to be brought to the airport in a single, transparent, re-sealable plastic bag, with capacity not more than 1 litre. Each passenger was allowed to carry only one bag of liquids. Passengers were also prohibited from taking aerosols through security checkpoints. However, passengers could purchase most of these items at the airport shops after the security points.

As has been mentioned, the purpose of most of the attacks against civil aviation is to create political pressure on individual governments. The government politics directly condition the level of threat to civil aviation and a single unwary declaration of a high government representative can mean an immediate threat of terrorist attack with extensive negative economic consequences for airports and civil aviation in general. The protection of civil aviation must therefore be an integral part of the national security plan of each country. It is illogical that the protection against unlawful acts be paid by airports, airlines or passengers, who themselves are jeopardised as a consequence of the political attitude of the country. Moreover, under international law the governments must ensure protection for all companies and individuals that are on its sovereign territory without any discrimination. In spite of this, most costs in connection with ensuring the security of civil aviation are born either by airport administrations or by airlines. In the long run, the costs are transferred onto the final users - passengers. Some airports have a directly specified security charge.

The threat of unlawful acts is at the same time a very effective way of waging war against another country. It is estimated that the total damages to USA civil aviation in connection with the war in the Persian Gulf exceeded the costs spent on military actions.

International cooperation and standardisation is important as well as coordination of procedures between individual countries in order to ensure the security of civil aviation. The issues of security were for the first time addressed at the international level in the agreement in Tokyo in 1963, which deals with the issues of acts 'disturbing the security of aircraft or travellers'. The growth of politically motivated terrorism and unlawful acts in the sixties were addressed by the Hague Agreement of 1970. The Montreal agreement of 1971 dealt with acts of sabotage. ICAO standards for security issues are dealt with in Annex 17. Annex 17 was published for the first time in August 1974. Since then it has been amended when necessary. It requires countries to have a National

Aviation Security Programme (NASP). The host country has the responsibility for:

- the airside/landside barrier
- control and use of identification (ID)
- central screen of passengers and baggage
- control of sterile area
- ramp security
- armed reactive force
- effective communication
- control of area overlooking the airport.

The method of ensuring the security of civil aviation is different from country to country. For example, the responsibility for security of airports could be divided among three parties:

- the government being in charge of inspection of passengers and their cabin baggage
- the airport being in charge of airport areas behind the security check and the whole premises of the airport
- airlines assuring compatibility of individual registered baggage with passengers and security of their own ground equipment.

The UK NASP is managed by the Department for Transport's Security Division. It requires each airport to have an Airport Security Committee with a programme approved by the Secretary of State through a team of inspectors. The airport must identify potential threats, estimate the probability of attack, assess vulnerability, and identify exploitable features and the probability of their exploitation.

In the EU the aviation security is ruled by the Regulation 2320/2002 of European Parliament and Council on Common Rules in the Field of Civil Aviation Security and by the ECAC Policy Statement in the Field of Civil Aviation Security ECAC.CEAC Doc No. 30. These norms were complemented and amended several times in reaction to topical security issues. They will again be replaced by new norms in the near future.

13.2 THE AIRPORT SYSTEM AND ITS SECURITY

Fast changing security threats require different design and construction of terminal buildings and

other areas of the airport. The earlier terminals seldom comply with today's requirements. Old terminal buildings mostly do not allow separation of departing and arriving passengers, so that temporary solutions have to be adopted in order to separate the flows of passengers. It is also problematic to estimate which security requirements will have to be met in the future. It is therefore necessary to design the terminal buildings with the maximum flexibility.

Measures to combat unlawful acts required substantial intervention into the check-in process and into the design of the airport terminal, which originally had not been taken into account. The first measures consisted in setting up security control of passengers and their cabin baggage in the gate, immediately before boarding the plane, or alternatively directly before boarding the plane upon the exit from the gate. For flights with special security requirements, the inspection of checked baggage was carried out bag by bag. Sometimes, the baggage was reconciled with the passenger on the apron before boarding. It was possible to hold the air cargo in the warehouses for some time to eliminate the possibility that a consignment with a concealed explosive and timing device would be loaded onto an aircraft. However, these measures turned out to be impractical. When the inspection of the passengers took place at the gates, there was often a delay to flights. Decentralised check locations had to be established at the entrance to the holding area for each gate. This increased demands on personnel at the check points and on their technical equipment requirements. The queues of passengers before the security control prevented other passengers from moving freely.

Therefore the centralised system of security inspections tends to be given preference in the design of new terminal buildings. Thus, by the time the passengers reach the entrance to the gate (or to the transit concourse) they will already have passed through one or several security filters. The centralised system has several advantages:

- passengers inspection is carried out before the entrance into the airside circulation area, so the passengers do not have to wait until their flights have been announced
- the flow of passengers through the security inspection is substantially more stable with smaller peaks than at individual gates
- there is higher utilisation of technical equipment and personnel.

The centralised security inspections have also their disadvantages:

- corridors or concourses to the gates must be kept security-sterile
- the security-sterile area must be equipped with the required services
- before entering the sterile part all employees and goods also have to be checked
- people accompanying the passengers are prevented from having free access to the whole

terminal building; this decreases the commercial use in that part of the terminal. Exceptions need to be made for elderly and handicapped passengers, who, at least in the USA, are accompanied by the dependants up to the entrance to the aircraft.

In some airports, where it is necessary to introduce a special security mode, the preliminary security inspection of all persons is carried out immediately on their entrance into the check-in hall. Sometimes the checks are even in front of the terminal and only passengers with valid air tickets are allowed to enter the building.

Security requirements are often contrary to the architectural intentions of the design of the terminal building. Balconies, terraces and entresols, which divide the internal area of the building in a suitable way, could be convenient observation points for the terrorists, or a place from where shooting could take place. In the event of a bomb attack, large glass areas, providing natural light, can be very dangerous. Glass shards are a source of extensive injuries. All glass in these areas should be toughened and secured firmly to a robust structure. A blast which would do only superficial damage to a modern framed construction would cause moderate damage to load-bearing masonry. In the check-in hall and in other passenger areas, controls should ensure that it is difficult to leave baggage which might contain a bomb. A particularly easy place to leave a bomb is inside a rubbish bin. They should therefore be transparent or, as is the case in Copenhagen, bombproof so that the horizontal blast wave is negated.

Some older airport terminals have been combined with car parks (e.g. Toronto, Charles de Gaulle - Aéroport 1). If a car were to be placed there, and the explosives it contained were detonated, there would be extensive casualties and damage. In a period of increased danger of terrorist attacks, the floors of the garages directly adjacent to the areas for the passengers must be closed to the users and modified so as to limit the spread of the detonation wave. In the design of new airport premises, the parking places should principally be located with no direct contact to the terminal building, whether they have been designed as parking lots in the open or in multi-storey garages. However, it is necessary to find a compromise, so that the walking distance does not exceed the IATA recommended limits. At the same time it is necessary to provide inspections of parking places, not only to provide security, but also for prevention against theft.

It might well be advantageous for a terrorist to place an explosive in the left-luggage rooms of a terminal building. Therefore, the baggage must be checked before accepting it into custody. If the airport uses lockers for baggage, they should be placed outside the terminal building.

For flights with special security requirements, it is appropriate to reserve one part of the check-in counters with a separate entrance for the given flight. The counters must be physically and visually separated from other parts of the building. The formation of a queue in front of the

entrance to the counters must be eliminated, so that no attack could be made against it. In some airports, a whole terminal has been assigned to flights with special security requirements. This gives the possibility to provide increasingly complex security standards, but there is a clear demarcation of the premises which makes the target obvious to the potential terrorist.

It is necessary to pay special attention to maintaining security during construction or reconstruction of the airport premises. The workers of construction companies are sometimes not too willing to undergo the security measures. It is very difficult to find out whether they are criminally unimpeachable. Because of a generally high turnover of staff, it may not be difficult for a terrorist organisation to infiltrate their members into a construction company. Inspection of material movement is made difficult by a great number of cars, lorries and other delivery vehicles. The only solution is a consistent separation of the areas where the work takes place from other premises of the airport. Even then, it is not possible to exclude the possibility that weapons or explosives might be smuggled into the airport and placed there for later use.

An increased effort to maintain security must also be made during emergency situations in the airport (fire in the terminal building, emergency landing of an aircraft, etc.). Emergencies can be evoked intentionally in order to distract the attention of security units from a terrorist attack.

13.3 SAFEGUARDING OF AIRPORT SECURITY

13.3.1 Security as a Service

In civil aviation, safeguarding security has to be considered as a service to passengers. A feeling of safety is one of the basic needs that must be satisfied. However, what one category of passengers considers as adequate safeguarding of security, e.g. families with children, can be considered as a useless nuisance by other groups, e.g. business passengers. Therefore a compromise has to be searched for, between the level of safeguarding security, the time required for security inspections of the passengers, and the money costs. The required security standard has to be guaranteed in the airport. On the other hand the airport operation must not be paralysed, nor must the high quality of service of air transport be affected by disproportionate prolongation of the check-in process with the introduction of strict and time consuming security inspections.

The system of safeguarding security is individual in each airport. It will be different on large international airports such as London Heathrow, New York J.F. Kennedy or Amsterdam Schiphol from small airports serving perhaps two or three holiday charter flights daily.

At small airports, the application of basic standards might be inconsistent and their implementation might be practically impossible. In such case the state has the option of applying alternative rules

for providing an adequate level of security protection. A 'small airport' is defined by the EU rules as an airport:

- a) with a yearly average of 2 commercial flights per day; or
- b) with only general aviation flights; or
- c) with commercial activity limited to aircraft with less than 10 tonnes of Maximum Take Off Mass (MTOM) or less than 20 seats [69].

However the requirement has always to be the same, namely to prevent the possibility of locating a bomb on board the aircraft or to prevent the airport premises being penetrated or aircraft being boarded by a group of terrorists.

The manner of safeguarding security will depend on the scope of the airport operation, individual destinations, airlines, kind of operation (scheduled, chartered or general aviation) and the airport size. In designing the airport protection, it is necessary to consider the following:

- protection of the airport perimeter, aircraft on the ground whether in hangars or on movement areas of the airport, operational facilities, stores and terminals
- limitation of movement of persons and vehicles into security sensitive areas on the airside
- security checks of passengers and employees
- control of movement of passengers and separation of arriving and departing passengers.

13.3.2 Airport Perimeter Security and Staff Identification

The standard of safeguarding security on the manoeuvring area and other areas of the airport depends on the reliability of monitoring access to the airport and identification of the employees. It is necessary to emphasise that there is no security system which cannot be beaten. Modern protection of an airport perimeter rests above all in technical installations, which can identify the place and manner of breaching the perimeter with high accuracy and reliability. At the same time, overcoming an obstacle requires a finite time during which it is possible to send a security commando to the place of violation.

On small airports in the third world countries, the outside perimeter of the airport covers several kilometres, and it is very seldom protected by a high quality fencing. On some airports in Africa, this has even allowed attacks of organised groups on the cargo holds of aircraft while they were standing in the queue and waiting for permission to take off. However, the large open space on the airside of airports allows the threat to be visible, at least in daylight, and provides in this way enough time to identify the intruder and to respond before they can threaten the terminal area. It is

possible only to hope that the security commando has been properly trained and motivated in order to be able to control and defend the apron and the terminal building.

Figure 13-1 DTR 2000 - fencing for areas with high security needs

Since the number of workers is in most cases low on such an airport, their identification by means of simple cards, possibly with colour differentiation for authorisation of entrance into the specified areas, will be sufficient.



The protection of the airport perimeter is decisive not only for safeguarding the security but also for safety. Perfect fencing prevents penetration of animals to the movement areas and their possible collision with the aircraft. Airport perimeter fencing fulfilling both security and safety functions is required by Annex 14, Volume 1, Chapter 9 and also by the Doc 30 - ECAC Policy

Statement in the Field of Civil Aviation Security [72]. A higher security standard is required in large international airports, or at least of some premises in such airports (Figure 13-1). The required standard cannot be usually achieved by common fencing. In order to secure the more important facilities like fuel farms, transformer stations or control towers barrier type protective systems have been used, as well as other types of systems which function on different physical principles. The quality of security of a system is measured by the probability of intrusion of the protected facility without identification of the place and time of intrusion. The quality of security is one of the most important parameters for judging the level of safeguarding a facility and can be expressed mathematically.

The probability of system intrusion is in particular affected by:

- number of false alarms in relation to the unit of length and time (e.g. to 1 km of length in one month)
- reliability of the whole system (depends on the reliability of individual parts)
- monitoring of the condition of the security system
- raising the alarm upon failure of basic functions of the security system.

The intruder can be successful in overcoming the security system, if at the same time four conditions have been fulfilled:

- perfect knowledge of the system (mechanical construction, physical principles and software) by the intruder
- sufficient time and ideal working conditions
- availability of special tools and facilities, which are not normally carried by people
- upon unsuccessful first attempt there is a possibility of an unlimited number of other attempts.

When selecting a security system, the structure has to be judged also from the point of view of the effect of the environment on its function. Again, there is no perfect system. A system suitable for one locality can be, from the point of view of physical principles on which the system functions, inapplicable in another locality.

- A **microwave system** is unreliable on uneven terrain or if there is vegetation (e.g. grass, shrubs) in the detection zone. It can be easily penetrated in the vicinity of transmitter and receiver - without being discovered the intruder will crawl through under the microwave beam.
- In the **electric field system** the shape of electric field will change if a large body comes close to it. This change will be recorded by wire sensors. The basic requirements of faultless operation are perfect suspension of the system, ensuring the correct distances between the top wire and

the earth and the prescribed stretching of wires. If these conditions are not met, false alarms take place.

- **Systems sensitive to pressure** or deformation record the changes in mechanical load on the soil when a person walks above the sensor. False alarms arise by the movements of surrounding trees and poles (due to the wind) and precipitation phenomena (rain, hailstorm).

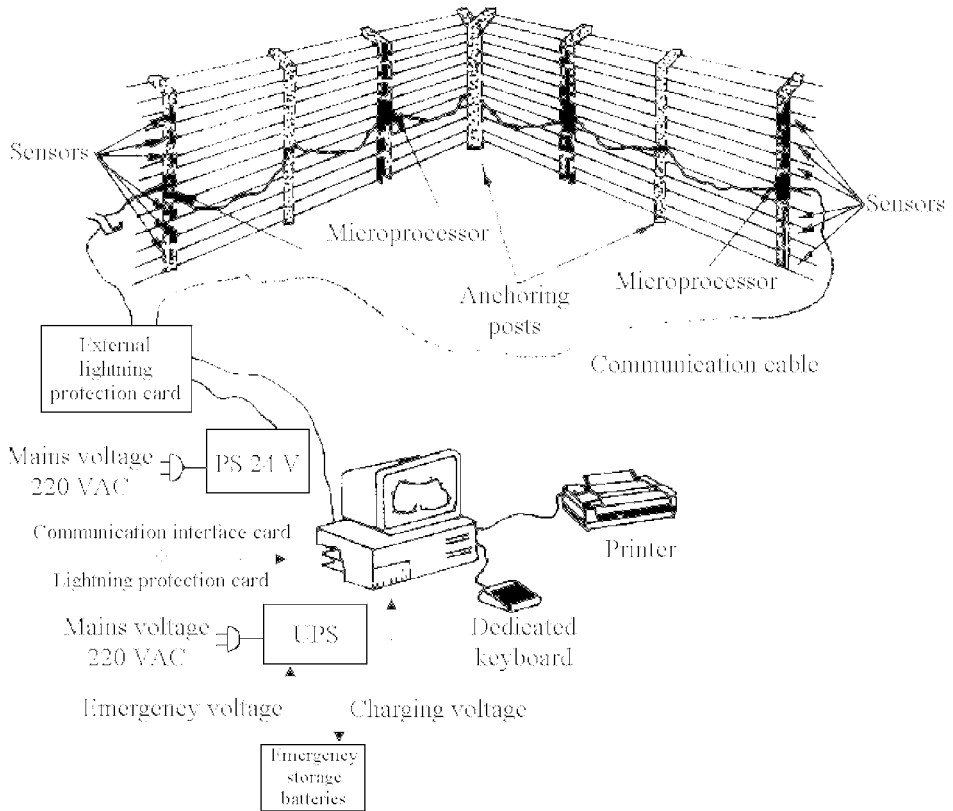

Figure 13-2 *DTR 2 000 system configuration*

- **Infrared radiation** (the so called infragates) systems are sensitive to fog, which changes and disperses the infrared beam. Similarly their functioning is affected by dust and by rapid changes of temperature which can condense water on the sensors.
- **Vibration or deformation detectors** can be installed on the finished fence and record vibrations of the fence evoked by intruders. The system is sensitive to false alarms evoked by wind, hailstorm etc.

It would theoretically be possible to create a perfect, insuperable system by combining various security elements. However this is practically not possible. By integration of several components into one unit the number of elements increases and the reliability of the system decreases. The number of false alarms increases and the integrity of the overall security system decreases. Moreover, by integrating several systems the price of the security provision increases. None-the-less, the New York Port Authority airports of J F Kennedy and La Guardia have radar (costing \$140 million), infrared imaging, surveillance cameras and motion detectors.

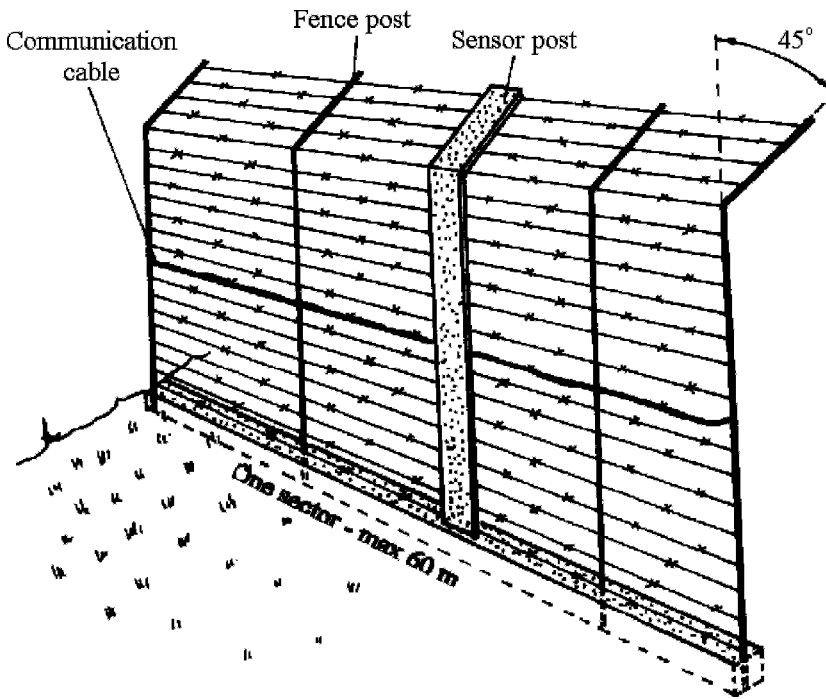

Figure 13-3 A part of the DTR 2000 barrier

The highest quality and security standard is represented by the security perimeter systems of the Israeli firm Magal, which were tested practically in challenging operational conditions. The manner of detection of the intruder is based on an electromechanical system controlled by a computer. The sensors are placed on the fence posts. They are mechanically connected to the whole barrier which is made of special barbed wire. The sensors detect any activity on the fence: cutting, climbing, spreading the wire, attaching of any object. If a force greater than 150 N is exerted, the alarm is raised with the precise specification of the place of intrusion on the operator's monitor. The DTR 2000 system, which is the system with the highest security, achieves a false

alarm rate of once in 3 months within 1 km length of fence (Figures 13-2, 13-3).

In order to prevent the crossing of the barrier by means of a 'high bridge', it is possible to increase the level of detection by installing an independent camera system monitoring the protected area parallel to and within the guarded line.

Each Magal system contains an automatic meteorological unit, which scans meteorological data. On the basis of measured values of wind and outside temperature the computer sets the threshold sensitivity of sensors, which decreases further the number of false alarms.

Whatever systems are used, there should be a physical inspection and search at least every day.

It should not be possible to cross the airside/landside barrier via plumbing ducts, air vents, drains or utility tunnels.

The sorts of place which might be identified as particularly vulnerable are gate posts, rivers, power plants, control tower, centralised air conditioning, the approach lighting system, emergency access routes and the drinking water reservoir. These should all be monitored by CCTV in a central security control centre.

The security network should link the following systems: check-in questions; biometric access control; production of passenger ID bag screening, status, reconciliation; intruder detection; CCTV infra-red; car park number plate recognition; passenger and staff security displays. The communication network should be able to survive the failure of any single cable or support system, terrorism interference at one or two points, extra high demand and an aircraft accident.

In the event of an incident with an aircraft, there needs to be an isolated parking position and a blast-containment area. The airport design should minimise places where devices may be concealed. Lighting should be such as to allow guards to see intruders but conceal guards from them.

13.3.3 Employee Security Procedures

On all bigger airports it is necessary to ensure computer control of authorisation of entrance of employees into specified areas of the airport. The mostly common manner of inspection is the use of magnetic or chip cards. At the entrance point, the employee pulls the card through the slot of the reading device. The authorisation of his or her entry into the given area will be checked and entrance will be permitted or refused. At the same time it is possible to register the entrance or leaving the given area and the movement of the employee on the airport. If security is violated, it

is possible to evaluate retroactively the presence of the employee on the airport. The system should also monitor forced intrusion into the guarded areas e.g. through the fire door. It must also enable the inspection of validity of the cards. Cards with limited validity, e.g. issued to part time workers, building workers or concessionaires, must be refused entrance into the protected area after expiration of the validity.

Inspection of the entrance into sensitive areas from the security point of view can be tightened by the combination of the security card with the personal code of the employee, the Personal Identification Number (PIN), which has to be typed on the keyboard after the card has been inserted into the reading device. This will limit the abuse of the card if it is stolen.

Identification of an employee in highly sensitive areas can be further enhanced by the implementation of biometric signs (dactyloscopic signs of the hand, voice identification - voice spectrum upon pronouncing of the password, scanning the iris or face geometrics) or by comparison of the portrait of the worker scanned by CD camera with the picture stored in the database etc. Some firms offer chip identification cards which can be read at some distance from the scanner. Such systems or cards are still more expensive.

Acquisition and operational costs can be reduced by decreasing the number of inspection points into the building. Then it is possible to combine the computer systems for the identification of employees with the control systems of the buildings, which fulfil other functions such as fire alarms, control of the heating, automatic switching off the lights in case of absence of the worker in the workplace etc, i.e. the building management system.

The computer systems for identification of the airport employees and securing the airport are becoming much cheaper and so allow the numbers of security service workers to be reduced. At the same time the costs of maintaining the system increase, while reducing the number of workers can be the source of conflicts with the unions in some countries.

In EU countries, airport identification cards can be issued only after a minimum of a 5-year background check has been conducted [72]. In some countries, a 20 year background check is required when employing airside workers, whether by the airport or by the concessionaires.

Should the screening fail, any possible contact of the airport employees with terrorists when, for example, cleaning aircraft, can be made more difficult by random rostering of workers into work groups with the use of a computer program.

13.3.4 Measures in Relation to Passengers

One of the important measures for increasing security is complete separation of arriving and departing passengers. In the Schengen countries' airports a system of one point security screening is assumed e.g. passengers screened at one Schengen EU airport can mix after arrival with screened departing passengers. At many airports in the third world countries, the security measures are insufficient and smuggling of the weapon or explosive on board the plane could be easier than in the countries with a controlled level of security measures. After arriving from such a country, the terrorist could hand over a weapon to his accomplice, who had already gone through the security inspection. Separation of flows of arriving and departing passengers makes it radically more difficult to hand over a weapon or any other inadmissible material to another passenger.

It is also common to generate profiles of passengers to differentiate the scope of the security inspection. It is obvious that it is necessary to pay more attention to two men coming from a country sponsoring terrorism than to a group of pupils from let's say Norway on an excursion. Large established airlines have much information in the reservation systems which can also be used for data input for security inspection. If a suspicious passenger or a group of passengers who cannot be assigned to common categories appear on the flight, increased attention can be paid to them. At present there are several databases on the most wanted terrorists in the world.

From the beginning of 2004, as one of the security measures after the September 11, an agreement came into force allowing US Customs and Border Protection (CBP) to access European airline reservation databases to use up to 34 pieces of information about each passenger. However, the deal on the passenger transfer of data was annulled by the European Court of Justice and a new agreement on passenger data on U.S. bound flights was signed in autumn 2006. In the new scheme airlines will 'push' the data to the U.S. counterparts. The data could be divided into five basic categories:

Information about the passenger: name; address; date of birth; passport number; citizenship; sex; country of residence; US visa number (plus date and place issued); address while in the US; telephone numbers; e-mail address; frequent flyer miles flown; address on frequent flyer account; the passenger's history of not showing up for flights.

Information about the booking of the ticket: date of reservation; date of intended travel; date ticket was issued; travel agency; travel agent; billing address; how the ticket was paid for (including the credit card number); the ticket number; which organisation issued the ticket; whether the passenger bought the ticket at the airport just before the flight; whether the passenger has a definite booking or is on a waiting list; pricing information; a locator number on the computer reservation system; history of changes to the booking.

Information about the flight itself: seat number; seat information (e.g. aisle or window); bag tag numbers; one-way or return flight; special requests, such as requests for special meals, for a wheelchair, or help for an unaccompanied minor.

Information about the passenger's itinerary: other flights ticketed separately, or data on accommodation, car rental, rail reservations or tours.

Information about other people: the group the passenger is travelling with; the person who booked the ticket.

However, there are also protected data like information on political orientation, racial or ethnic data, religious or philosophical opinions, trade union membership, and data concerning the health or sex life of the individual [202].

Further security enhancement will be accomplished after full implementation of new EU passports with biometric data.

Security inspection of the registered baggage was introduced as a countermeasure after the sabotage on Pan-Am 747 over Lockerbie in Scotland. The aim of the inspection is discovery of explosive or other banned substance (combustible materials, acids, drugs) in the baggage of the passenger. Performing security inspections of registered baggage means substantial change in the common checking process. The majority of airports with commercial flight operations have automatic systems of baggage screening which usually trace suspicious baggage before the passenger passes the security check and could be retained there to be present during the subsequent manual baggage inspection.

The ultimate requirement is 100% inspection of all registered baggage by technical devices with specified parameters or in combination with manual inspections.

Another requirement of baggage inspection is to ensure baggage reconciliation of the registered baggage with the passengers. It has to be ensured that all passengers that have handed in their luggage during the check-in process have also boarded the appropriate aircraft. There are some exceptions for when flight schedules are disrupted. The system of baggage reconciliation should also ensure a permanent monitoring of the movement of passengers and baggage in the areas of the airport and the information as to which part of the aircraft hold space the baggage was loaded, in case it is necessary to search out and unload the baggage. It also has to be ensured that after inspection there is not a possibility to replace it or to put anything into the baggage.

The system of baggage reconciliation has two principal shortcomings. In fact there are suicide bombers, who try to bring the bomb on board themselves and detonate it, and also there could be

persons that had a bomb planted into their baggage without their knowing it.



Figure 13-4 X-ray black and white image of a baggage

The baggage reconciliation is usually provided by computer comparison of databases of baggage tags with the boarding card of the passenger, which were generated at check-in. The baggage tag can have a record with a bar code which will be gradually replaced by the Radio Frequency Identification (RFID) technology. The problem with the current barcode-based tagging method is that the laser barcode scanners, used to track the movements of baggage, are prone to failure. Some systems use a baggage tag record as well as a boarding card record. The code is at the same time used as information for sorting the baggage. Before boarding the plane or on passing chosen specific locations, the boarding card could be inserted into a reading device and in this way the movement of the passenger can be monitored. However, in some countries there is a legal problem where a system of passenger movement monitoring is considered as an infringement of civil liberties.

In a few years time, the bar code will be replaced by RFID technology. The International Air Transport Association (IATA) introduced a global standard for RFID baggage tags in 2005. According to IATA, the success rate of barcode-based tag reading is just 85 per cent, while an electronic RFID system would increase this read rate to between 95 - 99 per cent. One of the barriers to adoption of RFID technology at airports for airline baggage tagging is the tag price which is at the moment ten times higher than for a printed barcode label [200].

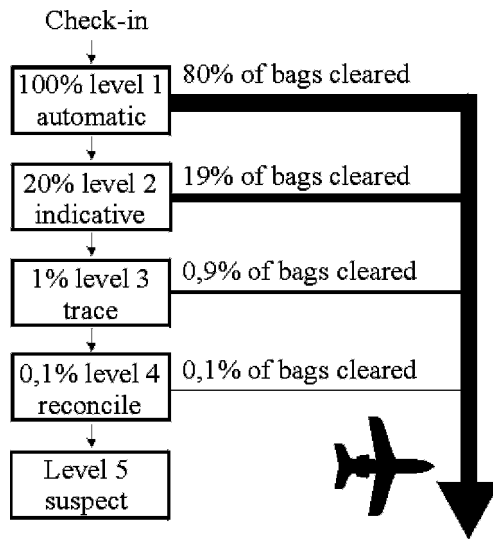

Figure 13-5 Automated 5 stage - 100% hold baggage screening

Baggage inspection can be performed manually or with the use of technical facilities, at present particularly with the use of X-ray units.

Manual inspection of baggage has several advantages over the X-ray inspection e.g. identification of the majority of objects in the baggage is easier compared to the interpreted display on the screen, it has lower initial costs, and thoroughness of inspection depends primarily on the time spent and so it is possible to react promptly to the external conditions (Figure 13-4).

On the other hand, inspection with the use of X-ray units has several advantages over the manual inspection. It is easier for the X-ray unit to discover secret partitions in the baggage or objects hidden inside other things, and it enables higher productivity and hence decreases labour requirements. Also, the passenger's privacy is less disturbed when his or her personal belongings

are being inspected and it is difficult for the potential terrorist to predict how successful he or she can be in hiding the weapon against the X-ray inspection.

Automation of security inspection with the use of technical devices has a number of advantages in comparison with the inspections that are executed personally, by security screeners. The machine is different from humans in that it does not decrease in efficiency and reliability when repeating monotonous activities. The machine also does not make mistakes. On the other hand the technical facilities are only the tools that speed up the security inspection and make it easier. In order to ensure effective inspection the screener must be properly trained and acquainted with the equipment in order to be able to use it effectively.

It is compulsory for all international airports to have 100% hold baggage screening. If automated, the baggage inspection may be designed as a 5 stage process (Figure 13-5). At the beginning of the process there is a computer controlled X-ray unit that automatically sorts out the baggage. The suspicious baggage is identified according to the weight of articles in the baggage, affinity of shapes of the objects with suspicious objects, and the atomic weight of substances. During this test, the 80% of baggage which is not suspicious, is sorted out and can be immediately loaded into the aircraft.

Approximately 20% of baggage which does not pass the automatic inspection is subject to further inspection by X-ray unit such as that supplied by the Vivid company. The X-ray unit marks the possible explosives with a red colour. The security inspection worker will inspect the baggage on the X-ray unit monitor. Suspicious objects in the baggage can be enlarged on the monitor. Sometimes it is difficult to identify plastic explosives because they can be shaped into the form of common objects. It is more difficult to hide timing devices or primers. Therefore the operator looks particularly for devices connected by wires. In this stage of inspection another 19% of baggage is sorted out and sent off to the aircraft.

Each suspicious piece of baggage is subject to a third stage of inspection. In this stage a gas analyser is used, which can, by means of gas chromatography, discover the traces of some explosives. On the basis of this test it is possible to eliminate approximately a further 0.9% of baggage.

The baggage that does not pass the gas test will be subject to manual inspection. In a separate room and in the presence of the passenger, the baggage is opened and properly inspected by an explosives expert. According to Glasgow airport the manual inspection is necessary for only one of 5000 to 7000 pieces of baggage.

A different approach has been chosen by the Israeli airline El-Al, which in addition to technical facilities relies on ascertaining the passenger's profile in a conversation with the security

inspection worker, together with proper manual inspections. In the course of the inspection the passenger is asked questions separately by two workers, the answers being compared and evaluated. Answers are of the same importance as the reactions of the passengers. A precondition of their correct interpretation is high professionalism and experience of the security service workers. However, the circumstances of the El-Al company are unique. Particularly close co-operation of security departments with state administration and their direct link to the information service is necessary. El-Al has relatively few international flights, so it is possible to provide inspections by elite workers at each point. The precondition of this approach is not only extensive support of the state but also top level professional training and high motivation of the workers.

To speed up the security screening process and facilitate movement of frequent passengers, crew members or airport staff, various systems of positive identification using biometric identification patterns were introduced recently at many international airports. Frequent travellers could usually sign up for a programme, have their biometric scan registered and pay a fee. Many airports use this type of service not for arriving, but departing passengers to expedite the check-in and security screening. In most cases iris recognition is increasingly used as a convenient way of positive identification. Passengers do not need to put down their baggage and the recognition is normally accomplished within less than a second.

13.4 DETECTION OF DANGEROUS OBJECTS

As has already been mentioned, inspection with the use of technical equipment has a number of advantages, which make the security inspections easier and speed them up and at the same time limit the possibilities of human factor errors. When selecting the equipment it is particularly necessary to take into account the airport size, number of passengers in the peak hour, passenger and flight profiles, level of income, acquisition and detection costs.

Detection devices for discovering explosives and other inadmissible objects have to meet many criteria. They must be able to discover weapons and explosives, which are used in the military or in the civilian sector. The sensitivity of the device must not be affected by the location of the explosive or the type of container and, moreover, the device has to function with a minimum of subjective human input. The price of the device and its peak capacity are also important. Several devices have been developed, which meet most of these criteria. These include metal detectors, X-ray units, gas analysers, vacuum chambers and use of trained dogs.

Metal Detectors

Modern metal detectors can discover weapons made from ferrous and non-ferrous metals, some

also from composites or metals with low electrical conductivity. The walk through metal detectors are most common and, being relatively cheap devices, are used even at small airports for passengers and employees screening.

X-ray units

X-ray devices were first used at airports in the USA at the beginning of the seventies. They have become an effective device for discovering potential hijackings, which at that time represented the greatest danger. The first X-ray units were not sufficiently sensitive and the display of the baggage on the monitor in real time did not provide enough time for the operators to recognise dangerous articles in the baggage. The picture was not sufficiently clear. In addition to other things the X-ray capabilities were characterised by two, to a certain degree different parameters:

- resolution, indicated by the thinnest steel wire that an X-ray unit is able to display on the light background
- penetration rate, measured as the thickest steel plate that an X-ray unit is able to radiate through without having the plate displayed as a completely black object.

However these criteria are not accepted as a standard worldwide.

X-ray units have to meet health standards concerning radiation leakage. According to the standards valid in the USA, radiation leakage must not exceed 0.5 milli Roengen per hour ($\text{mR}\cdot\text{h}^{-1}$). In modern devices this leakage usually does not exceed $0.1 \text{ mR}\cdot\text{h}^{-1}$. The X-ray system must be safe for photographic film, magnetic carriers of data or data in electronic notebooks.

In 1980 the firm EG&G Astrophysics introduced Linescan System I, the first digital system, which used as sensors a series of silicon diodes, producing black and white images. The system gave a high quality of display and high reliability. Sensitive sensors enabled the radiated output to be decreased so that the device was safe for a photographic film. The device has been further improved, individual objects in the baggage being displayed in pseudo-colours depending on the material's thickness and density. The principle of a modern X-ray unit is shown in Figure 13-6.

In 1988 EG&G Astrophysics introduced the first X-ray unit functioning on the principle of radiation of two different energy outputs (Dual Energy Systems). This type of X-ray unit is known by the abbreviation E-Scan. An X-ray unit with the same technology was developed by the Heimann company and is being offered under the name HIMAT. E-scan is capable of distinguishing organic and inorganic substances by their atomic numbers. Objects with atomic number below 10 are classified as organic and on the monitor they are displayed in orange / brown shades. Explosives and narcotics have these low atomic numbers. Plastics and explosives such as Semtex or C-4, which also have a low atomic number, are displayed by an orange warning colour

on the monitor, which attracts the attention of the operators. Objects with atomic number higher than 10 include metal objects (e.g. weapons). These are displayed in shades of blue. Very thick objects that cannot be penetrated by low energy radiation, are displayed in green. In this way the attention of the well trained operator is drawn to the suspicious objects, the baggage then being manually searched.

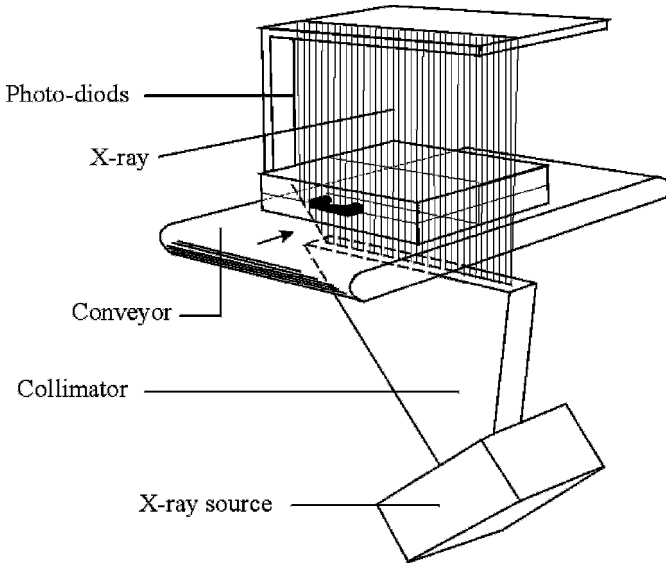

Figure 13-6 Principle of modern X-ray unit

Another type of X-ray unit, which is offered by the Heimann company under the name HI-CAT (Computer-Aided Tracing) uses a computer to search for suspicious objects. Shapes of dangerous objects (guns, knives etc.) have been saved in the computer memory, these being compared with the objects in the baggage. The attention of the operator will be drawn to the object by the computer.

An X-ray unit which gives a three dimensional display of baggage is being offered under the name Z-Scan. The three dimensional display is achieved by associating two emitters in one X-ray unit. The first radiates the baggage from the side and, with a time delay, the second cross-ways from the bottom. The results of both X-ray units are processed by a computer, which assigns a division of weights in vertical sections through the baggage. From individual sections a three dimensional picture of the baggage is generated. By means of an algorithm the location of atomic weight of plastic explosives is identified and the attention of the operator of the device is automatically drawn to them. The inspection of one piece of baggage takes no longer than 5 seconds.

An X-ray unit from the firm Vivid Technologies - USA, uses the technology of the Hologic company's computer tomography, which was originally used in health care, for identification of dangerous objects in the baggage. As in the case of E-Scan, the baggage will be gradually radiated by 70 kV energy and then by 140 kV. The results of both tests are processed. By comparison with the database, the system is automatically able to determine suspicious objects. They will be displayed in red and the attention of the operator will be drawn to them. The advantage of this device is that it can also work fully automatically and suspicious baggage will be sorted out so that the operators can concentrate on the suspicious baggage.

The majority of modern X-ray units have functions that substantially simplify the work of operators and remove the shortcomings of the first X-ray units with imperfect television monitor displays. Digitalised video recording allows the object to be searched for any period of time with further processing of the picture, e.g. enlarging of one part of the baggage. Emphasising the edges of individual objects and wires (Edge Enhancement) makes it easier to discover electronic primers. Identification of objects behind very thick objects (lead plates) is made easier by gamma emphasising (Gamma Enhancement), which makes the picture lighter or darker.

A recent improvement, which was introduced to the market by the firm EG&G Astrophysics in 1994, is replacement of traditional photodiodes by a combination of optical fibres and a CCD camera. In comparison with the photodiodes this technology has low interference and substantial improvement of the picture quality even with a high speed conveyor belt. While with traditional X-ray units the speed of the conveyor belt can be around 0.25 m.s^{-1} , with the new Super E-Scan-200 a high-quality picture is provided with conveyor belt speeds above 1 m.s^{-1} . This substantially increases the capacity of the system of baggage inspection.

Modern X-ray units equipped with a microprocessor are more reliable and require less maintenance. They allow automatic calibration and inspection of the device with identification of faults.

For the inspection of persons before entering areas with special security needs, it is possible to use a soft X-ray unit. The high sensitivity of the device and the system of scanning, which synchronises the movement of the emitter and the scanning device, substantially decreases the level of radiation.

Modern detection units must satisfy specific tests and are classified as Explosive Detection System (EDS), Explosive Device Detection System (EDDS), Primary Explosive Detection System (PEDS), Threat Image Projection (TIP). The equipment can be used only in a strictly specified way and in line with the equipment characteristics and performance. The definition of the equipment is as follows [72]:

Explosive Detection System (EDS)

A system or combination of different technologies which has the ability to detect, and so to indicate by means of an alarm, explosive material contained in baggage, irrespective of the material from which the bag is made.

Explosive Device Detection System (EDDS)

A system or combination of different technologies which has the ability to detect, and so to indicate by means of an alarm, an explosive device by detecting one or more components of such a device contained in baggage, irrespective of the material from which the bag is made.

Primary Explosive Detection System (PEDS)

A system or combination of different technologies which has the ability to detect, and so to indicate by means of an alarm, explosive material contained in baggage, irrespective of the material from which the bag is made. Capabilities of PEDS are lower than those of EDS; their use should be limited in time and operating procedures should be adapted to detection capabilities.

Threat Image Projection (TIP)

A software programme approved by the Appropriate Authority which can be installed on certain X-ray machines. The programme projects virtual images of threat articles (e.g., guns, knives, improvised explosive device) within the X-ray image of a real bag under examination or complete virtual images of bags containing threat articles, and provides immediate feedback to the X-ray machine operators of their ability to detect such images.

There are also other technologies recently tested. In the backscatter systems the waves are reflected back from an obstacle. The TADAR system is based on millimeter-wave gigahertz technology scanners. It is designed for screening of people at airports and other high security sensitive areas. It can detect metal or non-metallic objects under clothing, including the person's body. Even though TADAR can detect hidden weapons, it also raises questions of privacy and whether it should be used on the general public at the airports, as the body shape is visible on the screener's monitor.

Gas Analysers

Terrorists prefer plastic explosives. Some of them, such as Semtex and C-4, are more effective by one third than TNT and this is twice as effective as dynamite. The basic components of all plastic explosives are either RDX (cyclotrimethylenetrinitramin) or PETN (pentaerythritol tetranitrate). Highly explosive substances pass almost immediately into a gaseous state after explosion, the speed of detonation of C-4 being 8 052 m per second.

The plastic explosives were developed during the Second World War because they are more effective but also resistant to the environment, as they can be detonated only by a primer, and also because they can be formed. By precise dosing of additives and shaping, it is possible to give them almost any appearance, from bricks, leather shoes to childrens' toys. Another advantage of plastic explosives, for example Semtex, is that they have practically no smell and their emissions can be identified only with difficulty.

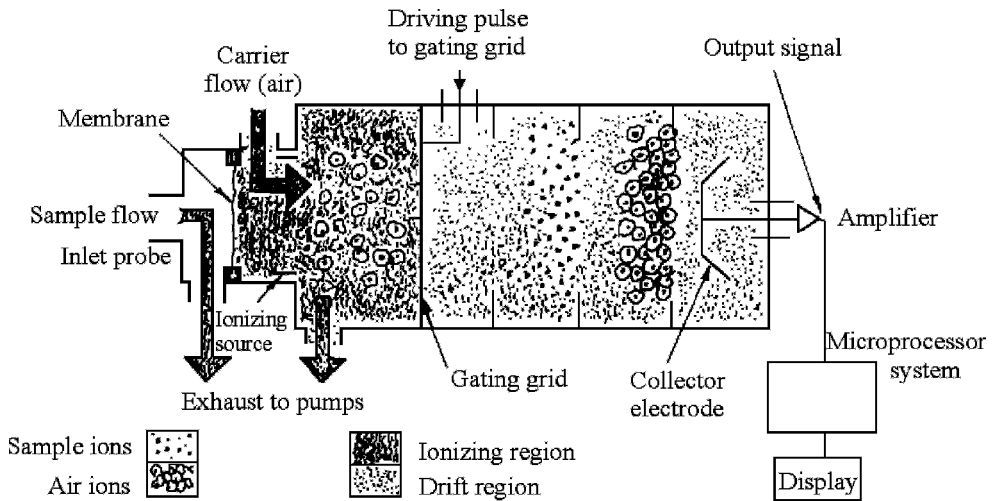

Figure 13-7 Principle of gas analyzer

Therefore the member states ICAO adopted in March 1991 the convention on marking plastic explosives to aid their detection. In the course of production the plastic explosives have to be marked by one of the four agreed substances. These are ethylene glycol dinitrate; 2,3-dimethyl-2,3-dinitro-buthane; para-mono-nitrotoluene or ortho-mono-nitrotoluene. The aim is to increase the level of emissions of material so that they can be more easily identified by common gas analysers and by dogs. Unmarked explosives are limited to use for military and police purposes.

The devices for identification of explosives are used as a supplement to other technical facilities, e.g. to X-ray units or as independent devices. In order to identify explosives on the passengers, the gas analysers can be built into, for example, a revolving door. The device can further be equipped with a magnetic card sensor for inspection of the entry of employees into especially high risk areas (e.g. air traffic control centre). Manual detectors can be used for inspection of baggage.

Some of the detection devices work on the principle of gas chromatography (Figure 13-7). Emissions from the investigated object are sucked by a pump into the first chamber of the detector,

where they will hit the membrane of the silicone rubber. The emissions of the explosives pass through the membrane into another chamber, where they and also the air molecules are exposed to a weak source of radioactive radiation, which ionises them and the molecules acquire an electrical charge. The ionised molecules are then driven through a tube with an electrical field pulsating with the frequency of 50 Hz, after which they hit a scanning electrode, which records them in the form of a weak electrical current.

If the emissions of explosives are really present in the sample that is being investigated, after ionisation they get bigger and heavier than air ions and therefore they move more slowly through the tube. At that time the device records one more, later current impulse. From the position and size of the second current peak, the microprocessor will specify the composition and concentration of emissions of the investigated substance. The relative concentration of emissions is usually shown on the display of the device.

A certified gas analyzer must satisfy requirements on Explosive Trace Detection Equipment (ETDS). According to [72] an ETDS is a system or combination of different technologies which has the ability to collect and analyse particles on, or vapour from, contaminated surfaces or contents of a luggage, and so to indicate by means of an alarm the presence of traces of explosives.

Vacuum Chambers

At some airports the baggage and air cargo are subject to additional inspection in a vacuum chamber. The chamber simulates the low pressure which would be achieved in the aircraft in which the explosive might have been vacuum primed. The possible charge may then be fired in a safe environment. The possibility of exploding any primer by pressure vibrations, ultrasound or by electrical impulses is also being investigated.

Dogs

Using trained dogs is still a very common way of discovering explosives. Dogs are very fast, work effectively and are able to sniff out what most of the devices cannot discover, such as clear plastic explosives and trinitrotoluene. Another advantage of dogs is that they can penetrate places where the human would never get.

The disadvantage of dogs is that they cannot work by themselves and independently. Also, depending on the conditions applying in a particular country, there can be high costs for taking care of them. They must be managed and trained by an experienced dog handler. A dog may lose concentration, lose interest or its attention can be distracted by another object. In spite of that, it carries on performing the trained activity. Another problem is that the smell of the sought object

can be covered, either intentionally or not, by other strong smells e.g. by solvents, ammonia or fuel.

Therefore it is best to use the dogs more as an additional procedure, e.g. for inspection of aircraft, baggage and objects when there is a danger of bomb attack. The dogs are less suitable for regular inspection of baggage.

13.5 SUMMARY

Each airport must have an airport emergency plan, the extent of which corresponds to the airport size and its importance. In addition to other things it must specify not only the duties of security departments but also of individual employees for different kinds of emergency situations. Examples of such situations can be fire, attacks on the airport and its premises (stores, fuel farms, air traffic control, apron etc.), planes or hijacking of planes or landing of a plane with the terrorists on board. The plan has also to identify the emergency staff that will proceed according to the planned procedures.

A higher quality of technical facilities decreases the probability that the saboteurs can get the explosives or weapons on board aircraft by traditional means. However this does not mean that they will give up their activities. On the contrary it is possible to assume that they will look for other ways to achieve their objectives. Therefore it must be ensured that all routes to the aircraft are protected. It is no use installing facilities for detection of explosives for millions of dollars if the security measures are such that it is easy to get to the apron and to the planes without being detected. Equally it is a waste of money if the operating personnel are not sufficiently trained and motivated. In other words high quality technical facilities are welcome, however it must not be forgotten that they can be effective only when fully integrated into a sophisticated security system.

14

LANDSIDE ACCESS

Tony Kazda and Bob Caves

14.1 ACCESS AND THE AIRPORT SYSTEM

The primary advantage of air transport is speed, particularly for long haul where it has completely supplanted shipping, but also for those short haul trips where it is in competition with surface transport. However, the average speed is reduced by the ground portion of the trip. The trip does not start or finish in the airport, but at home, at the hotel, at the workplace etc. The passenger is just as concerned to reduce time on the ground as in the air part of the trip, and just as annoyed by any delay, whether in the air, the terminal or on the way to and from the airport. The total time of transportation 'from door to door' is decisive for the passenger. The attractiveness of an airport markedly decreases if the time of access by surface transport exceeds a certain maximum time. For short haul trips this might be as short as 30 minutes, while two hours or more might be acceptable for long haul, inclusive tour or low cost carrier trips.

Transportation time to the airport is just one of the three most important factors affecting the decision process of the passenger for a particular airport, the other two factors being price of the flight ticket and number of flights (frequencies) offered. The quality of surface transport affects the size of the catchment area of the airport in the competitive market between several airports. Surface transport quality and quantity should not need to become a limiting factor of the development of air transport at an airport if plans have been properly developed. Yet,

paradoxically, it may be the very success of increased access traffic that limits an airport's growth, if the environmental impacts of the ground transport are too severe. The problem remains that in some cases there is no co-ordinated approach to the planning for an airport and that for the town and the region that it serves, particularly with respect to transport. Yet the peaks of traffic to an airport often mirror the peaks in the local traffic. Sometimes the responsibility for planning and operation of the various modes of transport has been divided among several departments.

Table 14-1 Distance of some airports from city centres and connection times by public transport

City	Airport	Distance [km]	Connection times (public transport) [min]
London	Gatwick	43	31
Hong Kong	Chek Lap Kok	40	23
Chicago	O'Hare	35	29
Paris	Roissy	28	35
New York	J.F. Kennedy	27	38
New York	Newark	25	32
London	Heathrow	24	55 (15/*)
Tokyo	Haneda	19	22
New York	La Guardia	13	18
Frankfurt	Rhein Main	10	12
Paris	Orly	10	31

**/ By Heathrow Express*

From the beginnings of air transport the airline companies laid great emphasis on the provision of transportation of the passengers to and from the airport. In the early days of aviation many passengers had no other means of transportation to the airport except the airline coach. The airports have been, contrary to the railway stations, located outside the towns they served. Therefore the airlines found it quite natural to provide transport for airport access, mostly by bus. The first connections of the airport and the town by rail were built in Berlin and London at the end of the thirties.

Table 14-2 Land access modal split at selected airports with rail links

City	Mppa (2005)	Rail time [min]	Rail %	Bus %	Taxi %
Amsterdam	44.2	10	33	4	18
Baltimore	19.7	34	1	14	7
Brussels	16.1	20	13	2	20
Copenhagen	19.9	12	37	4	33
Frankfurt	52.2	10	27	8	19
Hong Kong	40.3	23	24	33	15
London (LGW)	32.8	30	21	9	17
London (LHR)	67.9	16	23/*	12	26
Los Angeles	61.5	45	0	18	13
Madrid	41.9	12	14	7	40
Manchester	22.1	13	6	11	28
Munich	28.6	40	28	7	12
New York (JFK)	41.9	35	2	8	42
Osaka	16.4	29	41	14	5
Paris (CDG)	53.8	29	20	10	37
Paris (ORY)	24.9	34	13	16	27
Rome (FCO)	28.7	36	27	5	32
Seoul (GIM)	13.4	20	30	35	6
Stockholm (ARN)	28.8	20	15	17	16
Sydney	28.3	10	8	18	16
Zurich	17.8	10	42	5	10

*/ Combined Heathrow Express (9%) and Piccadilly metro link (14%)

(Sources: IATA Airport Manual, modified by the authors, airports data)

After the Second World War, as a result of mass development of passenger car travel, there was an increase in the use of the car for transportation to/from the airport, and the need for improvements to the road system to allow convenient access. Now there is an emphasis on increasing the public

transport share of airport access trips, both for the travelling public and for airport employees, in the face of road congestion and environmental concerns. The passenger modal splits to a selection of airports with rail links is given in Table 14-2 [195].

In designing the airport and planning its development, the transportation to and from the airport has to be considered as an integrated system, including transportation by passenger cars, taxis, rental cars, buses, coaches and railway transport, not forgetting also the use of marine transport and helicopters where appropriate.

14.2 SELECTION OF THE ACCESS MODES

A gradual increase in the share of the available high occupancy modes of transportation normally occurs as the airport grows, and this change should be encouraged on the grounds of environmental impact and balanced capacity. Car trips will always predominate at small airports. Growth in the share of high occupancy vehicles as the traffic increases will normally take the form of public (mass) road transportation at moderately sized airports, while high capacity rail transportation should have a substantial share in the large airports. Public transportation should have some role by the time an airport reaches 2 million passengers per year (mppa), including airport workers who do not always have access to a car. Many factors make the car the preferred mode of access for passengers, including the low marginal cost, the convenience for carrying bags and family groups, and the instant availability. It is therefore not easy to get people to move to high occupancy modes even if they are competitively priced, frequent, reliable and form part of a transport network that allows access to the complete catchment area. The airport administration has a new role to ensure that the passenger can get to and from the airport quickly, easily and simply so that they do not miss their flight. If the management does not do this, some potential passengers will be lost to other airports or other modes of transport. Surface transport must be considered as a part of the 'product' of the airport. Managers have to work to fulfil the airport's access needs by encouraging the local authorities and transport operators to respond by investing in roads and operating services.

Theoretically it would be possible to ensure the change in the share of individual modes by making the mass transportation more attractive or by making the private transportation less attractive by imposing road tolls, high parking fees etc. However, individual groups of people accessing the airport, who will mostly be passengers and those accompanying them, employees or visitors to the airport, will all rank the factors differently. The following factors can be identified as affecting the selection of the mode of transport:

→ the availability of the mode

- the distance of the airport from the home or workplace
- duration of the individual elements of the transportation process (waiting, time to access the mode of transport, transportation time, time from the mode to the airport check-in)
- standard of comfort and quality of transport, which includes ease of use, number and quality of seats, handling of baggage, number and difficulty of transfers en route, possibility of secure parking
- reliability of transport
- total generalised cost of transportation (parking fees, value of time etc. must be included as well as fares or marginal cost of using private transport)
- other factors such as personal safety, privacy, flexibility.

Research shows that the decisive factors for passengers are: price, transportation time, number of changes and baggage handling. For airport employees particular concerns are flexibility, availability and personal safety for shift patterns out of normal hours.

14.3 CATEGORIES OF SURFACE TRANSPORT USERS

Airport access is needed not only by the airline passengers but also by other important groups of users. The number of employees who daily commute to the airport represents one quarter to one half of the daily number of airline passengers at medium size and large airports. In addition there are the accompanying persons (meeters and greeters) who in some countries outnumber the passengers, and the visitors to the airport, this latter category amounting to 5 or 10 per cent of the total. The roads and public transport networks also have to cater for the needs of the local non-airport traffic.

It is necessary to emphasise that there are also other factors which distinguish the airline passengers from other groups of surface transport users that have often a decisive effect on the selection of the kind of transport provided, and these can be different in each case. It is, for instance, necessary for business people to have fast reliable transport, leading to the development of the Heathrow Express. Therefore it is necessary to distinguish categories of passengers using surface transport, characterised by the factors such as:

- the reason of the trip to the airport
- type of flight (scheduled – charter, short haul - long distance flight)
- duration of the stay
- social and economic factors (income, age, occupation, size of household, car ownership)

Each category will have different requirements.

14.4 ACCESS AND TERMINAL OPERATIONS

The characteristics of the various categories that determine access requirements also affect the requirements for the terminal. Those who want a fast and reliable access trip also want to move quickly through the terminal with as few surprises and delays as possible. They will perhaps only expect to check in at the departure gate 10 minutes before the flight closes, having been assigned their seat when making the reservation. In contrast, those with no time pressure will accept a relatively slow coach journey to the airport and a long wait in the terminal in exchange for the assurance of not missing their flight. For example the tour operators encourage these passengers to arrive early, and schedule their coaches similarly. It will be particularly important to them if they are travelling on inclusive tour or on discount fares not to miss their flight, since their ticket will not be interchangeable. They may be in the terminal for three hours or more, and will require many more facilities for food and relaxation.

A similar disparity exists between long and short haul passengers. The airline will need the long haul passengers to be checked in early because there are more formalities to be completed and there is more baggage to be checked in. Also, since fewer airports offer long haul flights, the average access time will be greater and the passengers will need more time to organise themselves before flying. The proportion of leisure travel on long haul is high, so a high percentage of the passengers will have discounted non-transferable tickets and will have the same desire not to miss their flight as the inclusive tour passengers. So, depending on the type of passenger, each will have their own punctuality targets for the access trip and will adjust their start time to meet it. If they are inexperienced travellers, they may well experiment with the access trip in order to get some idea of how long it will take and how to navigate along it.

The actual dwell time in the terminal depends on the actual time of the complete access trip, including finding a parking space and transferring to the terminal, and the planned margin of safety together with the reliability of making the trip in a given time. The actual time for a trip will depend on the distance, the mode used and the traffic conditions. For each mode, it is likely to be normally distributed with a variance that is strongly related to the average time. If passengers have a good sense of the variance, they will leave a margin of safety that will get them to check-in at the prescribed time with a given level of confidence, say 99 per cent. Those with longer journey times will then, on average, spend longer in the terminal even though holding the same ticket type for the same flight as passengers with shorter access times.

Similarly, access trips on modes or routes with low reliability will have a high variance. This will tend to be known to passengers, and they will again adjust their behaviour to achieve the target punctuality. Thus passengers on low reliability access modes or routes will again spend longer in the terminal, since they will, on average, have arrived earlier. If passengers do behave in this way, and if they value their time, they will switch to a more reliable mode according to weather conditions and time of day.

In any case, the terminal should be designed in terms of space and facilities to meet their needs. The correct provision of space will depend on how and where the passengers wish to spend the slack time. Shopping has now become an accepted use of slack time, and in some cases is a deliberately planned activity. However, the processing may also be affected by the knock-on effects of access considerations, particularly if the design uses simulation of representative peak aircraft schedules and distributes the passenger behaviour around them.

14.5 ACCESS MODES

14.5.1 Passenger Car

The high standard of living in developed countries means that cars are widely used for transport, and particularly by air passengers who tend to be richer than average. The car may be owned or rented, the latter being used by passengers whose trip started at the other end of the route and whose local trip origin is a workplace or hotel. Passengers prefer cars because of their flexibility and comfort. The additional factor for the business person is the short door-to-door time. The less well off also prefer cars because they are perceived to have the lowest marginal cost. The real marginal cost of transportation by one's own car can be relatively low, but the parking fees can be high. In some cases tour operators or hotels will reimburse the parking fee to the passenger, or they may provide courtesy coach transport from dedicated car parks.

The high share of private car transport causes growing problems to airport administrations. It is necessary to build new parking places and access roads, and to increase the size of the drop-off zones in front of the terminal building. Constructing multi-level car parks in the vicinity of terminal buildings is costly and takes up space that could be better used for commercial purposes. If the parking places are provided in the remote areas of the airport, in most cases it is necessary to provide courtesy transportation to the terminal building for the passengers, which increases the operational costs. On the other hand, revenues from parking places represent an important part of the airport revenues, most particularly in America. At the biggest airports the revenues from parking can be similar to the revenues from landing fees. Most of the airports solve the dilemma of the distance of the car-park from the terminal building by dividing the car parks between short term high price spaces in the vicinity of the terminal and the long term remote car parks with a

lower charge per day. The share of the number of places in the long term and short term car parks depends on the space available at the airport. A rough estimate of 1000 spaces per million passengers per year may be used, but the total and the split between long and short term parking will vary depending on the characteristics of the traffic in terms of short to long haul flights and the business to leisure passenger.



*Figure 14-1 Kerb in front of the departure concourse for passenger drop-off
(Photo: J. Hladký)*

Space in the central part of Heathrow airport in the vicinity of the Terminals 1,2 and 3 is very limited and can only be accessed through a tunnel, and the rate per day in the short term car parks is approximately four times higher than in the long term car parks. There are fourteen different car parks with different prices at Heathrow airport. The older airports with little space for further expansion have the biggest problems with building the access roads.

The second important parameter of airports with a high proportion of passenger cars for access is the length of the kerb in front of the departure concourse (Figure 14-1). Particularly at airports where the majority of passengers is driven there by another person, called ‘kiss and ride’, the length of the kerb in front of the departure concourse can be a critical point at peak times as the

same central terminal area continues to handle the extra traffic by serving more aircraft gates. The rule of thumb for initial design is 100 m of kerb per million passengers per year. Operational measures can be adopted, such as speeding up the unloading of passengers in front of the terminal with the aid of traffic wardens. It is also possible to organise the traffic in front of the terminal building in two or more lanes. However this increases the possibility of accidents or incidents when passengers are crossing the lanes to the terminal. Multi-level short term parking, with direct access to the terminal from the garage, is perhaps the most effective solution, other than providing remote drop off points and transfers by bus or rail.

It is most important for the private car user that clearly visible signs should be positioned on the roads and on the terminal kerb-side areas well in advance of desired destinations. The terminals, airlines and car parks should be colour-coded and easy to see at night. The information should be concise, quickly identifiable and easily understood.

A large percentage of private vehicle access trips is not only likely to lead to congestion; it also has a negative impact on the environment. At most airports the ground trips associated with the airport generate a greater share of air pollution than the aircraft movements. However, at small airports access almost always depends on private transport. These airports' flights consist in the main of short and medium distance routes by regional aircraft providing spoke connections to hub airports or direct regional point to point transportation. The surface transport must support this system by providing highly reliable and quick transport 'from door to door'. In these lower density situations this can only realistically be provided by the private car, so it is not surprising that it represents the major means of access for all segments of users. To support the local community, free parking is sometimes offered at small airports. Mass transportation to small airports is usually not economically feasible.

14.5.2 Taxi

The taxi has similar requirements for the design of the kerbside in front of the terminal as the private car. However, its kerb occupation time and parking requirements are considerably smaller, the latter consisting of a pool for immediate service and a longer term zone where taxis can wait their turn to be called forward. It would be possible to consider the taxi as an almost ideal means of transport for an airline passenger. It is reliable, comfortable, ensures the direct transportation between the trip origin directly to the kerb in front of the terminal building and substantially reduces luggage handling problems. The high cost relative to the private car is partly mitigated by avoiding the need to park, and, relative to public transport by the ability to share the cost among a group of passengers.

Although the airport administration is not directly responsible for the operation of taxis, the bad impression formed from low-quality or poor value taxi service have an impact on the overall image of the airport. Therefore the airport administration should lay down criteria for the acceptable operation of taxis. Important factors are:

- to ensure the number of taxis meets the demand, particularly at night and in the time when the mass transportation is not available
- to ensure the high quality and fair price of services
- to deal with security issues in some countries and to discourage unofficial operators.

Shortage of taxis can occur particularly at smaller airports when two flights are arriving close together.

The problems of shortage of taxis and quality of service are mutually interdependent. This is often solved by awarding licences to serve the airport for a limited period of time. Many airports, like Praha – Ruzyně or Hamburg, issue licences against a fee. Other airport administrations, like Schiphol, issue licences free of charge on the basis of regular evaluation of the quality of service.

A disadvantage of taxis, and also of private cars, is access to the airport in peak times, where the journey may last longer than by coach which may use special priority lanes or by rail transport or underground if available (e.g. Charles de Gaulle).

14.5.3 Minibus

In some countries transportation between the airport and the hotels or other main traffic generators in the town is provided by minibuses. The minibus, or van, may run according to a time table or wait until it has been filled. It is usually cheaper than a taxi. Some hotels provide courtesy minibuses free of charge to and from the airport. Minibuses represent a blend of public and private transport. They offer some of the door-to-door advantages of a taxi and, at the same time, more security, comfort and speed than a scheduled bus service. They have a high daily utilisation, though they often depart with few seats occupied because, in order to be attractive, they have to be frequent. This can result in a large environmental impact per passenger and congestion at the kerb. This is despite the fact that they take only slightly more space at the kerb than a taxi and substantially less than a bus. An additional problem with those minibuses operated by private companies, as opposed to sponsors like hotels, is that competition encourages them to occupy the kerb as long as possible. This needs strict policing.

14.5.4 Bus

Several types of bus service to airports can be distinguished.

Normal scheduled services of the local metropolitan authority are used more by employees than passengers because of their frequent stops and poor provision for luggage. However, in countries where the use of public transport is high, as in the countries of the former eastern block, municipal buses may be more used for airport access by passengers who are locally resident and are familiar with the route structure. Non-residents can find bus systems confusing and may therefore prefer other modes.

Local shuttle coaches dedicated to airport passengers, for example the Washington Flyer, are more costly, more comfortable and faster than the scheduled buses. However, they usually link the airport only with the municipal rail or bus terminals and the major hotels. They work well for visitors, but are less convenient for locally based travellers who are more likely to want to start or finish their trip from their homes in the suburbs. Los Angeles has plans to use busses to serve several park-and-ride facilities, starting with one at the downtown Union Station.

Longer distance scheduled coach services compete with rail, taxi, private car or even air access to hub airports from more distant cities whose own airport does not offer the same range of air services. They overcome the need for the change of mode that is required on most rail systems to complete an airport access trip, but tend to be slow, infrequent and, as with the shuttle coaches, they may suffer from delays due to road congestion. They are mostly run commercially by a private company, but sometimes an airline operates the service primarily for its own passengers and may even check bags through to the trip destination. Some low cost carriers flying from secondary airports use this system of busses to increase their load factors. Coaches for passengers on inclusive tour holidays, particularly those using charter flights, are organised by the tour operators. Some operators provide a pick-up service at the beginning of the holiday, but the main use is to convey passengers from the holiday airport to their accommodation. They are usually organised into a hub and spoke operation, where a series of flights arrives close together, and the passengers are assigned to whichever one of a bank of waiting coaches is to call at the required hotel. The coach parks for this type of operation at the major holiday airports like that at Palma in Majorca have spaces for hundreds of coaches. The theoretical efficiency of this process is often not achieved because of flight delays.

Another example of interconnection of air and bus transport is the system created by National Express Group plc. They owned East Midlands airport in Great Britain (until it was bought by the Manchester Airport Group) and also the National Express interurban coach company. The airport has no direct connection to rail transport, so a network of coach services has been created with

good and reliable connections, which is an important marketing tool in the competition with the nearby airport in Birmingham.

Both the National Express and the tour operators' models for interlinking air and coach services are examples of private initiatives in line with policies in the US and Europe to provide 'joined-up', or 'integrated' public transport and thus create a more sustainable transport system.

14.5.5 Railway Transport

The recent political push for a sustainable transport system, combined with road congestion and frequent delays, has caused a renaissance of public transport in accessing airports. Many airports are supporting increased use of rail transportation, both to serve the nearest cities and also to increase their catchment, to the extent that airport expansion has been made conditional on achieving targets of up to 50 per cent of passengers using public transport. The UK requires airports to compile access plans which will increase the public transport share. Good examples of the various rail access options already exist, e.g.:

- metros at Madrid, Stuttgart
- high speed networks at Frankfurt, Charles de Gaulle, Copenhagen
- light rail at Baltimore/Washington, Bremen
- high speed dedicated at Heathrow, Oslo, Stockholm, Hong Kong, Kuala Lumpur.

It has to be emphasised that rail transportation is fundamentally a high density mode. Its most effective use is to cater for high levels of traffic. Theoretically, rail transport allows a good connection to all parts of the catchment area and can substitute for other kinds of transport (Figure 14-2). The decisive factors are the extent of the network, and the feasibility and reliability of the connections. Dedicated rail access, of which there are some 14 examples worldwide, usually connects the airport only with the town centre, which is convenient for visitors to the city. However, if the airport is used mainly for originating journeys, most of the passengers tend to start their trip from home and tend to have a car available. They tend either to drive to the airport or are dropped off.

The rail access share depends also on the location of the station at the airport. It should be located either directly in or under the terminal building or it should have an easy connection to it, preferably a dedicated one rather than an urban bus that is exposed to the difficulties of the local road network. If a link is necessary, it adds another mode change to the trip. On the rail part of the airport access journey, the need to make one interchange, as at New York JFK, can reduce demand to only 40% of the direct demand, a second interchange reducing it still further to 30% (Lythgoe

and Wordman, 2002). If a spur can be built to a nearby main line, as has been done very effectively at Amsterdam Schiphol, Köln-Bonn, Geneva and Zürich, it may be possible to avoid an interchange and also expand the catchment area of the airport.



Figure 14-2 *High speed rail connection can increase the airport catchment area*
(Photo: Z. Kazdová)

The decision to connect the town and the airport by rail transport depends on several factors, particularly:

- volume of airport passengers per a year
- possibilities of connection to the existing transport infrastructure

but also:

- split of traffic between scheduled, charter, business and leisure passengers.

There are several options for providing the link that should be compared. Building a special line is, depending on its length, economically justified only for large airports with a minimum of 7 million passengers a year (mppa) for a spur line and normally more than 10 mppa for a dedicated link. Provision of a rail link is now often a necessary condition of further growth of airports of this size. Most of the tracks have originally not been designed for connection to the airport and

therefore the plans to do so are often compromised by the sunk investment and existing land uses. Conventional heavy railway systems are typically characterised by higher speed, lower frequencies and longer distances between the stations. Rail transport has been available at Gatwick airport ever since it opened and its high proportion of total surface transport, at present around 26%, results from the convenient and fast connection to London and the underground network, to other parts of the rail network and also to the availability of check-in at the city rail terminus at Victoria station. Munich airport has been connected by means of two rapid transit links. The airport administration has set an ambitious target of achieving a 40% proportion of rail from the total surface transport. They expect to succeed, as the rapid transit link is connected with the railway transport network and there are plans for a 10 minute maglev connection to the city (the current links take 40 minutes). Frankfurt airport uses rail for cargo access, driven by the ban on lorries in Germany at the weekends. There is the treat of a similar ban, but only for older lorries that cannot meet the EU emission standards, in the London area.

The underground or metro systems are characterised by short distances between frequent stops. The underground is mostly suitable for the employees and for people with business at the airport. Its advantages are high frequency and low cost. The disadvantages are that it is relatively slow and not suitable for the transportation of larger pieces of baggage. For instance the journey by underground from the centre of London on the Piccadilly Line to Heathrow takes 50 minutes on average and has 18 stops. The special heavy rail Heathrow Express, built at a cost of £750 million by the airport, connects the airport with the Paddington railway station. The journey to Terminals 1,2 and 3 in the central area of the airport takes 16 minutes and four minutes longer to Terminal 4.

The Oslo Airport Express Train connecting the centre of the capital with the Gardemoen airport has gained a very high market share. According to a survey of 40 000 passengers in 2005, 35.5 per cent of them used a train to Oslo airport [208]: after two months of service, it had already achieved a 31% share. One reason for this is the high proportion of passengers who originate from the city. Where the market is more geographically diverse, it is more difficult to capture a good share of the market.

The first rail link to Gatwick opened in 1959. The express service started in 1984. Gatwick Express charges £25 return between Gatwick and Victoria and takes 30 minutes. Southern Rail's stopping service costs £16 return and takes 40-50 minutes. In January 2006, Gatwick Express was rated Britain's top train company by the government-funded National Passenger Survey, with 93 per cent of passengers saying they were satisfied. The number of Gatwick Express passengers has increased by 30 per cent since 1995 but its share fell recently to 24 per cent of air passengers arriving at Gatwick by rail in 2003. The number of Gatwick Express passengers fell because the rise of budget airlines at the Gatwick airport was attracting more 'price-sensitive passengers' who preferred to catch the slower Southern services to Gatwick because they were much cheaper [233].



Figure 14-3 *High speed railway station situated at the airport*
(Courtesy: Lyon-Satolas Airport, photo M. Renzi)

The dedicated rail links are often thought to need seamless check-in downtown to make them attractive, and this is available at Zurich, Hong Kong and Madrid. However, BAA closed the check-in facility at Paddington station in the aftermath of the 2001 security problem on the grounds of cost. Also, the chance of lost bags doubles with downtown check-in. Another question is the relation between air transport and long distance high speed railway transport. Some airport administrations consider rail to be an important competitor to air transport on short and medium distance routes. The construction of high speed lines and an increase of the quality of railway transport should, according to the opinion of this group, support this view. (Figure 14-3). New strengthened security measures and resulting delays at the airports can motivate more passengers to use high speed rail on medium distances routes instead of air transport.

However, the frequency of the Paris-Lyon air services was increased recently from 11 to 14 daily, even though the train time is one hour 54 minutes. Also, there are 56 daily air services on the 350 mile Tokyo-Osaka route, in parallel with the frequent ultra fast Hikari services.

Progress towards rail links has been slow in North America because of the car culture and the environmental impacts that would be incurred by building new lines through populated areas. Atlanta has the MARTA system to Hartsfield-Jackson airport, New York JFK links into the metro and heavy rail networks via its Air Train system and San Francisco has a BART link to Oakland airport via a shuttle bus and the BART system is being extended to San Francisco International airport. However, several airports have plans for rail access, driven by legislation to reduce emissions and by road congestion, including Chicago, Denver and Toronto.

Others look on rail more as being an important partner of the airports, which allows a substantial reduction in the time of transportation to the airport and this increasing the catchment area. The stops of the high speed railway cannot be designed so closely as with conventional rail so they can operate only in areas with high population density. Stations for them will therefore be built only in the largest airports. At the same time these airports have the biggest problems with the number of runway slots available, particularly in the peak periods. In these cases high speed rail can really replace some regional flights and the capacity released can be used for long distance flights. But even large airports will have to contribute to the investment in the high speed railway, while it needs a convenient location close to the line of the rail track to make a direct connection to a smaller airport economically feasible. These smaller airports can be connected to the conventional network of fast trains. Those medium size airports with hub operations might absorb the regional flights displaced from the largest hubs but at the moment this does not really happen. From some smaller airports in Great Britain it is more advantageous to fly to New York through Amsterdam than through Heathrow. In some cases the airports themselves will be affected. After the Euro-tunnel opened under the English Channel, it became easier to access Brussels airport by rail from some parts of south-eastern England than London - Heathrow.

Relative to rail, air transport has the advantage of flexibility, which is important particularly for small airports and small airlines. Changing routes and frequencies is much easier for air transport than for railways. However, it is difficult to justify the use of scarce runway slots at congested airports for these very short haul routes.

A relatively new idea is to combine air and rail services. In some cases there are contracts or alliances with cross-investment, as between airlines. There is a long-standing co-operation between Swiss and Swiss Railways. In 1982, Lufthansa and Deutsche Bundesbahn initiated the Lufthansa Airport Express between Frankfurt and Düsseldorf airports with stops in Bonn and Cologne. This service has now been withdrawn since 1990 another line was opened between

Frankfurt airport and the main station in Stuttgart. The Lufthansa passengers can make a seat assignment and check-in baggage in selected railway stations. The service is free of charge and the passengers can be checked in not sooner than 24 hours and not later than 20 minutes before the departure of the appropriate inter-city service. These passengers can use the special 'Rail and Fly' rate. However, Lufthansa has found it necessary to restore 6 air services per day on the route to retain the connecting traffic. Other examples of code-sharing are Amsterdam – Antwerp, Paris – Brussels, Newark – Philadelphia and Paris to about a dozen domestic destinations in France.

It is obvious that a direct rail connection substantially increases the airport's attraction and, in the near future, airports will be judged on whether they have such connection or not. Those without a station directly on the airport will risk being relegated to a minor role in the system.

14.5.6 Unconventional Means of Transport

Unconventional means of transport for transportation between the town and the airport may include different types of elevated railway systems, monorail systems, magnetic levitation (maglev) trains, air-cushion vehicles, and helicopters etc. Hundreds of schemes were proposed in the 1970s, but very few have been implemented. The main reasons are the high costs of building the infrastructure and for the operation of the facility, the slow development of the technology and the need for planning approval in the face of objections to the land use and visual intrusion. Another problem is that most of these systems are not fully integrated in the surface transport net which usually means an increase of the total transportation. However, there are a few examples of successful unconventional lines connecting airports with other transport modes stations.

Perhaps the best known is the Tokyo Monorail which connects Tokyo Haneda International Airport and Hamamatsucho Station in the town centre. The line was opened in 1964 to cope with the increased traffic during the 1964 Summer Olympics Games. The elevated line is 17,8 km long and it takes 22 minutes to reach the airport from the town centre. Currently, the line serves nine stations and handles about 300,000 passengers every weekday. It is often cited as the busiest and most profitable monorail line in the world [234].

Approximately 2.5 million travellers are transported by the Orlyval shuttle every year between the Paris - Orly airport and RER station Antony on line B. The Orlyval was opened in October 1991 (Figure 14-4). The fully automatic line is unfortunately not integrated into the railway network.



Figure 14-4 *Orlyval transportation system (Photo: M. Filo)*

The fastest railway is the Transrapid system operating since November 2003 between the Pudong Shanghai International Airport and the Shanghai Lujiazui financial district (China). The ‘train’ covers 30 kilometres in less than 10 minutes reaching in regular service a speed of 432 km/h during a journey time of 6 or 7 minutes. Maglev trains require special rail track where carriages are levitated, guided and propelled by electromagnetic forces. The construction of the infrastructure is very expensive.

Helicopters avoid most of the planning problems but generate too much noise at the city centre heliports and under the routes, and it is difficult to find slots in the air traffic at the airport unless special non-conflicting routes can be developed. The routes tend to be at low level, so there is noise nuisance under the flight path and people living there feel that they are being spied upon on their own property. Similar objections caused the closure of the Heathrow/Gatwick transfer link.

15

VISUAL AIDS FOR NAVIGATION

Tony Kazda and Bob Caves

15.1 MARKINGS

15.1.1 Markings Requirements

In the beginning of aviation, flights were performed only under Visual Meteorological Conditions (VMC). At low speeds, the natural view of the terrain provided the pilot of an aeroplane with sufficient information for approach and landing under good visibility. As speeds increased, it was necessary to enhance the natural perception of the aerodrome by markings, and to provide the pilot of an aeroplane with additional information by marking the runway and other movement areas and to standardise the markings.

The terrain picture is enhanced by picture texture with objects, trees and other details. The picture texture is important particularly in the last phase of the final approach, during the actual landing and during take-off, when the pilot's attention is concentrated into a narrow visual angle in the direction of the runway and most of the texture is acquired by peripheral vision.

In the initial and middle approach phases and during a circuit, when the aeroplane is further from the aerodrome, the picture structure is important from the viewpoint of providing visual information. It is formed by the horizon and by natural features such as hills, valleys, rivers, fields, and the like. The pilot of an aeroplane may determine the aerodrome position from the picture structure.

Simple marking of ground movement areas is sufficient for conditions of impaired visibility by day, and in good meteorological conditions by night. Similarly, it is convenient to make use of the markings also for providing the pilot of an aeroplane with additional information during approach and landing, such as runway width and length. Natural properties of a picture seen by day in good visibility are complemented with these markings to emphasise the crucial visual information on the location of the aerodrome and its runways. Only in extraordinary cases, when the aerodrome is located in a featureless landscape like desert, is it necessary to supplement the picture structure and texture more than this.

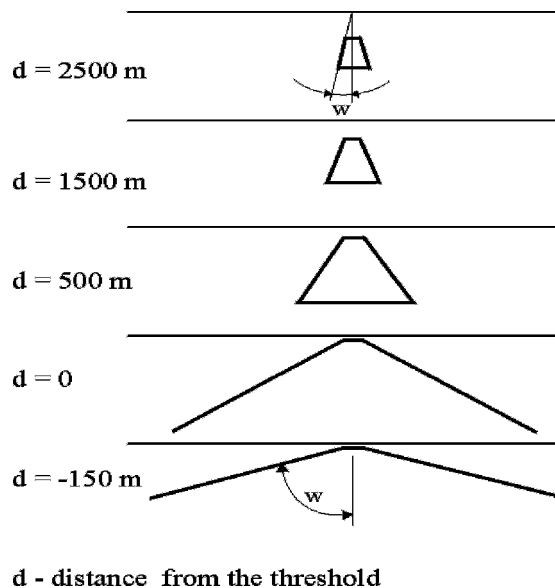

Figure 15-1 *Change of perspective angle on approach with descent angle $2^{\circ}30'$*
 (Source: J. Čihař, *Letiště a jejich zařízení I*, Alfa Bratislava 1973)

The requirements for visual information during a take-off are limited to emphasising the aircraft's position relative to the centre line and the start-of-roll end of the runway, and the ability to determine the speed and location of the aircraft relative to the take-off end of the runway during the take-off run, the rejection of a takeoff and after landing. During the final phase of an approach, the most important requirement is to be able to assess the runway width and length, and the runway length remaining after crossing the threshold.

Directional guidance on the apron and on the taxiway system is given to the aeroplane to ensure that it stays on the taxiway and that it remains at a suitable distance from obstacles. The

information necessary to facilitate the pilot’s orientation at taxiways and on the apron is again emphasised with markings.

The runway perspective, as indicated by the converging angle of its edges. Is particularly important in the final approach phase. The magnitude of the perspective angle is expressed by the relation (Figure 15-1):

$$\text{tg } \omega = \frac{d}{h}$$

where:

- d runway half-width
- h pilot’s eye level above the runway.

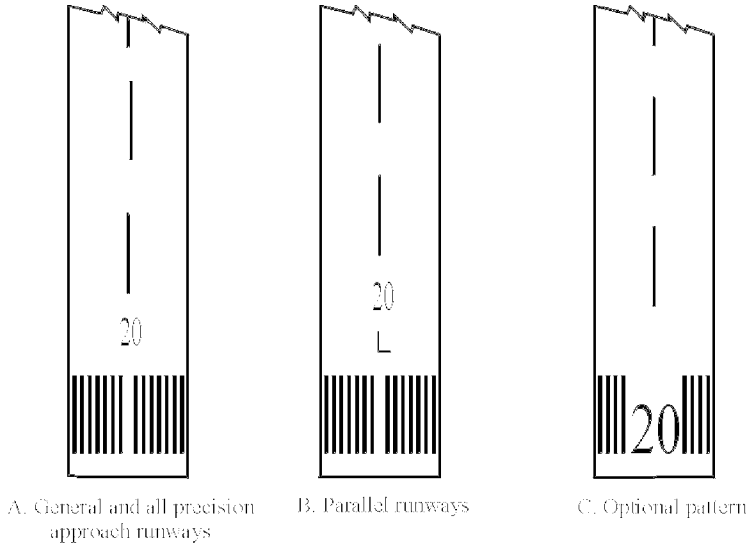

Figure 15-2a Runway design, centre line and threshold markings
 (Source: Annex 14, Aerodromes, Volume I, Aerodrome Design and Operations)

During an approach, the perspective angle increases, and the pilot loses accurate information about the runway direction. Therefore on wider runways, it is necessary to mark not only the runway centre line, but to enhance also the runway edges by marking in order to improve the directional guidance of the aeroplane.

The area of the runway system markings exceeds several thousands and even tens of thousands of square metres. The choice of a material for markings should aim to minimise the total costs. The specifications of coating compositions for aerodrome markings differ from those of coating

compositions for road markings. Especially at aerodromes with moderate traffic, or side-strip markings, the coating will be more affected by meteorological effects or the accumulation of dirt than by mechanical wearing. The paint for taxiway and apron markings should be colourfast. There are several types of paints developed especially for aerodrome markings. The durability of cheaper paints, based usually on oil (alkyd) or water based emulsions, is approximately 3 years, depending on the airport traffic volume. Spraying machines may be used for these types of markings. A drying time of 30 minutes is usually acceptable for airport operation requirements.

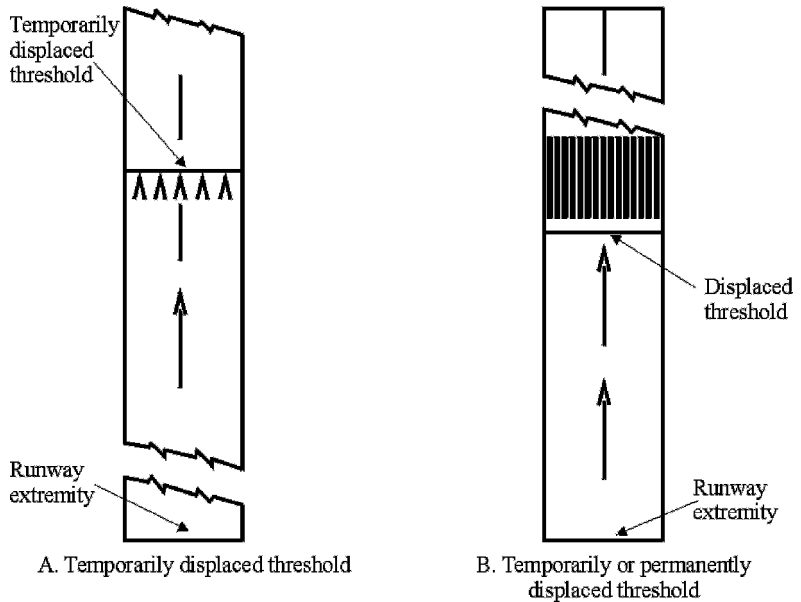

Figure 15-2b *Displaced threshold markings*

(Source: *Annex 14, Aerodromes, Volume I, Aerodrome Design and Operations*)

Two-component paints are usually more expensive. They have a durability of 10 to 20 years, but, in general, it is more difficult to mechanise the marking. It is also necessary to consider that marking in a runway touchdown zone at aerodromes with a high traffic density will quickly become coated with rubber, and therefore it is not efficient to apply more expensive materials with longer durability.

The basic requirements for the markings are the colour, opaqueness, reflectance and roughness of the paint surface. The paint colours are determined by Annex 14, Aerodromes, Volume I, Aerodrome Design and Operations, Appendix 1 in the specified range of the colour spectrum. The reflectance of the marking surface may be improved by adding retro-reflective beads (glass spheres) into the paint. Glass spheres with refractive index of 1.9 or greater with size gradation between 0.4 and 1.3 mm diameter have been found to give the best results for aerodrome marking.

The runway surface markings should not show any significantly different braking effect than that of the remaining runway surface.

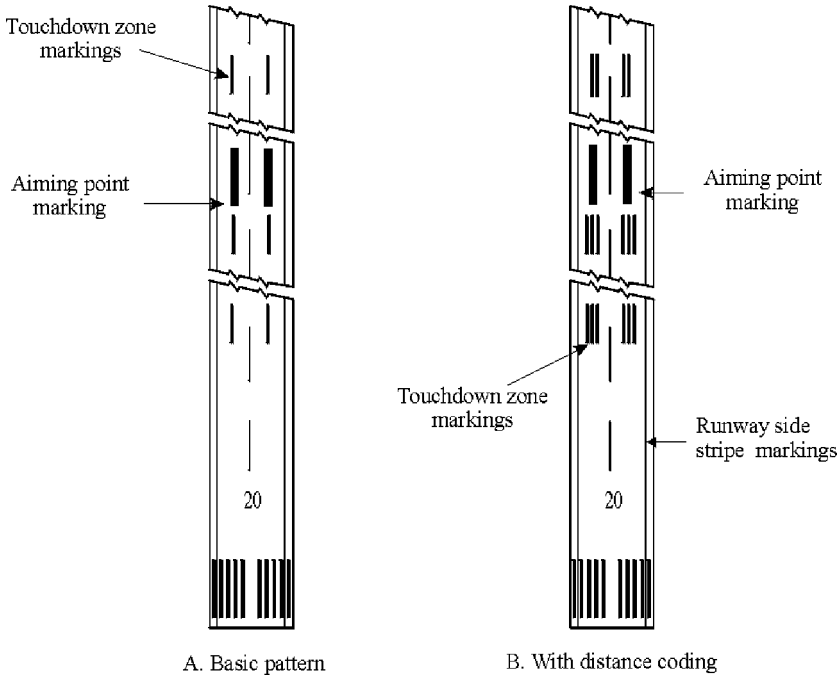

Figure 15-3 Aiming point and touchdown zone markings

(Source: Annex 14, Aerodromes, Volume I, Aerodrome Design and Operations)

If the antiskid characteristics are not sufficient, aluminium oxide and angular glass in sizes which will pass through a 150 micrometer sieve and less than 5% will be retained by sieves with 45 micrometer mesh were found to be effective[176]. Adding the reflective component into the paint also improves the roughness of the marking surface.

15.1.2 Marking Types

The requirements for the physical characteristics of particular markings are given in Annex 14, Volume I, Chapter 5. The extent of the runway markings depends on the runway type and reference code. They apply to the following markings:

Runway markings (Figures 15-2a, 15-2b, 15-3):

- runway designation markings

- runway centre line markings
- threshold markings
- aiming point markings
- touch down zone markings
- runway edge markings.

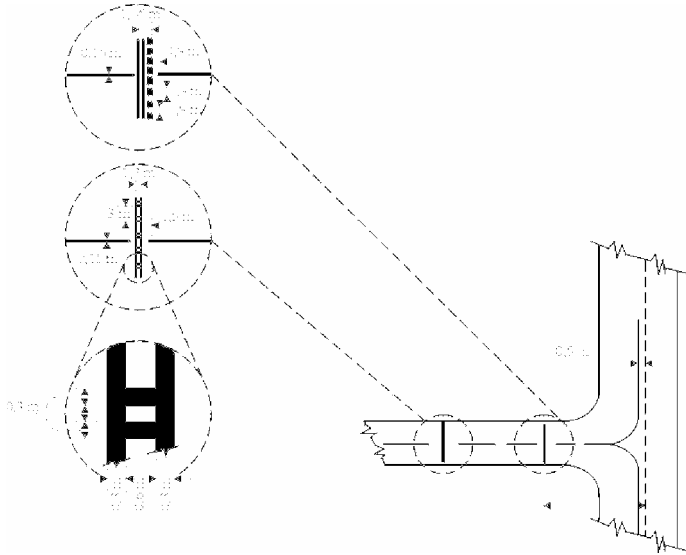

Figure 15-4 Taxiway and taxi-holding position marking – examples
(Source: Annex 14, *Aerodromes, Volume I, Aerodrome Design and Operations*)

Taxiway markings (Figure 15-4):

- taxiway centre line markings
- taxi-holding position markings
- taxiway intersection markings.

Apron markings:

- aircraft stand marking
- stand identification
- lead-in line
- turn bar

- alignment bar
- stop line
- lead out line
- apron safety lines.

Other markings: → aerodrome VOR check-point marking.

15.1.3 Signs

Signs are installed at the airport to assist pilots' orientation on airport movement areas, to give them instructions and information. There are two basic types of signs: mandatory instruction and information signs (Figure 15-5).



Figure 15-5 Information sign (left) and mandatory instruction sign (right)
(Photo: Courtesy of Bratislava M.R. Štefánik Airport)

Mandatory instruction signs specify the point or location beyond which any airplane or vehicle is not allowed to proceed without control tower clearance. These signs include runway designation signs, holding point signs for Category I, II or III and NO ENTRY signs. Mandatory signs always

have white letters on a red surface. The characteristics are given in Annex 14, Aerodromes, Volume I, Aerodrome Design and Operations, Chapter 5 and in the FAA AC 150/5345-44F.

Information signs are used to specify location, direction or destination. They provide information on runway exits, directions to taxiways, aprons, stands etc. Information traffic guidance signs have black letters on a yellow surface. Location signs have yellow letters on a black surface.

Signs are usually constructed from lightweight metals or from light UV-resistant plastics. Plastic materials have better characteristics for reducing radar signal reflections, are practically maintenance free (except cleaning and changing of the light tubes) and have a long operational life-time. For night or low visibility operations all signs must be illuminated externally or internally - usually by 2 or 3 (depending on the size) horizontal fluorescent tubes which are placed inside to ensure an even distribution of light. The panels are mounted on columns with breakable couplings to satisfy frangibility requirements.

15.2 AIRPORT LIGHTS *(Author: František Bělohradský, Consultant, Prague, CZ)*

15.2.1 Characteristics and Components of Airport Lighting Systems

15.2.1.1 Introduction

When looking at a lighted runway from an airplane cockpit during night approach, one can believe that there have been no changes in the airport lighting systems during the last fifty years. In fact the light colours are certainly the same and there were only a few modifications in the light's layout. The most important changes are not visible. In the new systems the latest technologies and materials are used to achieve high economic effectiveness, safety and reliability of the modern lighting systems.

An important, and for the time being irreplaceable role, is played by the aerodrome lighting systems, in addition to the markings and the radio-navigation and radio-location aids. They were all made more important by increases in approach speed, and the need to improve safety. In addition, the need for better reliability called for a reduction of meteorological limits to operation. Under conditions of impaired visibility during the day and at night, the last phase of approach and landing has to be performed with a visual reference according to information created by a picture of lighting systems that augment the purely passive markings. As with other equipment, the aerodrome lighting systems are also standardised internationally by ICAO. The standards arose from the experience of Great Britain in particular, and later from the conclusions of work of the Visual Aids Panel (VAP) and All Weather Operation Panel (AWOP) teams.

The requirements for providing aerodromes with lighting systems vary with the type of runway equipment and reference code. The requirements are different for non-precision approach runways and for precision approach runways. Runways suitable for precision approaches are divided into three categories. Each category has a different meteorological limit for landing and take-off, and the requirements for lighting systems are also different. The ICAO categories are given in Table 15-1.

Table 15-1 ICAO precision approach categories

Parameter	Category				
	I	II	III A	III B	III C
Decision height	60 m (200 ft)	30 m (100 ft)	N	N	N
Visibility/RVR	800/550 m	- /350 m	- /200 m	- /50 m	N

Note 1: N – not defined

Note 2: More information about the precision approach categories are in Chapter 3.

15.2.1.2 Light Sources

The first generation of light sources were paraffin flares. These were supplanted by classical lamps designed for a maximum current value of 6.6 A with a bayonet cap. They are still used at many aerodromes for taxiway edge lights and to illuminate signs. They are made in a power input range of 30, 45, 65, 100, 200 and 300 W. Disadvantages are their large size and relatively small light flux.

First generation halogen lamps, of the so called double cap type, brought about a considerable reduction of the outer dimensions of lamps and an increase of light flux. Up to now they have been used in older types of inset lights. It was often necessary to refocus the lamp filament against the reflector, and the lamps have a relatively short service life because they were extremely heat stressed in the inset light fittings.

The second generation of lights, particularly the elevated ones, use halogen lamps with an exact position of the filament. They have extremely small outer dimensions, high light flux and a long service life of up to several thousand hours. They are made in an output range of 30, 45, 65, 100, 150 and 200 W.

Halogen lamps with an in-built miniature reflector in a single integrated unit are the most recent light sources to be applied in inset lights. These make it possible to design highly effective optical

systems, and reduce the required input of the lights. The light sources made at present have inputs of 40, 45 and 100 W. They are outstanding for their long service life of up to 1 500 hours at 6.6 A., equivalent in normal use of up to 8 000 hours of service before failure.

The new generation of light sources improves the operating reliability of the inset lights, and at the same time reduces the costs of electrical energy and maintenance of the lighting systems.

For low and medium intensity lights, LED sources are now being used extensively. The main advantages of the LED lights are their high luminous flux, low energy consumption and extremely long operational life. Typically the LED sources are used in the taxiway edge lights and low and middle intensity obstacle lights. ADB – Siemens have introduced taxiway inset lights designed for Category III operations.

15.2.1.3 Lights and Fittings

According to Annex 14, Volume I, Chapter 5 the aeronautical ground light is defined as:

Aeronautical ground light: any light specially provided as an aid to air navigation, other than a light displayed on an aircraft.’

The ground lights may be classified according to the following criteria:

- place of installation
- type of mounting
- radiation characteristics
- character of the light.

By where they are located in the aerodrome lighting system, the lights may be divided into:

- obstacle lights
- approach lights
- visual approach slope lights
- threshold lights
- runway centre line lights
- runway touch-down zone lights
- runway edge lights
- runway end lights

- taxiway edge lights
- taxiway centre lights
- STOP-bar lights
- safety lighting bars or ‘wig-wags’
- lighting of information boards.

The types of mounting are:

- elevated
- inset.

The elevated lights are supported above ground level. The inset lights are firmly set in the pavement. Their cap protrudes only a few millimetres above the surface, and can bear the forces created when the wheels of an aeroplane or a ground vehicle roll over them. The optical system of the light is fixed in the cap.

The radiation characteristic of the lights may be divided into:

- reflector: inset lights may be unidirectional lights or bi-directional lights.
- omnidirectional lights, which produce the light into all angles of the azimuth.

The radiation characteristic of the lights may be:

- symmetrical
- asymmetrical
- semi-asymmetrical.

The character of the lights may be classified as:

- constant light
- flashing
- flickering.

Using these characteristics, it is possible to create names for the lights and thus specify them further, for example:

- elevated reflector approach light
- unidirectional inset runway centre line light
- elevated omnidirectional taxiway edge light

- bi-directional inset taxiway centre line light.

15.2.1.4 Frangible safety masts

The approach light system must all lie in one plane which must be horizontal laterally and not be depressed longitudinally more than 1:66 below the horizontal plane for the first 300 m from the end of the runway strip and 1:40 thereafter. It is therefore necessary to mount the lights on posts or masts when the ground is significantly below the runway elevation. Since 2005, the supports must be frangible; i.e. they must be of light weight and designed to break, distort or yield in the event of a collision. Supports less than 12 m should be frangible from the base and those greater than 12 m need only be frangible above 12 m. The challenge for the designer is to provide this frangibility while retaining sufficient stiffness and strength in the design-case winds. While simple steel or aluminium posts can be used for short supports, it is more efficient to use glass fibre for taller supports: tubes for single light fittings or lattice masts if an array of lights is to be supported. Glass fibre is corrosion-resistant and almost maintenance-free. It is, though necessary to arrange for easy maintenance of the lights, usually by articulating the taller masts or using a pivoting base for shorter ones, unless access can be easily arranged by using a cherry-picker (an elevating platform which is adjustable for height and direction).

15.2.1.5 Requirements for Aerodrome Lights

The requirements for lights, their luminosity characteristics, mechanical properties and construction are determined not only by Annex 14, Aerodromes, Volume I, Aerodrome Design and Operations and other ICAO documents, but also by national standards. The requirements for lights may be divided into:

- lighting
- mechanical fitting
- electrical
- other requirements.

The lighting requirements are determined by Annex 14, Aerodromes, Volume I, Aerodrome Design and Operations, Appendix 2 by isocandela curves (Figure 15-6). Isocandela curves for the lights designed for Category I operations are wider horizontally. In contrast, the requirements for light intensity are higher vertically and lower horizontally for Category II. That requirement is even more conspicuous with the lights designed for Category III. All the manufacturers of lighting

systems make efforts to provide lights that comply with the requirements for installation into systems for any of the Categories I to III.

Two basic factors are specified for evaluating the luminosity characteristics of the lights:

- mean light intensity, which is the integral of light intensity in a space beam (Istr)
- evenness of distribution of the light intensity: in a defined beam a minimum light intensity should be 0.5 Istr and a maximum light intensity of 1.5 Istr.

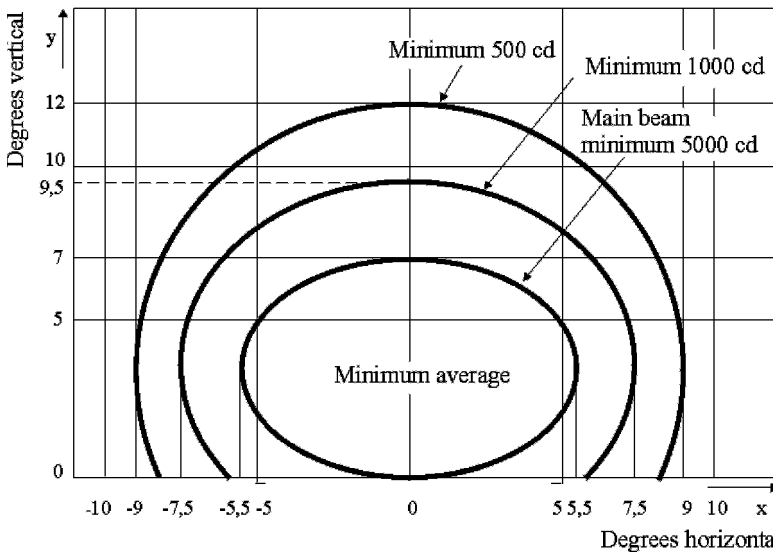

Figure 15-6 Isocandela diagram for runway edge light where runway width is 45 m (white light)

The requirements for the Thorn company’s EL-AT threshold lights and their compliance are shown in Figure 15-7.

The mechanical fitting requirements are separately specified for elevated and for inset lights. The elevated lights should be light-weight, and easily frangible in the event of being hit by an aeroplane or a vehicle. The resistance to wind and jet blast is shown in the Table 15-2.

The frangibility is defined as a property of an object to maintain its structure and resistance until a specified maximum force. If that force is exceeded, the mounting should deform or break in such a way as to create a minimum hazard for the aeroplane.

Table 15-2 The resistance of elevated lights to wind and jet blast

Light	Wind/jet blast speed [m.s ⁻¹]
Approach	51
Visual approach slope	51
Threshold	103
Runway edge	155
Taxiway edge	103

In approach systems, if required due to descending terrain, the so called safety masts are used. They are light-weight, usually lattice structures or towers made of aluminium or laminate, which will be frangible if hit by an aeroplane. At some airports, though the masts themselves are frangible, they are still mounted in substantial concrete plinths which can cause serious damage to an aeroplane.

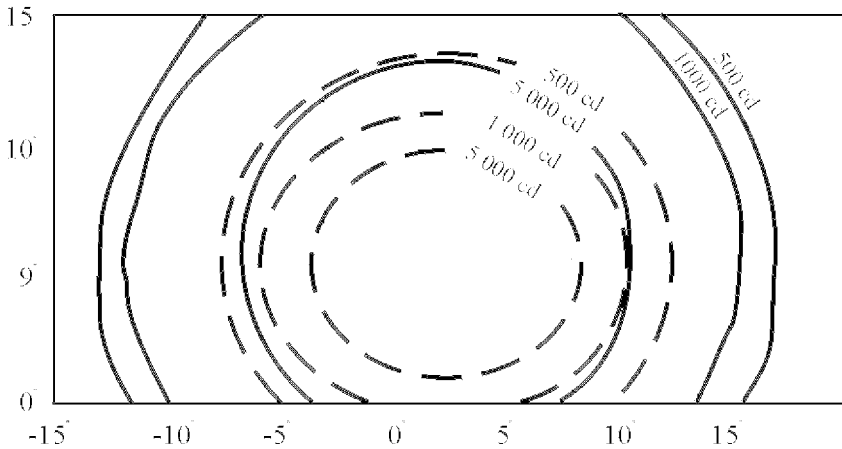

Figure 15-7 Isocandela diagram EL-AT [cd], threshold light (green light)

The lights installed within approximately 2 m of the ground are supported by tubes or tripods attached to frangible fittings at ground level. The mechanical strength of the fitting should not be greater than 700 Nm for lights with the upper edge less than 360 mm over the level of the terrain. If the approach lights are higher than this, the strength of this light fixture may be correspondingly higher.

The inset lights should be resistant to dynamic effects caused by aircraft and ground vehicles passing over them. The basic mechanical requirement relates to the strength of the light cap expressed as a pressure applied on a surface unit. For a common inset light with a diameter of 300 mm, the required static strength of the cap shall be 230 kN. In addition, the temperature at the

point of contact between the inset light and the tyre of an aeroplane created by temperature transfer, or by heat radiation of the lamp, should not exceed 160 °C during a 10 minute exposure.

A low-voltage cable from the insulation transformer to the light is designed for a voltage of 250 - 760 V. The insulation resistance of the light should be at least 2 MΩ. They must operate within a range of temperature from – 40 °C to + 55 °C. The fittings of elevated lights must be constructed so that the exchange of a damaged or broken light can be quick and uncomplicated.

With inset lights, the principal factors relate to the security of the fitting, the service life, the light source and speed of change of a cap with its optics *in situ*. The light bulb in the cap of an inset light should be changed in a workshop. It is also important that an inset light should resist damage by winter maintenance equipment like snow ploughs.

15.2.2 Characteristics and Components of Airport Lighting Systems

15.2.2.1 Approach and Runway Systems

15.2.2.1.1 Non-Instrument and Instrument Runways

Lighting systems of moderate light intensity are used for non-instrument and instrument runways under VMC conditions at night. It is often sufficient to construct only runway edge lights, runway threshold and end lights for non-instrument runways.

If possible, it is advisable to construct a simple approach lighting system so as to improve the directional guidance. This is a firm requirement for instrument runways.

The simple approach lighting system consists of a single row of lights on the extended centre line of the runway, out to a distance of 420 m from the runway threshold with a crossbar at a distance of 300 m from the runway threshold (Figure 15-8). The simple approach system may consist of individual lights, or of short lighting bars, called barrettes. The effect of a barrette is created by at least three lights located next to each other. The runway edge lights and the threshold and runway end bars should be located at the runway edge, or at the most 3 m from its edge.

Omnidirectional lights are used for simple approach systems and for edge lights for instrument runways and for non-instrument runways that are to be used under VMC at night. The omnidirectional lights provide guidance not only in the direction of approach and take-off, but because they give light in all directions, they also provide guidance for circling flight. Some types of lights combine the properties of reflector and omnidirectional lights. The combination of one omnidirectional light and two reflector lights that have been used for a precision approach runway

has now been substituted by a single light unit. It represents an important capital cost saving.

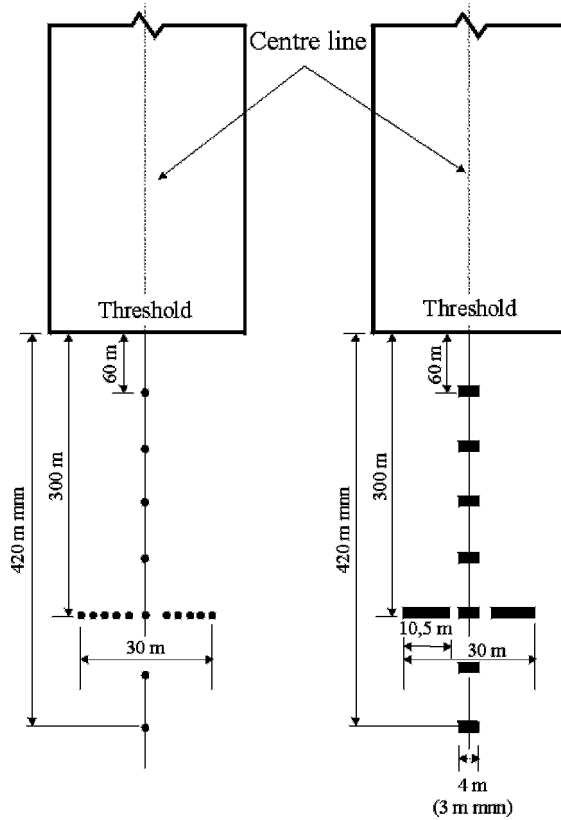

Figure 15-8 Simple approach lighting systems

(Source Annex 14, Aerodromes, Volume I, Aerodrome Design and Operations)

The Thorn company's EL-EAH light is an example of such a light. The ICAO requirements for lights on runways with a width of 60 m are fulfilled with a power of only 150 W, while for runways with a width of 45 m, 100 W is a sufficient input with reserves of 20 to 50% at a medium light intensity.

The light (see Figure 15-9) weighs only 1.9 kg and has excellent aerodynamic properties. Resistance to wind and jet engine blast was tested in a wind tunnel, and it is well above the required 560 km.h^{-1} . Rust resistance is provided by the use of aluminium and stainless steel. The optical system is formed by a diopter of heat resistant glass and two Fresnel lens. The optical system bearer is formed by a solid aluminium casting, which in addition ensures good heat removal.

Changing the lamp bulb is very easy and quick, which is particularly important at aerodromes with

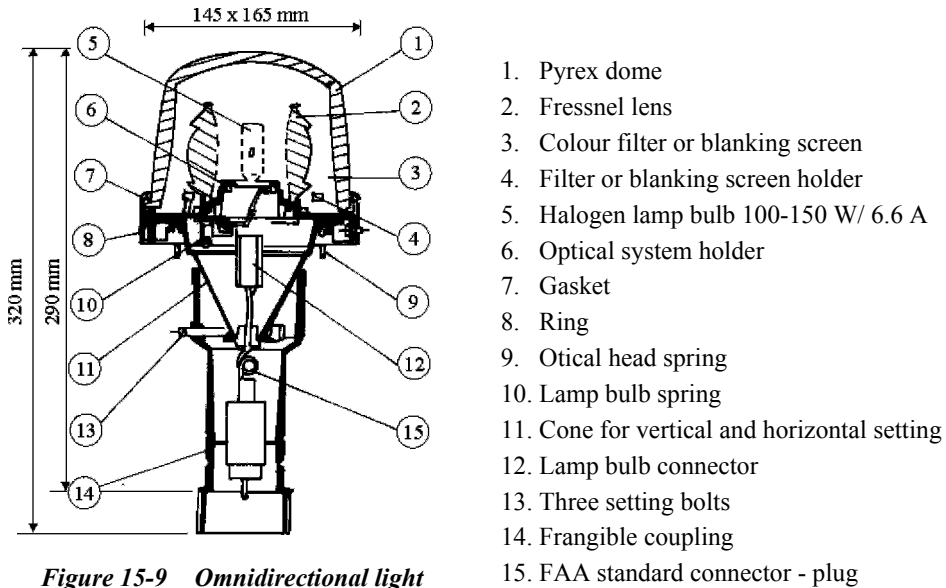

Figure 15-9 Omnidirectional light

a high traffic density or severe climatic conditions. The lamp bulb is equipped with a connector. The whole upper part of the light is usually changed for a new one, the lamp bulb being checked in the maintenance workshop. Changing the lamp bulb does not usually require more than 30 seconds. The mounting for the light is frangible (guidance on design for frangibility is contained in the Aerodrome Design Manual).

15.2.2.1.2 Precision Approach Runway

A Category I runway should be equipped with a Category I approach system. A diagram of the lighting system is shown in Figure 15-10. Two types of approach systems have been approved as a world-wide standard, an older type system, CALVERT and a newer type, ALPA ATA. The systems differ not only in the location of the lights, but also in the types used.

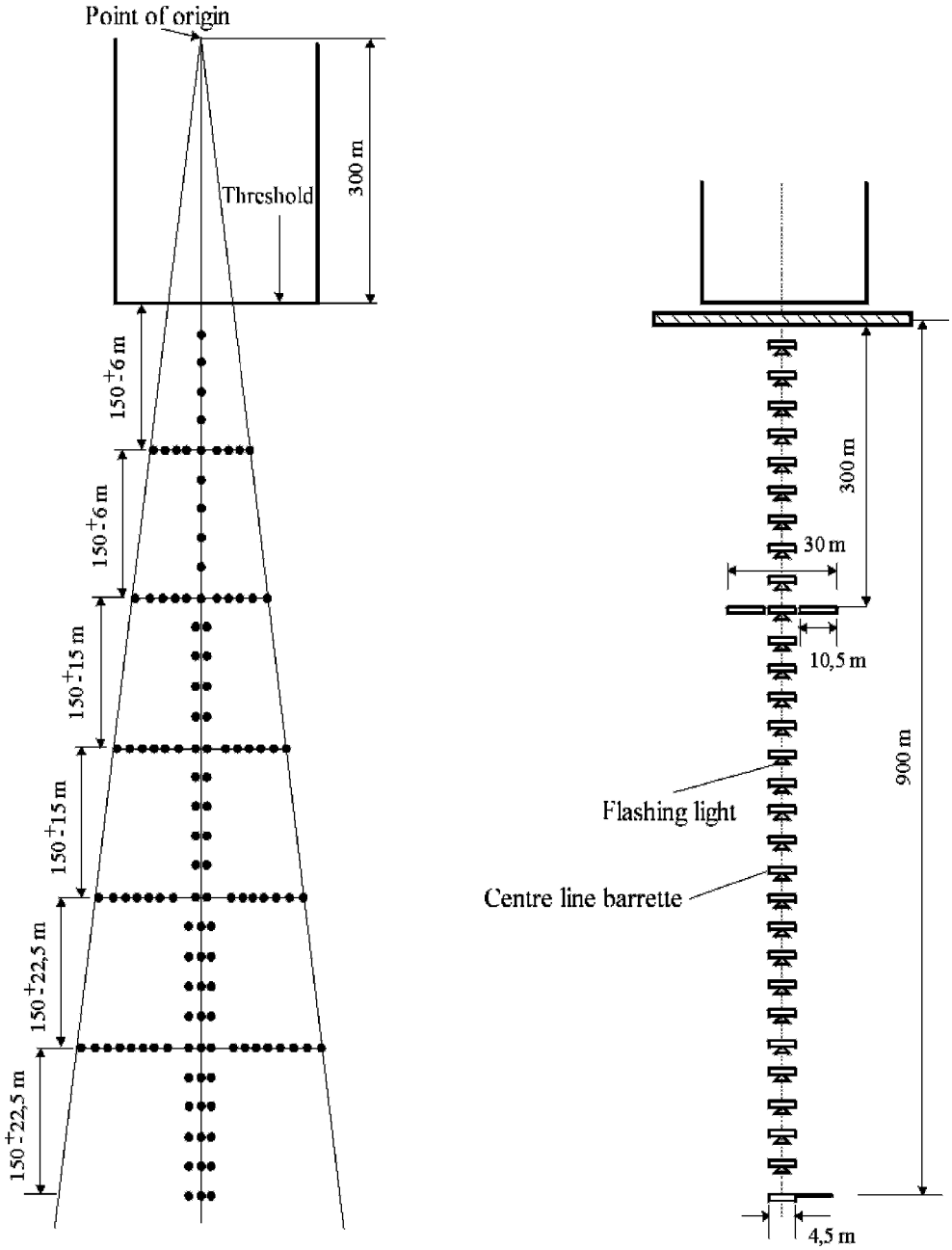

Figure 15-10 Precision approach Category I lighting systems
left – CALVERT, right ALPA-ATA

(Source: Annex 14, Aerodromes, Volume I, Aerodrome Design and Operations)

In addition, the ALPA ATA system has sequenced flashing lights, which more easily distinguishes the lighting system from other light sources in the aerodrome surroundings and gives positive identification of the runway. The sequenced lights flash twice a second. The flash moves along the system towards the runway threshold. The time of each flash is so short that it does not dazzle the crew of an aircraft. The flash easily penetrates fog, and thus the pilot gets information about the runway centre line orientation several seconds earlier than from approach light systems with steady lighting. A high voltage supply for the discharge lamps for the sequenced flashing lights is provided from a control box, which is fixed to the light support or is located in the ground.

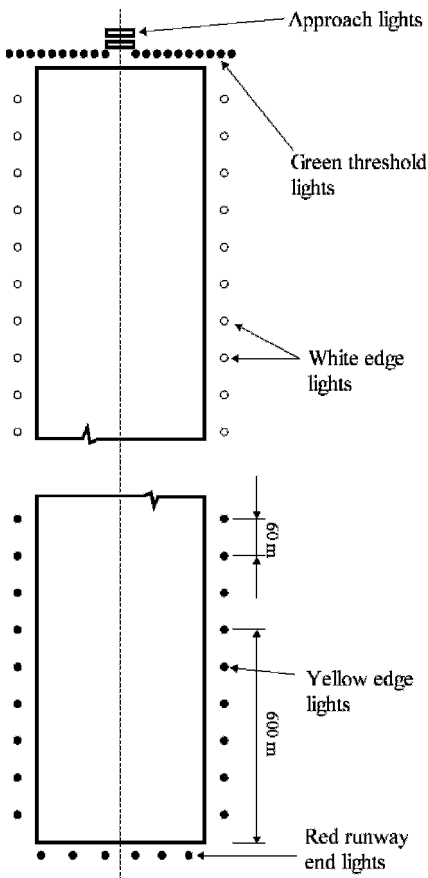

Figure 10-11 Runway lighting - precision approach Category I runway

ICAO states the requirements for the lights' properties, including the character of the white colour of the light and the mean light intensity in a defined beam of 20 000 candelas [cd]. The requirements are usually complied with by reflector lights.

Threshold lights forming a crossbar should be located at the runway threshold (see Figure 15-11.). The threshold lights produce a green light with a light intensity in a defined beam away from the runway of 10 000 candelas [cd]. Runway end lights are also located at the runway end, facing back down the runway. The lights inform the pilot of an aeroplane of the runway end position. They produce red light in a defined beam with a light intensity of 2 500 candelas [cd].

The runway edges are indicated with runway edge lights. They are either reflector or omnidirectional lights producing permanent white light with a mean light intensity of 10 000 candelas [cd] in a defined beam. In the last 600 m of the runway length (or half of the runway if the runway is shorter), the lights are yellow, and thus inform the pilot of the distance from the runway end.

The lights are supplied in the majority of cases by a serial distribution system and constant current regulator as described in Chapter 16. When the electrical power supply from the mains is interrupted, the supply is provided from a standby power

source. For a Category I runway, the electric power supply should be restored within fifteen seconds.

Category II of the ICAO meteorological limits is characterised by a runway visual range from 350 m to 550 m (or from 300 m to 550 m in the case of JAA limits) and by a decision height of 100 ft. These requirements are at present considered to be the limits for aircraft and crews to perform manual approaches and landings.

The Category I approach lighting system (CALVERT or ALPA ATA) is augmented for Category II operations with red side barrettes in the last 270 m before the runway threshold. The reflector lights have a light intensity of 5 000 candelas [cd] in a defined beam. The approach system also contains a set of flashing lights.

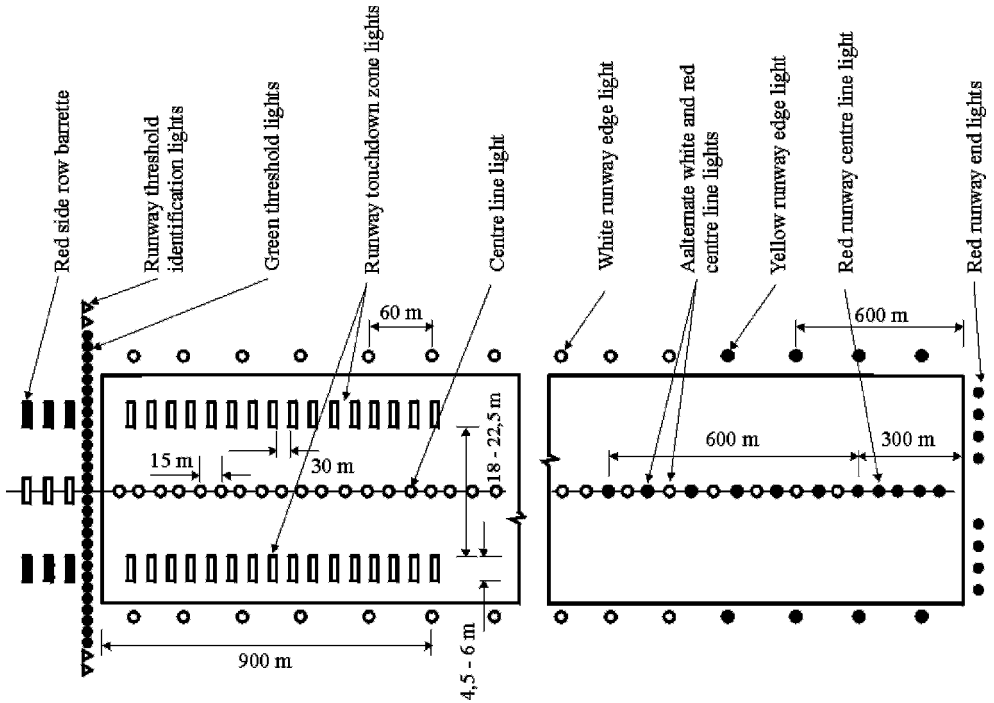

Figure 15-12 Inner 300 m approach and runway lighting for precision approach runway Categories II and III

A Category II runway has many more lights than a Category I runway (see Figures 15-12, 15-13). Besides the runway threshold lights, two other important additional lighting systems are incorporated. Under Category II meteorological conditions, the efficiency of the runway edge lights is reduced, and the runway centre line marked with inset lights becomes the most important

means of giving precision guidance to a pilot on the runway during landing, as well as during take-off.

The centre lights show steady white light of variable intensity. Inset white and red lights shall be placed alternately in the centre line from the last 900 m to 300 m from the runway end, while the centre lights show only red in the last 300 m. Another system indicates the runway touchdown zone, again by means of inset lights. The lights of the touchdown zone shall be located with a longitudinal spacing equal to that of the runway edge lights, and form an extension of the series of approach barrettes. Contrary to the lights of the approach system barrettes, which are red, the touchdown zone lights are white

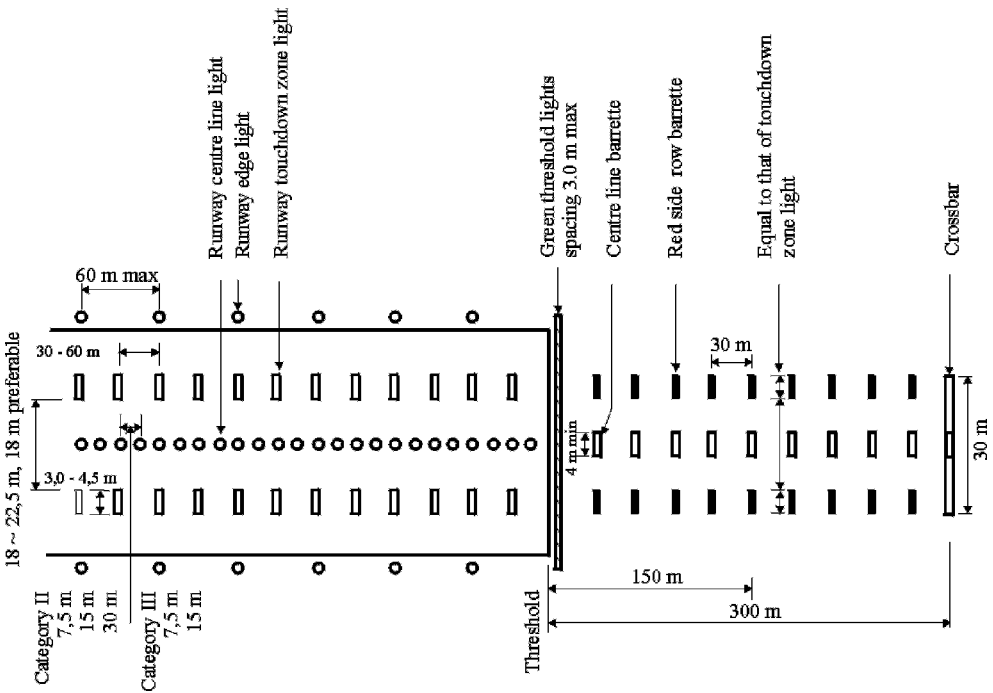

Figure 15-13 Runway lighting for precision approach runway Categories II and III

(Source: Annex 14, Aerodromes, Volume I, Aerodrome Design and Operations)

The inset lights are often run over by the wheels of aircraft. Their construction needs to allow for that, and they should be fitted flush with the pavement surface. Their egg-shaped body is made either of cast steel or of aluminium alloys. The lid is provided with cut-outs for the light beams. The optical system inside the light consists of a light source and reflector, glass prism and colour filter, as the case may be. The lights are stressed not only dynamically as the aircraft runs over

them, but also thermally, by the heat of the lamp. Even in heavy traffic conditions, in damp and in aggressive environments like winter maintenance, they need to be reliable. A white light with a light intensity of 5 000 candelas [cd] is required in a defined beam. The most advanced inset lights use a special light source, whose halogen lamp and a reflector form a single integrated unit. The halogen lamps have a minimum size and long service life. Effective optical systems allow the power requirements of the lights to be reduced, so reducing the heat inside the lights, and thus extending the service life of the lamps. The design of the lights is simple, the operation and maintenance is much cheaper than those of the earlier types of lights.

The IN-TO light made by the Thorn company (Figure 15-14) is an example of a modern inset light for taxiways. Optical prisms, which were glued in the older types of lights, are fixed into the light cap by means of a silicon seal. The light is provided with a double seal, the optical system being closed with a cover with a seal, and the other seal being between the cap and the mounting. The light power requirement is only 40 W.

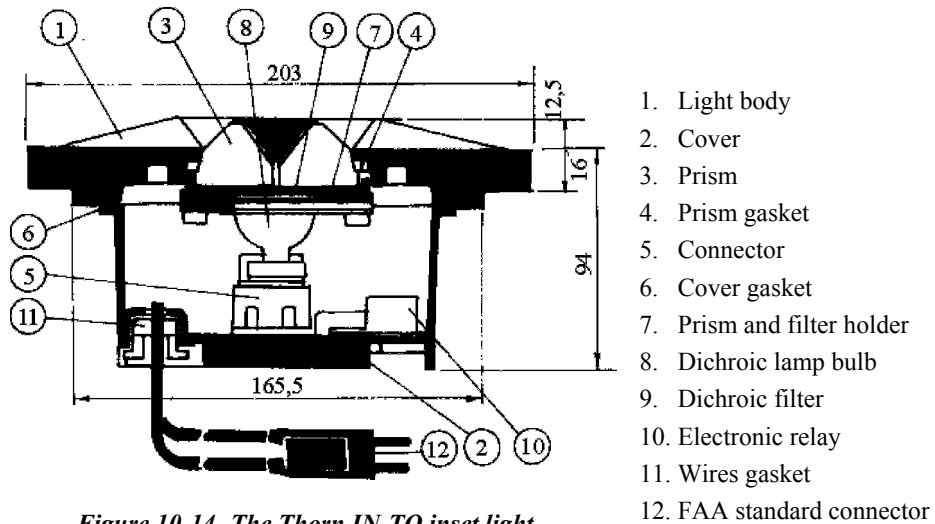

Figure 10-14 *The Thorn IN-TO inset light*

The connection between the electric power supply from the isolating transformer and the light cap is waterproof. The colour filters for obtaining the required light colour are dichroic – a thin layer is applied on the surface of colourless glass. Such filters have much greater light transmittance than the coloured glass filters. In the old types of ‘traditional’ coloured glass filters the luminous intensity decreases rapidly to 45% in case of a yellow filter 15% in case of a green 12% in case of a red and to only 2% of the original luminous intensity if a blue filter is used [45].

The upper part with the optical system is mounted in the lower part of the light, which is itself fixed into the pavement (Figure 15-15).

For an ICAO Category II runway, a higher reliability of the electric power supply is required. In the event of a mains supply failure, a standby power source should be able to recover the electric power supply within one second.

The runway equipment for Category II, with the Runway Visual range (RVR) limit reduced approximately by half that for Category I, represents a large increase of cost in comparison with a Category I runway. The number of lights and other components and equipment, such as isolating transformers, light fixings, constant current regulators, is many times higher. The cabling is also longer. The inset lights, which must be used in the touchdown rows and the centre line lights, are much more expensive than the usual elevated ones, and also their installation and maintenance are more expensive. The price of equipment for Category II runways is increased also by other required facilities.

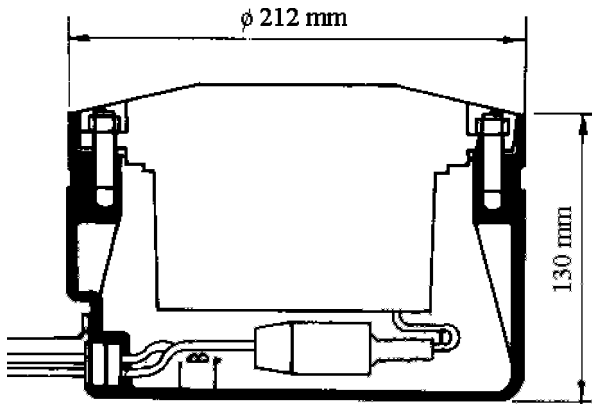

Figure 15-15 Lower part of the Thorn IN-TO inset light

The standby source of the ‘short break’ type for Category II is also more expensive than the standby source with automatic start, commonly used for Category I lighting systems. In addition, meteorological equipment, in the form of RVR measurement, and more comprehensive ILS precision approach systems are required for Category II.

Category III approaches are divided into sub-categories A, B and C. The basic difference compared with other categories is that in Category III the landing itself is conducted automatically, and the lighting systems serve the pilot only for monitoring the very final phase of approach and landing. The practical limit of the usefulness of the lighting systems may be considered to be Category III B. When Category III C conditions exist, only non-visual approach methods can be applied. Landing and guidance of an aeroplane to the runway is fully automated.

The location of lights of the Category III approach and runway systems does not differ from the Category II. The edge lights are not normally visible in Category III conditions, so the lighting systems of taxiways should be complemented with centre guidance from inset lights, which are green, or green and yellow from the runway centre line to the perimeter of the ILS/MLS critical or sensitive area.

For Category I, II and III approach systems, reflector type elevated lights are used (Figure 15-16). They should be light-weight, highly resistant against corrosion and jet blast. The reflector is usually made of aluminium, chemically polished and protected with a cover of light-weight aluminium alloy. The diffuser for green and red lights is made of heat resistant glass, and therefore no colour filter and its attachment are needed. The cooler in the rear part of the reflector lamp significantly extends its service life.



Figure 15-16 Honeywell High Intensity Approach Light Type ATR 12
(Photo: Courtesy Honeywell Airport Systems)

Changing the lamp is facilitated by easy access to the lamp after lifting the rear plastic cover. The lamp is equipped with a connector. The power requirement is very small, being only 150 W for a white approach light, and 200 W for a threshold light, the ICAO requirements for light intensity still being fulfilled with reserves of 20 to 40%.

15.2.2.2 Approach Slope Indicator Systems

Where an improved visual guidance of an aeroplane should be provided on the approach, the

runway must be equipped with a visual approach slope indicator system. The approach slope system should be provided if:

- the runway is used by jet aircraft
- the approach is to be performed over a water surface, or over a featureless terrain (desert, snow-covered terrain) in the absence of sufficient incidental lights in the approach area by night
- misleading information is produced by surrounding terrain or runway slopes (see Figure 15-17)
- dangerous objects are present under the approach path
- the terrain beyond the runway ends involves serious hazard for an aeroplane if it touches down before the threshold or overruns beyond the runway end
- the aeroplane may be subjected to turbulence, wind shear or micro bursts during approach.

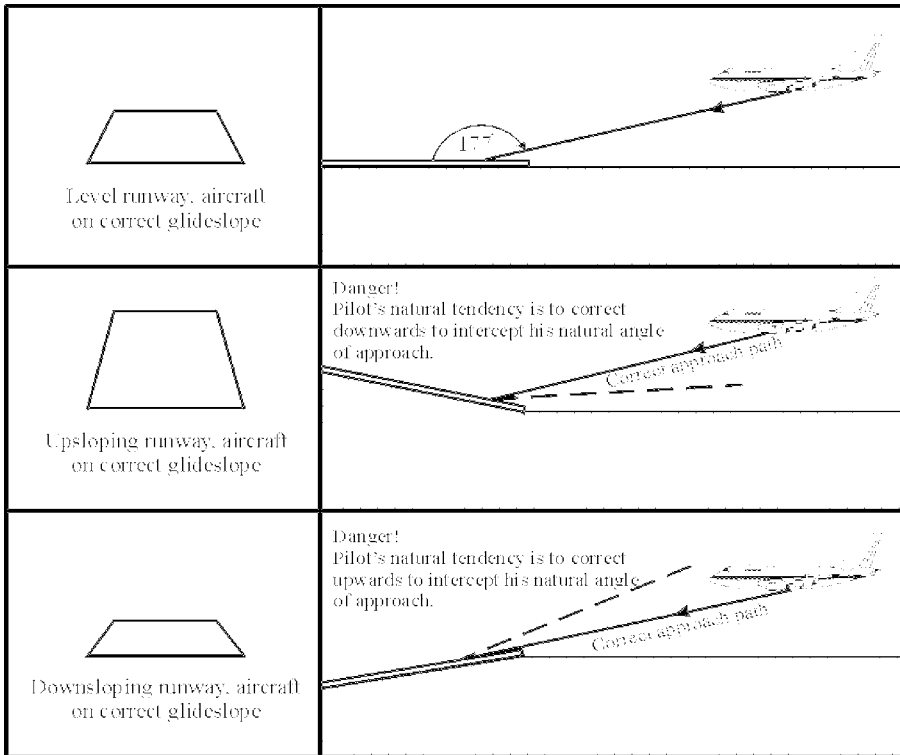

Figure 15-17 Possible illusions due to the longitudinal runway slopes

Visual approach slope indicator systems are installed at virtually every civil aerodrome. An additional advantage is that they correct any tendency to fly low in heavy rain. The most used is

the Precision Approach Path Indicator (PAPI) system, and some countries still use the Visual Approach Slope Indicator System, the Visual Approach Slope Indicator System (VASIS), or T-VASIS in Australia and New Zealand.

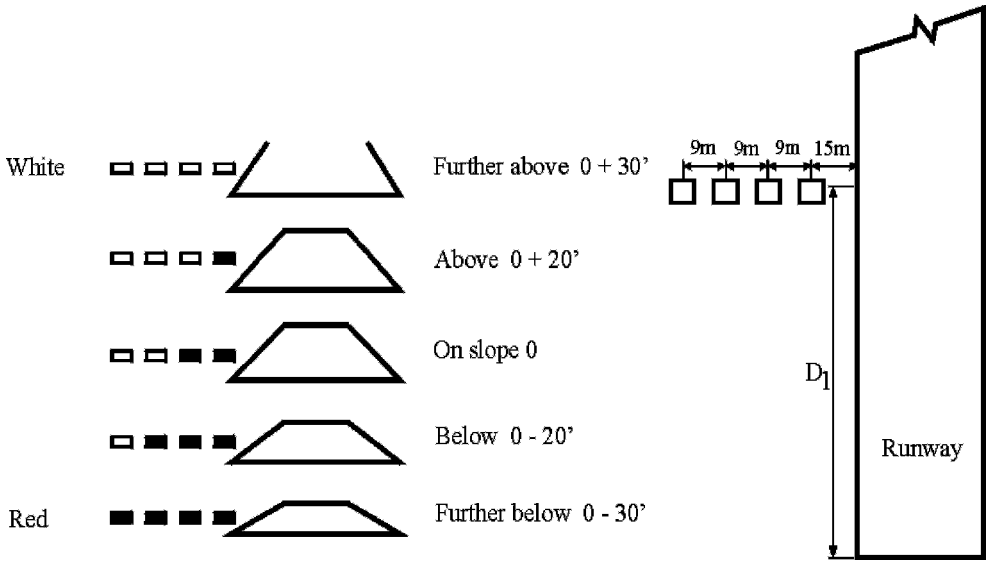

Figure 15-18 PAPI light units settings and indications

The PAPI system is not only a more precise vertical guidance of the pilot during the approach down the glideslope, but it also has fewer lights in the system than the other two systems. PAPI gives a better indication of rates of change of angle above or below the glideslope. The costs of acquisition and construction are lower, and it is more economical to operate.

The PAPI visual slope light unit has a light beam horizontally divided into two sectors, red in the lower part and white in the upper part. The geometrical arrangement and horizontal adjustment of the lights ensure that the pilot of an aeroplane can see red sectors of the two lights nearest to the runway and white sectors of the other two lights when on the correct approach slope. If the aircraft falls below the glideslope, the white colour of the other two lights changes to red at precise angular changes depending on the extent to which it is below the nominal slope. If the approach becomes higher than it should be, the red lights change to white. The geometrical arrangement of the approach slope indicator systems and the angles of adjustment are shown in Figure 15-18. The lights can be repeated on the other side of the runway in order to improve roll perspective, but both sets must give completely consistent indications.

The construction of the visual slope light units does not resemble reflector or omnidirectional

lights in any aspect. The light beam should be very sharply divided into a white and a red sector. The optical system contains one or two lenses, a red filter and a reflector.

It is normal to fit two optical systems in one light. The required power is then 2 x 200 W. In the APAPI systems – approved for aerodromes without international traffic, lamps of 45 and 100 W are also used, because the required range of the systems is lower. The required range of the PAPI system is 7.4 km on a clear day. The range is, in fact, usually 12 to 15 km, and, on a clear night, it can be 30 km and more.

The American Federal Aviation Administration (FAA) has approved another type of approach slope indicator system. It is the Pulse Light Approach Slope Indicator (PLASI) made by the DeVore Aviation Corporation (Figure 15-19). The equipment may be used on aerodromes as well as on heliports. The equipment consists of a single light fitting. As with the VASIS and PAPI systems, PLASI also uses white and red lights to indicate the required vertical position of an aeroplane.

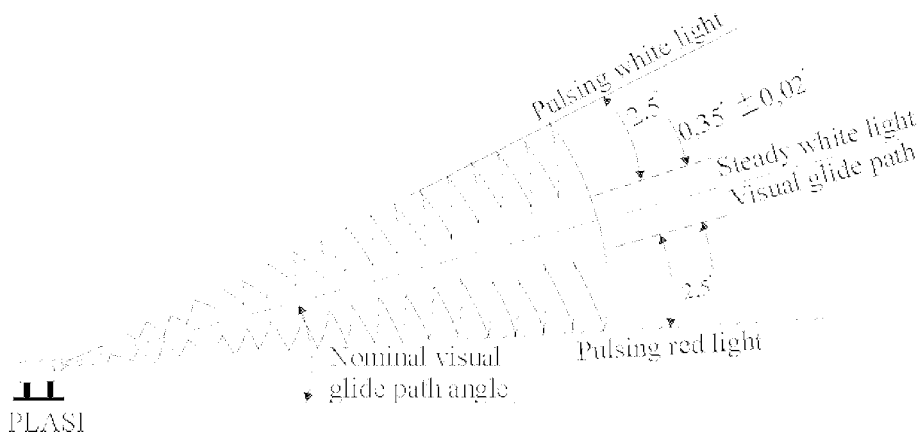

Figure 15-19 Principle of the Precision Light Approach Slope Indicator (PLASI)

A constant white light indicates that the aeroplane is correctly located relative to the glidepath. A pulsing white light indicates that the aeroplane is above, and the pulsing red light that it is under the glidepath.

The transition between the position on the glidepath and off it is very sharp. The bigger the deviation of an aeroplane from the glidepath, the higher is the frequency of flashing. Nearer to the axis, the light pulses more slowly. Thus the pilot of an aeroplane easily acquires information on the extent of deviation of the aeroplane from the glidepath axis. The PLASI may be simply adjusted to an arbitrary glidepath angle from 0 to 90° above the horizon. It requires only a small space for its installation. Therefore it is usable also for heliports on structures at sea.

The equipment has a battery with discharge lamps. When there is a failure of the light source, the battery is automatically switched on. The light output is controlled automatically by a photoelectric cell. Both the purchase and operating costs of the PLASI are less than those with the PAPI system.

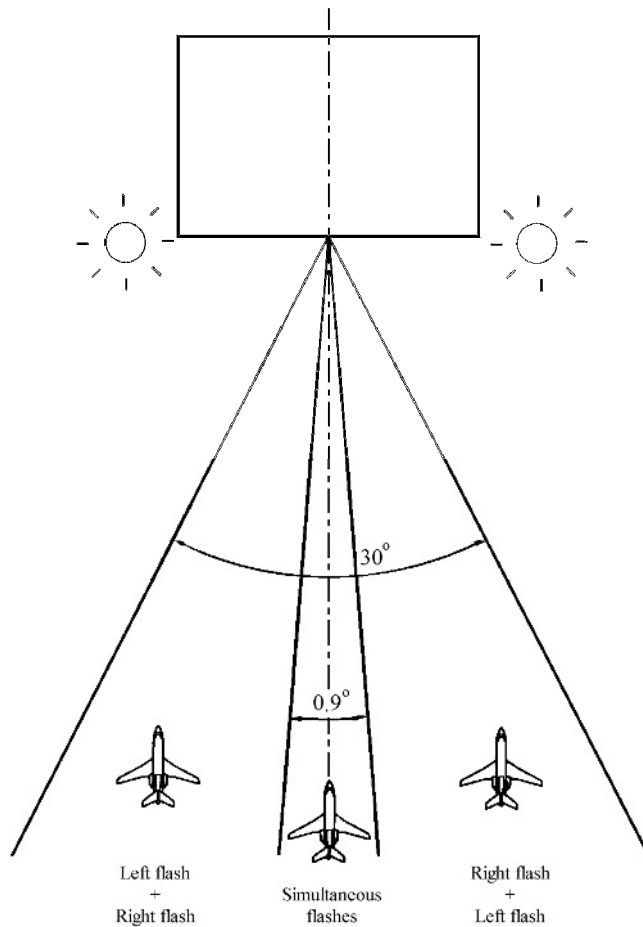

Figure 15-20 Principle of System of Approach Azimuth Visual Guidance (SAGA)

For airports and heliports a new system of azimuth guidance was developed by the Thorn company. It is the System of Azimuth Guidance for Approach (SAGA) (Figure 15-20). The system includes two lights with unidirectional rotating beams placed symmetrically on each side of the threshold.

The pilot receives, every second, a luminous message comprising two flashes issued in sequence by the two rotating beams of the system. When the aircraft flies inside a 0.9 degree wide angular sector, centred on the approach axis, the pilot sees two lights flashing simultaneously.

When the pilot flies inside a 30 degree wide angular sector, he sees the two lights flashing with a delay which varies between 60 and 330 ms according to the aircraft position in the sector. The further the plane is from the axis, the greater the delay, the sequence effect showing the direction to the axis.

15.2.3 Heliport lighting systems

Some visual systems designed for aerodromes are also used for lighting heliports. However, helicopter performance characteristics and the type of heliport operation impose special requirements on the heliport lighting systems. In general night and restricted visibility operations require lighting (optical navigation aids) and illumination (ground illumination) of the heliport and heliport equipment.

A heliport approach lighting system is usually installed when it is necessary to specify a particular approach direction. The approach system must be at least 210 m in length and should consist of a row of white lights placed at intervals of 30 m. There is a crossbar 18 m in length at a distance of 90 m from the perimeter of the final approach and take-off area. The lights beyond the crossbar may be steady or sequenced flashing to give a positive identification of a heliport and to distinguish the approach lights from the background lighting.

Table 15–3 HAPI signal format

SECTOR	FORMAT
Above	Flashing green
On slope	Green
Slightly below	Red
Below	Flashing red

If the heliport is situated in an area where obstacle clearance or noise procedures are prescribed or it is essential to fly precisely defined track towards the final approach and take-off area, a visual alignment guidance system (VAGS) should be used. A System of Approach Azimuth Visual Guidance (SAGA) (Figure 15-20) is one of the currently available systems fulfilling specifications for visual alignment guidance.

Where installation of VAGS is necessary or if a helicopter requires stabilized approach, some type

of visual approach slope indicator should be installed at the heliport. For this purpose a standard PAPI or APAPI system could be used. There is also a special system designed for heliport operations only - Helicopter Approach Path Indicator (HAPI) (Figure 15-21). The signal format from HAPI is similar to PLASI (Figure 15-19). HAPI signals determine four sectors by different colour and light formats in the horizontal plane between 1 degree and 12 degrees above the horizon (Table 15-3).



Figure 15-21 *Typical HAPI installation at elevated heliport, (Photo: A. Kazda)*

The advantage of HAPI against other standard systems is that the equipment consists of a single light unit and could also be used for helidecks or elevated heliports.

For night operations the Final Approach and Take-off Area (FATO) should be marked by white omnidirectional lights placed along the edges of the FATO. At either surface level or elevated heliports lighting systems, perimeter lights or Arrays of Segmented Point Source Lighting (ASPSL) or luminescent panel (LP) lighting could be used for the Touchdown and Lift-Off area (TLOF). Floodlighting is also allowed for TLOF identification at surface level heliports. The perimeter lights must be green fixed omnidirectional lights placed along the edge of the TLOF.

Where applicable the heliport lighting equipment can be further complemented by an aerodrome beacon, heliport beacon, winching area floodlighting and aiming point lights. At each heliport approved for night operations at least one illuminated wind direction indicator must be installed.

At aerodromes, the runway lengths increased during over time and so has the number of lights and lengths of cable, but the dimensions of heliports has remained practically the same. Heliport lighting systems are placed on a relatively small area. For this particular reason the traditional serial distribution system with constant current regulators used at aerodromes is more complicated and more expensive. A parallel supply system is used at heliports. Both elevated omnidirectional or inset lights are connected by parallel feeder system to a simple distribution and control box.

For omni-directional lights and the illuminated wind direction indicator there is no need for variable light intensity setting. In the case of approach lights and visual approach slope indicators an intensity setting of usually 10%, 30% and 100% is used for steady lights and 3%, 10% and 100% for flashing lights.

15.2.4 Lighting of Obstacles

Usually there are objects around an airport which penetrate the obstacle clearance limits (see Chapter 3) or may create a hazard to aeroplanes. If the object is immovable but could, according to aeronautical study, affect safety, the object should be marked. If the aerodrome is used at night, it should also be lighted. The way the obstacle is marked or lit depends on the object's character, its position and height, and the type of aerodrome operation. In general the obstacle lights could be divided into three groups:

Low-intensity obstacle lights

Low-intensity obstacle light Type A or B – red light with peak intensity between 10 – 32 cd/m². Low intensity lights could be used for marking of less extensive objects with height less than 45 m above the surrounding terrain (Figure 15-22).

Medium-intensity obstacle lights

Medium-intensity obstacle light	Type A – white flashing, with effective intensity of 20 000 cd/m ² .
	Type B – red flashing, with intensity of 2 000 cd/m ² .
	Type C – red fixed, with intensity of 2 000 cd/m ² .

Medium-intensity obstacle lights should be used where an early warning of danger is required or the object is extensive or its height above the surrounding terrain is greater than 45 m. When medium-intensity obstacle lights are used it is usually not required to use colour markings for an object.



Figure 15-22 Low intensity neon obstacle light, (Photo: M. Ma'aš)

High-intensity obstacle lights

High-intensity obstacle light Type A or B are white flashing with effective peak intensity of 100 000 - 200 000 cd/m². These lights should be used for objects with height of 150 m and more above the surrounding terrain or for recognition of towers, wires and cables by day. The light characteristic is not omni-directional as is the case with low or medium intensity lights, but the flash is directed by mirrors. For marking high towers or pylons usually 4 - 6 high intensity lights are necessary.

The popularity of a LED type (Light Emitting Diode) of low and medium intensity obstacle lights has grown recently. This is not only due to a very low energy consumption, i.e. about 12 W in case of a low intensity light, but also its extremely long service life – more than 100 000 hours. When properly installed the LED type light is practically ‘maintenance free’. Because of its low energy consumption it is possible to use photocells as energy source.

As a light source for medium intensity obstacle lights a xenon discharge lamp is usually used. To meet the light intensity criteria, some types of lights work in dual regime with white flashes during a day and red flashes in night.

15.2.5 Light Control

15.2.5.1 Remote Control Equipment

The remote control equipment is a part of the aerodrome lighting system. It serves not only to regulate, but also to monitor the lighting system operation. Monitoring equipment that operates in real time is an essential requirement for approving the lighting systems for Category II and III conditions. It is necessary to control from a distance a large number of constant current regulators, and at the same time to assess a large amount of feedback data on the condition of the lighting systems. The remote control system rationalises the operation so that:

- ➔ the air traffic controllers are not overburdened by handling numerous control elements and redundant information on the condition of the lighting systems
- ➔ the maintenance personnel may receive detailed information on the condition of the lighting systems, as a base for their activity. That information is usually brought together in a central control board.

The systems at small aerodromes and heliports, where the number of constant current regulators is small, do not require complex control equipment. From each constant current regulator, a multi-colored control cable is led out, by means of which the orders and feedback signals are transmitted directly to a simple board in the control tower.

At aerodromes equipped with Category I, II and III precision approach systems, a whole range of constant current regulators operates simultaneously, often to different degrees of light intensity. Movement of aircraft on more complex systems of taxiways is controlled by switching on the lights for the appropriate standard taxiing paths. Pre-programmed control systems prevent the air traffic controllers from being overburdened by a complicated control situation in such cases. For example, in the ‘take-off’ programme, the approach system is not required to be on. The air traffic controller chooses a runway direction and the degree of light intensity, depending on the runway visual range or according to the pilot’s request. The programme ensures the activation of the

lighting systems necessary for take-off with the required degrees of light intensity. In addition to control panels, clear diagrams are also used, where the activation of the particular lighting systems is shown. Lamps were initially used to show this, later being replaced by light emitting diodes (LED). The air traffic controller was informed of a failure of a part of the lighting systems or constant current regulators by the flickering of a lamp or a diode, and by aural signalling that can be switched off if necessary.

Current practice makes full use of computer technology for the control of the more complicated Category I systems, but in particular for Category II and III systems. This has both operating and economic advantages. The expensive multi-cored cable is substituted by a cheap two- or four-cored one. Large lighting systems and sub-systems, safety lighting bars and STOP lighting bars may be controlled and monitored, together with the power system of the aerodrome and meteorological and radio navigation equipment.

The air traffic controllers regulate the lighting systems through several controls, and the information is presented in a summarised form in monitors. For example, in the event of a failure of an important system, the air traffic controller may receive only the information that the lighting system is not capable of operation under Category II conditions, but that it complies with the requirements for an operation under Category I conditions. For maintenance purposes, the monitoring system provides detailed data on the condition of the equipment failure in terms of reduction of insulation in a loop, the number of lamps not meeting the required output, and the like. In real time, the monitoring systems record the condition of the lighting systems, air traffic controllers' activity, failures and their repair.

Recently, the so called 'addressing system' of monitoring and control has been used for complex light systems of taxiways and stop-bar lights. Two systems of communication are used, either a serial feeding cable, or a special cable network and optical cables.

Each light in a serial loop has its own precise address, and the system allows not only monitoring, e.g. it identifies two consecutive unlit lights, but also the control, individually or in groups of stop-bar lights, sections of runway centre line lights, etc.

15.2.5.2 Single Lamp Control and Monitoring

Current aerodrome lighting systems need separate series circuits when switching. In the case of lighting systems with small number of lights like stopbars, sections of taxiway centre line or PAPI systems, every circuit needs a separate cable and a constant current regulator in the traditional

solution (Figure 15-23). Such system design results in high installation and operation costs. In traditional systems the lamp failure monitoring function is able to detect the number of burnt out lamps only, but not their positions.

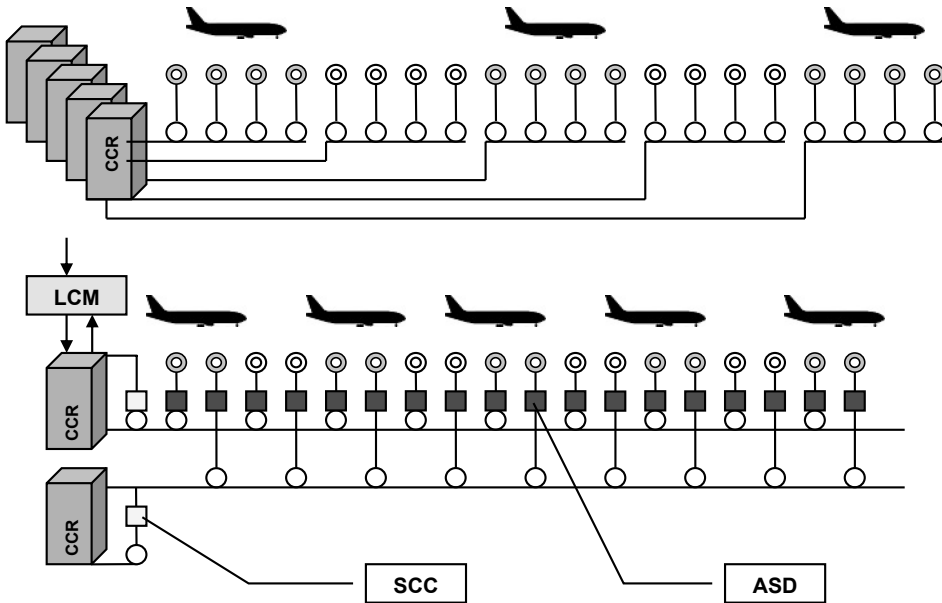

Figure 15-23 Traditional configuration (above) and the single lamp control and monitoring (below)

(Source: Honeywell Airport System brochure)

The single lamp control and monitoring system developed by Honeywell Airport Systems permits the control and monitoring of single lamps or groups of lamps within one series circuit [176]. At large airports with complex systems of taxiways the single lamp control is a cheaper and safer alternative for aerodrome ground lighting systems. The control of a lamp, or group of lamps, is performed by an Addressable Switching Device (ASD) which is plugged in between the isolating transformer and the lamp and is controlled via signals on the standard series circuit cable. Data transmission is achieved by a current modulation in the series cable. The Constant Current Regulators (CCR) are controlled by the Lamp Control and Monitoring (LCM) unit and further distributed through the Series Circuit Coupler (SCC).

Another advantage of the single lamp control and monitoring is, depending on the weather conditions, the activation of a variable number of taxiway or runway centreline lights. During Category II or III conditions all lights must be active while during good visibility the distance between the lights can be doubled. This results not only in energy savings but it also increases the

service life of lamps. Single lamp control and monitoring can also be used for a particular lamp failure monitoring. This allows the introduction of a system of preventive maintenance and quality control for a precision approach runway Category II or III, and to reach standards of light serviceability in line with Annex 14, Volume I, Chapter 10.

There are also other companies offering similar solutions for taxiway lights control. Most of these applications could be used in the Surface Movement Guidance and Control Systems (SMGCS). The main purpose of providing an SMGCS or A - SMGCS (A - Advanced) is to enhance safety and capacity of aerodrome ground operations in particular during low visibility operations. In the 'visual' part of the system the pilot receives the information required for taxiing primarily from the taxiway centre line lighting, from stop bars and from taxiway guidance signs. The taxiway centre line lighting is only activated on the respective cleared areas. This lighting is switched on and off automatically by the taxiing guidance system after clearance or with monitoring from controllers. The stop bars established from red inset lights are installed right through the taxiway and they prohibit overruns when switched on. The stop bars are positioned in particular on the access taxiways to the runway in order to prevent the possibility of a runway incursion. Additionally, the stop bars are used at the taxiways to control taxiway traffic. More information on the A- SMGCS is given in the Chapter 17.

15.2.6 Lighting Systems Construction and Operation

15.2.6.1 Lighting Systems Design and Installation

Although ICAO and FAA have implemented a high degree of standardisation and uniformity into lighting systems in aerodromes, the installation of lighting systems is usually specific to each case. It is affected by the following factors:

- geometrical characteristics and arrangement of runways, taxiways and stands
- arrangement of power supply components (transformer substations) and the aerodrome control tower
- soil and climatic conditions
- previous habits and experience of the lighting systems operator, which are usually taken into account in the project
- anticipation of future additions to the system.

A renewal of the lighting systems is often connected with a reconstruction of the runway surface. The speed and quality of the works are influenced by the following factors:

- thorough preparation of the work, including the scheduling of work

- harmonisation of civil and electrical aspects of the work
- phasing the works to make the optimum use of climatic conditions.

Utilisation of an optimum season of the year is of principal importance, in particular in northern regions, where a favourable climate period is very short. Low temperatures and high air humidity have a negative impact in particular on installation of inset lights by gluing with epoxy resins into a concrete or asphalt pavement, and on insulation of cable couplings.

15.2.6.2 Maintenance of the Lighting Systems

The role of the lighting system maintenance personnel is to ensure that the equipment functions reliably during its service life. This is effected by:

- the technical quality of the lighting systems
- the quality of the project design
- the quality of construction works
- the maintenance organisation and equipment
- the level of knowledge and skills of the maintenance personnel
- the timeliness and availability of information on the real condition of the equipment in operation.

The most important parameter of the lighting systems to be monitored is the number of serviceable lights. The requirements for ensuring the serviceability are specified by Annex 14, Aerodromes, Volume I, Aerodrome Design and Operations, Chapter 9. A light is considered serviceable if its light intensity in the required direction has not dropped under 50% of the light intensity of a new one.

The requirement for the Category I systems is that at least 85% of lights are serviceable in:

- precision approach system
- threshold lights
- runway edge lights
- runway end lights.

Considerably more stringent requirements apply to the Category II and III systems. At least 95% of lights should be serviceable in the following sets:

- inner 450 m of the Category II and III approach system– runway centre line lights
- threshold lights
- runway end lights

Furthermore, the following should be serviceable:

- at least 90% of touchdown zone lights
- at least 85% of lights of approach systems to a distance of 450 m from the runway threshold, and further
- at least 75% of runway end lights.

Besides the above requirements, there are supplementary conditions, such as the requirement that no two consecutive failed lights shall occur in the runway and taxiway centre line systems. In the STOP- bar lights, only one light failure is allowed.

With the standard twenty year service life, the first cost of the lighting systems is a relatively small part of the total life-cycle costs. The quality of the equipment in its entirety is of prime importance.

The main effects that are directly connected with the costs on maintenance are:

- the price and service life of the light bulbs
- the resistance of the lights and fittings to corrosion
- the resistance of the lights and fittings to the effects of air traffic, such as the impact of the jet engine combustion products, snow and ice cleaning equipment
- the quality of the cables and connectors
- laying the cables into cable ducts and the isolating transformers into easily accessible shafts
- the reliability of the constant current regulators and other electric equipment
- the reliability of the remote control and monitoring equipment, and the timeliness and availability of information on the lighting system condition
- low power requirements of the lights and the related costs of electrical energy.

These costs are all influenced by the costs of the materials and labour. It is best to use the same team of workers who also maintain other electric equipment. They should also participate in the installation of a new lighting system. In practice, the system of daily, weekly, monthly and half-yearly maintenance checks has been proved to be desirable. The maintenance activities are recorded in service logs. The organisation of the maintenance is designed in the light of previous

habits and climatic conditions. Where the climatic differences between summer and winter are big, and inset lights are in the majority, it is convenient to carry out extensive maintenance before the arrival of the winter season, including the complete replacement of lamps in the inset lights, and another extensive maintenance intervention in spring. The maintenance in winter months may be made easier by laying the cables into cable ducts, putting the isolating transformers into shafts, and by a proper construction of inset lights.



Figure 15-24 Solar LED light Model A702C has low power requirements, extremely long service life and is practically maintenance free
(Photo: Courtesy Carmanah Technologies Corp.)

The effectiveness and speed of reaction in the maintenance of the lighting system is influenced also by equipment as well as personnel. It is necessary to have a suitable vehicle with radio communication and radio telephone. In the vehicle, equipment should be available for inspecting the cable network, also a compressor and wrenches for maintaining the inset lights.

The light intensity of inset lights is often impaired by impurities in the optical system, such as the remains of rubber from aircraft tires. In order to maintain a permanent light intensity to the required limits, it is necessary to clean the inset lights. Cleaning may be carried out by compressed

air containing crushed walnut shells or olive stone pips, compressed liquids, mechanical brushes, or a combination of these. Full cleaning of the optical parts of inset lights is carried out in maintenance workshops when the light bulbs are replaced.

15.2.7 Trends in Lighting Systems Development

It may be expected that the future development will use the serial distribution of aerodrome lighting systems, except heliports, where a parallel supply system will be applied. The manufacturers will make an effort to produce unified equipment, including a wide variety of normative requirements. Reduction of power requirements of the lights and utilisation of light sources with long service life provides the manufacturers with a competitive advantage. Operationally undemanding inset lights of good quality will find their implementation in East European countries in particular, in connection with upgrading the aerodromes to higher categories of meteorological limits.

A modern lighting system at the beginning of the third millennium will be characterised by small power requirements, high service life of components and light sources, and easy, quick and cheap maintenance (Figure 15-24). The control and monitoring systems will provide efficiency for the operators and diagnostics of the system condition for the needs of an effective maintenance operation.

16

ELECTRICAL ENERGY SUPPLY

Tony Kazda, Bob Caves and František Bělohradský

16.1 BACKGROUND

The consumption of electrical energy of a large international airport may be compared with that of a town with 15 000 to 30 000 inhabitants. Besides electrical energy required for the aids to air traffic operation such as lighting systems, radar, communication and meteorological systems, it is necessary to take into consideration electricity consumption in hangars, buildings and other airport facilities. This chapter will deal only with the supply and distribution systems of electrical energy for lighting systems and other equipment for air traffic operation.

16.2 ELECTRICAL SYSTEMS RELIABILITY AND BACK-UP

For lighting systems, telecommunication and radio-navigation aids, Annex 14, Volume I, Chapter 8 specifies the requirements for a standby electrical energy source in terms of the maximum switch-over time to a standby power supply. The requirement for a standby source may be fulfilled by constructing an independent supply of electrical energy to the aerodrome, connected with a 100 kV transformer station, or by a standby source complying with the required parameters. The decision to construct an independent supply line to the aerodrome should take account not

only of investment costs, but also the electrical energy supplier's pricing policy and the use that may be made of surplus electrical energy.

On small aerodromes, the power to all the equipment may be covered by a central standby source. On large aerodromes, the number of installations that must be safeguarded increases, as do the requirements for power output of standby sources and the distances between the installations. The requirements for standby sources vary considerably in switching time and in the required power output of the standby source, according to the kind and category of the aerodrome. The greater the distance of the installation from the standby source, the lower is the reliability of the whole system as a consequence of possible failures in transmission lines. Therefore in larger aerodromes it is not practically possible to cover the entire consumption by a single, central standby source. For that reason, a decision on the number of standby sources and their arrangement should be made not only on the basis of an economic assessment, but consideration should be given also to the reliability of the electrical energy supply. For Category II and III precision approach runways, the probability of failure of electrical energy should not be higher than 1×10^{-1} per year. The standby sources, which are in the majority of cases diesel generators, are usually located directly in the transformer stations that feed the lighting systems. A special separate room is established for them, in which a constant temperature should be maintained, exhaust gases off-take and dispersion should be provided, and the fuel store reliably designed to prevent fuel accident/incidents. There are also new independent standby generator systems in standard containers fulfilling these requirements. In the majority of cases, the radio-navigation and communication systems are backed up by battery sources with automatic switching.

The requirements for a standby source of electrical energy and switching time are given in the Table 16-1. According to Annex 14 Volume I, the switch-over time for lighting systems is defined as the time required for the actual intensity of a light measured in a given direction to fall from 50 per cent and recover to 50 per cent during a power supply changeover, when the light is being operated at intensities of 25 per cent or above.

In order to ensure those requirements are met, a whole range of technical solutions may be adopted. Besides an independent supply of electrical energy, some aerodromes have heating stations equipped with low pressure steam turbines and generators which can supply electrical energy to selected facilities (e.g. Praha – Ruzyně airport). This is termed co-generation. At some airports, the heating/power stations serve as the main source of electrical energy (e.g. Munich airport) and the connection to the 'public' high voltage line is the standby. The standby sources may be divided into the following groups:

Table 16-1 Secondary power supply requirements (Source: Annex 14, Aerodromes)

Runway	Lighting aids requiring power	Maximum switch-over time
Non-instrument	Visual approach slope indicators Runway edge Runway threshold Runway end Obstacle	2 minutes 2 minutes 2 minutes 2 minutes 2 minutes
Non-precision approach	Approach lighting system Visual approach slope indicators Runway edge Runway threshold Runway end Obstacle	15 seconds 15 seconds 15 seconds 15 seconds 15 seconds 15 seconds
Precision approach Category I	Approach lighting system Runway edge Visual approach slope indicators Runway threshold Runway end Essential taxiway Obstacle	15 seconds 15 seconds 15 seconds 15 seconds 15 seconds 15 seconds 15 seconds
Precision approach Category II/III	Approach lighting system Supplementary app. lighting barrettes Obstacle Runway edge Runway threshold Runway end Runway centre line Runway touchdown zone All stop bars Essential taxiway	15 seconds 1 second 15 seconds 15 seconds 1 second 1 second 1 second 1 second 1 second 15 seconds
Take-off RWY for RVR < 800 m	Runway edge Runway end Runway centre line All stop bars Essential taxiway Obstacle	15 seconds 1 second 1 second 1 second 15 seconds 15 seconds

- rotational standby sources - diesel generators:
 - with manual start – up within 2 minutes
 - with automatic start -within 15 seconds
 - short-break -within 1 second
 - no-break -uninterrupted power supply.

Static standby sources:

- battery short-break -within 1 second
- battery no-break -uninterrupted power supply.

Diesel generators with manual start–up within 2 minutes are used in smaller aerodromes with a non-instrument or an instrument runway. On larger aerodromes, they may be used for the provision of supplies of electrical energy to individual facilities such as the lighting of buildings, lifts, and the like. In general, they provide outputs up to 2.5 MVA.

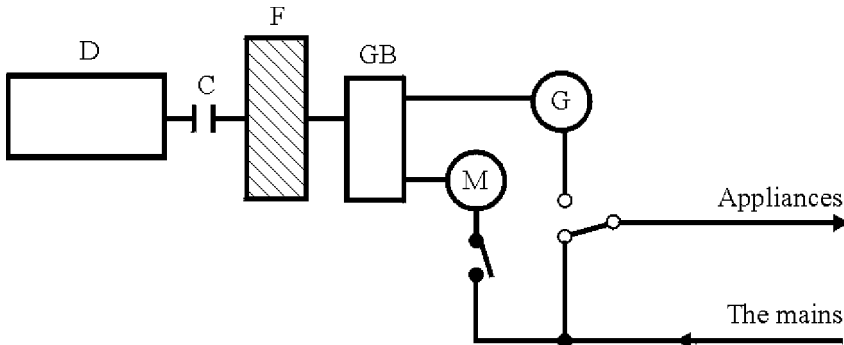

Figure 16-1 Short-break diesel generator

D – diesel generator, C – clutch, F – flywheel, GB – gearbox, M – motor, G - alternator

Diesel generators with automatic start within 15 seconds are connected with an automatic control box which monitors the parameters of the electrical network. When the specified voltage and frequency parameters of the network drop under the determined limit, the automatics will start the diesel generator and switch the supply over to the standby source. If the first start is unsuccessful, the automatics will repeat the start procedure after several seconds. Diesel generators with automatic start are used not only as separate equipment, but also in combination with battery or other back-up sources (see below), where a battery or different source of energy provides an immediate back-up of electrical energy in the event of a failure of the network, and after starting, the diesel generator will recharge the system.

In the 'classic' systems a short-break diesel generator (Figure 16-1) has a heavy flywheel, which is driven at a constant speed through a gearbox by an electric motor supplied from the mains. An alternator, which in the normal state of the network runs with no load, is on one side of the flywheel shaft. On the other side of the shaft, there is a diesel generator connected by means of an electromagnetic clutch. When the monitored parameters of the electric network drop under the determined values, the diesel generator is automatically started and connected by means of the electromagnetic clutch to the flywheel and alternator. While the diesel generator reaches its full power, the alternator is driven by the turning flywheel. At the same time the automatics switch the appliances over to the alternator terminals. In the event of a failure of electrical energy, there is a short-term voltage drop of about 10%, and a frequency drop of about 4%.

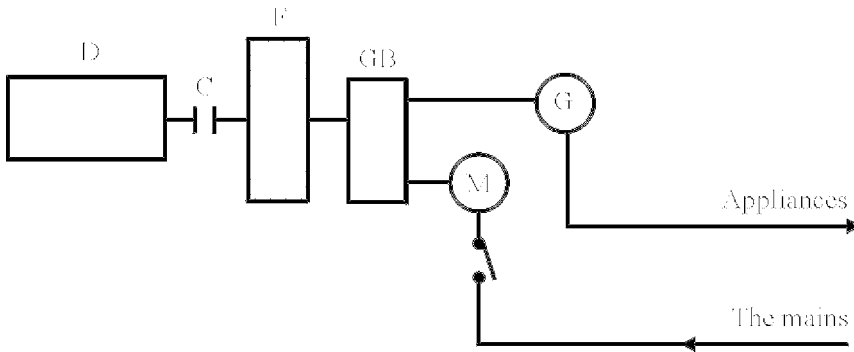

Figure 16-2 Not-break diesel generator

D – diesel generator, C – clutch, F – flywheel, GB – gearbox, M – motor, G – alternator

The no-break diesel generator – or Uninterruptible Power Supply (UPS) (Figure 16-2) is used when no short-time electric current failure is permitted, for example in a supply of current for any of computer systems or secondary radar. The no-break equipment differs from the previous type in that the electric motor constantly drives not only the flywheel, but also the alternator, from which electricity is supplied to appliances. In the event of an interruption of the mains supply, there will be only a very short-term voltage and frequency drop.

The traditional short-break and no-break equipment is expensive to purchase and to operate. This is not only due to requirements to provide a high reliability of the system, but also due to the need for high power inputs for the lighting systems of higher categories of landing aids. Some firms supply equipment that may be used differently according to meteorological conditions, normally as a diesel generator with automatic start, and when meteorological conditions drop under the determined limits, it may be switched over to short-break and no-break modes.

A different approach is represented by the NZ² system offered by the Caterpillar company. The immediate power back-up is provided by a high energy-density integrated flywheel-motor-generator unit to store power (Figure 16-3). It is called Kinetic Power Cell Technology. The 273 kg heavy flywheel rotates vertically on a ceramic bearing in a vacuum chamber and is magnetically lifted to unload the flywheel bearings. When the flywheel reaches 4 000 RPM it is fully functional and capable of supporting the load during a power outage. The full charge of the flywheel is at 7 700 RPM. Total time to complete the start-up sequence to full charge status is less than 5 minutes. The UPS system is nearly maintenance free. It needs just basic maintenance, diagnostics and the bearing cartridge replacement approximately every three years [38].

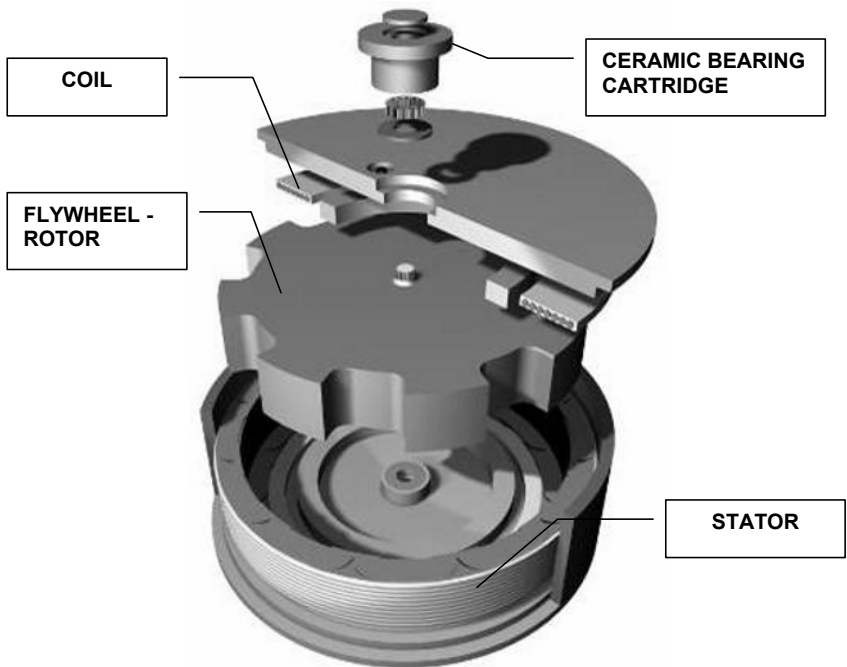

Figure 16-3 *Integrated flywheel-motor-generator unit*
(Source: Courtesy Phoenix Zeppelin Ltd.)

Power from the Caterpillar's UPS with Kinetic Power Cell Technology is immediately available up to a critical load. The UPS provides only 15 seconds of backup time, but this is enough for start up and connecting a diesel-generator which can take the full load. The system has very high energy efficiency, between 96 to 97 per cent. It is much more environmentally friendly compared to the battery based systems. The NZ² system is delivered in a 6 m long steel container.

Static or battery-based UPS systems are more common than any other alternative UPS system.

They work by storing power in a string of batteries. When power from the utility is abnormal, power is pulled from the battery string. After the energy supply returns to normal, the batteries are recharged in anticipation of the next event [38]. Battery based UPSs are typically used for low capacities and immediate back-up of computers, communication equipment or navigation aids with low energy consumption. The endurance required before the diesel generator starts (if necessary) may vary from several minutes up to several hours. Modern batteries with a closed cycle can have a high service life up to 10 years, and high capacity with small dimensions. Usually the small UPSs are installed as close as possible to the appliance but it is also possible to centralise supply for the systems with a fall-out not longer than 1 second to a single transformer station. The battery strings must be housed in a separate room that must be well ventilated. Most common valve-regulated lead acid (VRLA) battery-based systems have extensive maintenance needs. Regular inspection, terminal cleaning, tightening of connections and voltage measurements are crucial. In addition, several tests must be done to determine battery performance levels [37]. Battery back up systems work with 86 to 93 per cent energy efficiency.

In spite of the fact that the static standby sources are used mostly for appliances with low consumption sometimes they are still used as sources with very high outputs for a short time. A static standby source may be designed as short-break but usually as no-break – UPS, according to how it is connected (see Figure 16-4). The capacity of the high output battery systems is typically designed to be able to work 15 minutes under full load. After that it is supposed that the back-up is provided by diesel generators which also recharge batteries.

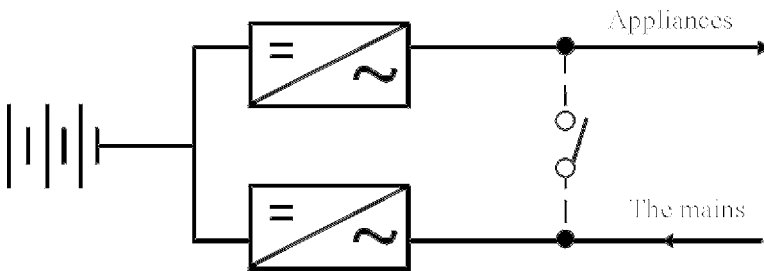

Figure 16-4 Static standby source; no-break – full line, short-break – dashed line

Some types of batteries used in UPS systems are more reliable than others but they are still considered to be the weak link in backup power sources. In fact, 70 per cent of all UPS problems are directly related to their batteries [39]. The main problem is that even with repeated load testing, there is no satisfactory evidence that the battery system will survive next full load discharge.

16.3 SUPPLY SYSTEMS

The supply of lighting systems may be provided in two ways, namely by parallel or serial distribution systems.

16.3.1 Parallel System

The well-established parallel distribution system (Figure 16-5) is used at present for small lighting systems. It uses a constant voltage source. A three-core cable is connected to the switchboard of the transformer station equipped with a stepping control transformer for reducing voltage. Every individual light is connected to cable conductors by means of the isolating transformer. An advantage of the parallel distribution system is its simplicity.

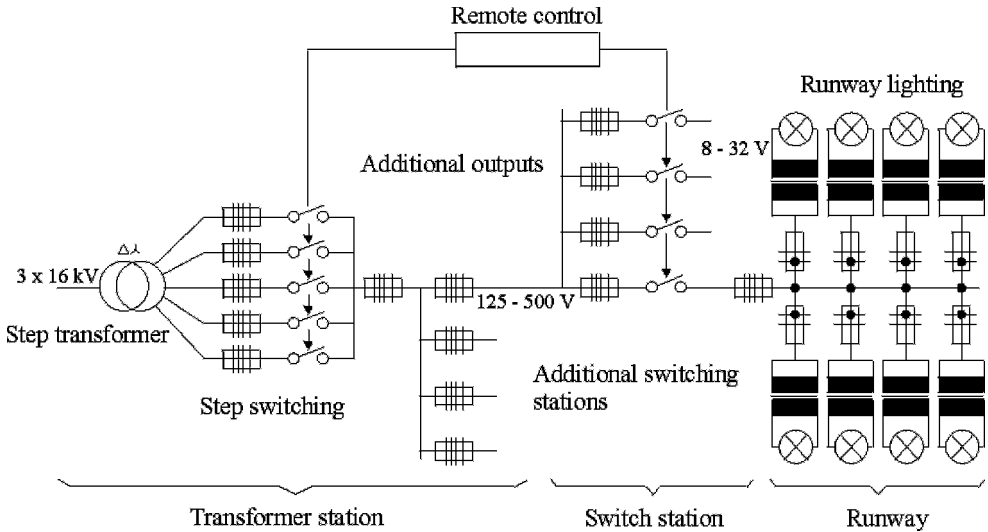

Figure 16-5 Parallel distribution system - principle

The maintenance personnel need not be qualified for work with high voltage. The current in halogen lamps of the parallel distribution system is not regulated. As the tungsten gradually settles on the lamp filament, the lamp resistance drops and the current in the lamp increases, the tungsten melts, evaporates, and the lamp acquires its initial parameters. These lamps give a constant light during their whole service life. The main disadvantage of the parallel distribution system is that the voltage drops with distance from the transformer station, and thereby also the intensity of the more distant lights drop. For that reason, the parallel distribution system is only suitable for small areas, such as the lighting systems of heliports or aprons.

16.3.2 Serial System

16.3.2.1 Serial System – the Principle

The serial distribution system (Figure 16-6) is now almost universally adopted for runway lighting systems. Contrary to the parallel distribution system, which is supplied with constant voltage, the serial distribution system operates with constant current. It consists of a closed loop of single-core cable. Isolating transformers are put into the circuit, which ensure that there will not be a break of the primary circuit when the secondary circuit is interrupted (lamp bulb failure) and that the remaining lights continue to operate.

16.3.2.2 Serial System – Components

The distribution cable, the quality and reliability of particular components, and the quality of installation all contribute to the reliability of the lighting systems. The components of a serial distribution system are:

- single-core high voltage supply cables
- high voltage connectors
- two-core low voltage cable
- low voltage connectors
- isolation transformers
- contact boxes
- constant current regulators
- system of control and monitoring of the lighting systems.

The number of elements in a lighting system increases with the airport category. Therefore for lighting systems of higher categories, components of higher quality should be used in order to avoid a loss of reliability of the whole system. The system of a Category II or III runway includes up to 100 km of single-core high voltage cables, approximately 1 000 isolation transformers, 2 000 high voltage connectors, and a large number of low voltage connectors.

High voltage cables are normally single-core cables with a copper core with a cross section of 6 mm. They are designed for an operating voltage from 500 to 5 000 V. The usual range of operating voltages is 500, 600, 750, 1200, 3000, 5000 V. The cables are unshielded at the lower

voltages. Shielded cables limit the interference caused by the thyristor regulation of the constant current regulators. Cables can be made in exact lengths, and equipped with standard connectors while in the production plant. Cable is more often supplied on drums, and connectors are mounted on site at the aerodrome. If the connectors are made in the production plant, the final mounting of the lighting system can be completed more quickly.

Advantages of a cable system with connectors mounted in the aerodrome are:

- simplification of design works
- simpler production
- savings of up to 10% of cable length
- easier installation when cable ducts and transformer shafts are used, since the required lengths may be provided with a centimetre precision.

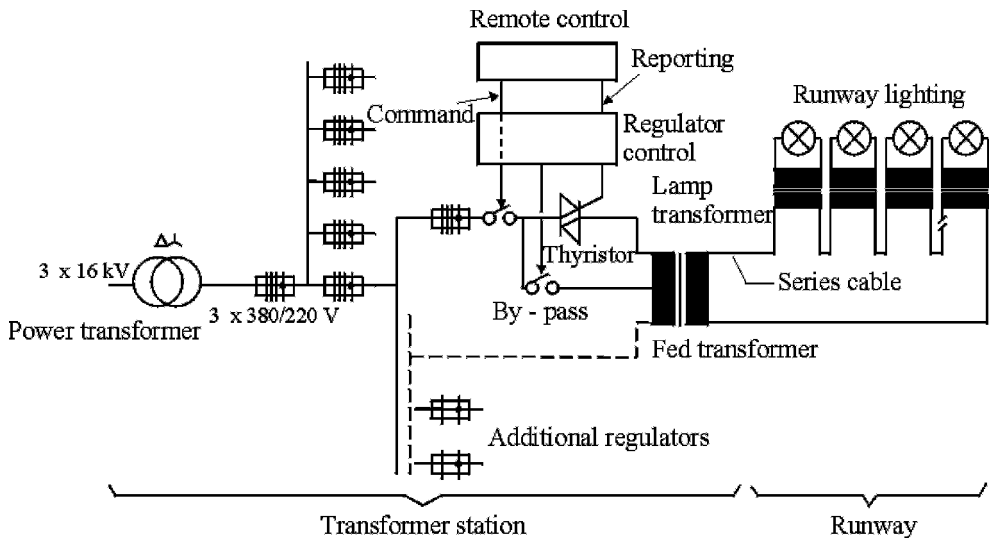

Figure 16-6 *Serial distribution system - principle*

Current is fed from the isolation transformer to the lights via low voltage (LV) cables. The LV cables are equipped with standard FAA connectors. In the event of the light failing, the connector is severed, and the light disconnected from the cable. If the light is distant from the isolation transformer, an extending LV cable (flexo) is used. This is a two-core LV cable equipped with a standard termination and FAA socket. LV cables are designed for a voltage of 250 or 600 V, while the operating voltages are usually between 6 and 45 V.

The isolation transformers are enclosed in rubber or plastic material, which ensures that they remain water-tight. The isolation transformer is provided with two high voltage (HV) leads for connecting two power cables and one LV lead for connecting to a light. The transformer output range is 30, 45, 65, 100, 150, 200 a 300 VA. The HV leads are designed for a voltage of 5000 V, the LV lead for a voltage of 250 or 600 V.

The serial lighting systems are fed from constant current regulators. These are power supply transformers with control and monitoring circuits. The control of the intensity of the lights is most often in five steps that are 1%, 3%, 10%, 30%, 100% of light intensity. In some systems, such as PAPI and taxiway side lights, the light intensity is controlled in three steps of 10%, 30% a 100%. The seven steps control, with 80% light intensity, is used only occasionally. That setting ensures high light intensity, and does not reduce the service life of the light sources. The monitoring system provides information about the condition of the constant current regulators in terms of condition of the loop's insulation and the number of failed lights to indicate the need for maintenance of the lighting systems and to alert the air traffic controllers. The constant current regulators are placed in transformer stations and supplied from LV switchboards. Connector boxes, which allow several circuits of the lighting systems to be connected to a single constant current regulator, are also part of the supply system.

The constant current regulator maintains constant current of a specific value throughout the whole circuit despite a varying load, caused, for example, by burnt-out filaments in the lamps. The constant current regulators usually have an output range of 4, 8, 16, and 32 kVA. In more advanced lighting systems, which have a lower power demand, the power output range is usually 2.5, 7, 7.5, 10, 15, 20 and 25 kVA, though power outputs over 15 kVA are rarely used. In the power input loop of 15 kVA, a power cable with an operating voltage not higher than 3000 V may be used. Output current of constant current regulators is usually either 6.6 A or, more rarely, 8.3 A at the maximum intensity of the lights. At lower degrees of light intensity, the output current is proportionally lower.

A constant current regulator must indicate certain conditions:

- operation status
- failure
- insulation condition of the loop
- number of failed lamps
- degree of light intensity in the loop.

A clock records the number of hours the loop operates at a maximum light intensity and the total number of hours of operation. In simple systems, the constant current regulators usually indicate only operation, failure, and insulation condition of the loop.

The constant current regulators are equipped with over-current and over-voltage protection, which automatically disconnect them so that the lights cannot burn out if the power supply cable or separation transformers are damaged. An electric charge may be induced in the long loops of the lighting systems when lightning strikes near the lights during a storm, which may damage the constant current regulators. Therefore the loops are connected with the constant current regulators by means of a lightning arrester. Another possible solution is the installation of a strong non-insulated and grounded conductor in the ground over the power cables.

In some cases it is convenient to supply several circuits of the lighting systems from a single constant current regulator, for example two PAPI systems, a few STOP lighting bars, various sections of taxiway inset lights etc. Connector boxes placed beyond the constant current regulators, or in modern lighting systems, directly built into the constant current regulators, serve for switching of the specific loops. The boxes are equipped with HV connectors. On the basis of instructions from the control tower, the particular circuits are connected according to the requirements and pre-determined algorithms. For example, the runway centre line inset lights are connected to two circuits. Only one of them is always switched on, according to the runway that is in use. The runway centre line inset lights are lit only in the direction either of landing or of take-off. The PAPI systems are similarly supplied from constant current regulators for both directions of landing. In the case of taxiways, the connector boxes operate in a different way. According to the instructions from the control tower, one, two and even more circuits whose lights may be lit simultaneously are connected. A typical example may be supplying two STOP-bar lights from a single constant current regulator.

Modern constant current regulators are controlled by a microprocessor. The microprocessor regulates and monitors all the conditions and protections of a regulator. A more reliable and simpler communication system is also provided between a constant current regulator and the control and monitoring system, including an unambiguous identification of a failure of the regulator indicated in the office of the maintenance manager. The system of A-SMGCS is discussed in Chapters 15 and 17.

In order that the reliability may be improved, the lighting system supply is provided by a whole range of circuits. Depending on the number of insulation transformers in the loop, their power input, and HV cable length, the power input of the constant current regulator may be determined. The biggest load is usually in the loops of an approach system of high light intensity, and in the loops of runway edge lights. Every such loop supplies from 60 to 100 lights with a power input of

150 to 200 W, and the loop power input may reach up to 20 kVA. Small lighting systems, e.g. STOP-bar lights, PAPI and simple approach lighting systems require relatively small power input. The power input of the lights, including losses in the separation transformers, is given in Table 16-2.

The losses in the cable reach approximately 200 W per 1 km of the cable length. The calculation of the power input of the loop of an approach system of high light intensity is given in the following example.

Example – power input of the loop:

$$P = A \times B + L \times Z = 65 \times 177 + 3,2 \times 200 = 12\,145 \text{ VA}$$

where:

- P – power input of the loop
- A – number of lights (65 pcs)
- B – power input of the light (177 VA)
- L – cable length (3.2 km)
- Z – loss in the cable (200 W.km⁻¹)

In this case, the calculation shows that the load from the lights is decisive, while the losses in the cable are of little importance.

Table 16-2 Power inputs of the lights

Light bulb [W]	Power input [VA]
45	56
65	77
100	118
150	177
200	230
300	354

16.4 ELECTRICAL SUPPLY TO CATEGORY I - III LIGHTING SYSTEMS

The lighting system of an aerodrome contains a whole range of systems which should be reliably supplied and controlled. Each aerodrome has its specific features. The electrical supply for a lighting system of low or middle light intensity of a non-categorised aerodrome is usually simpler, and contains from 2 to 8 constant current regulators. On the other hand, Category II and III systems are provided with a more extensive supply system containing a greater number of constant current regulators. For a Category II aerodrome, the usual number of constant current regulators is 15 to 25 in one transformer station. The electrical supply to the extensive taxiway systems in Category III is very complicated. The centre line guidance in a runway with inset lights is divided into a whole range of separately fed sections, requiring a large number of constant current regulators and connector boxes. For example, Munich airport, equipped with the lighting systems for Category III, is divided into 1 200 separately supplied circuits.

17

RADIO NAVIGATION AIDS

Tony Kazda and Bob Caves

17.1 BACKGROUND

The pioneering stage of radio navigation can be traced back to the 1930s when the radio direction finders (RDF) and the LORENZ systems (the name of the factory) ultra-short-wave landing equipment were developed and used in Germany in military operations for the first time. The LF/MF radio range system has served the US civil airways since about 1931, and a network of hundreds of stations covered all parts of the nation [146].

Today most commercial flights are carried on under Instrument Flight Rules (IFR) even in good weather conditions. Many airline companies have strict rules that all their flights must be IFR operated. However, visual reference is necessary for the final approach and landing in most cases.

Thus radio navigation aids create a complex integrated system with visual aids and electric supply systems to allow regular and safe air transport operations. Radio navigation aids are also referred to as non-visual aids. The required performance of the non-visual aids varies with the category of runway at which it is used. There is a wide range of equipment and facilities which could be divided into two main groups:

- radio navigation aids
- radars and radar based systems.

The system is complemented by voice communication systems of moving and fixed radio communication networks. In this chapter an outline of equipment and facilities related with the airport operation is presented.

The technical requirements and characteristics of non-visual aids are specified primarily by the Annex 10 – Aeronautical Telecommunications, Volume I – Radio Navigation Aids and Volume IV – Surveillance Radar and Collision Avoidance Systems.

The installations and locations of particular navigation aids and systems are usually specified on the basis of the regional air navigation agreements which are valid for a period of at least 5 years. The non-visual aids used for approaches, landings and departures and for the terminal area and aerodrome surveillance and control are the following:

- Instrument Landing System (ILS)
- Microwave Landing System (MLS)
- Global Navigation Satellite System (GNSS)
- VHF Omnidirectional Radio Range (VOR)
- Non-Directional Radio Beacon (NDB);
- UHF Distance Measuring Equipment (DME)
- Transponder Landing System (TLS)
- Precision Approach Radar (PAR)
- Surveillance Radar Element (SRE)
- Surface Movement Radar (SMR).
- Advanced Surface Movement, Guidance and Control Systems (A-SMGCS)

GNSS, VOR, NDB, DME AND SRE are used also as en-route navigation facilities.

17.2 RADIO NAVIGATION AIDS

17.2.1 Instrument Landing System (ILS)

The first ILS tests started in 1929 in the UK and six systems were installed and certified by CAA in 1941 [140]. The first ICAO certified system using army standards was adopted in 1949. In the 1960s the first ILS equipment for ‘blind’ landings was approved. The system principles remained unchanged until today [144].

Each ILS system comprises the following components:

- VHF localizer (LLZ)
- UHF glide path (GP)
- VHF marker beacons.

All three parts are equipped with monitoring systems, remote control and indicator equipment.



Figure 17-1 The ILS LLZ 21 element antenna - Hanover International Airport

(Source: Wikipedia, http://en.wikipedia.org/wiki/Image:EDDV-ILS_27R_Localizer.jpg, 7.1.07)

The *localizer* antenna is a massive and large-scale construction to guarantee the emitting characteristics (Figure 17-1). It is located typically between 300 m – 600 m behind the runway end. The distance must ensure that the antenna construction lies below the take-off obstruction clearance surface (see Chapter 3). The minimum distance behind the runway end is 300m to satisfy the Runway End Safety Areas requirements (see Chapter 5). The housing for LLZ transmitters is usually located 100–120 metres to the side of the aerial. The LLZ antenna must be positioned on the extension of the runway centre line.

The VHF localizer operates in the band from 108 MHz to 111.975 MHz. The localizer and glide-slope frequencies are paired in accordance with Annex 10, Volume V specifications and only the localizer frequency needs to be tuned in the aircraft. For example, every localizer operating at

110.3 MHz has a glide slope operating at 335.0 MHz. If the localiser is equipped with a DME, it is also paired.

The LLZ antenna emits two horizontally polarized beams in the shape of a ‘lobe’. When approaching the runway, the carrier frequency on the right side ‘lobe’ is modulated by a 150 Hz tone and in the ‘lobe’ on the left side 90 Hz frequency modulation is predominant (Figure 17-2).

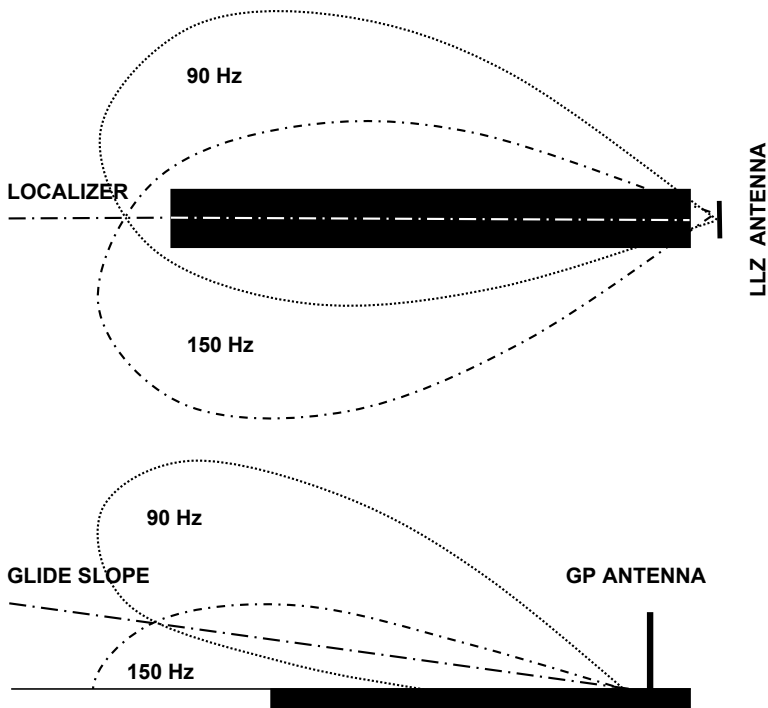

Figure 17-2 *The radiation pattern of the localizer and glide slope antennas*

(Source: Instrument Landing System Operational Notes, Dept. of Aviation, CAS Australia)

The receiver in the aircraft determines the Difference in the Depth of Modulation (DDM) between the 90 Hz and 150 Hz signals. On the course line, i.e. the extended runway centre line, there is a locus of points of equal 90 – 150 Hz modulation. The localizer signal coverage must be sufficient for a typical aircraft avionics installation. It must extend from the antenna centre to the distance of [178]:

- 46.3 km (25 NM) within $\pm 10^\circ$ from the centerline
- 31.5 km (17 NM) between $\pm 10^\circ$ and $\pm 35^\circ$ from the centerline

→ 18.5 km (10 NM) outside $\pm 35^\circ$ if coverage is provided.

The localizer signals must be receivable vertically within the specified coverage at and above the 600m height above the threshold elevation or 300m above the elevation of the highest point within the final approach areas, whichever is higher. The upper limit is defined by a 7° inclined surface.

Depending on the ILS performance Category, there are strict minimum field strength signal requirements and other signal quality parameter specifications within the localizer coverage. To guarantee the signal quality in mountainous or in broken terrain, special two-frequency systems could be used. The coverage can be further improved by an LLZ antenna with higher number of elements.

The *glide path* antenna is typically located 225 – 380 metres from the runway threshold and 120 – 210 metres to the side of the runway centreline, usually on the side where the interference from passing aircraft is smaller (see Figure 3-4, page 53). The glide slope signals are partially formed by reflection from a steel grid on the ground in front of the GP antenna. The UHF glide path operates in the band from 328.6 MHz to 335.4 MHz. Also a GP transmitter emits modulated signals with the 150 Hz tone predominating below the path and the 90 Hz tone above the path. The glide path equipment should be adjustable by 1° above or below the standard approach angle of 3° . Within $\pm 8^\circ$ from the centerline the signal coverage must be guaranteed to a distance of at least 18.5 km (10 NM).

The *marker beacons* operate on the frequency of 75 MHz and radiate a fan shaped field pattern vertically upwards. There are usually two marker beacons installed (middle marker and outer marker) or, if it is required by the procedures, a third – inner marker, can be added. The marker beacons are installed in defined positions on the approach where pilot could check the correct height of the aircraft.

The outer marker (OM) is located typically 7.2km (3.9 NM) from the threshold, except when it is not practicable, in which case it must be placed between 6.5 and 11.1 km (3.5 and 6 NM) from the threshold. The outer marker modulation is 400 Hz and it transmits two dashes per second continuously. The purpose of the OM is to provide height, distance and equipment functioning checks to aircraft on intermediate and final approach.

The middle marker (MM) should be located 1 050 m (3 500 ft) or ± 150 m (500 ft) from the threshold. The middle marker modulation is 1 300 Hz and it transmits alternate dots and dashes. The purpose of the MM is to indicate the imminence, in low visibility conditions, of visual approach guidance.

Figure 17-3 Reflections at the glide path antenna

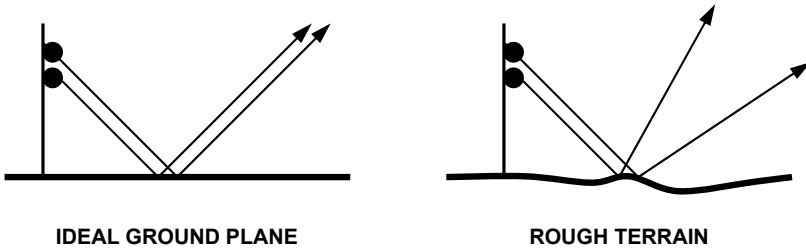

(Source: Forssell, B.: Radionavigation systems)

The inner marker (IM), if installed, is located between 75 m (250 ft) and 450 m (1 500 ft) from the threshold. The inner marker modulation is 3 000 Hz and it transmits continuously at six dots per second. The purpose of the IM is to indicate in low visibility conditions the imminence of arrival at the runway threshold. The IM location is in the point of the lowest decision height for the Category II minima.

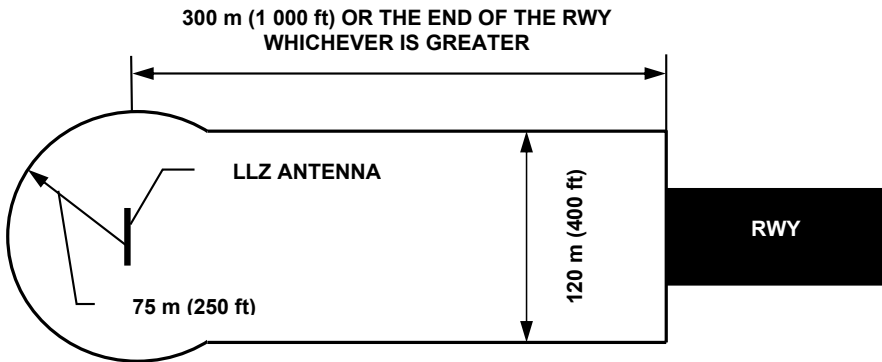

Figure 17-4 The LZZ critical area

(Source: ICAO Annex 10 Aeronautical Telecommunications, Volume I)

To guarantee the quality of the ILS signals, the terrain around the localiser and glide path antennas must be perfectly level without depressions or uphill slopes (Figure 17-3). In winter the area must be cleared of big snow deposits which may cause signal distortions. During Category II or III operations, ILS critical and sensitive areas must be kept free and protected at the airport.

The localizer critical area dimensions depend on the LLZ position with respect to the runway end (Figure 17-4). The sensitive areas are larger and depend on the ILS/runway Category, the type of LLZ antenna and the critical aircraft which uses the runway under the low visibility conditions.

17.2.2 Microwave Landing System (MLS)

A Microwave Landing System (MLS) is a precision approach and landing guidance system. It was originally designed as a replacement of ILS after 2010. The first version of MLS was developed and tested in Australia at the end of 1970s. The version called Interscan was approved in the USA by the FAA in 1975 and three years later also by ICAO. MLS has many advantages compared to ILS.

MLS can operate on 200 channels in the frequency spectrum from 5 031.0 MHz to 5 090.7 MHz, comparing with only 40 channels in case of ILS. The antenna is typically located 300m behind the runway end but it does not need to be installed in a specific position at an airport. MLS antennas are much smaller and lighter due to the shorter wavelength of the frequency spectrum.

In its basic configuration the system has five functions:

- approach azimuth
- back azimuth
- approach elevation
- range
- data communications.

All MLS signals, except the DME, are transmitted on a single frequency only through time sharing. The MLS beam scans across the coverage area at a fixed time rate and both azimuth and elevation data can be calculated by an airborne receiver which measures the time interval between scans.

The system is very resistant to any type of interference by fixed or moving objects or snow accumulations. The signals are more stable than in the case of ILS. MLS does not need protection of large sensitive and critical areas. It is hardly disturbed by aircraft in flight or when taxiing on the ground. Because of this the aircraft separation on approach during low visibility operations can be smaller, resulting in higher runway capacity during these conditions. Also the accuracy of MLS is much higher than with ILS.

However, the system was not taken up quickly enough. By the 1980s MLS was installed experimentally in only a few locations. For the airline companies it would have been necessary to install MLS in addition to ILS avionics if flying to those few airports equipped with MLS systems. In 1994 USA decided to terminate further MLS testing in favour of the GPS which should supplement or replace existing MLS systems. Phasing down of MLS systems in the USA is planned to begin in 2010 [141].

Because of specific weather conditions in the United Kingdom with a high percentage of Category III operations and frequency congestion in the core London area, the UK decided to proceed to MLS implementation without relying on GNSS systems [121]. MLS is operated at Heathrow airport in parallel with ILS. There are specific separation procedures to allow smooth operations for aircraft equipped with ILS or with MLS to increase the runway capacity during Category II and III conditions.

17.2.3 Global Navigation Satellite System (GNSS)

There are several global navigation satellite systems under construction or in a development or testing phase. However, at the beginning of 2007 only one was fully functional – the U.S. Global Positioning System (GPS). The GPS was developed, funded and is controlled by the U.S. Department of Defence.

The basic operating principle of all satellite systems is simple and is the same. The crucial element is an atomic clock measuring time very accurately. Each satellite sends out personalised signals indicating the precise time when the signal left the satellite. The receiver station is able to distinguish a particular satellite and from the time delay between transmission and reception of each GPS radio signal it calculates the distance to each satellite. To fix the receiver's position simultaneous signals from at least four satellites must be received (Figure 17-5).

Even though there are many thousands of civil users of GPS world-wide, the system was designed for and is operated by the U.S. military. GPS fulfils the civil aviation performance criteria specified in ICAO Annex 10, Aeronautical Telecommunications, Volume I, Radio Navigation Aids for basic navigation, initial approach procedures and non-precision approaches. However, for the precision approach performance criteria specified for the system accuracy, integrity and time to alert, continuity and availability, it is necessary to improve the accuracy parameters of the system. For example, in the ground based systems like ILS or MLS, the emitted signals can be easily monitored and the response to the transmitter status is immediate. There is no such way of rapidly warning the GPS user of a 'standard' GPS failure. The most promising satellite based navigation system, with high positional accuracy of at least 7.6 m, is the Wide Area Augmentation System (WAAS) where the satellite constellation is complemented by a Ground Segment of multiple Wide-area Reference Stations (WRS) and the Spaces Segment with geosynchronous communication satellites [189] to fulfil civil aviation user needs. The system was developed by the FAA and the U.S. Department of Transportation.

Figure 17-5 From the time delay the distance from satellites and the position is calculated

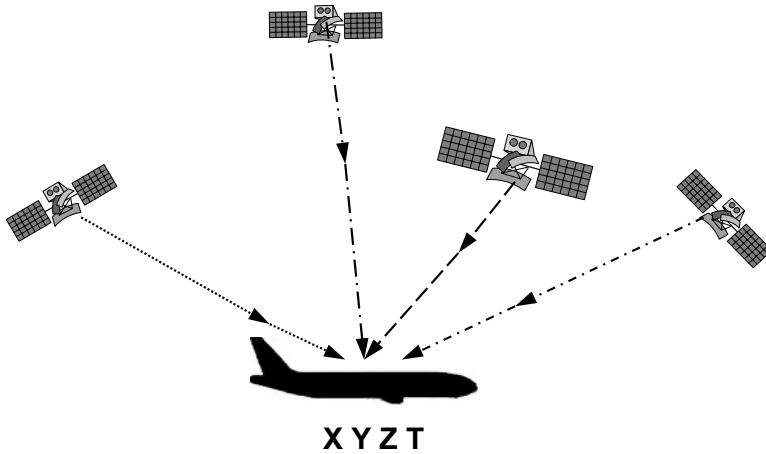

The new Galileo satellite navigation system which is being built by the European Union should meet all requirements for the civil aviation systems. The system should be operational after 2010.

17.2.4 VHF Omnidirectional Radio Range (VOR)

VHF omnidirectional radio range (VOR) was developed and internationally standardised in 1949 to provide safe navigation coverage over the 360° azimuth. The frequency spectrum, between 108.0 – 117.95 MHz with 50 kHz channel separation, ensures that the signal is practically insensitive to atmospheric disturbances. VOR has much higher accuracy and reliability than, for example, NDB. However, the range is limited to the line-of-sight, therefore the transmitters are usually located on elevated ground or mountain tops. The biggest advantage of the system is that VOR defines exactly each 'radial' from the facility. If it is coupled with DME it clearly and simply specifies the position fix.

The standard VOR transmitter antenna generates a composed radiation pattern consisting of a non-directional and a figure-of-eight pattern in the same manner as in the direction finders [122]. The resulting cardioid pattern is electronically rotated thirty times a second. The second signal is transmitted by a non-directional antenna. It is amplitude modulated by a sub-carrier of 9 960 Hz, which is frequency modulated by 30 Hz. On top of that the signal is amplitude modulated by a Morse code for the station identification.

Figure 17-6 *D-VOR/DME ground station Nitra*



(Photo: A. Novák)

When the signal is received in the aircraft, the FM signal is demodulated from the sub carrier and the frequency is extracted. A measurement of the phase difference between the two 30 Hz signals gives an unambiguous direction from the transmitter to the aircraft. It is shown in degrees from the local magnetic north, and is called the ‘radial’. If the VOR position information on a particular radial is combined with the distance data from the DME, the airplane flight management system can create a ‘virtual’ glide slope for a precision approach.

The receiver error is mainly the result of signal reflections close to the transmitter. In Doppler VOR the 30Hz amplitude modulated signal is transmitted by a reference antenna. The antenna is formed from a large number (40-50) of antennae mounted in a ring around a reference antenna. The amplitude modulated 9 960 Hz signal is sequentially switched to the elements to create a rotating signal (Figure 17-6).

17.2.5 Non-directional Radio Beacon (NDB)

A Non – Directional radio Beacon (NDB) is in principle a simple radio transmitter which radiates a signal equally in every direction (hence 'non-directional') in the band 190 - 1750 kHz. The signal is modulated with a Morse code for identification. In most countries the NDB station is identified by a three, two or one-letter Morse code. NDB is very old and inaccurate radio – navigation equipment with many disadvantages. The NDB signals are affected by atmospheric conditions, rough terrain, mountain ridges, coast line refractions, night effects and electrical storms.

Figure 17-7 NDB identification NIT (Nitra)



(Photo: A Novák)

However, an NDB has at least three advantages over the more sophisticated VOR. It is cheap, it is very simple and, as a result of the frequency band used, the NDB signals can follow the earth's curvature, hence the signals can be received at greater distances and at lower altitudes. Practical range in the frequency band 200 - 400 kHz is about 300 km over the mainland and about 500 km over the sea.

The NDB antenna system consists of a horizontal antenna fixed on masts of 20 – 60 m height. The antenna length controls the transmitter's frequency. For reliable operation, it is necessary to locate

the transmitter on terrain which is flat up to 150 m from the NDB. No obstacles, in particular electric lines or metal constructions, are allowed in the transmitter's vicinity.

At the airports, NDBs are used for non-precision approaches (2 NDB approach to define the approach direction) where the NDBs determine the approach direction and also serve as a fix on the approach for the height check. In precision approaches they are usually co-located with the markers.

17.2.6 Distance Measuring Equipment (DME)

Distance measuring equipment (DME) provides pilots with distance information between the aircraft and the location of the DME ground equipment. The DME is a navigation aid which can measure the distance from an aircraft to a ground reference point. It can serve more than one aircraft simultaneously. Most DME installations are co-located with VOR equipment. VOR provides the directional information and together with DME distance they specify the exact position, i.e. they give the 'aircraft fix'.

The basic principle of DME is to measure the time of a pulse sent by the aircraft's DME interrogator, which is then detected by the DME transponder and sent back. The aircraft's equipment detects the pulse sent by the transponder and measures the time difference t (μs) between the first pulse sent and the received pulse.

The DME operates in a frequency band from 962 to 1213 MHz. The channel spacing is 1 MHz. Each channel has its own number from 1 to 126. The frequency of the DME equipment depends on the co-location with a particular VOR/DME-station. The practical DME range varies from 10 to 20 NM at an altitude of 25 000 ft up to 100 NM or even more if the aircraft altitude is 50 000 ft.

Every aircraft which has DME equipment (interrogator) sends interrogation pulses at the receiving frequency of the DME station. These pulses are detected in the ground station and the DME transponder is activated. The coded reply-pulses are sent back with a fixed 'Reply Delay' on a sending frequency separated by 63 MHz to the given interrogation frequency. All pulses appear in the form of pulse pairs with a fixed Pulse Pair Spacing. The fixed Reply Delay is introduced to give an aircraft flying nearby a chance to transmit all pulse pairs before receiving the corresponding reply pulses.

The ground stations also transmit Morse identification code on the 1 350 Hz modulated frequency which is in an aircraft heard as a dot-dash signal.

17.2.7 Transponder Landing System (TLS)

Transponder Landing System (TLS) is a new landing aid certified by the FAA up to Category I precision landing limits. It was developed by the U.S. ANPC - Advanced Navigation & Positioning Corporation as an alternative system for airports with low IFR traffic volumes.

From the pilot's viewpoint, the TLS works like a conventional ILS and the same ILS instruments are used for the aircraft position indication. In the TLS system the ground stations interrogate the aircraft's transponder. The aircraft's position is determined by measuring the arrival time and angle of radio signals transmitted from the aircraft's secondary radar transponder. The range of the TLS is typically 22 NM in a sector of 45° to either side of the runway centreline but the system could be also used for 360° airfield surveillance.

During the approach the inbound aircraft is identified by the standard four-digit transponder code and a track is established for guidance purposes. At an update rate of 10 Hz, the system compares the aircraft's location with its 'correct' one and calculates the differences. The 'correct position' data are transmitted to the aircraft by VHF localizer and UHF glide slope signals modulated with 90 and 150 Hz tones as in the ILS systems.

The system can track 25 aircraft (or equipped ground vehicles as a way to prevent runway incursion accidents) but only one aircraft could be 'on the beam' at a time, because the TLS generates a correction based on its position [146]. It is difficult to estimate the TLS prospects relative to the FAA programme of Wide Area Augmentation System (WAAS).

17.3 RADAR SYSTEMS

17.3.1 Precision Approach Radar (PAR)

Precision Approach Radar (PAR) is the only 'passive' system with precision approach capabilities. The pilot during approach must fully rely on the instructions from the air traffic controller who monitors the aircraft position on the two screens displaying the azimuth and elevation situation. The PAR specifications are still included in the ICAO Annex 10, Aeronautical Telecommunications, Volume I, Radio Navigation Aids. However, because of the very high operational costs of the equipment and the requirements for air traffic controllers and pilots qualifications update the system is practically not used in the civil aviation. The Ground Controlled Approach (GCA) is used mostly in military operations.

17.3.2 Surveillance Radar Element (SRE)

Initial development of radar systems can be traced back to as early as the beginning of 20th century. However, the first functional systems were not brought into operation until World War II.

The basic principle of the primary radar is that the radar waves reflected back from objects in the air or on the ground are captured on the radar antenna, processed and shown on the radar screen as a target. The size of the target on the screen depends, besides radar technical characteristics, on the aircraft size, type and location of the propulsion units, type of materials used in the aircraft construction, type of paint used and the target distance from the radar.

There are many different radar types and many different applications. At airports and in airport terminal areas, radars are used for monitoring aircraft and ground vehicles and controlling them to increase capacity, expedite traffic and increase safety especially during low visibility operations.

Surveillance Radar Element (SRE) must be able to detect an effective aircraft echoing area of 15 m² at a range of at least 46 km for. For this purpose, radars with a wave length of 3 cm are used. The radar installation point must guarantee perfect 'vision' over the full 360° of azimuth.

17.3.3 Surface Movement Radar (SMR)

Surface Movement Radars (SMR) are mainly used for aerodrome movement area surveillance and control especially during low visibility conditions or at night. For this purpose, millimetre wave radars with aperture antenna are used. They are usually located on the highest point, e.g. on the aerodrome tower, as their vision is limited to the line-of-sight. To complement the SMR picture in the 'blind areas' behind buildings, automatic cameras or millimetre wave sensors are sometimes used.

17.3.4 Advanced Surface Movement and Guidance Control Systems (A-SMGCS)

It is difficult to know where it would be most appropriate to place a description of the Advanced Surface Movement, Guidance and Control Systems (A-SMGCS), because usually it is a combination of visual, electronic, radio-navigation and radar aids.

All aerodromes have some form of Surface Movement, Guidance and Control Systems (SMGCS). The simplest ones are just painted guidelines and signs. The more advanced and complex include switched taxiway centre lines and stop bars (see Chapter 15, 15.2.5).

The main benefits from the implementation of A-SMGCS are associated with, but not limited to, low visibility surface operations. The significant differences between the functions of a SMGCS and an A-SMGCS are that the latter should provide more precise guidance, surveillance and control of aircraft and vehicles on the movement area, and should also be able to ensure spacing between all moving aircraft and vehicles especially in Low Visibility Conditions when spacing could not be maintained visually (Figure 17-8).



Figure 17-8 *During low visibility conditions it is not possible to maintain aerodrome ground control visually (Photo: A. Kazda)*

Typically the base functions of A-SMGCS should allow:

- surveillance
- control
- routing
- guidance
- conflict alert.

There are different sub-systems used to provide A-SMGCS functions to aircraft and vehicles. They can be based on the surface movement radars, mode S implementation, millimetre wave sensors, induction loops, optical sensors or combination of all these devices.

A-SMGCS is usually used at airports with high throughput where it would be difficult or even impossible to maintain surveillance and control on the movement areas with conventional surface movement radar (SMR). A-SMGCS should provide situational awareness not only to air traffic controllers but also to those aircraft and vehicles that can come into proximity with each other. A-SMGCS also reduces voice communication, improves the usage of surface guidance aids and increases reliance on avionics in the cockpit to help guide the pilot to and from the runway.

The technical standards for an A-SMGCS are recognized to be the most demanding for the most critical conditions in terms of traffic density, visibility conditions and aerodrome layout. Implementation of facilities and procedures to these levels will, therefore, be not appropriate at all aerodromes.

An A-SMGCS needs to be related to the operational conditions under which it is intended that the aerodrome should operate. A failure to provide a system appropriate to the demands placed on an aerodrome will lead to a reduced movement rate or may affect safety.

It is important to recognize that complex systems are required and are economically viable only at aerodromes where visibility conditions, complexity of aerodrome movement areas, traffic density and any combination of these factors present a problem for the ground movement of aircraft and vehicles.

17.4 FLIGHT INSPECTIONS AND CALIBRATIONS 1

Any air navigation system, from the time of its installation up to its decommissioning, is subject to extensive tests and inspections. While the word ‘test’ is used when one or more parameters are measured with appropriate reference equipment, ‘inspection’ refers to a series of tests carried out by a State or by an organisation on behalf of the State. The output of a test is data and the output of an inspection is a statement as to whether the inspected system is functional or not. Depending on the testing methods there are two basic sets of test: ground and flight tests or inspections. Ground tests or ground inspections can be carried out only in the close proximity of the navigation facility and the system has to pass successfully a series of specified ground tests providing signals in space of required quality.

¹ The authors acknowledge the kind help received from Ivan Ferencz from the Navigation Division of the Slovak CAA in the preparation of this section.

Air navigation facilities are critical for the safety of civil aviation and it is not enough just to ‘assume’ that a system is safe. There is no room for compromises when testing reliability, accuracy or integrity of radio-navigation equipment or systems. Therefore in most states the flight inspections of navigation facilities are carried out by an organisation under the State’s responsibility. They are usually performed by a dedicated flight inspection unit designated to issue a facility Status Classification based on flight inspection results.



Figure 17-9 *Flight inspection aircraft with measuring systems*
(Photo: J. Šulc)

There are usually three elements of a flight inspection unit: aircraft, measuring systems and crew. Each of these elements has to comply with special requirements. The flight inspection aircraft is usually a twin engined turboprop or jet with endurance of at least 3 hours, a wide range of speeds including the capability to fly at 105 knots or less, with suitable vertical climb speed and ample of space on board for measuring systems’ installations. There are many different antennas installed on the top and bottom of the aircraft’s fuselage.

Flight inspection systems are permanently or temporarily installed on board of aircraft and consist

of sets of sensors, position reference systems, data processing units and human-machine interfaces. The range of sensors depends on the tasks performed by a particular aircraft. There are usually VOR/ILS, MKR and ADF receivers, SSR transponders, VHF transceivers or GNSS receivers complemented with spectrum analysers and oscilloscopes. Position reference provides autonomous information about the aircraft's position in the space. For this purpose additional ground equipment is usually used. The required aircraft positional accuracy depends on the inspected system. Generally, it should be five times higher than the tolerances of the measured parameter. Typical position reference systems are GNSS with or without augmentation and with phase tracking capability, theodolite, laser or infrared tracker with telemetry uplink between the ground station and the aircraft.

The positioning systems can be also combined with an inertial reference system. This can further enhance the accuracy or continuity of positional information. Data from sensors and position reference systems are processed in a data processing unit which is running on a real-time computer. Where required, outputs of sensors are compared with reference data to specify ground equipment or a system's differences or errors. The results are presented in graphical or alphanumeric form to the flight inspection engineer who operates the system. Flight inspection crew consists of two pilots, one or two engineers and, when necessary, a ground reference systems operator. Because of special flight inspection procedures and a much higher workload on the test pilots, the crew must have special training and in some states also additional pilot's qualifications. Despite the flight inspection systems being highly sophisticated and most of data being generated automatically, the flight inspection engineer must take into consideration specific limitations of sensors, performance of position reference systems, weather conditions during the flight and many other factors. The final decision whether the system is operational or not is the responsibility of the flight inspection engineer who declares the facility status.

18

AIRPORT WINTER OPERATION

Tony Kazda and Bob Caves

18.1 SNOW AND AIRCRAFT OPERATION

Snow means pleasure for children but it is also the source of problems for airport administrators. The obligation to maintain a clear surface of the runway and other movement surfaces of the airport has been imposed upon the airport operator by Annex 14, Volume I. Contamination of the movement areas, which include e.g. snow and ice, means limiting or closing an airport's operation. Icing on the aircraft and its dispersal may decrease utilisation and disruption of the flight schedule.

This results in loss of revenue for the airports and airlines and also in costs connected with clearing the snow and ice. Each airport has to:

- provide an effective snow plan
- provide regularity of flight operation in the winter despite adverse meteorological conditions.

When clearing ice by chemical means, the negative impact of chemical substances on the environment must be minimised.

A layer of snow on the runway surface causes:

- resistance acting on the aircraft's wheels during the take-off run; the magnitude depending on the density and thickness of the snow layer, characteristics of the aircraft undercarriage, and

the speed and weight of the aircraft

- increase of drag and decrease of lift of the aircraft during the take-off run due to snow being thrown up from the wheels, particularly the nose wheel
- decrease of braking effect from the runway surface friction, particularly when the contamination is ice, increasing the possibility of exceeding the available distances for landing or rejected takeoff.

Icing on the aircraft, particularly on the lifting surfaces, changes the aerodynamic characteristics and flight performance, and it can block or impair flight controls and increase the weight of the aircraft. Iced sensors can cause the pilot to receive wrong information about speed or engine condition. Therefore before take-off all the ice has to be removed.

The effect of contamination on the movement areas of the airport on the aircraft operation depends on several factors, in particular:

- air temperature
- runway temperature
- specific density of snow.

The higher the air temperature the higher is also the specific weight of the snow. Three kinds of snow have been defined according to its specific weight, and slush which is not a snow but a mixture of water and ice crystals:

Dry snow: Snow which can be blown if loose or, if compacted by hand, will fall apart again upon release. Specific weight of dry snow is up to but not including 350 kg.m^{-3} .

Wet snow: Snow which, if compacted by hand, will stick together and tend to form a snowball. Specific weight from 350 kg.m^{-3} up to but not including 500 kg.m^{-3} .

Compacted snow: Snow which has been compressed into a solid mass resisting further compression and which will hold together or break up into lumps if picked up. Specific weight of compacted snow is above 500 kg.m^{-3} .

Slush Water-saturated snow which, with a heel-and-toe slapdown motion against the ground, will be displaced with a splatter. Specific weight of slush is from 500 kg.m^{-3} up to 800 kg.m^{-3} .

The easiest way to ascertain the specific weight is by taking a sample of a certain volume of snow and dissolving it. The higher the specific weight of snow or slush the higher is the resistance acting on the aircraft's wheels. A layer of slush on the runway of approximately 4 mm is enough to affect the performance of an aircraft, and if the slush layer is above 13 mm the runway has to be

closed and cleared. For comparison the runway must be closed if a layer of dry snow is 5 cm thick.

18.2 SNOW PLAN

The snow, slush or ice must be removed from the movement areas of the airport quickly and without residues in order to ensure safe operation of aircraft. Economic factors must also be considered. The snow plan of an airport should specify the organisation, the provision of airport equipment and the necessary chemicals, and co-ordination of work with air traffic control. The possible scope of a winter plan is given in Airport Services Manual, Part 2 Pavement Surface Conditions, Chapter 7 Snow removal and Ice Control (ICAO Doc 9137-AN/898).

Preparation of the whole airport for the winter is very important. It includes not only full preparation of equipment, training of new workers and retraining of full time personnel, but also the maintenance of the movement areas. The basic requirement is that the airport and all equipment must be in perfect condition sufficiently in advance of the possible appearance of adverse weather conditions. The training of workers, who will perform the winter maintenance should include:

- ➔ Radiotelephonic procedures. The workers must have necessary qualifications for operation of the radio station; they must be familiar with the operation of the given type of transmitter and know the radio phraseology.
- ➔ Procedures for removing of snow and ice. The procedures are different for each kind of snow and the runways in use.
- ➔ Operation of equipment. Each worker must control properly the assigned technical equipment in any weather by day or night without affecting safety of operation.
- ➔ Airport. The workers must know perfectly the layout of all parts of the movement areas of the airport even during night or low visibility conditions.

Many workers from various departments of the airport participate in the winter maintenance and it is necessary to co-ordinate their work. The snow co-ordination committee controlling individual activities of winter maintenance will include airport management, meteorological services, air traffic controllers and representatives of airlines.

When preparing the snow plan it is necessary to consider a number of factors such as topography, climatic conditions, airport location, types of aircraft that use the airport, density of operations and physical characteristics of airport movement areas.

Priorities for clearing snow and ice from various parts of movement areas have been specified in

Annex 14, Volume I, Chapter 10 and they must also be entered in the winter plan. They can be changed, but only after an agreement between the airport operator and air traffic control. Priorities for clearing movement areas are as follows [179]:

- runway(s) in use
- taxiways serving the runway(s) in use
- apron
- holding bays
- other areas.

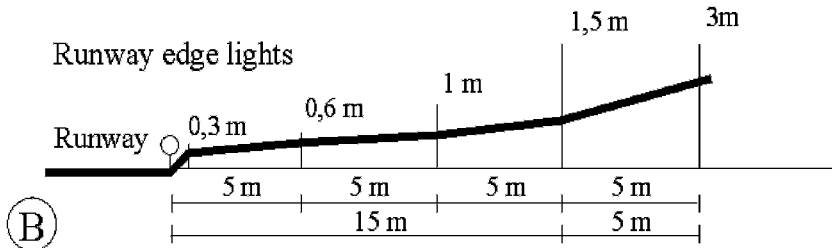
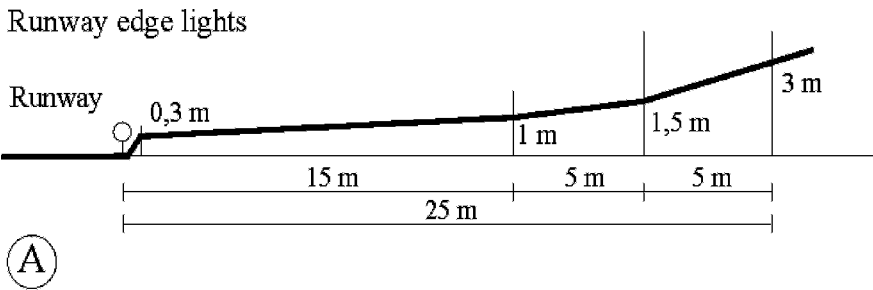

Figure 18-1 Maximum height of snowbanks

A – Runways used by very large aircraft (such as B-747, DC-10, L-1011)

B – Runways used by other than very large aircraft

(Source: Airport Service Manual, Part 2 Pavement Surface conditions)

In addition to the above areas, attention has to be paid to clearing snow from the vicinity of antennas, radio navigation equipment, and particularly from the vicinity of the glide path ILS antenna, the signal of which is very sensitive and could be distorted by the layer of snow. Depending on weather conditions and operational possibilities, other movement areas and access roads will also gradually be cleared as the opportunity arises.

Because snow is hygroscopic, its weight can grow quickly when the temperature is around zero. When clearing of snow is being planned, it is necessary to take account of this property. Therefore with the fall of the first snow flakes, clearing of snow should already be started on the most important areas. Usually it is still possible to allow a few more aircraft movements before the runway will have to be closed and the centre of the runway be cleared. The procedure used for the first clearing of the runway depends on the equipment which is available, the kind of snow (dry, wet, compacted or slush) speed and direction of the wind and other factors. Which of the runways shall be cleared will usually be specified by the airport duty manager in co-operation with air traffic control on the basis of a meteorological forecast. If critical snowbanks are not formed (see Figure 18-1) it will be possible to open the airport for operations within a relatively short time. If snow continues to fall, further closure and clearing of the runway become necessary. It is no use clearing the runway during a snowstorm; the snow will be blown onto the runway as fast as it is being removed. After the snowstorm is over, and the airport has to be opened as quickly as possible, the personnel are tired and the equipment needs replenishing and inspection. If two runways are available and if this is made possible by the meteorological conditions, it is advantageous to open one runway and continue to clear snow from the other.

It is not economically realistic to maintain a sufficient quantity of equipment to cope with the worst predicted weather. Therefore, if those extreme conditions occur, the airport will have to be closed.

The aircraft operators are informed about the up-to-date condition of the airport or its closure by SNOWTAMs, which are distributed by means of the AFTN telex network (Figure 18-2).

If the airport has only one runway, it is often necessary to use equipment which enables the snow to be cleared at high speed. For other areas with lower priority it is possible to use normal procedures of clearing snow and ice, or less used areas can be temporarily closed.

Although keeping the aerodrome movement areas open has the highest priority, it is necessary to ensure that the airside and landside roads and parking places are available in order to ensure transportation to and from the airport. It is sensible to contract-out the clearance of such areas e.g. by agricultural companies or by construction companies, since their equipment is little used in the winter.

In order to remove snow and ice from the movement areas it is possible to use mechanical, chemical or thermal means.

18.3 MECHANICAL EQUIPMENT FOR SNOW REMOVAL AND ICE CONTROL

Mechanical equipment for snow and ice clearing from the runway surface should always, whenever possible, be preferred. Its primary advantages, in comparison to chemical and thermal means, are lower costs and negligible environmental impact. Mechanical equipment is used mostly for snow clearing. There is little that can be done mechanically to treat a layer of ice but, under certain conditions, it is possible to improve the braking action by sanding the ice layer.

The speed and quality of snow clearing from movement areas of the airport depends to a great extent on the number and capacity of the equipment. When selecting the equipment the airport operator must consider a number of factors:

- scope of operation
- capital and operating cost of the equipment
- dimensions of airport areas
- availability of spare parts and possibility of repairs
- climatic conditions.

At small airports with general aviation operations or with only a few scheduled traffic movements a day, it may be best to outsource snow clearing. Alternatively, if it snows only occasionally, it is possible to close the airport for a few hours or even days.

Airport manoeuvring areas have different physical characteristics from roads, so they require special equipment, which enables faster and higher quality clearing of the runway surfaces. The airport area is flat and the runways are wide. In the runway there are usually inset lights protruding above the surface of the runway. The terrain behind the runway edge lights, which is often not paved, must also be cleared. The snow layer on the airport runway is usually not deep, but the time for clearing the runway must be substantially shorter than for roads. All these are characteristics which have to be considered when selecting the mechanical snow removal equipment.

The number of pieces of equipment for winter service can be specified on the basis of the average height of snow cover, amount of snow falling within one snowfall, area of the movement surfaces which are to be cleared, and the type and intensity of the air operations. It is usually not worthwhile to equip airports having a total snowfall below 40 cm a year and up to 5 cm of snow in one snowfall with a great number of expensive and high performance pieces of winter service equipment and vehicles.

The snow accumulated at the edge of the runway must be removed. Snow blowers are normally used for this. The performance of the snow blower is a critical parameter in the fleet of winter service equipment and vehicles, and it is also the most expensive equipment. At some airports in temperate climates and only a small layer of snow cover a year, it is sometimes possible to use a special type of plough which removes snow at high speed, rather than a snow blower (Figure 18-3). The use of such a plough has to be considered separately for each case, because several other factors have to be taken into account.

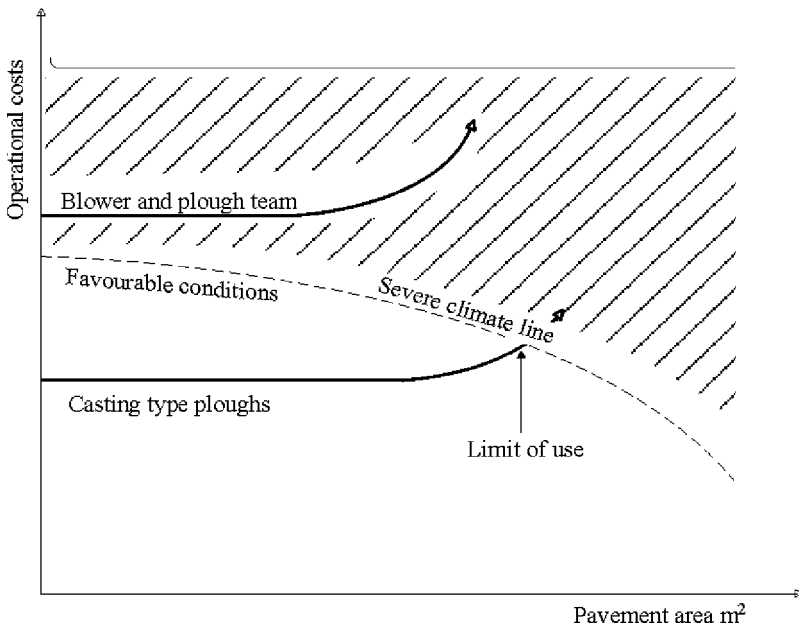

Figure 18-3 Casting type ploughs

(Source: *Airport Services Manual, Part 2 Pavement Surface conditions*)

Other winter service vehicles and equipment which are used on larger airports are air blower machines, ploughs, sand/aggregate trucks, chemical spreaders, tankers and loaders.

When removing small layers of snow it is best to use air blower machines to sweep the snow, since they will clean the surface of the runway properly. The height of the rotary brush above the surface of the runway is electronically controlled so as to clean the runway thoroughly without the brush being excessively worn.

There are many types of special ploughs for airport use. The widest are wider than any of the road ploughs, at 4.5 m and more. The blade portion of some airport ploughs has been divided into several sections, each of them being separately spring or hydraulically loaded. If it contacts an

obstacle, e.g. an inset light, the appropriate section will lift. Modern blades are produced of light composite carbon materials, which have three main advantages. They are substantially lighter than the common blades made of steel, their friction coefficient with the surface of the runway is low and they do not corrode. The low weight of the blade and low friction coefficient contribute to decrease fuel consumption. However, special winter maintenance equipment despite of having higher productivity is also more expensive and its purchase at smaller airports with moderate traffic must be carefully considered (Figure 18-4).

An airport with regular air transportation should be equipped with one or more high performance snow blowers, which are capable of throwing snow with a specific weight of 400 kg.m^{-3} a distance of at least 30 m. On airports with regular commercial transport, there should be sufficient equipment to ensure removal of a 2.5 cm snowfall from the main runway and from two most used taxiways connecting the main runway with the apron. On the basis of operational experience, clearing the taxiways requires approximately 25% more time than clearing a runway of comparable area.

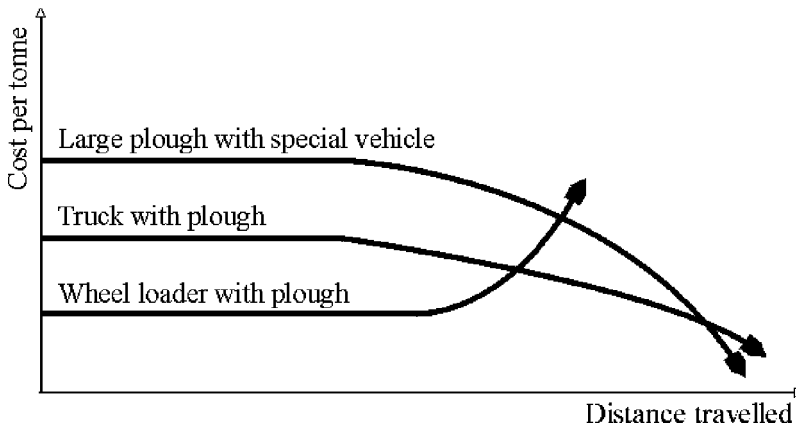

Figure 18-4 Ploughing costs/distance

(Source: Airport Services Manual, Part 2 Pavement Surface conditions)

According to Airport Services Manual, Part 2 Pavement Surface conditions a 2.5 cm thick layer of snow should be removed from the main runway and from the two taxiways within the following time limits with the stated number of air transport movements (atm):

- 40 000 and more atm, the snow should be removed within 30 minutes
- 10 000 to 40 000 atm, the snow should be removed within one hour
- 6 000 to 10 000 atm, the snow should be removed within two hours

→ 6 000 and less atm, the snow should be removed within two hours, where possible.

Two ploughs should be included into the work group in front of each snow blower, the performance of which should correspond to the performance of the snow blower. It is necessary to close one runway system for only 20 minutes at Munich.

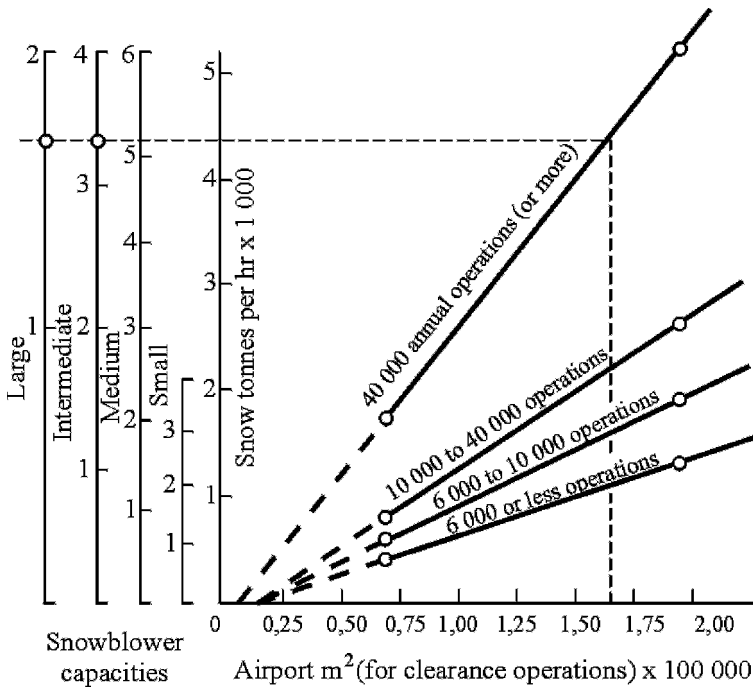

Figure 18-5 *Snow blower selection card*

(Source: *Airport Services Manual, Part 2 Pavement Surface conditions*)

Similarly the equipment for a general aviation airport, which mostly serves aircraft up to 5 700 kg, vehicles and equipment for winter operations should ensure the removal of 2.5 cm snow layer from one runway, taxiway connecting the runway with the apron and from 20% of the apron. The airport should be equipped by one snow blower capable of throwing snow of a specific weight 400 kg.m^{-3} at least 15 m. The snow layer 2.5 cm thick must be removed as follows:

- 40 000 and more movements a year, the snow should be removed within two hours
- 6 000 to 40 000 movements a year the snow should be removed within four hours
- 6 000 and less movements a year the snow should be removed within four hours, where it is possible.

The airport should be equipped with at least one plough with the performance equal to that of the

blower. A higher value than 2.5 cm must be used at airports with extreme weather conditions as the critical height of snow conditions, the value corresponding to the real climatic conditions.

One airport with extreme weather conditions is Magadan airport. It is located in the valley of the river Uptar 30 km from the Sea of Okhotsk in the monsoon area. The average annual temperature of air is + 6.6 °C. The month with the lowest average temperature is January, with – 24 °C. The absolute minimum is – 46 °C. The snow cover persists on average 210 days a year. The average number of days without frost is 68 days. The average height of snow cover created in the course of 10 days is 54 cm.



Figure 18-6 *Snow blower is usually the most expensive winter equipment*
(Photo: Courtesy Bratislava M.R. Štefánik Airport)

The performance of winter service vehicles and equipment must match the total volume of snow which needs to be removed from the movement areas. Because each airport has a set time for snow removal according to its position in the appropriate group and the reference height of snow cover of 2.5 cm has also been fixed, the area of the movement areas from which the snow is to be removed is the determinant of the capacity of winter service vehicles and equipment. The relationship is linear, as shown in Figure 18-5. The required performance of other vehicles and equipment can be determined in a similar way to the performance of the snow blower (Figure 18-6).

For the example given in the Table 18-1 the performance of the snow blower must be at least 4,400 t of snow per hour. The performance data of snow blowers given by the producers must be considered as approximate and in most cases they are optimistic. The performance must be verified by a practical test under the real conditions in the airport unless references can be obtained from other airport operators. In practice, the capacity of the snow blower can be 40 to 50% lower than the given capacity.

The performance of other equipment must be higher than the performance of the snow blower. Their selection is affected by the same factors as the selection of the snow blower.

Table 18-1 Determination of snow blower capacity

1. Pavement area to be cleared		
Main runway	3 000 x 45 m	135 000 m ²
Parallel taxiway with connectors	3 000 x 23 m	69 000 m ²
Two connector taxiway	400 x 23 m	9 200 m ²
Holding areas	2 x 40 x 60 m	4 800 m ²
Apron	25% of 16 000 m ²	4 000 m ²
Total area to be cleared		222 000 m ²

2. Other parameters		
Snow removal time (1 st group of airports)		30 min. - 4 ° C
Temperature		400 kg.m ⁻³
Snow density		2.5 cm
Depth of snow		

3. Determination of snow blower capacity		
Snow volume	222 00 x 0.025	5 550 m ³
Snow mass	5 500 x 400	2 200 000 kg
Snow blower capacity per hr		4 400 000 kg
Snow blower capacity per hr in tonnes		4 400 t

In some countries the use of sand is permitted to improve braking action on the runway. However, a small grain of sand can damage an engine blade if sucked into it, so sand should be used as the

last resort when it is not possible to use other chemical or mechanical means to remove the ice. Therefore sand is used primarily at very low temperatures, when the use of chemicals is not effective. The kind of sand must be carefully checked. Fine sand which can fall through a sieve with 0.297 mm mesh does not guarantee the required improvement in braking, and it can be easily blown away by the wind from the surface of the runway. Coarse material, which does not get through a sieve with 4.76 mm mesh can damage the jet engine blades and it also damages the leading edges of propeller blades. Individual sand particles must be sufficiently hard to resist the shear forces upon braking, but soft enough to minimise the damage of the metal surface of the aircraft structure. The sand must not contain small rocks, impurities, salts and other corrosive substances. The most suitable material is crushed limestone with knife-edges.

In order to increase braking action significantly and at the same time to minimise the possibility of sucking the sand into the engine, individual grains of sand must be embedded into the surface of the runway. This is possible only if the temperatures are well below zero. The possible manners of embedding the sand are:

- heating the sand before distributing it
- melting the ice sprinkled with sand by burners
- spraying water on ice sprinkled with sand.

After the grains of sand have been embedded into the ice, for which several tens of minutes are necessary, free grains of sand must be swept away and vacuum cleaned. The runway has to be cleaned in the same way after a thaw.

18.4 CHEMICALS FOR RUNWAY DE-ICING

Chemicals used for removing ice or for the prevention of icing on the surface of the runway must meet a number of requirements, which are often conflicting. They must be cheap and effective. They must damage neither the aircraft structure nor the runway. They must not be toxic and their harmful effects on the environment must be minimal. After de-icing chemicals are applied, a thin layer of water is formed over the remaining sheet of ice. Such a surface is the most slippery possible and the braking action is practically zero. The time necessary for completely dissolving the ice depends not only on the kind and concentration of the chemical but also on the meteorological conditions, thermal condition of the runway and the thickness of the ice layer.

Chlorides cannot be used for de-icing of airport movement areas because of corrosion, although they are cheap and effective. Sodium chloride may be used mixed with crushed gravel for access roads in some countries. If it is applied in its solid state and particularly if applied liberally,

sodium chloride damages the pavement surface.

One of the most used chemicals at the airports is urea. The technical term urea is used for the amid of the carbonic acid – carbamid with chemical composition $\text{CO}(\text{NH}_2)_2$. Urea is a non-toxic substance, and its shelf life is unlimited.

The theoretical efficiency of urea is high up to $-11.5\text{ }^\circ\text{C}$, the eutectic temperature, at 24.5% concentration of the solution. Practically it is possible to use urea up to $-5\text{ }^\circ\text{C}$. Its advantage is that it can be applied as a de-icing or as a preventive anti-icing chemical. Urea can be applied in the form of a solution, preferably warm, or by sprinkling granules. Sprinkling can be performed dry or the granules can be mixed with water and sprayed. Before application of urea as a de-icing fluid, it is necessary to clean the runway as much as possible by mechanical equipment. The spraying will take effect about 30 to 60 minutes after application. After the ice has softened it is necessary to complete the cleaning of the runway mechanically.

Table 18-2 Recommended concentrations of urea

Urea application	Urea solution [l m ⁻²]	Urea granules [g.m ⁻²]
Preventive	0.05 – 0.1	15 – 20
De-icing	0.15 – 0.35	30 - 70

It is better to use urea as a preventive chemical in a 35% solution, which is safe against recrystallising up to $-8\text{ }^\circ\text{C}$. When used in this way for anti-icing, the urea concentrations are lower, as shown in Table 18-2. This results not only in lower costs but also in smaller impact on the environment, as discussed later.

Higher doses of urea for de-icing pose a greater threat to the surface of the runway. This is particularly so for concrete surfaces. After the ice layer has been sprinkled with urea granules, a system with two components – **k** ($\text{CO}(\text{NH}_2)_2$ and H_2O) in three phases – **f** (urea, ice and water solution) will be formed, as shown in Figure18-7.

According to Gibb's phase rule, which determines the degree of freedom of system **v**, i.e. number of dimensions determining the condition of the system (temperature, pressure and composition), this is a monovariant system, i.e. the degree of freedom is only one according to the equation:

$$v = k + 2 - f$$

where:

- v number of degrees of freedom
- k number of components
- f number of phases.

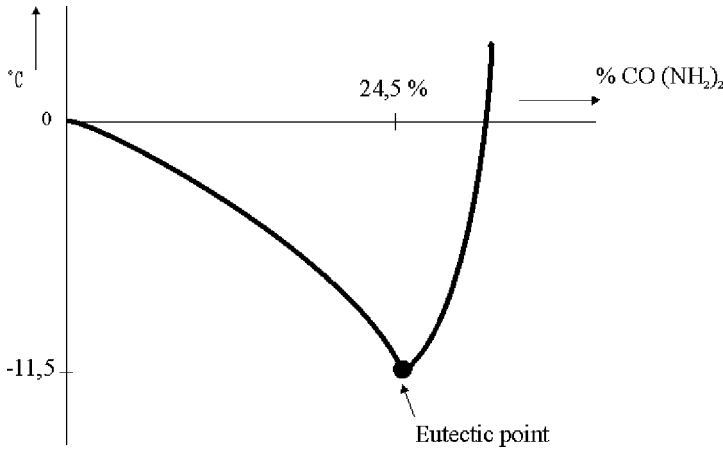

Figure 18-7 Ice - urea de-icing system

The magnitude of the degree of freedom is the same as the degree of freedom of a eutectic mix. This means that under the given pressure and temperature this system is not in balance. Therefore the ice will start thawing and its temperature as well as the temperature of the runway surface will suddenly drop as a result of the consumption of the latent heat of thawing. In the growing water volume, more urea will be thawed. This will continue to happen until the temperature of the mix decreases to the eutectic temperature. Of course, with a concentration of urea less than eutectic, the achieved temperature will be higher. This process leads to rapid cooling of the runway surface and to large differences in temperature inside the upper layer of the concrete slab. This results in high internal tensions, which cause peeling of the top 3 to 5 mm of the concrete runway. If urea is applied in a warm solution the necessary thermal energy will partially be taken from the solution and the surface of the runway is not so stressed as in granular application.

This peeling occurs particularly with new rigid runways, the surface of which is absorptive. At temperatures slightly below zero the water in capillary pores of the runway surface is not frozen. The rapid cool down as a result of application of the urea causes the water in the capillaries to freeze and this causes a further increase of stress in the surface layer of the runway. Therefore before winter, new runways have to be impregnated with a protective coating, which reduces the penetration of water into the surface.

Urea was originally used as a fertiliser. Nitrogen accounts for about 45% of the total weight of urea. Application of urea increases the concentration of nitrates in ground and surface waters. There is then significant growth of algae in the watercourses and this disrupts the ecosystem, particularly where it is not possible to achieve sufficient dilution when the waste waters are discharged. Therefore the use of urea is forbidden or limited in some airports. The concentration of nitrates is often monitored in several parts of the drainage system of the airport and in outlets into watercourses. Limiting values of contamination of waste waters of NH_4 max. $3.5 \text{ mg} \cdot \text{l}^{-1}$, NO_3 max. $15.0 \text{ mg} \cdot \text{l}^{-1}$ and dissolved materials $300 \text{ mg} \cdot \text{l}^{-1}$ should be met when checked three to five hours after application of de-icing chemicals on the airport.

In order not to exceed the appropriate limits of nitrate concentration in surface waters, retention pools have been built on some airports, in which contaminated waters are trapped and then gradually and slowly discharged. Alternative solutions are the construction of a water treatment plant or the combination of both solutions. The volume of waste waters from two runways at Munich airport is so large that the considerable capacity of a water treatment plant would not be utilised in the periods when the ice is not melted. Therefore two retention pools have been built on the airport. The underground tank has a volume of $60\,000 \text{ m}^3$ and the surface pool has a volume of $20\,000 \text{ m}^3$. Water from retention pools is admitted into a water treatment plant in Eitting in precisely specified volumes depending on the concentration, where it is treated together with municipal sewage.

The use of urea must therefore be always considered according to the local conditions. If its use is unsuitable, it is possible to use more expensive but environmentally friendly acetate-based chemicals.

Airport operators are now rejecting traditional chemicals in favour of those based on acetates. These are more effective at lower temperatures, they act for longer, they leave a less slippery surface, their storage is easier, they are non-toxic and do not damage the environment. Potassium acetate-based de-icing fluids are theoretically effective up to the temperature of $-60 \text{ }^\circ\text{C}$. In fact they have just one disadvantage – a high price.

Acetate-based chemicals are recommended by the environmental authorities in the USA, in several countries of Western Europe and in Scandinavia. They are easily biodegradable with a small consumption of free oxygen in water. When they decompose, carbon dioxide and water are generated. They are, however, more expensive than the more traditional de-icers. It is probable that for those airports that have already built expensive facilities for the waste water treatment from movement areas of the airport or retention pools as at Manchester, it will be more advantageous to carry on using urea or glycol, which are cheaper in comparison to the acetates. Because acetates have lower viscosity, they require different spraying devices than e.g. glycol, which means another

additional investment for many airports. Therefore each airport must consider the advantages and disadvantages of individual chemicals in its specific situation.

Potassium acetate-based chemicals are used in solution for anti-icing. For runway de-icing it is better to use a combination of granules of sodium acetate and a solution of potassium acetate. The granules of sodium acetate are applied first. As the granules dissolve, heat is released and this creates holes in the ice. At the moment the solution of potassium acetate is applied, it will penetrate through the holes to the surface of the runway, where it acts from below and releases the ice from the surface of the runway.

Glycol-based de-icing chemicals have two disadvantages. Ethylene glycol and diethylene glycol are toxic. Moreover, ethylene glycol is considered to be carcinogenic. This can be overcome by using propylene glycol-based chemicals, which is considered non-toxic in many countries. Despite this, glycol is used on its own or in combination with urea because of its easy manipulation, storage and the price.

The disadvantage of all kinds of glycol is that upon decomposition in the water they consume a high volume of oxygen and this seriously endangers life in the watercourse. Therefore waste waters must be treated before being discharged into the watercourse. On Munich airport, glycol-based de-icing chemicals are used for taxiway de-icing. Treatment of waste waters and disposal of glycol is performed directly in special beds made of bentonite powder and sand built along the taxiways through which the waste waters seep. Bacteria are inoculated into the beds, which decompose glycol into water and carbon dioxide.

Ice can also be removed from a runway with high pressure water. The Küppel-Weisel company offers this technology. The water is sprayed under high pressure through nozzles against the runway. It penetrates through the layer of compacted snow or ice, disturbs it and separates it from the surface of the runway. Then the runway is mechanically cleaned. It is then treated by a small volume of glycol or by another de-icing chemical to prevent further icing.

18.5 THERMAL DE-ICING

Thermal procedures for removing of snow and ice are not so widely used as use of mechanical means and chemicals. The reasons are the growing price of energy and the problems with maintenance of some types of facilities. None-the-less, it is possible that in some airports the local conditions can be favourable, e.g. the utilisation of waste heat or geothermal energy for removing of snow and ice from runways.

The technical feasibility of using earth heat in combination with heat pipes for deicing and

removing snow from pavement surfaces has been demonstrated (in the Baltimore/Washington climate) in testing conducted at the Fairbank Highway Research Station (located at McLean, Virginia) during two winters. A report explains the analytical models constructed to analyse earth heated pavement systems, and the validation of these models as a result of the testing conducted [22].



Figure 18-8 *Electrically heated pavement - emergency heliport on the roof of the regional hospital at Salzburg, (Photo: A. Kazda)*

In the case of asphalt pavements, a special conductive asphalt – graphite mixture could be used for an electrically heated surface layer (Figure 18-8). The system can prevent ice and/or snow surface build-up and, depending on the system, it is able to melt approximately 2.5 cm of falling snow per hour. Operating power usage is, depending on the weather conditions, between 200 – 500 W.m². Typical installations are small areas like heliports on constructions where the snow or ice clearing would be problematic. One of these systems was installed at Chicago, Illinois USA – O’Hare Airport taxiway by a company Superior Graphite under a trademark SNOWFREE.

Melting of snow is hardly used any more because of high energy consumption and low efficiency. Also at most airports the use of jet blowers, jet engines fixed on the undercarriage of the truck, is forbidden. They are expensive due to the price of fuel, noise and air pollution, but also because of

the damage to the runway. Thermal de-icing can be effective only if not only will the ice be melted but also the surface of the runway will be completely dried. The use of a jet blower causes an increase of local runway temperature, which will cause high internal stress in the concrete slab and the later appearance of cracks. The combination of high temperature and kinetic effects of jet exhaust gases can cause the destruction of the covering layer of asphalt runways.

18.6 RUNWAY SURFACE MONITORING

According to the requirements of Annex 14, Volume I the surface of the runway must be maintained in a clean state to ensure good braking action. However, from the point of view of protecting the environment and for economy, it is necessary to minimise the volume of chemicals used for removing ice. The application procedure, the application time and the necessary volume of the chemicals are affected by a number of factors, the effect of which can be difficult to assess except on the basis of operational experience. For example, a sufficient amount of heat can be accumulated in the runway pavement after a sunny day so that the pavement does not freeze even during a wet and cold night. An optimum decision can be made on the basis of data from the monitoring system, which monitors meteorological conditions and the condition of the runway and enables a forecast of the condition of the runway surface to be made. Because the monitoring system allows a substantial decrease in the requirements for winter maintenance and in the volume of chemicals used by up to 70%, this investment usually has a high rate of return.

The monitoring system must be capable not only of indicating the appearance of ice on the runway surface but also to forecast conditions leading to icing. Modern systems such as that produced by the Vaisala company use as input data the output from the sensors of automatic stations, which monitor the air temperature, dew point temperature, amount and ceiling of clouds, speed of wind, precipitation, temperature of the surface of the pavement, temperature under the surface of the runway and the residues of the de-icing fluid on the runway surface. The system is capable of forecasting the runway condition for 24 hours ahead. It is possible to enter the weather forecast into the system manually, and in this way to obtain various alternative forecasts.

On the basis of the forecast the following can be estimated:

- whether the temperature of the runway surface will fall below 0 °C
- when the temperature of the runway surface will fall below 0 °C
- whether the surface of the runway will be wet when the temperature is below 0 °C
- how long the temperature of the runway surface will remain below 0 °C
- whether the residues of de-icing material from the last application on the surface of the runway

will prevent the formation of ice.

On the basis of experience from different airports, a monitoring system that is too complicated is more of a burden than a useful aid. The Vaisala system decreases the necessary number of sensors and at the same time optimises their location by mapping the runway surface with a thermovisual camera. On each surface there are critical 'cold' places, which freeze before other surfaces on the runway.

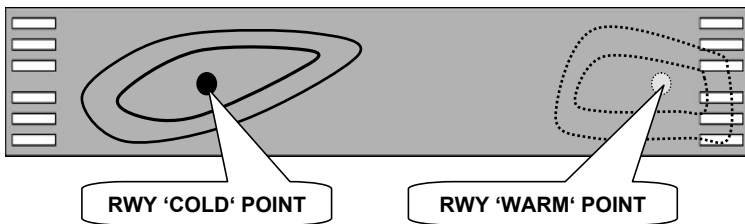

Figure 18-9 *Location of sensors in the 'cold' and the 'warm' point of the RWY*

The runway surface is scanned by the thermovisual camera under three different conditions. During a cloudless and windless night it is possible to see the maximum contrast between the 'cold' and 'warm' places on the runway (Figure 18-9). Average conditions are 5/8 cloud cover and a 2.5 to 10 m.s⁻¹ wind speed. A wet night with more than 6/8 cloud cover with the cloud base of less than 600 m gives the smallest temperature differences between individual places of the runway. After evaluation of the mapping, the sensors are placed into 'cold' places and for comparison into places which, from the point of view of temperature, are the most stable. In this way it is possible to simplify the monitoring system, to increase its reliability and to decrease the construction costs.

18.7 AIRCRAFT DE-ICING

It is dangerous for an aircraft to take off while it is contaminated by snow or ice. Creating sufficient lift requires high values for the lift coefficient. This is achieved by using flaps and slots and flying the airplane at high angles of attack. The contamination reduces the available lift due to roughening of the airfoil surface, from the premature separation of the airflow from the wing surface and from the increase of aerodynamic resistance and aircraft weight. The situation is critical during and shortly after take-off at low speeds. Research has shown that even a layer 0.5 mm thick covering the whole upper area of the wing can decrease the maximum lift coefficient by up to 33% and the stalling angle of attack from 13% to 7%. This means that even a small layer of ice is not 'insignificant'. Because of this in the majority of states it is strictly required that de-icing

is carried out prior to take-off if there is frost, ice or snow adhering to any of critical surfaces of an airplane.

According to the Association of European Airlines recommendations [7] there are two different procedures for the aircraft surfaces treatment:

De-icing is a procedure by which frost, ice, slush or snow is removed from an aircraft in order to provide clean surfaces while anti-icing is a precautionary procedure which provides protection against the formation of frost or ice and accumulation of snow or slush on treated surfaces of the aircraft for a limited period of time (holdover time).

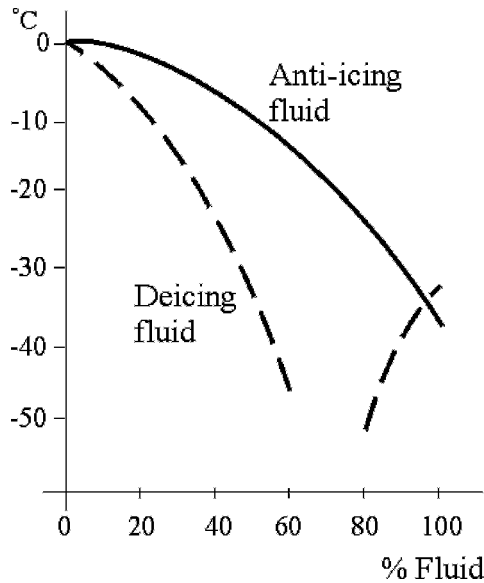

Figure 18-10 Comparison of the freezing point diagrams for aqueous solutions of Type I - de-icing fluids) against Type II - protective fluids

For the de-icing procedures, fluids based on glycol are mostly used. However, if an aircraft is covered with thick layers of snow, slush etc. some airline companies are using an effective and cheap ‘mechanical’ method – snow is simply brushed away. This leads to considerable reduction of de-icing /anti-icing fluids usage. A new infra-red de-icing method is discussed at the end of this section.

De-icing and anti icing fluids must meet a number of requirements. They must not be corrosive, they must not damage materials and aircraft coatings and must be non-flammable. Four types of

fluids are used.



*Figure 18-11 Aircraft de-icing at Vienna airport, Type I fluid is used
(Photo: A. Kazda)*

Type I – de-icing fluids are used for removing ice from the aircraft surface. However they do not provide long term protection against re-icing of the surface. They are most used in the USA. They contain more than 90% glycol, the remainder consisting of water, corrosion inhibitors, wetting agents and dye. Inhibitors ensure protection of the airframe, and wetting agents ensure the even coverage of the whole surface. Before using the de-icing fluid, it must be diluted with water in order to ensure its maximum efficiency corresponding to the concentration and temperature of the eutectic point (see Figure 18-10). Depending on the kind of glycol and the producer, this concentration corresponds approximately to 40% of water and 60% of glycol and depends also on the meteorological conditions. If coloured they must be orange (Figure 18-11).

Type II – protective (anti-icing) fluids can also be used for removing ice from the aircraft surface but mainly to protect the aircraft from re-freezing again during taxiing and waiting before take-off. All anti-icing fluids are more expensive than Type I fluids. Protective fluids are normally applied to the cleaned surface of the aircraft. As with the Type I fluids, Type II fluids contain glycol,

water, inhibitors wetting agents and dye. In addition to this they contain a polymer-based thickener. The thickener increases the viscosity of the protective fluid so that it adheres to the aircraft surface and does not flow away. The thickener is dissolved in water. The composition of protective fluids corresponds to minimum freezing point. Most Type II fluids are not diluted any more. Type II fluids are normally transparent or light yellow; allowed are all colours except orange, emerald green and blue green.

Type III - protective (anti-icing) fluids have characteristics that lie between Types I and II/IV fluids. They can provide longer holdover time than a Type I fluid but less than Type II/IV fluids. They are designed especially for turboprop aircraft performance with lower rotation speeds with V_R less than 100 knots.

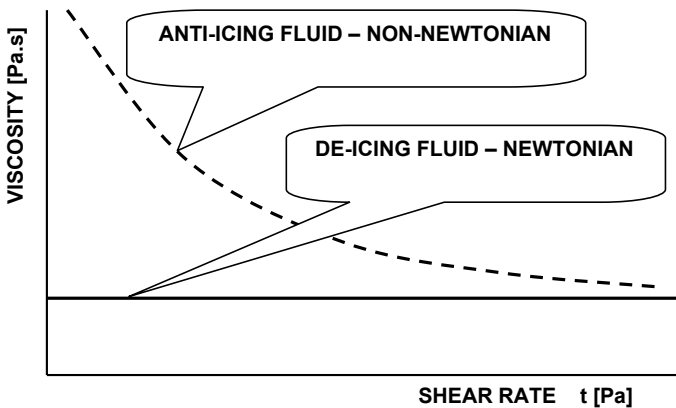

Figure 18-12 Viscosity against shear rate profiles for Newtonian and non-Newtonian fluids

Type IV – protective (anti-icing) fluids are very similar to the type II fluids but they have significantly longer holdover time. Type IV fluids are dyed emerald green. The hold over time (HOT) is defined as the period of time during which a thin layer of anti-icing fluid stays on the airplane to protect the surface against precipitation. It starts immediately with the beginning of applying fluid (one step) or with beginning of the second step in a two-step procedure [219].

Protective fluids are classed as Non-Newtonian, i.e. viscous fluids. The viscosity of a Non-Newtonian fluid changes depending on the shear on the fluid surface, as shown in Figure 18-12. The fluid has high viscosity at small values of shear and small viscosity if the shear on the fluid surface grows. This property is very important for protective fluids. When the aircraft is stationary or is taxiing, the fluid viscosity is high and the fluid adheres to the surface of the aircraft. During the take off run, the fluid experiences higher and higher shear, its viscosity is suddenly reduced and it flows from the surface of the aircraft. Ideally the fluid viscosity should be high up

to a speed of about 110 km.h^{-1} and then it should be reduced rapidly so that at the nose-wheel lifting speed, the aircraft surface is clean.

The problem, however, is that not all of the fluid is always shorn-off completely and a small amount of the fluid may remain on the aircraft, particularly in the areas where the speed of the airflow is not sufficient to blow it off [12]. After the glycol evaporates and only the thickening agent is left, residues can be formed. The thickening substance has practically no anti-freeze properties and is very hygroscopic. It can form gel-like deposits which could result in blockages of flight controls of certain types of aircraft. The more thickened the fluid is (i.e. Type IV liquids), the more deposits are formed. Depending on the meteorological conditions, and on airport and state practices, one-step or two step procedures are used for aircraft de/anti – icing.

During a ***one-step procedure*** only thickened (Type II/III/IV) fluid is used for snow/ice removal from the aircraft's surfaces and the same time to provide the protection to those surfaces.

In a ***two-step procedure*** the aircraft is cleaned by the Type I fluid first and then, within 3 minutes, the surface should be treated by the Type II or IV fluid. To make the cleaning of the aircraft easier, the de-icing fluid is applied hot and under high pressure. At a temperature of up to -7°C some airports use hot pressurised water for cleaning of the aircraft. Protective fluids are less stable and must not be therefore exposed to higher temperatures. They are applied cold. In order to avoid disrupting the function of the polymerising fluid and reduction of the fluid viscosity, the protective fluid must not be pumped by common types of rotary or piston pumps. Instead, membrane or screw pumps must be used.

In the USA and Canada, the two-step procedure is usually used but, in Europe (especially in the UK) the one-step method is prevailing instead. One of the reasons is that most of the airports in the North America use a centralised system of de-icing on special pads located close to the runway holding points. Use of Type I fluid in Europe / UK is limited. The one-step procedure necessarily means 'double' application of the thicker Type II, or even Type IV fluid. Operators from Scandinavia and Baltic countries seem to be using Type I on a much larger scale. By contrast to that, operators from the rest of Europe seem to be 'predominantly' using Type II/IV liquids [12].

Some types of wing contamination are very difficult to detect. For example clear ice is nearly invisible and a hands-on check is required to feel the build-up. The tactile check is the only known method to verify if the treated surface is clean of ice.

De-icing of aircraft can be performed in either centralised or decentralised ways. The latter is by mobile vehicles on the apron and the former way is to use one or several specially constructed stands located as close as possible to the take-off runway threshold.

In the case of decentralised de-icing (at the apron) both type I and II/IV fluids must be used so that,

during taxiing to take-off, the aircraft does not freeze again. The residues of de-icing fluids remain on the apron, and they penetrate into the substratum, where they contaminate soil and ground water. The residuals of the Type II or IV fluids together with the remaining snow or ice are very slippery, which endangers the safety on the apron. This cannot be avoided completely even on airports where de-icing is performed centrally, because propellers and the inlets of jet engines must be de-iced on the apron stands.

To ensure the protection of the environment, and to increase the safety of air operation by shortening the time between de-icing of the aircraft and its take-off, areas for central de-icing of aircraft are being built on the apron at larger airports. The design of the surfaces prevents the escape of the de-icing substance. Glycol is trapped and recycled. Recycling is in most cases performed in the production plant, because the recycled fluid must have the same properties as a new fluid, but e.g. in the case of the Munich airport recycling is performed directly on the airport. It is, in fact, difficult to trap and recycle much more than 50% of the fluid. For central de-icing, it is possible to use mobile de-icing facilities or a special portal de-icing facility. Portal type de-icing facilities have been constructed on Luleå (Sweden) and Munich airports.

Another advantage of centralised de-icing is that de-icing can be performed immediately before take-off so that in most cases it is not necessary to then protect the plane by Type II/IV fluid. This requires close co-ordination between air traffic control and the airport administration or the handling agent that provides the de-icing. Otherwise, the aircraft which has been de-iced might have to wait too long before take-off. Co-ordination with the air-traffic control is just as important in de-icing of aircraft on the apron in order to avoid long delays to the aircraft after de-icing (see 9.3 – CDM).

On Copenhagen airport and in some airports in the USA, the preventive spraying of planes by Type II/IV fluid is used after landing. It is suitable particularly for the aircraft with short turn-round time. Experience shows that as many as 95% of aircraft which had been anti-iced after landing do not have to be de-iced before take-off. The advantage of anti-icing is substantially lower consumption of de-icing fluid. On average, 230 litres of de-icing fluid is used for de-icing an MD-80 aircraft. In contrast, less than 10 litres of Type II fluid is necessary for anti-icing the same type of aircraft. There may also be an increase in airport capacity. Anti-icing takes less than a minute in comparison to between two and five minutes for de-icing. Even if some anti-iced aircraft must be de-iced before take-off, the consumption of de-icing fluid is still lower and the time is shorter than for aircraft that have not been anti-iced after landing.

De-icing of aircraft is a professional and specialised activity which has a direct effect on the safety of air transport. The workers who perform de-icing must be perfectly familiar with the de-icing equipment and with the properties of the fluids used. Increased attention has to be paid to the protection of these workers, both because of adverse weather conditions, during which the de-icing of aircraft is most frequent and necessary, and because glycol is harmful to the health.



Figure 18-13 *InfraTek de-icing facility of Radiant Aviation Services – RAS*
(Photo: Courtesy Oslo Airport)

A new de-icing technology was developed and tested during the first half of 1990's at Newark Airport by the company Process Technologies (now Radiant Aviation Services – RAS). In their InfraTek system infra-red energy working on 3 to 6 micrometers long waves is used to melt ice, frost or snow (Figure 18-13). The system is effective on ice deposits, but less when snow is present on the aircraft's surfaces. Firstly, it is because snow crystals reflect the 'heat waves' and, secondly, the air located in between the individual flakes of snow makes it a very effective insulator [12]. The radiated energy does not heat up aluminium surfaces, but affects composite materials.

The first InfraTek facility in Europe was opened at Oslo Gardermoen Airport in January 2006. The technology is not completely glycol free as a de-iced aircraft surface must be treated by some of protective, anti-icing fluids. However, glycol consumption is reduced considerably. Because of high initial costs the facility could be suitable for busy airports with severe meteorological conditions only.

19

AIRPORT EMERGENCY SERVICES

Tony Kazda and Bob Caves

Motto: Know safety – no pain; No safety - know pain.

19.1 ROLES OF THE RESCUE AND FIRE FIGHTING SERVICE

Airport administrations spend millions of dollars providing and operating fire fighting equipment, hoping that they will never have to use it. A Rescue and Fire Fighting Service (RFFS) produces costs without explicit benefits for airport administrations. As with other departments that generate no revenue, when there is a squeeze on finances at an airport, management tends to minimise spending on the RFFS. From a long-term viewpoint, the airport image may suffer from such an attitude. The safety standard of an airport is high on a list of priorities of airlines. As a rule of thumb, in the event of a serious aircraft fire, each fireman might expect to save up to five passengers. If the RFFS is under-funded, the airlines may decide to fly elsewhere. From that viewpoint, the aerodrome RFFS is one of the inseparable parts that go to create the complete ‘airport product’. If the services are of high quality, they may be an important factor in the marketing campaign of the airport.

Air transport is one of the safest means of transport. None-the-less, there is a finite probability that an accident will occur sooner or later. The accident statistics show that the majority of aircraft accidents happen during take-off and landing, that is to say, in the vicinity of airports. The airport

operator must be prepared for such an eventuality. During take-off, there is a maximum quantity of highly inflammable fuel on board. A severe accident usually causes a break in the integrity of the aircraft's fuel tanks, leading to the escape and atomising of the fuel and a subsequent fire. An extensive fuel fire brings the greatest probability that the passengers will not survive the accident. The principal task of the RFFS is to save human lives. The necessary level of provision of RFFS does not depend only on the aerodrome size, for example with regards to the runway length to be covered in order to reach an accident site, but also on the size of the aircraft. The demands upon the RFFS at international airports have been gradually increasing because ever larger aeroplanes with greater fuel volumes and greater seat capacity have been put into operation.

Fortunately, serious accidents with fire, and hence a heavy death toll, occur only rarely (see Table 4-3). More often, there are smaller incidents like spilled fuel and incipient emergency situations like undercarriage failures that the RFFS must attend. Most events are not connected with aircraft at all, but concern fire alerts in the terminals, road accidents, and other emergencies that would be expected in any city.

19.2 LEVEL OF PROTECTION REQUIRED

19.2.1 Response Times

The required level of provision of the RFFS is established in Annex 14 and in Airport Services Manual: Part 1 - Rescue and Fire Fighting.

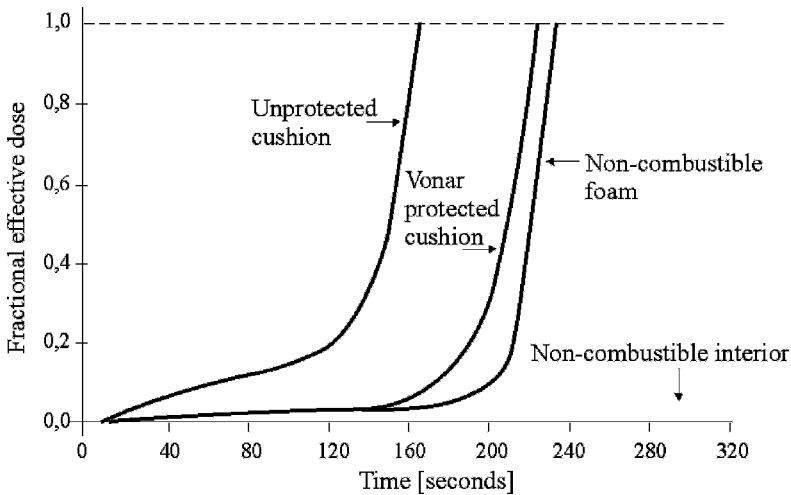
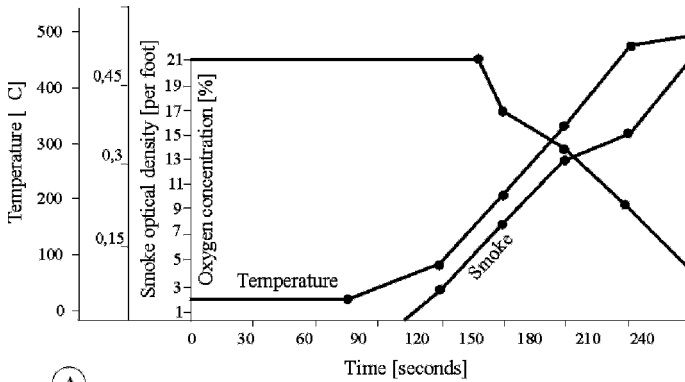

Figure 19-1 *Effect of cushioning protection and materials on calculated survival time*

The most important requirements are the speed and the effectiveness of the response to the

emergency, which are defined by maximum times for the response to the emergency and to control the fire.



(A)

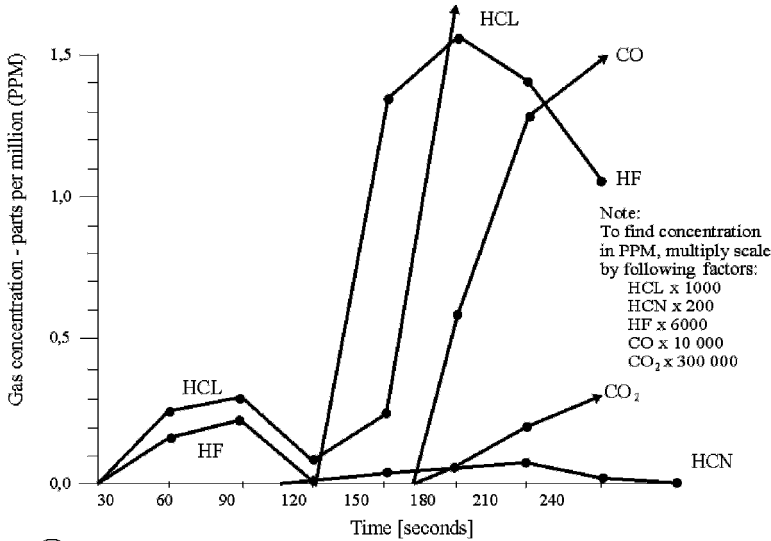

(B)

Figure 19-2 Aft cabin hazards resulting from burning interior materials

The maximum response time criterion is that the RFFS should reach any location in the operational runway system and any other part of the movement area where the accident may have occurred and begin the rescue operation preferably within two minutes and not exceeding three minutes in optimum visibility and surface conditions. The response time is the time between the initial call to the RFFS and the time when the first emergency vehicle is in position to discharge the extinguishing agent with at least 50% of its maximum rate. The other vehicles must arrive on the

spot not later than one minute after the first fire engine to provide uninterrupted fire extinguishing.

The control time criterion is that 90% of the fire's extent should be extinguished within one minute from beginning to fight the fire. The total time that an emergency is expected to last is not specified, but it should clearly be as short as possible.

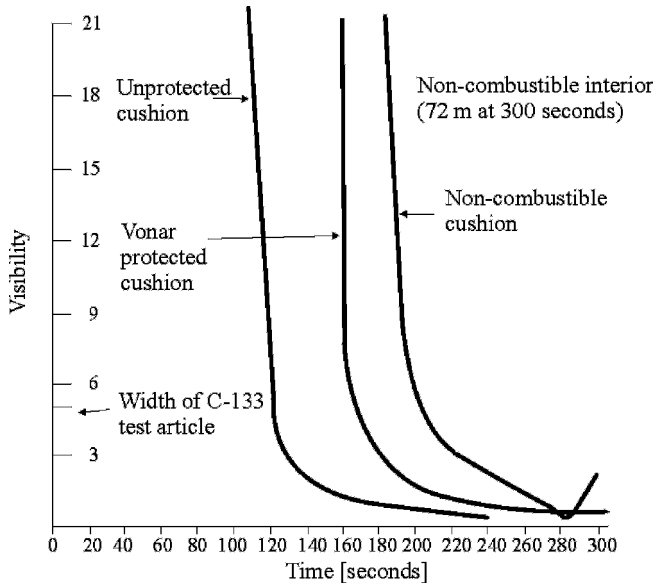

Figure 19-3 *Effect of cushioning protection and materials on calculated visibility through smoke*

Although it may seem that the response time criteria are strict, the times have been determined on the basis of real conditions, statistics of accidents and the subsequent fires. They also closely match the certification criteria for the aircraft, which require a demonstration that all the passengers be able to exit the aircraft within 90 seconds using only 50 per cent of the exits. In 1980, the FAA performed tests of the effects of fire on a model of a wide-body aircraft. The results showed that in aircraft not equipped with seats made of flameproof or fire-blocking materials, the possibility of rescuing the people who have survived the first seconds of the accident rapidly drops after 120 seconds from the beginning of the fire. If the seat upholstery is covered with a material called Vonar, or if the seats are entirely flameproof, the time of survival increases to approximately 180 seconds, as shown in Figure 19-1.

The flames themselves are not the only threat to life. The high temperature raises the concentration of asphyxiant and irritant gases, and lowers the level of oxygen in the cabin (see Figure 19-2). The evacuation of the passengers is aggravated by a rapidly declining visibility as a

consequence of thick smoke. In some cases the visibility declines from the full cabin length to only the cabin width within 15 seconds (see Figure 19-3).

19.2.2 Aerodrome Category for Rescue And Fire Fighting

The required level of fire protection to be provided at an aerodrome should be determined by the dimensions and number of movements of the aeroplanes using the aerodrome. The aerodrome shall be ranked into one of ten categories based on the fuselage length and width of the longest (critical) aeroplane (see Table 19-1). If the width of the critical aeroplane fuselage is greater than the maximum allowed in Table 19–1, after selecting the category appropriate to the longest aeroplane, then the actual category shall be one number higher.

Table 19-1 Aerodrome category for rescue and fire fighting

Aerodrome category	Aeroplane overall length	Maximum fuselage width
1	0 m up to but not including 9 m	2 m
2	9 m up to but not including 12 m	2 m
3	12 m up to but not including 18 m	3 m
4	18 m up to but not including 24 m	4 m
5	24 m up to but not including 28 m	4 m
6	28 m up to but not including 39 m	5 m
7	39 m up to but not including 49 m	5 m
8	49 m up to but not including 61 m	7 m
9	61 m up to but not including 76 m	7 m
10	76 m up to but not including 90 m	8 m

(Source: Annex 14, Volume I, Aerodromes, Chapter 9)

During low traffic periods, the level of rescue and fire fighting may be reduced so that it corresponds to those types of aeroplanes which are intended to use the aerodrome at that time. The amounts of extinguishing agents or the amounts of water necessary for their preparation (see Table 19-3) and the numbers of fire fighting vehicles (Table 19-4) at the aerodrome shall be determined by the aerodrome’s rescue and fire fighting category.

19.2.3 Principal Extinguishing Agents

Both principal and complementary extinguishing agents should be provided at an aerodrome. The exceptions are aerodromes ranked in the 1st and 2nd category, where the entire amount of water for production of principal extinguishing agents may be replaced by complementary agents and, in the case of aerodromes between categories 3 – 10 when a foam meeting criteria for 'A' level performance is used, up to 30 per cent of the water may be replaced by complementary agent. In this case one kilogram of complementary agent can replace 1 litre of water for 'A' performance level foam and 0.66 litre of water for 'B' performance level foam. The principal extinguishing agents facilitate the extinguishing and long-lasting control of fire. It is also recommended that for aerodromes in categories 1 to 3, 'B' performance level foams should be used.

The traditional principal extinguishing agent was a protein foam. It creates a resistant and stable foam cover consisting of an aggregation of bubbles of a lower specific weight than the fuel or water, suitable for covering, extinguishing and cooling the hot aeroplane fuselage. The foam should have strong cohesive qualities and be capable of covering and clinging to vertical and horizontal surfaces. Aqueous foam cools hot surfaces by its high water retention ability and must flow freely over a burning liquid surface to form a tough, air-excluding blanket that seals off volatile flammable vapours from access to air or oxygen. Good-quality foam should be dense and long lasting, capable of resisting disruption by wind or draught, stable to intense thermal radiation, and capable of re-sealing in event of mechanical rupture of an established blanket [111]. The basic component of the foam concentrate is a hydrolysed protein complemented with stabilising additives suppressing decomposition of the foam at high temperatures, inhibitors of corrosion, antibacterial additives and antifreeze additives. It shall be mixed with water in a concentration of 3%; 5% or 6% according to the type of extinguishing device and the kind of extinguishing agent and its performance criteria. A problem may arise with incompatibility of the protein foam with some kinds of extinguishing powders which may decompose it. The protein foam usually complies with the criteria for the 'A' level principal extinguishing agents.

The Aqueous Forming Foam (AFFF) - is very effective for spilled burning fuel. It is a surface active agent consisting of perfluorinated surfactants with a foam stabiliser and viscosity control agents. The AFFF does not have the appearance of a protein or fluoroprotein foam. At high temperatures the layer of this agent decomposes. It is unstable. The AFFF is not suitable for fires containing large quantities of hot metal. However, it acts both as a barrier to exclude air or oxygen and, in addition, it produces an aqueous film on the fuel surface capable of suppressing the evolution of fuel vapours. Ideally, the foam blanket produced by the AFFF should be of sufficient thickness so as to be visible before fire fighters rely on its effectiveness as a vapour suppressant [111]. The concentrate shall be mixed with water in concentration of 1% to 6%. The AFFF usually complies with the criteria for the 'B' level principal extinguishing agents.

The Fluoroprotein Foam is a combination of the protein foam with fluorocarbonate. This increases the fluidity of the foam and improves re-ignition characteristics. It is very effective at extinguishing deeper layers of fuel, for example for subsurface application in fuel tanks, because it inhibits penetration of the burning fuel to the surface through individual foam bubbles. In comparison with the protein foams, it demonstrates better compatibility with extinguishing powders. Although the fluoroprotein foams are generally more expensive than the protein ones, their advantage is in higher efficiency and lower consumption of water. Depending on the type of extinguishing device, it shall be mixed with water in a concentration of 3% to 6%. It is an agent complying with the criteria for the ‘B’ level principal extinguishing agents.

Table 19-2 Foam specifications

Fire tests	Performance level A	Performance level B
1. Nozzle (air aspirated)		
a) Branch pipe	UNI 86 – foam nozzle	UNI 86 – foam nozzle
b) Nozzle pressure	700 kPa	700 kPa
c) Application rate	4.1 l/min/m ²	2.5 l/min/m ²
d) Discharge rate	11.4 l/min	11.4 l/min
2. Fire size	2.8 m ² (circular)	4.5 m ² (circular)
3. Fuel (on water substrate)	Kerosene	Kerosene
4. Preburn time	60 s	60 s
5. Fire performance		
a) Extinguishing time	≤ 60 s	≤ 60 s
b) Total application time	120 s	120 s
c) 25% re-ignition time	≥ 5 min	≥ 5 min

(Source: Airport Services Manual: Part 1 - Rescue and Fire Fighting)

The Film Forming Fluoroprotein Foam (FFFP) is a modern extinguishing agent, highly effective for spilled fuel. The surface tension in the expanded foam is reduced so it can spread across the surface of a fuel. It is a combination of protein foam with a surface active agent on a base of fluorocarbonate. The extinguishing agent forms a water solution with properties of an oily material on the surface of spilled fuel. Therefore the extinguishing agent rapidly spreads on the burning fuel surface, inhibiting the access of air and suppressing evaporation of the fuel. As with

other agents, it is used in a concentration of 3% to 6%. It is compatible with the majority of extinguishing agents. It complies with the criteria for the 'B' level principal extinguishing agents.

All principal agents are so called 'mechanical foams' produced similarly to whisked egg-white.

The synthetic foams are produced from petroleum products. They are convenient for extinguishing fires in closed rooms and to some extent for spilled fuel.

The specifications for 'A' and 'B' principal extinguishing agents include physical properties and the performance of the foams under fire test conditions. These include the data on the discharge monitors, quantity and velocity of delivery of the extinguishing agent, the extent of the fire, the speed of extinguishing the fire, and on the resistance of the extinguishing agent against a new flare-up of the fire (see Table 19-2).

If it is necessary to raise the aerodrome category for rescue and fire fighting, and an extinguishing agent complying with the 'A' level criteria is used at the aerodrome, the agent may be replaced by an extinguishing agent complying with the 'B' level criteria which requires smaller quantities of water.

19.2.4 Complementary Extinguishing Agents

According to the Annex 14, Volume I, Chapter 9 requirements, the complementary extinguishing agents should be dry chemical powders. Carbon dioxide was banned as an extinguishing agent as it is considered to be one of the main contributors to the global warming. The halon-based agents have strong ozone layer depletion potential. The Montreal Protocol required their earliest production and import phase-out in the U.S. by 1994. However, there are complementary extinguishing agent substitutes available fulfilling also FAA Minimum Performance Standards and U.S. Environmental Protection Agency criteria which can replace Halon 1211 widely used at airports. The Halotron® I is a product which has completed the full-scale fire test performance evaluation and was approved for airport fire fighting use in the USA. It is also a more environmentally friendly replacement for Halon 1211 accepted by the Environmental Protection Agency [111].

The complementary extinguishing agents are very effective and facilitate quick suppressing of the fire. However, they are effective only while being applied, and do not protect against a new flare-up of the fire. Therefore they are used for the first strike, before the arrival and intervention of the major fire engines. They are also effective within enclosed rooms like baggage lockers, spaces under the aeroplane wings and undercarriage bays, where the foams are not effective. Their further use is during specific local fires, such as to tires, wheel discs, engine, etc.

Dry chemical powders are among the most effective complementary extinguishing agents. They are the most convenient agents for extinguishing fuel spills and three dimensional fires. A disadvantage of the powders is that they do not cool the extinguished object when they are applied. If a greater amount of powder is used, it may form a cloud which reduces visibility and causes breathing difficulties. Powders are based on potassium hydrocarbonate, potassium chloride and ammonium phosphate. Carbamide powder, a product of the reaction of potassium hydrocarbonate and urea and offered in the market under the name Monnex, is several times more effective. Dry powders should comply with the ISO 7201 standard.

19.2.5 The Amounts of Extinguishing Agents

The amount of water for particular aerodrome categories shall be derived from a theoretical critical area which should be extinguished. The theoretical critical area is an area around the aeroplane in which the fire should be extinguished, and which allows survival and escape of the passengers from the aeroplane. The dimensions of the critical area have been determined experimentally. The theoretical critical area has a rectangular shape. One of its sides is equal to the length of the aeroplane fuselage. The other side of the critical area is equal to the greatest width of the aeroplane augmented by 24 m on one side and 6 metres on the other side of the fuselage with respect to the wind for aeroplanes whose fuselage length is equal to or greater than 20 m. For aeroplanes with a fuselage length shorter than 20 m, the critical area shall be widened by 6 m on both sides from the greatest width of the aeroplane fuselage.

In the majority of incidents, only two thirds of the theoretical area - the real critical area - are caught by the fire. The total amount of water shall be determined from the real critical area, the amount of water required per square meter per minute and the extinguishing time, with 60 s as the control time. Then the amount is augmented by the water required for extinguishing the remains of the fire. The minimum amounts of water for extinguishing agent production and particular aerodrome categories are given in the Table 19-3.

The quantities of water are determined on the average overall length of aeroplanes in a given category. If an aeroplane with larger dimensions operates from an airport, the quantities of water must be recalculated. It is recommended that the quantity of foam concentrates on a vehicle should be sufficient to produce at least two charges of foam solution. There must be a reserve supply of foam concentrate and complementary agents at the airport at least equivalent to 200% of required amounts to be provided in the fire engines for vehicle replenishment purposes.

In many cases, considerably larger amounts of water are required for extinguishing an aeroplane fire than those recommended in Table 19-3. In the majority of events the amount may even

double. Therefore it may be expected that in the future the requirements for the amount of water will be raised.

Table 19-3 Minimum usable amounts of extinguishing agents

Aerodrome category	Foam meeting performance level A		Foam meeting performance level B		Complementary agents
	Water [l]	Discharge rate foam solution/minute [l]	Water [l]	Discharge rate foam solution/minute [l]	Dry chemical powders/* [kg]
1	350	350	230	230	45
2	1 000	800	670	550	90
3	1 800	1 300	1 200	900	135
4	3 600	2 600	2 400	1 800	135
5	8 100	4 500	5 400	3 000	180
6	11 800	6 000	7 900	4 000	225
7	18 200	7 900	12 100	5 300	225
8	27 300	10 800	18 200	7 200	450
9	36 400	13 500	24 300	9 000	450
10	48 200	16 600	32 300	11 200	450

**/ Any other complementary agent having equivalent fire fighting capability may be used.*

(Source: Annex 14, Volume I, Aerodromes, Chapter 9)

It must be emphasised that the determined minimum amounts of extinguishing agents should be constantly available on rescue and fire fighting vehicles. In the event that all the rescue and fire fighting vehicles participate in the intervention, the aerodrome should be closed. If only a certain number of the rescue and fire fighting vehicles participate in the intervention, the aerodrome category for rescue and fire fighting should be temporarily downgraded. The administrations of large airports make efforts to provide a continuous operation, and if possible, without any limitations. In that case they must provide a greater quantity of extinguishing agents and numbers of rescue and fire fighting vehicles than required for a single emergency.

19.3 RESCUE AND FIRE FIGHTING VEHICLES

The task of the rescue and fire fighting vehicles is to reach the accident location as soon as possible, to provide escape routes, to liquidate the fire, and to begin rescue actions.

Table 19-4 Number of rescue and fire fighting vehicles

Aerodrome category	Rescue and fire fighting vehicles
1 – 5	1
6 – 7	2
8 – 10	3

(Source: Annex 14, Volume I, Aerodromes, Chapter 9)

The minimum determined numbers of rescue and fire fighting vehicles must facilitate the transport of the required amounts of extinguishing agents to the fire's location and their effective application. The number of rescue and fire fighting vehicles depend on the aerodrome category, as shown in Table 19-4. In determining the number of rescue and fire fighting vehicles, not only the amount of extinguishing agents carried by them is important, but also the possibility of applying them so that the entire aeroplane fuselage can be covered. If, for example, 3 600 litres of extinguishing agent should be provided at the aerodrome, is it more appropriate to have available two vehicles, each of them carrying 1 800 litres, with which the attack may be conducted from two points, than only one with the entire amount. At the same time, it is necessary to assess the capital cost of the rescue and fire fighting vehicle, and their replacement approximately every 10 to 15 years, and the operating costs, which will be higher with two vehicles and also higher operational costs because more crew is usually needed for two fire engines. The capacity of the vehicle tank for foam concentrate should correspond to at least two full loads of such quantity of water that is necessary for foam production at the determined concentration.

The original ICAO concept determined separately the numbers of the so called rapid intervention vehicles equipped in the majority of cases with complementary agents, powders in particular, and major vehicles which carried the load of water for the preparation of principal extinguishing agents (Figure 19-4). The rapid intervention vehicles reached the accident location first and began the fire fighting intervention.

The major vehicles had to reach the incident location before the rapid intervention vehicle consumed all its extinguishing agents (Figure 19-5). That concept was invalidated by the technical

limitations of the older types of major vehicles with which it was not possible to fulfil the required response time. At present parameters are determined separately for vehicles with a volume of water up to 4 500 l and above 4 500 l (see Table 19-5). The fire fighting intervention should be started within the limit of the response time with at least 50% of the performance given in the Table 19-3. All the remaining vehicles must reach the accident location within 1 minute after the first vehicle.



Figure 19-4 *Rapid intervention vehicles must reach the accident location first*
(Photo: A. Kazda)

The majority of vehicles are custom-made in close co-operation with the customer. Besides the basic equipments, the customer may order other special equipment which exceeds the current standard. In an attempt to reduce the costs of RFFS, personnel costs in particular, efforts have been made to use more and more sophisticated rescue and fire fighting vehicles, so reducing the number of employees. Such equipment may substantially ease the intervention and make it more effective, or minimise human factor errors. On the other hand, it increases costs of acquisition and maintenance. The failure of any of the sophisticated components might cause the vehicle to be unavailable. If a failure occurs of the main systems of the rescue and fire fighting vehicle during a rescue and fire fighting intervention, for example the monitor or valves which are equipped with a remote control with boosters, it should be possible to disable the remote control and to control the system manually. Therefore, when specifying the requirements for a new vehicle, a compromise must be made between the vehicle's simplicity, the extent of the additional equipment, price,

operating costs, and its availability.

Table 19-5 Minimum characteristics recommended for rescue and fire fighting (RFF) vehicles

Parameter/equipment	RFF vehicles up to 4 500 l	RFF vehicles over 4 500 l
Monitor	Optional for categories 1 and 2 Required for categories 3 to 10	Required
Design feature	High discharge capacity	High and low discharge capacity
Range of monitor	Appropriate to longest aeroplane	Appropriate to longest aeroplane
Handiness	Required	Required
Under truck nozzles	Optional	Required
Bumper turret	Optional	Optional
Acceleration	80 km.h ⁻¹ within 25 s	80 km.h ⁻¹ within 40 s
Top speed	At least 105 km.h ⁻¹	At least 100 km.h ⁻¹
All-wheel drive	Yes	Required
Automatic or semi-automatic transmission	Yes	Required
Single rear wheel configuration	Preferable for categories 1 + 2 Required for categories 3 to 10	Required
Minimum angle of approach and departure	30°	30°
Minimum angle of tilt (static)	30°	28°

(Source: Airport Services Manual: Part 1 - Rescue and Fire Fighting)

The assessed optional characteristics and equipment of the vehicle may be classified into two basic groups:

- fire fighting and rescue equipment
- performance and driveability of the vehicle.

One of the basic requirements is a perfect view from the vehicle facilitating an effective performance of the rescue and fire fighting intervention even in bad visibility. Nozzles that spray

the extinguishing agent under the vehicle may permit the vehicle to pass through the fire, though some would argue that the fire should have been knocked down before the vehicle penetrates the area. The monitor on the front bumper facilitates fighting a fire in such spots that are beyond the reach of the main monitor installed on the roof of the vehicle, for example under the aeroplane wing. If the aerodrome is used by aeroplanes with rear mounted engines, or with the third engine installed in the fin of the aeroplane, it is necessary to be able to apply extinguishing agents up to a height of 10.5 m.



Figure 19-5 Main vehicle carry water for the foam preparation

(Photo: Courtesy of Bratislava M.R. Štefánik Airport)

It should be emphasised that during each rescue and fire fighting intervention the firemen act under a great psychological pressure, sometimes they are overcome with stress to the extent that they need professional support after the emergency. Although the modern vehicles permit a single fireman to perform the rescue and fire fighting intervention, it is more convenient if one fireman is dedicated to driving and the other to the control the monitor. The cabin should protect the crew completely. A low level of noise allows communication between the crew members and by the means of a radio with the air traffic control, or other staff participating in the rescue and fire fighting intervention. The rugged front of the vehicle should facilitate its passage through obstacles, such as gates, fences and smaller trees. Ventilation or air-conditioning in the cabin is

important as protection of the crew against heat. It should be possible to hold the control handles and levers with hands in gloves, and the symbols must be readable even in bad light conditions and under vibrations.

The majority of manufacturers of the rescue and fire fighting vehicles mount the special fire fighting equipment on different types of undercarriage. Thus the buyer has the possibility of unifying the vehicle stock and of reducing the costs of spare parts.

In addition, when contemplating the purchase of a new rescue and fire fighting vehicle, it is necessary to consider its size and mass relative to the parameters of the communications and equipment in the area of the aerodrome and in its close vicinity. In particular, the dimensions of underpasses, tunnels, the load bearing capacities of bridges and pavements which may be used by the vehicle during a rescue and fire fighting intervention should be noted. In the majority of events, the vehicle needs to be capable of coping with poor terrain and thus have an all-wheel drive.

If in the aerodrome vicinity there is difficult terrain, special vehicles and equipment should be available. The terrain may include:

- large water surfaces, in the area of approach and take-off in particular
- swamps and similar areas, including river estuaries
- mountain areas
- deserts
- areas with large quantities of snow in winter.

Helicopters, hovercraft, boats, amphibians and land rovers may be utilised as special means and vehicles. However, the airport can co-operate with special rescue services to be able to respond to this types of emergencies.

The RFFS requires a whole range of ancillary equipment if it is to function successfully in all circumstances. These include breathing apparatus and qualified staff to use it, extending ladders and floodlighting masts.

19.4 AIRPORT FIRE STATIONS

The location of a fire station at an airport is crucial for fulfilling the response time requirements (Figure 19-6). All the remaining criteria which may influence the location of the fire station among the other facilities in the airport are subordinate to this. In order to fulfil the response time

limit, two or more fire stations should be provided in airports with an extensive runway system. Each of them should be located near the ends of the instrument runways, where accidents occur most. If more airport fire stations are provided, one of them is usually established as the main fire station, and the remaining are designated as satellite sub-fire stations. One or more rescue and fire fighting vehicles are located in each airport fire station. The total number of extinguishing agents is divided so as to be sufficient for the first intervention. Vehicles from the second airport fire station should reach the place of accident within one minute after the first rescue and fire fighting vehicle.

When the location of a new fire station is considered, an assessment should also be made of the further development of the airport, and of the runway system in particular. If possible, the access from the fire station into the runway should be direct, without unnecessary turns.

In the past, airport fire stations were designed very functionally with minimum facilities for the crews. On the basis of investigations and operational experience, it has been found that the precondition for a successful rescue and fire fighting intervention is not only perfect technical equipment but also the psychological and physical well-being of the rescue crew. The extent and size of particular rooms should differ according to whether it is the main airport fire station or a satellite one, but in the majority of cases there will be the following facilities:

- garages for the rescue and fire fighting vehicles allowing their regular daily maintenance
- work and rest facilities for the staff
- communication and alarm systems
- storage rooms for technical support of the rescue and fire fighting vehicles, provision of extinguishing agents and fire fighting outfit and equipment.

The garages should be designed in such a way that there is enough space around the vehicles, at least 1.2 m on each side, even if bigger vehicles are acquired in the future. The garages should be heated to a temperature of 13 °C as a minimum. The rescue and fire fighting vehicles require connection with a supply of direct current for accumulator charging and permanent heating of oil, and compressed air. When the vehicle starts, the connectors must be automatically disconnected. In order that it should not be necessary to leave the garage with the vehicles to make the regular engine checks, ventilation should be provided for the exhaust gases. It must be possible to open the door quickly, preferably by a remote control from the watchtower. In the event of a failure of its automatic system, it should be possible to open it manually. A broken-down vehicle must not block the exit for the others.

The work and rest facilities for the staff should include locker rooms and sanitary installations, a multifunctional room for training and resting, with a kitchen for the preparation of meals. The size

of the offices will depend on the extent of tasks to be provided by the respective airport fire station.



Figure 19-6 *A fire station should be located in the centre of runway system*
(Photo: Courtesy of Bratislava M.R. Štefánik Airport)

A view should be provided over the largest portion possible of the movement areas from the watchtower. The alarm is usually given from the watchtower, and activity with other units co-ordinated from there during a rescue and fire fighting intervention. The communication systems of the watch tower should provide:

- ➔ direct telephone connection with air traffic control
- ➔ radio connection at the frequencies of the air traffic control for monitoring the radio correspondence, or for a direct communication with the crew of the aeroplane
- ➔ radio connection with the rescue and fire fighting vehicles, or a connection between the main and satellite airport fire stations (if constructed)
- ➔ dedicated telephone connection with fire fighting units in the airport vicinity and other services participating in a rescue and fire fighting intervention (police, hospital)
- ➔ a siren or other alarm system and a public address radio system.

The majority of airports are not prepared to receive the great number of telephone calls which follow a flight accident. For example, after the destruction of the B 747 Pan American air liner, Flight 103, over Lockerbie in December 1989, approximately 15 000 calls were registered every 15 minutes at Heathrow Airport. In the event of an accident to an aeroplane with 140-seats, on the

first day, approximately 10 000 to 12 000 telephone calls may be expected at the airport. On the second day, that number drops by one half and on the third day by one half again. Thus the callers block the telephone exchange which is needed for the connection with other units according to the alarm schedule. There are computer systems available which allow the telephone lines to be used only for outward calls, and according to a programme, they dial sequentially the particular units that are supposed to participate in the rescue and fire fighting intervention. Provision should be made for the reception and briefing of the meeters and greeters who will need information on their relatives and friends.

Storage areas and other areas of technical support should allow the storing of extinguishing agents, their loading into vehicles and the storing and maintenance of rescue and fire fighting suits and equipment. A facility should be constructed for the drying of hoses and other equipment. The airport fire station should have its own stand-by source of electrical power or a connection to another stand by source. Emergency water tanks should be located near the runway thresholds to replenish the tenders.

A training area is required, with either an old wreck or a special rig that can be adapted to represent a variety of different aircraft types (e.g. under-wing or fuselage-mounted engines). It should be sited where fire-fighting activities will not interfere with the normal operation of the airport. It should be designed so that none of the contaminants generated by the exercise can enter the ground water.

19.5 EMERGENCY TRAINING AND ACTIVITY OF RESCUE AND FIRE FIGHTING UNIT

19.5.1 Training

The number and the level of training of firemen at the airport should correspond to the types of rescue and fire fighting vehicles used at the airport and to the maximum supply of the extinguishing agents for which the vehicles are designed. In determining the number of professional firemen, consideration should be given to the types and number of movements of the aeroplanes using the aerodrome. If there are only a few movements of aeroplanes during the day, the jobs may be done one after another by a single workman, for example, fireman and baggage handler. All the personnel intended to participate in rescue and fire fighting actions should have specialised training and periodical tests in order to be able to perform their duties. In addition, the personnel who are intended to operate the rescue and fire fighting vehicles should be familiar with the driveability of the vehicle on different types of surfaces, including soft terrain.

Personnel should be trained so that, in the event of a rescue and fire fighting intervention, they are

able to perform the activity entirely independently, without orders being given by the rescue commander. In critical situations, they should be capable of making decisions and to assume responsibility for their decisions.

The training of the rescue and fire fighting unit personnel may be divided into two categories:

- basic training in skills and use of the rescue and fire fighting equipment, familiarisation with the airport vicinity and aircraft equipment
- tactical training in extinguishing different types of fires and equipment, fire fighting and rescue actions (Figure 19-7).



Figure 19-7 Tactical training in extinguishing different types of fires is also required
(Photo: Courtesy of Bratislava M.R. Štefánik Airport)

The entire training programme should ensure that all members of the rescue and fire fighting unit are convinced that they are able to control fully the respective equipment, that the equipment functions without failures and that they are able to manage the assigned task. The acquired skills and abilities quickly degrade if not continuously practised.

The basic skill training comprises knowledge of different kinds of fire, types of extinguishing agents and their utilisation, technical parameters and control of all equipment to such a level that the usage and control of the equipment becomes fully automatic. An aspect of becoming familiar with the airport vicinity is the task of recognising both the most rapid and alternative routes to

different areas under any type of weather conditions. All members of the rescue and fire fighting unit should, most importantly, know all the types of aircraft using the airport, in particular:

- location of the exits and emergency exits of the aeroplanes, and how to open them
- configuration of seats
- kind and amount of fuel and location of tanks
- location of accumulators
- position of the points designed for a forcible entry into the aeroplane fuselage.

The purpose of the operational training is to perfect rescue and fire fighting behaviour using models simulating real conditions of an aeroplane and its parts, such as engines, undercarriages, aeroplane fuselage, cabin, and the like, on fire under different weather and visibility conditions. The training should be repeated in intervals shorter than one month.

Depending on the airport size and the national regulations, the airport operator is obliged to perform a full fire emergency exercise once a year, simulating the response to a high extensity aircraft accident. The purpose of such training is to verify the competency of the rescue and fire fighting unit and the co-ordination of activity with the units of fire services in the airport vicinity, police and health and emergency service. These exercises should be complemented by much more frequent 'table-top' exercises.

19.5.2 Preparation for an Emergency Situation and Rescue and Fire Fighting Intervention Control

At every airport, an emergency plan must be prepared for different types of emergency situations. The main purpose of the emergency plan is to minimise the effects of an unexpected event while also minimising the effect on flight operations. The airport emergency plan comprises the procedures which should be followed during the given type of emergency situation. The procedures include the sequence and range of responsibilities of each of the units participating in the rescue and fire fighting intervention. A serious accident always requires co-ordination and close co-operation with the fire units and hospitals in the airport vicinity. The units participating in the rescue and fire fighting intervention may include air traffic control, fire units of the airport, local fire brigades, police, emergency service, hospitals and health centres, telecommunications, military, civil aviation authority and representatives of the airline company. The main communications are between the airport fire unit and the air traffic control unit.

The contents of the airport emergency plan may be divided into:

1. Preparation of the airport for emergency situations, including the issues concerning

organisational structure, responsibilities, testing the functional status of the equipment and clothing, and training of the personnel.

2. The activity during an emergency situation. This section describes procedures and tasks of the particular units participating in the rescue and fire fighting intervention.
3. The activity after termination of the emergency situation. These are activities which must be completed, but do not require an immediate solution, and the return of the airport to its regular operation (Figure 19-8).



Figure 19-8 The airplane recovery after runway end overrun
(Photo J. Mach)

The airport emergency plan should cover the issues concerning accidents both on the aerodrome and also outside the aerodrome boundary. The control of the rescue and fire fighting intervention at an accident on the aerodrome is usually within the competencies of the airport administration. The control of the rescue and fire fighting intervention at an accident out of the aerodrome depends on the laws and regulations in the given country and on the agreements between the airport administration and rescue and fire fighting units in the airport vicinity.

In some states the activity of the rescue and fire fighting service is limited to the area demarcated by the airport perimeter. In other countries, the area of responsibility is greater. When there is an

accident of an aeroplane off the aerodrome, the necessary extent and the speed of the rescue and fire fighting intervention is, in the majority of cases, beyond the capabilities of local fire units. In addition, it is a specialised activity. Therefore the airport fire unit often responds to an accident a considerable distance from the airport. For example, at an emergency landing of SAS MD-81 airliner on 27th December 1991, 20 km north-west from Arlanda, three fire fighting vehicles were sent there despite the aerodrome category for rescue and fire fighting of the Stockholm - Arlanda airport having to be temporarily lowered. In the event of an accident more than 4 kilometres beyond the perimeter of London Heathrow Airport, the airport usually sends 50% of its rescue and fire fighting units to the place of the accident. Further than that, a special vehicle with cutting and extrication devices will be probably sent at the request of the intervention commander.

The emergency plan should comprise the maps of the airport and its surroundings with grids in two different scales. The more detailed grid maps shall include access roads to the airport, location of water sources, emergency assembly points and parking bays. In addition to those data, the other map shall include information about hospital facilities to a distance of approximately 8 km from the airport reference point. By the means of a grid map, it is possible to identify with sufficient exactness the place of accident or of any other point in the area in question. In conditions of low visibility, the rescue and fire fighting unit may be guided to the area of the accident by means of radar in co-operation with the air traffic control, but other means for RFFS guidance like GPS or A-SMGSC systems are used also. The officer in charge shall establish three zones of activity. Access to the crash zone should be confined to the RFFS. The rescue zone should be close by, and provide an immediate reception zone for survivors. The command post will normally be there. This will also be the rendezvous point for vehicles so that they can receive direct instructions if there is any sort of communications breakdown. The medical zone should be near hard standing, so that ambulances can drive up easily.

The activity of the rescue and fire fighting unit shall differ according to the category of emergency. The particular types are indicated as follows:

3rd degree of alert – ***‘aircraft accident’*** - is declared if an aeroplane accident happens in the airport or in its vicinity. It shall be declared by the air traffic control or by the watchtower of the fire fighting unit.

2nd degree of alert – ***‘full emergency’*** - is declared if it is known, or if there is a suspicion that an aeroplane on approach has problems which may lead to an accident. It is declared by the air traffic control.

1st degree of alert – ***‘local standby’*** - is declared if it is known, or if there is a suspicion that an aeroplane in approach has a failure, however not of such a nature that it could seriously affect the safety during landing. The local standby is declared by the air traffic control.

19.6 RUNWAY FOAMING

Passenger aeroplanes with the mass over 5 700 kg with damaged or retracted undercarriages cannot land on a grass strip for emergency landing. On a strip with a low load bearing strength, the aeroplane would sink in and decelerate abruptly, with extensive damage to the structure and possible casualties. Therefore heavy passenger aeroplanes must use a paved runway for a gear up landing. In these cases, the runway or a part thereof is sometimes covered with a protein foam blanket. Other kinds of extinguishing agents are not suitable for covering of the runway because they quickly decay.

In spite of the fact that the advantages of a foam blanket have not been entirely vindicated, it is recommended to lay one down if the aircraft captain is convinced that the foam will increase the level of safety during an emergency landing.

Theoretical advantages of a foam blanket are as follows:

- reduction of deceleration forces
- reduction of damage to the aeroplane
- reduction of the risk of creating sparks when the aircraft slides across the runway surface
- reduction of the risk of spilled fuel catching fire.

Analysis of emergency landings of aeroplanes with retracted undercarriages has not fully confirmed the theoretical advantages of the foam blanket. Neither is there any evidence to prove that laying the blanket has any psychological advantages for the pilot.

When an assessment is made of the possibility of laying a foam blanket, besides the theoretical advantages, consideration should be given to a whole range of operational issues, affecting either the aircraft engineering, or the airport and its operational problems. As far as the aeroplane is concerned, the extent of damage to, or failure of, its undercarriage or other damage is important. Consideration should also be given to the pilot's experience, weather conditions, particularly the visibility, and the runway equipment. It is not always possible for the pilot to use a preferred runway, as shown by the accident at Amsterdam with the El Al Boeing 747 Freighter.

When an evaluation is made of the possibilities of the airport using the foam blanket, the factors include the number of runways, runway length on which the blanket is intended to be laid, traffic density, and consequences of closing the runway for several hours or days, or cleaning and repair of the runway after the disabled aeroplane removal. Special equipment should be available for runway foaming. Taking into account its price and the rarity of such an event, not every airport

carries a supply of foam. It is usually convenient to equip one airport in a given region. When a selection is made of which airport, besides the operational factors, consideration should be given also to the characteristics of the airport surroundings as far as the hospital capacities, approach communications, etc. are concerned. Extrication devices must be available, together with cranes and facilities to repair aeroplanes. Airports that do not have special equipment available should not try to provide runway foaming. The rescue and fire fighting vehicles should be constantly prepared for an intervention and have available the specified quantities of extinguishing agents. The captain of the aeroplane with the emergency may be forced by circumstances to execute the landing before runway foaming is finished, and the rescue and fire fighting vehicles should be prepared for this.

Table 19-6 Water and protein foam liquid requirements for runway foaming

Parameter	Malfunction nose wheel	Wheels up landing			
		2-engine propeller	2-3 engine jet	4-engine propeller	4 engine jet
Width of pattern	8 m	12 m	12 m	23 m	23 m
Length of pattern	450 m	600 m	750 m	750 m	900 m
Runway area covered	3 600 m ²	7 200 m ²	9 000 m ²	17 250 m ²	20 700 m ²
Water required	14 400 l	28 800 l	36 000 l	69 000 l	82 800 l
Protein foam required					
3% type	432 l	864 l	1 080 l	2 070 l	2 484 l
6% type	864 l	1 728 l	2 160 l	4 140 l	4 968 l

(Source: Airport Services Manual: Part 1 - Rescue and Fire Fighting)

It is also necessary to assess the time which is available for foaming. Even with good organisation, the preparation and laying of the foam blanket will take one hour or more. If the aeroplane has enough fuel, it may fly off, reduce the mass and thus also the risk of a subsequent fire.

Weather conditions also have an effect upon the quality of the foam blanket. At high temperatures and overheated runways, the foam may decay more quickly. Conversely, at temperatures below

zero, the water from the decaying foam freezes and considerably reduces the braking effect. It is not possible to lay the foam blanket in heavy rain or snow.

Foaming may be requested by the aircraft captain or by a representative of the air carrier. However, they should have sufficient flight and operating experience to consider in advance all these points, and also other factors, which have an effect on that decision.

The touch-down point of an aeroplane with retracted undercarriage on the runway is, in the majority of cases, 'longer' by 150 m to 600 m than normally, as a consequence of a more significant 'ground effect'. The width, length and manner of runway foaming should correspond to the type of aircraft, to the kind of undercarriage failure and to the requirements of the pilot in command. In bad visibility, when it is difficult to distinguish where the blanket begins, it should be marked in an agreed way.

After foaming, it is necessary to leave the foam 'resting' for 10 to 15 minutes, so that the runway surface may dampen. However, the foam must not lie on the runway for a very long time, for example, more than 2 1/2 hours, particularly in summer, since water from the blanket runs out and the foam dries up. The foam blanket thickness should be approximately 5 cm. Table 19-6 gives water quantities required for the runway foaming.

19.7 POST EMERGENCY OPERATIONS

After the airport emergency is finished, the operations of the rescue and fire fighting units should be organised in such a way that evidence is not destroyed which may be pertinent to the subsequent investigation. Ambulances and rescue and fire fighting vehicles should not cross the track that the aeroplane left during the emergency landing, but they should, if possible, move along and to the side of it.

The state aviation authority should be immediately advised about the aeroplane accident, and a committee should be appointed to investigate it. Investigation of the accident usually requires several hours or even days during which a plan for the removal of the aeroplane may be established and the required equipment may be provided. Until the committee terminates the investigation and gives approval, the wreck of the aeroplane must not be moved. The only exceptions are when the wreck creates an obstacle and is a serious danger to air traffic. If the wreck is blocking the runway end, consideration should be given to the possibility of operation on a shortened runway.

The disabled aeroplane usually disrupts the regular operation of the aerodrome, and therefore the airport administration requires its removal as soon as possible. The damaged aeroplane is the

property of the flight operator and the insurance company. The airport administration may in no way interfere with the wreckage, otherwise it would expose itself to the possibility that it will be accused of further damaging the aeroplane as a consequence of unauthorised and unprofessional manipulation of the aeroplane. Therefore the management of the disabled aircraft removal shall be in the exclusive competence of the flight operator and the insurance company, with whom the airport administration closely co-operates. The removal of small aeroplanes is a relatively simple matter. Upon agreement with the proprietor, the airport administration may undertake to do it.



Figure 19-9 Post emergency requires close co-operation with local companies who own heavy-duty mechanisms (Photo J. Mach)

The recovery of large passenger aeroplanes is technically and financially demanding (Figure 19-9). It is often dangerous, and requires special equipment and knowledge in order that it should not be damaged. The airport administration usually has not the necessary equipment and mechanisms for such an activity. A specialist team shall be established for the removal of the disabled aeroplane, to which representatives of the operator, insurance company and manufacturer shall be appointed. The specialist group shall elaborate a plan for the removal of the aeroplane, which comprises in particular the following:

- a list of the required equipment, personnel and schedule of the activities
- preparation of the access roads for heavy-duty equipment

- surveying the place of accident
- safeguarding the place of accident
- manner of leasing the special equipment and mechanisms
- data and recommendations of the manufacturer
- defuelling, and draining of the oils and other liquids from the aeroplane.



Figure 19-10 Lifting of aircraft by special air bags
(Source: Vepro company)

In order that the disabled aeroplane can be removed, it is usually necessary to lift it, insert an emergency undercarriage under it, and then remove it on a temporary strengthened surface. Special air bags are most often used for lifting aeroplanes (Figure 19-10). The air bags are inserted under the wings, and the front and rear parts of the fuselage so that the aeroplane stability can constantly be ensured. Lifting is controlled by gradual inflation of the individual bags from a compressed air generator.

It is usually possible to lease the heavy-duty mechanisms required for removal of the aeroplane, such as cranes, lorries and machines for treatment of the access roads from local companies. The airport administration should have available the information about readily obtainable particular kinds of heavy-duty plant.

The other group shall be formed of special equipment usable for all types of aircraft. These are hydraulic lifts, air bags, compressors, lighting equipment, etc. Since it would be uneconomic to

have such equipment at every airport, the IATA International Airlines Technical Pool programme was established, by means of which the special equipment is made available. The equipment may be used by the member airlines, and by the non member airlines for a charge. The equipment is kept at 11 airports (Bombay, Chicago, Honolulu, Johannesburg, New York, London, Los Angeles, Paris, Rio de Janeiro, Sydney, Tokyo). The equipment is laid on pallets and may be supplied to any airport within 10 hours, and in the majority of events, the time does not exceed 5 hours.

19.8 EMERGENCY SERVICES AND ENVIRONMENT PROTECTION

At the majority of airports, the fire fighting unit is charged even with interventions at ecological accidents or incidents, and sometimes with a preventive activity in connection with environmental protection. An aircraft accident and an intervention by fire fighting units may result in an ecological disaster. Therefore the emergency plan of the airport must address the issues of environmental protection during the training of the rescue and fire fighting unit and during the intervention.

A long term goal is to substitute harmless or biologically degradable material for extinguishing agents that adversely impact the environment. Some types of halons which deplete the ozone layer can be substituted by some complementary extinguishing agents. More than 50 airlines participate in the HAL project, which is resolving the issues of a 100% recycling of halon gases from fire-extinguishers. The companies Rosenbauer (Austria), Sabo (Italy) and Sicli (Switzerland) are involved in a research project called Eureka for substitution of the foam forming surface-active agents on the base of fluorine, which impair the environment, by other material, equally efficient but ecologically harmless.

Similarly, during the training of fire fighting units, attention should be paid to possible pollution of the Earth's atmosphere and underground waters. During free combustion of kerosene, thick black smoke is created which may deplete the ozone layer. In the training centre for rescue and fire fighting units at Stansted Airport (UK), aircraft kerosene has been substituted by natural gas which is combusted in a special ring. The training polygon in the Birmingham airport complies with the stringent criteria of environment protection. All the facilities designed for training (an aircraft fuselage, undercarriage and engine, steel wall) are situated in an impermeable basin, covered by a layer of gravel. Extinguishing agents and the remains of kerosene are drained off from the basin and treated. Kerosene is recycled for the training.

19.9 FINAL THOUGHTS

Besides the training and equipment of the airport rescue and fire fighting units, the quality of an airport fire emergency service may be further enhanced by improved cabin crew emergency procedures training and an increase in the fire resistance of the aircraft. The issues of aircraft construction, although very important with regards to the fire emergency service, are not a subject of this book.



*Figure 19-11 Passenger safety can be enhanced by cabin crew emergency procedures training
(Photo: M. Kvapil, CSA Training Centre)*

Every flight operator is obliged to provide the passengers with a briefing on safety. The majority of them consist of a presentation given by the cabin staff, instructional cards which the passengers have available, or with a video film. It is questionable whether under the conditions of a real accident, a passenger will be able to open the emergency exit on the basis of such a briefing. Many passengers would be uncertain of how to open the door, asking themselves questions like: ‘Which direction is it to be opened, inwards or outwards?’ ‘What strength is to be exerted for turning the

handle?', and so on. The crew have to make themselves perfectly familiar with the emergency equipment of an aircraft during their training in emergency procedures. The passengers ought to have a similar opportunity in 'safety centres' established at airports. The emergency equipment of aircraft mostly used by the airport may be installed in those safety centres. The passenger designated to sit next to the emergency exit could 'touch' and try to open it. The question is what attitude the airlines may adopt with regards to the idea of safety centres. Some may think that they could emphasise the fact that accidents happen from time to time, and discourage a percentage of the passengers from using air transport.

20

ENVIRONMENTAL CONTROL

Tony Kazda, Bob Caves and Milan Kamenický

Inscription on the gate of an American airbase:

'Pardon Our Noise it is the Sound of Freedom'.

20.1 BACKGROUND

In the relationship of air transport with the environment, a number of conflicts have been identified. Air transport clearly has a negative effect on the environment. In comparison to other means of transport, however, the local environmental impact is taken only on the surroundings of the airport whereas with road or rail transport the area along the whole route is affected by noise and gaseous emissions. In compensation for the environmental disbenefits, air transport supports economic growth, as indeed do the other modes. A medium size airport provides directly several thousand jobs and indirectly tens of thousands. It is 'an economic catalyser' for its catchment area.

One of the basic human rights is the right of an individual to a healthy environment. From this point of view air transport has been the subject of negative criticism. In the last 15 years the standard of living of people in the developed countries has increased rapidly. The real income has increased and this opened up more free time and the wealth to use it actively. People use air transport more and more for holidays. Air transport has at the same time contributed considerably to further economic growth. As wealth increased, sensitivity to the quality of the environment grew even faster. In other words, after people had achieved their fundamental goals, they became more sensitive to their environment. The class of people with a high standard of living use air transport more and more, while at the same time more and more criticising its negative

consequences. A similar development has also been taking place recently in the former Eastern Block countries.

The ministers of transport of the ECAC states have concluded that the environment is one of the decisive factors in setting the future limits of airport expansion. The main target of ECAC strategy for airports is the improvement of the potential capacity of European airports and air space while preserving the standard of safety and respecting the requirements of the protection of the environment, taking into account the forecast growth of air transport in the ECAC states.

The basic strategy for dealing with the environmental issue in accordance with the ECAC conclusions can be characterised for the airports as follows:

To specify the maximum capacity in the remote future in terms of the environmental carrying capacity as well as the physical capacity of the airport site.

In line with ACARE1 2020 Strategic Research Agenda - High Level Target Concepts – air transport should be ultra green in the future. Goals set by ACARE – with a 2020 deadline – include a 50% reduction of carbon dioxide CO₂ emissions through a drastic reduction of fuel consumption, an 80% reduction in emissions of oxides of nitrogen NO_x and a 50% cut in external noise from the 2006 level. It also aims for a ‘green’ product life cycle design covering manufacturing, maintenance and disposal. The local council for London Stansted airport has rejected an application to increase the capacity from 24 to 35 mppa on the grounds that it would increase the difficulty in meeting these global warming targets.

The impact of an airport on the environment must be based on an Environmental Impact Assessment (EIA) study. After an EIA has been performed by a specialised agency, and considered by the responsible state administrators after deliberation with other affected state administration bodies, a process of public hearings takes place with the affected communities. The length and scope of this process depends on the character of the project and character of the surrounding area, e.g. it will differ for large urban communities, compared with for nature conservation areas or low quality uninhabited areas, the latter being hard to find in developed countries anywhere near a centre of population. The EIA must, above all, be based on a deep knowledge of the effected area, the character of other adjacent areas, environmental carrying capacity and restrictions, and on the knowledge of land use and compatibility planning of the site and in the communities in the surroundings of the airport.

Depending on the situation, any of the impacts could be the deciding factor in determining the outcome of an EIA, but noise is the factor that normally gets the most attention. Therefore the first part of this chapter deals with noise. It then deals with the issues of exhaust gases, ground water

1 ACARE - Advisory Council for Aeronautics Research in Europe

and bird control. The issues of ground water and soil protection are also dealt with in Chapter 10 - Aircraft Refuelling, Chapter 18 - Airport Winter Operation and Chapter 19 - Airport Emergency Services.

A list of factors related to air transport that have a negative effect on the environment is given below, divided into seven groups. The impact of the airport on the environment can be compared to the impact of a medium size or large industrial enterprise, with an additional special impact from the air transport operation.

Noise of aircraft

- noise of aircraft in the vicinity of the airport
- tests of aircraft engines
- supersonic boom
- noise of aircraft en- route

Air pollution in the vicinity of airports

- emissions of aircraft engines
- emissions from the operation of vehicles on the airport
- emissions from transportation to and from the airport
- emissions from other sources on the airport (e.g. heating plant)

Factors with a global impact

- long distance transfer of air pollution (e.g. acid rains)
- greenhouse effect - contribution to global warming due to deposition of carbon dioxide in or near the tropopause
- depletion of ozone layer
- contrails global 'darkening'

Airport construction

- excavation of soil
- soil erosion
- interference with ground water channels and rivers
- impact on flora and fauna
- visual intrusion

Contamination of waters and soil in the vicinity of airports

- imperfect treatment of waste waters
- leaks of oil products
- de-icing of airport pavements and aircraft

Waste management

- storing and disposal of dangerous substances used in maintenance and repairs of aircraft
- waste from the airport operations and from arriving aircraft

Aircraft operation including the accidents or incidents

- wake vortices and their impact on the neighbouring dwellings
- blue-ice phenomenon (it is created when toilet tanks or drain tubes on an aircraft leak)
- accidents or incidents of aircraft with hazardous cargo
- emergency procedures connected with aircraft de-fuelling
- other negative effects to the environment connected with an aircraft accident (e.g. fuel leakage, leakage of extinguishing substances, aircraft safety of the communities around airports)

20.2 NOISE

(Author: Milan Kamenický, Bratislava, Slovakia)

Noise has long been a problem around airports, Newark being closed in 1952 after demonstrations about it. Reaching an accommodation between the industry and the local communities has required progress on three fronts. Planners have needed to understand the attitude of the communities for whom they are responsible, the industry has attempted to ensure that the best feasible levels of technology are being used, and airports have had the uncomfortable task of trying to reconcile the resulting situations by mitigating the impacts.

20.2.1 Characteristics

Sound is a mechanical wave motion spread from a source. It can move through gases, liquids and elastic solids and it is connected with a transfer of energy. The speed at which a sound moves depends on the medium through which it moves.

This is the physical definition of sound. Sound can be also defined as a change of the pressure that

is received by the human ears and interpreted as a sensation by the brain. The frequency could be at the minimum 20 and at the maximum 20 000 cycles per second, or Hertz (Hz). If a sound wave's frequency is higher than 20 000 Hz, it is called ultrasound. If it is lower than 20 Hz, it is called infrasound.

What is the difference between sound and noise? Clearly it cannot be the loudness only, although an aircraft can be so noisy as to injure the ear if one is too close without hearing protection. A mosquito at night-time can be more than enough to spoil a good night's sleep. Instead of considering only the physical characteristics of noise, it is possible to think of it as unwanted sound. This has certain implications.

Because noise is unwanted sound, it is closely connected with the feeling of annoyance.

Noisiness is related to the loudness of a sound, which in turn depends on when and where it occurs. Mosquitoes cause less annoyance during daytime, at least from the point of view of noise. If noise becomes loud enough, the primary concern will be the risk of hearing impairment, not the annoyance.

Noise is a specific form of pollution. It is more a sociological element than an economic one. Too loud a sound or one that is generated too often, in an improper time, in an improper place or in an improper situation is designated as noise. Aircraft noise has a disturbing effect in particular on the inhabitants in the vicinity of aerodromes and under arrival and departure tracks.

Social research has shown that people differ enormously in their attitude to noise, but that their annoyance is related to both the noise intensity of a flight and the number of flights they hear. This led to the development of noise indices to represent the impact on a community, each country developing its own indices, but most containing terms reflecting both loudness and frequency.

Modern aircraft technology has considerably reduced the noise from the engine sources. The area on the ground affected by a given level of noise from modern jets is approximately 5 times smaller than that affected by the jets in 1960's. This positive trend will be in future partially diminished by overall growth of traffic and aircraft movements at major airports. However, it is important that, with the withdrawal of the noisiest aircraft from operation, the maximum noise levels for individual movements will be reduced. These peak individual noise events are one of the main reasons for complaints among the communities around airports.

Noise around airports can be controlled in four ways. The first way is to reduce the noise at source through improved technology and aircraft noise certification to ensure that the available technology is employed. This is not dealt with further in this book. The second way is to control the aircraft operational procedure. This includes optimization of flight procedures and distribution

of movements between runways. The third way is by limiting operations by type and time of day. The process of noise monitoring in selected points of the airport vicinity is an important part of the optimization of operations. The fourth way is land use and compatibility planning around the airports, particularly with regard to urbanization zones.

These measures comprise the so-called ‘balanced approach’ promoted by ICAO. An approach to noise control on a system basis in all of the four areas should ensure an acceptable noise load on the inhabitants in the vicinity of aerodromes and under the arrival and departure routes.

20.2.2 Descriptors Used for Aircraft Noise Rating

Sound pressure is the basic metric for assessment of noise. Sound pressure represents time fluctuations of pressure around its static value. In a common air environment, static pressure represents barometric pressure. For common sounds, the range of acoustic pressure values is approximately from 2×10^{-5} Pa up to 20 Pa. A value of 2×10^{-5} Pa is the weakest sound to be noted by the human ear – so called threshold of audibility. That value is 5×10^9 times smaller than the normal value of barometric pressure and would be created by a deviation of the tympanum over a distance smaller than the diameter of one atom. The values of acoustic pressure of common sounds are relatively small but their range is very big ($1:10^6$). Therefore, since sound is perceived by a human being, the Pascal is not very convenient for measuring it. Further, this is also not convenient because human perception of sound is on the basis of Webber-Fechner’s physical law:

When physical intensity of the tone ‘*i*’ of the given frequency grows in a geometric series, its subjective effect ‘*h*’ on the human ear (tone noisiness level) increases approximately only in an arithmetic series. An approximately correct mathematical expression of tone intensity dependence on its noisiness level has the form:

$$i = k \cdot a^h$$

where ‘*k*’ and ‘*a*’ are constants.

A logarithmic value, the so called level, is used for expressing the sound pressure and other acoustic quantities. The sound pressure level is expressed with the unit of dB, called decibel

$$L_p = 10 \cdot \log(p^2/p_0^2)$$

where the quantities with a subscript zero are reference quantities related to the threshold of audibility. The reference for sound pressure in air is 2×10^{-5} Pascals (Pa), which is equivalent in the decibel scale to 0 dB. By converting sound pressure in Pascal to decibels, a scale spanning $1:10^6$ is conveniently reduced to 1:120. Figure 20-1 indicates typical sound pressure levels for

‘everyday’ incidents.

Physically doubling the sound pressure means to increase the level by 6 dB, while a ten-fold increase means to increase it by 20 dB. On the other hand, if the sound pressure is reduced by 50%, the level has been reduced by 6 dB, and a reduction to 1/10 corresponds to a decrease of 20 dB.

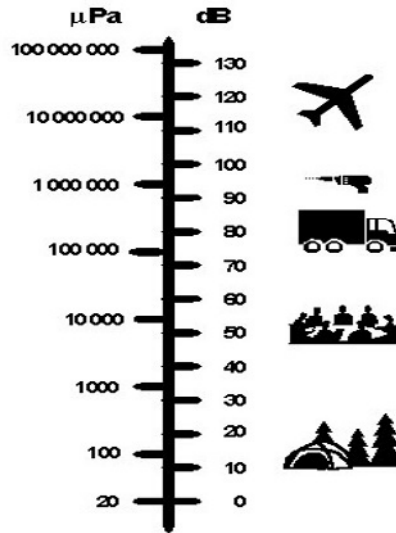

Figure 20-1 The relationship between Pascals and decibels

It was mentioned above that the range of normal human hearing is approximately 20 Hz to 20 kHz. However, human hearing is not linear with respect to the sound frequency. If there are two signals with a different frequency but with the same level they are perceived differently in terms of noise. In other words, sound is frequency dependent. Further, this dependence also depends on the level. This complicated phenomenon can be clarified by curves of equal loudness, called Fletcher-Munson's curves (Figure 20-2).

By reversing these curves we get the frequency dependence of sound sensitivity. On the basis of these curves, weighting curves were created and the corresponding weighting filter used for a sound level meter. The sound level meter evaluates sound in all frequencies that are perceived by human hearing. Three basic weighted curves A, B, and C, the most used being the A weighted curve and filter, were created in a way that all three chosen curves represented the same loudness of 40 Phon.

Other weighted curves were also designed; of which the most used for evaluating airport noise is D. This curve was designed for evaluating sound events that occur when the airplanes overflies the measuring point. This is to capture the more disturbing part of this noise as perceived by a human being and is the Perceived Noise Level (PNdB).

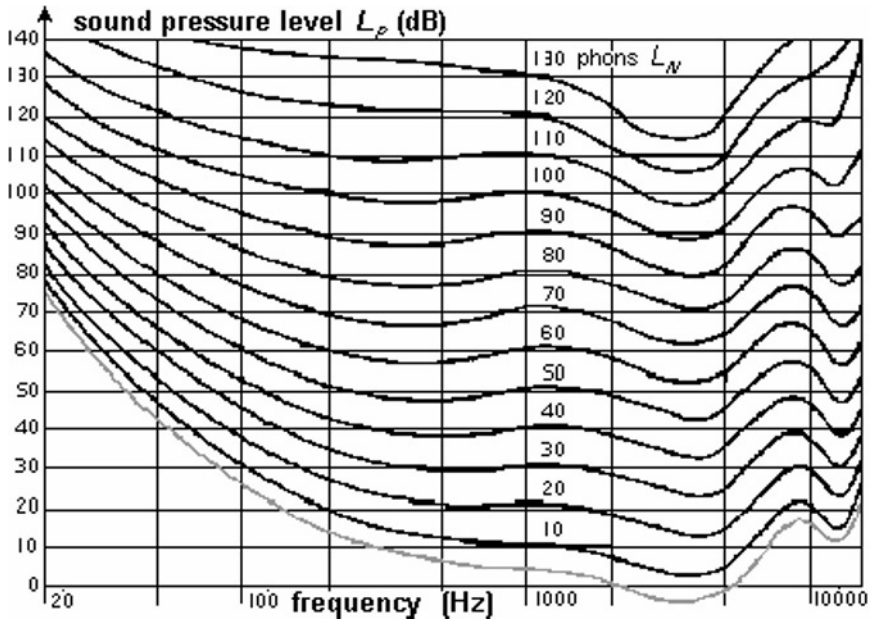

Figure 20-2 The Equal Loudness Curves

The energy content of the sound is a fundamental aspect of risk assessments of hearing impairment. The Root Mean Square (RMS) is a special kind of mathematical average value which is directly related to the energy content of the sound. It is one of the most important and most used measures, the sound pressure level being defined from an RMS value of sound pressure.

Loudness is not only a function of the frequency and the level of the sound, as has already been mentioned, but also of the sound duration. The risk of hearing impairment depends not only on the level of the sound, but also on the amount of sound energy entering the ear. For a given sound level the amount of energy entering the ear is directly proportional to the duration of exposure. Sounds of short duration are perceived to be of a lower level than steady continuous sound of the same level. To assess the potential for damage to hearing from a given noise environment, both the level and the duration must be taken into account. However, if the level is very high the duration is irrelevant. The hearing impairment will occur almost instantly with a sound pressure level over 120 dB(A). The influence of time as a factor of the noisiness effect is expressed by the

quantity Equivalent Continuous Sound Level, called L_{eq} .

The equivalent continuous A-weighted sound level, L_{Aeq} , equals the constant A-weighted sound level whose acoustic energy is equivalent to the acoustic energy of a fluctuating A-weighted sound over some time interval.

The mathematical formulation is:

$$L_{Aeq} = 10 \times \log \left(\frac{1}{T} \int_0^T \left(\frac{p_{A(t)}^2}{p_0^2} \right) dt \right)$$

where:

T duration

$p_{A(t)}$ the actual A-weighted sound pressure

p_0 the reference pressure.

This is similar to the RMS value. Although they both express an equivalent constant signal containing the same amount of energy as the actual time-varying signal itself, they cannot be substituted for one another. The L_{eq} expresses the linear energy average, while the RMS value expresses a weighted average where more recent events have more weight than older ones.

The equivalent continuous level is not the only parameter that could be used for energy content assessment. An alternative parameter is the Sound Exposure Level (L_{AE}), also called the Single Event (Sound) Exposure Level, often known for short as the SEL (Figure 20-3).

The L_{AE} is defined as the constant level acting for one second which has the same amount of acoustic energy as the original sound. The L_{AE} is the L_{eq} normalised to a one second interval. L_{AE} measurements are often used to describe the noise energy of a single event such as an aircraft fly-over. L_{eq} is normally used to integrate the succession of single events over a longer time period.

In the majority of countries, descriptors for aircraft noise issue from mathematical quantities that are defined in the standard ISO 3891 ‘Acoustics, Procedure for describing aircraft noise heard on the ground’. An equivalent to that norm in Great Britain is the BS 5727/1979 standard. In this standard two basic quantities are recommended for evaluation of the aircraft noise. They are an Equivalent Perceived Noise Level L_{PNeq} and an Equivalent A-weighted Sound Level L_{Aeq} for a specified period. The standard gives an exact description of the transformation of the measured quantities to those used for evaluation.

An approximate value of Effective Perceived Noise Level - $L_{EPN (approx.)}$ (EPNL), acquired by measuring D-weighted sound level, which expresses the total noise effect generated by an aircraft

flight over the place of observance, or Sound Exposure Level L_{AE} , acquired by measuring of A-weighted sound level, is recommended as the primary quantity for determining the evaluation descriptors.

EPNL - $L_{PN_{eq}}$ is determined by time averaging Perceived Noise Level - L_{PN} . PNL is derived from a quantity: perceived noisiness (PN). The perceived noise level is a calculated single number based on known levels of people's hearing response to fixed-wing jet aircraft flyover noise. For determining Perceived Noise Level, it is necessary to make an octave or a third-octave analysis of the sound signal.

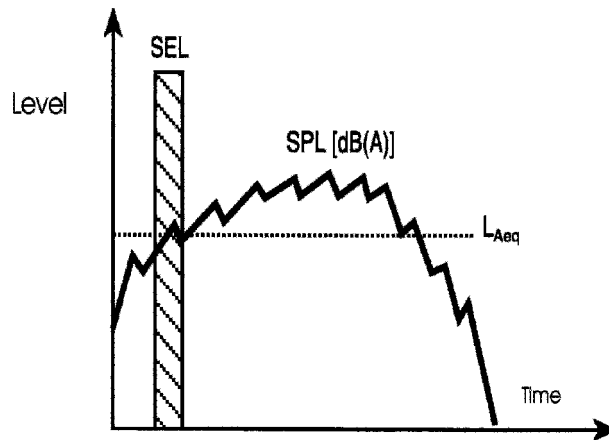

Figure 20-3 *The relationship between sound pressure level (SPL), L_{Aeq} and SEL*

The unit of perceived noise is PNdB. The method of computing it is described in detail in ISO 3891. Aircraft noise ranking by means of this descriptor is relatively complicated and requires a multi-spectral analyser working in real time. For normal purposes, an approximate effective perceived noise level $L_{EPN (approx)}$ is used, together with an approximate perceived noise level $L_{PN (approx)}$. The following approximate relations are valid

$$L_{PN} = L_D + 7 \text{ dB}$$

$$L_{PN} = L_A + 12 \text{ dB.}$$

At present a revision of the ISO 3981 standard is being carried out. There are expectations that aircraft noise need only use an A-weighted sound level and descriptors derived from it, such as sound exposure levels, equivalent and A maximum sound level.

The latest amendment of the ISO 3981 standard is also dealing with:

- requirements for installation and operation of air transport noise continuous measuring equipment
- recommendations for noise data recording from aircraft operations and individual aircraft movements
- air transport noise descriptors requirements
- noise monitoring protocols requirements
- determination of uncertainties during noise monitoring.

The latest amendment of the ISO 3981 standard corresponds to the new standard IEC 61672-1 which describes technical characteristics and requirements for air transport noise measuring equipment.

However, all these metrics are only poor indicators of people's actual disturbance from noise events, this being indicated by the poor correlation of the number of complaints with the noise contours generated by the metrics. They do not adequately treat problems of noisy peak operations or noise at night, particularly in the period before waking, nor for the whining tone of the latest generation of engines, despite being corrected for the ear's sensitivity to different frequencies. There is at least a suspicion that noise complaints are actually a surrogate for fear of accidents, instanced by complaints being made even though the aircraft has been seen but not heard.

20.2.3 Evaluation of Noise in the Vicinity of Airports

Aircraft noise is evaluated in different ways in individual countries. In the majority of countries, however, only sound events that are connected with aircraft movement or other aircraft activity such as engine tests and taxiing are evaluated. Such a sound event will increase the respective acoustic indicator that describes aircraft noise against an acoustic background.

Since 1992, Great Britain has used the equivalent A sound level L_{Aeq} from sound events between 0700 and 2300 hours as the main noise evaluation tool, supplemented by a night-time L_{Aeq} , usually over the busiest three month period.

In Germany the procedures for assessing the noise load rating in the airport vicinity are elaborated in detail. They reflect experience from long-time monitoring of aircraft noise. The assessment is carried out on the basis of the Act on Protection against Aircraft Noise and the DIN 45631 standard. Equivalent continuous sound level determined by sound events from air transport in a time period of 6 months is the evaluation descriptor used. In 2007 a new amendment of the Aircraft Noise DIN 45631 standard was adopted where the equivalent A sound level L_{Aeq} is used for the noise evaluation, except during the night period when the maximum A sound level L_{Amax}

must be used.

Besides using the equivalent continuous level, the DIN standard recommends, on the basis of an analogy with ISO 3891 standard, also measuring and evaluating equivalent A-weighted sound level. Long-run equivalent continuous level is computed from measured A-weighted sound levels corrected to equivalent pressure levels over one second, the result corresponding to sound exposure level. The equivalent sound level is derived for the 6 month period for which the traffic level is highest for the airport in question. This rating level is used for comparison with noise levels from other kinds of transport and industry. In addition, the DIN standard recommends the use of the maximum A-weighted sound level measured with a time constant as an auxiliary descriptor.

In Norway two quantities are used for aircraft noise evaluation at airports. Equivalent continuous A-weighted sound level averaged over 24 hours with additional weighting for night and evening flights, similar to CNEL and L_{AeqDN} in the USA as described below, and maximum A-weighted sound level in one week. A third A-weighted sound level, maximum level, is also monitored for a period of time. Furthermore, equivalent level is averaged for the whole week with variable additional weighting of flights during Saturday and Sunday.

In France a quantity ‘Indice psophique’ R is used for airport noise evaluations. It is computed as a sum of noise peaks of all aircraft movements, while perceived noise level PNL is measured. During computation and evaluation, night flights between 2200 and 0600 hours are penalised with a value of 10 dB. For computation the following relation is used:

$$R = 10 \cdot \log(\Sigma 10^{L_{PN}/10} + 10 \cdot \Sigma *LPN^{L_{PN}/10}) - 32$$

In the Netherlands a ‘Rating Index’ B is used. Maximum A sound levels of each sound event caused by air transport are used. The following equation determines the evaluative index B:

$$B = 20 \cdot \log(g_i \cdot 10^{L_{Amax}/15}) - 157 \quad (10)$$

$g_i = 1$ for interval of 8-18 hours; 2 for 18-19 hours; 3 for 19-20 hours; 4 for 7-8 and 20-21 hours; 6 for 21-22 hours; 8 for 6-7 and 22-23 hours, 10 for 23-6 hours.

In Switzerland the Noise and Number Index NNI(A) is used for aircraft noise rating. It is an analogy to NNI that used to be used in Great Britain, but it is derived from maximum A-weighted sound level measurement (with a SLOW time constant) of sound events caused by air transport. For computation only those sound events whose maximum levels exceed 68 dB(A) between 0600 and 2200 hours are taken into consideration. Besides the averaged maximum sound level of all considered sound events, the average daily number of movements of aircraft is also taken into account in computation. NNI(A) is determined by means of the following relation:

$$NNI(A) = (L_{Amax})_{en} + 15 \cdot \log(N) - 68$$

where:

N n/365

n number of operations 0600-2200 hours at which L_{Amax} exceeds 68 dB(A).

In the former USSR air transport noise is rated by maximum A-weighted sound level and equivalent A sound level.

In Slovakia the equivalent A sound level L_{Aeq} and the maximum A sound level L_{Amax} with a SLOW time constant are used for noise evaluation. In the Czech Republic air transport noise is evaluated by equivalent A sound level.

The existing European regulations do not solve the long-run issues of airport noise evaluation. Regulations ES 80/51 and ES 83/206 determine only maximum limits for subsonic aircraft, similar to those from aircraft certification. There are discussions about implementation of a unified evaluative quantity Weighted Equivalent Continuous Perceived Noise Level (WECPNL). In substance, it is the Equivalent Perceived Noise Level - L_{pNeq} recommended in ISO 3891, but with penalties for aircraft movements in the evening from 1900 to 2200 of 3 dB and at night from 2200 to 0600 of 10 dB. WECPNL is determined for a time range of 24 hours. That descriptor is at present recommended also by ICAO.

In the USA the issues of noise have been dealt with in detail since 1950's. Several methods have been proposed and several rating quantities have been recommended during the development. In the majority of cases they issued from the US Environmental Protection Agency (EPA) recommendations. Indicators for general evaluation of noisiness in the environment were adapted to aircraft noise evaluation. At present several indicators are in use.

The Noise Exposure Forecast (NEF) is an improved older quantity, the Composite Noise Rating (CNR), which is an analogy to NNI. NEF is derived from the effective perceived noise level L_{EPN} for individual noise events caused by aircraft movement. Noise events caused by a movement at night are multiplied by a coefficient of 16.67. For NEF = 0, a concept of 'threshold of perceived aircraft noise' was introduced. The NEF is now used to determine noise load from measurements, but was originally calculated from predictive methods.

Equivalent A-weighted sound level for Day – Night - L_{AeqDN} is another quantity used in the US. It is used for general evaluation of noise load in the environment. It is derived from a 24-hour evaluation of equivalent level. Levels for day are multiplied by a coefficient of 0.625 over 15 hours and those for night by a coefficient 0.375 over 9 hours. In addition, levels for night are penalised by 10 dB. When an evaluation is made of aircraft noise, this quantity comes from

particular sound events, which are rated by A-weighted sound exposure level (L_{AE}). Simplified computation of L_{AeqDN} may be done by means of the following relation:

$$L_{AeqDN} = (L_{AeqD} - 1.8 \text{ dB}) + (L_{AeqN} + 5.2 \text{ dB})$$

Community Noise Equivalent Level – CNEL is an improved version of L_{AeqDN} used predominantly in the state of California. It is also derived from 24-hour averaging of A sound levels. For aircraft noise however it is modified relative to L_{AeqDN} so that the sound events between 1900 and 2200 are in addition penalised by 3 dB. When CNEL is determined, it is derived, as with L_{AeqDN} , from A-weighted sound exposure levels (L_{AE}).

In special cases, daytime equivalent A-weighted sound level evaluated from 0700 to 2200 hours and a night time one evaluated in a period of time from 2200 to 0700, are also used.

It may be stated that from the viewpoint of evaluation of the noise caused by aircraft operation, there is no consistent international regulation that would be implemented into the legislation of particular states. In every state the evaluation is made on the basis of national regulations, recommendations or laws, though some national regulations do issue from the standard ISO 3891. However, some states have calibrated their own descriptors satisfactorily against surveys of community annoyance.

20.2.4 Land Use and Compatibility Planning

In the majority of states there is an effort to provide healthy and quality environment, particularly in the residential areas and for noise sensitive activities such as schools, hospitals and recreational zones. Planning of built-up areas in the airport vicinity is an efficient instrument for preventing complaints of inhabitants in the future, as long as the plans can be reinforced. States are then able to prevent additional settlement of new inhabitants in the noise-affected zones in the airport vicinity. However, in the majority of cases, there is a question over the limitations of the owners' rights to their property and therefore it is an especially sensitive area of legislation. For that reason there is an effort to solve disputes by an agreement in terms of various forms of compensation or repurchase of the estate rather than by expropriation of the estate even if the right of expropriation exists in the legal system.

In **Germany** the Act for Protection against Aircraft Noise determines also the limits that restrict 2 noise zones in the airport vicinity:

Zone I – equivalent noise level is higher than 75 dB(A)

Zone II - equivalent noise level is lower than 75 dB(A), but higher than 67 dB(A).

The act specifies which activities may be allowed in the respective zone, e.g. there is a strict prohibition on building schools, hospitals and new residential buildings in both of the zones.

Noise limits according to the new amended standard are also defined for two zones but, for airports, four different cases are specified with respect to the type of an airport and its development:

1. New or, by a re-construction, considerably expanded civil aviation airports

Daytime limits:

Zone 1 $L_{Aeq} = 60$ dB(A), Zone 2 = 55 dB(A)

Night operation limits:

- a) Till 31.12.2010, $L_{Aeq} = 53$ dB(A), the $L_{Amax} = 57$ dB(A) could be exceeded 6 times during night
- b) From the 1.1.2011, $L_{Aeq} = 50$ dB(A), the $L_{Amax} = 53$ dB(A) could be exceeded 6 times during night

2. Existing civil aviation airports

Daytime limits:

Zone 1 $L_{Aeq} = 65$ dB(A), Zone 2 = 60 dB(A)

Night operation limits:

$L_{Aeq} = 55$ dB(A), the $L_{Amax} = 57$ dB(A) could be exceeded 6 times during night

3. New or, by a re-construction, considerably expanded military airports

Daytime limits:

Zone 1 $L_{Aeq} = 63$ dB(A), Zone 2 = 58 dB(A)

Night operation limits:

- a) Till 31.12.2010, $L_{Aeq} = 53$ dB(A), the $L_{Amax} = 57$ dB(A) could be exceeded 6 times during night
- b) From the 1.1.2011, $L_{Aeq} = 50$ dB(A), the $L_{Amax} = 53$ dB(A) could be exceeded 6 times during night

4. Existing military airports

Daytime limits:

Zone 1 $L_{Aeq} = 68$ dB(A), Zone 2 = 63 dB(A)

Night operation limits:

$L_{Aeq} = 55$ dB(A), the $L_{Amax} = 57$ dB(A) could be exceeded 6 times during night

Note: *Equivalent noise level daytime limits are specified for a period 06h00 and 22h00.*
 Equivalent noise level night limits are specified for a period 22h00 and 06h00.

Norwegian legislation determines four protective zones for equivalent and maximum levels.

1. zone - $L_{Aeq} = 55 - 60$ dB(A), $L_{Amax, DAY} = 85 - 95$ dB(A)

2. zone - $L_{Aeq} = 60-65$ dB(A), $L_{Amax, DAY} = 95-100$ dB(A)

3. zone - $L_{Aeq} = 65-70$ dB(A), $L_{Amax, DAY} = 100-105$ dB(A)

4. zone - $L_{Aeq} > 70$ dB(A), $L_{Amax, DAY} > 105$ dB(A)

In particular zones it is exactly determined under which conditions what structure might be realised.

Austria deals with these issues by legislation as in Germany. Three zones are determined in the airport vicinity restricted by equivalent sound levels A - 70, 65 and 60 dB(A) for daytime and 60, 55 and 50 dB(A) for night operation. In addition to the Aviation Act, the ÖNORM 95021 standard also specifies the use of these zones. At present a discussion is being held about a proposal of a new ‘Act for Protection against Aircraft Noise’.

In the **USA**, legislation determines limiting values for L_{AeqDN} as follows:

1. L_{AeqDN} lower than 65 dB(A) – normally acceptable, permitted development without restriction.
2. L_{AeqDN} higher than 65 dB(A) but lower than 75 dB(A) – normally unacceptable for all but specially designed houses.
3. L_{AeqDN} higher than 75 dB(A) – absolutely unacceptable zone, with prohibition to build any new structures other than for airport related purposes.

Similar noise criteria are defined in the UK but using L_{Aeq} . Permission for new dwellings will normally be granted below 57 dB, noise should be taken into account between 57 and 66 dB, permission would not normally be given between 66 and 72 dB, and it would normally be refused in zones with noise above 72 dB. Similar guidelines apply to night noise, but the limits are 8 or 9 dB lower. In its White Paper on Airport Policy in December 2003, the UK government stated that it wishes to see airports offer to assist households to relocate if they are subject to 69 dB or more due to a development, and to offer acoustic insulation to houses, schools, hospitals, etc if they are subject to 63 dB or more.

In Slovakia legislation determines limits for four different categories of land use for day (06h00 – 18h00), evening (18h00 – 22h00) and night (22h00 – 06h00) air transport operations (Table 20-1).

If an airport operates continuous noise monitoring system the equivalent A noise level can be

increased by 5 dB but the weekly average level can not be exceeded. Also $L_{A,S,max}$ limit could be exceeded during a day or evening three times and twice during night.

Table 20 – 1 Land use category noise limits

Land use category	Noise limits [db]					
	Day		Evening		Night	
	L_{Aeq}	$L_{A,S,max}$	L_{Aeq}	$L_{A,S,max}$	L_{Aeq}	$L_{A,S,max}$
Zones with special noise protection, hospitals, spa, etc.	50	70	50	70	40	60
Urban areas, schools etc.	55	75	55	75	45	65
Areas in the vicinity of airports and air routes	60	85	60	85	50	75
Industrial areas	70	95	70	95	70	95

In the Czech Republic the legislation for air transport noise specifies limits for the equivalent A noise level for a daytime (06h00 – 22h00) and night (22h00 – 06h00). The highest equivalent noise level is determined by summation of the basic noise level $L_{Aeq,T} = 65$ dB and corrections according to the land use category. The correction for the urban areas is 0 dB and for industrial zones without residential blocks +5 dB. For night operations there is always a correction -10 dB.

The land use and compatibility planning is, in the long run, the most effective way to control noise around the airports. The Airports Council International (ACI) adopted a resolution in January 2000 which urges the co-ordination and unification of EU policy in this field.

20.2.5 Aircraft Noise Measurement

The measurement of air transport noise should reflect the choice of indicator used to evaluate the noise load caused by air transport. This will determine the type of instrument and the time for which the measurements are taken. The method and equipment used for long period monitoring will be different from those for short-term tasks such as week-long surveys. However, the results from both sets of measurements should be compatible.

In choosing the method of measurement, it is important to take into account the purpose for which the evaluation will be performed: control of the legislated noise limits, control of adherence to the chosen flight procedures, verification of the predicted data. The choice of the location of the noise meters also depends upon the purpose of measurement. For verification of prediction and control

of the protective noise zones, it is necessary to choose measuring points with the lowest acoustic background possible, away from populated areas. When the purpose is to control adherence to health or annoyance limits, the measuring points are located in the inhabited zone and in the areas where noise sensitive activities are situated. In such cases it is often very difficult to identify noise that is caused solely by air transport and special measuring apparatuses and special rating techniques are required.

20.2.5.1 Short Term Measurement

Short term measurements should serve to control adherence to the set limits for a given category of activity, to control and verify the predicted noise load in the vicinity of airports and flight corridors, and to make special measurements such as comparing noise from an aircraft with its certified values. In a short-term measurement it is necessary to observe whether individual sound events are caused by air transport, or whether they are caused by other sound sources. The measurements should therefore always be performed with staff in attendance who identify the type of sound event as it is being measured, unless it is possible to correlate the timing of aircraft movements very accurately from radar traces. A measuring system may also be used that only provides a record of each noise event that exceeds the background noise level. The record should be qualitatively and quantitatively in such a form that will allow the noise event to be positively linked to the cause.

The level of sound at which the recording should start may be selected. This will depend on the background level, the time for which it is exceeded, and other characteristics of the noise trace.

Short-term measurements should be performed with sound level meters of class 1 accuracy, in compliance with IEC 61672 standards. Measuring apparatus should be able to measure simultaneously maximum A-weighted sound level and equivalent A-weighted sound level in a certain time interval. Simultaneous measurement of A-weighted sound exposure or time level should also be possible.

If a sound level meter that can measure these quantities simultaneously is not available, the sound signal may be recorded, in such a way that the time, frequency and dynamics are unchanged, in a suitable recording medium, for example by means of an analogue or digital tape recorder. Alternatively, the trace can be transformed into a digital form and saved in computer memory. Then the chosen indicators may be evaluated later with a suitable sound measuring apparatus. The recording equipment for saving the original signal should fully comply with the requirements specified by the IEC 561 standard.

If descriptors derived from perceived noise level, e.g. in aircraft certification, are used for noise

evaluation, it is essential to use a multi-spectral real time analyzer with spectrum sampling of 500 ms as a minimum if detailed measurement is required. If it is only a preliminary study, A or D-weighted sound level measurements may be used for determining approximate perceived noise level $L_{PN(\text{approx})}$ and approximate effective perceived noise level $L_{EPN(\text{approx})}$ respectively.

Microphones for free field should be used in compliance with IEC 61672, with a cover against wind or rain. Microphones with these supplementary features should comply with the characteristics determined in IEC 561 and ISO 3891. The microphone should be located at least 1.5 m above the terrain level, or at least in a minimum of 1.2 m from the outside wall of a building if the measurement is performed in the building façade.

Before and after each series of measurements, an acoustic calibration must be performed with a microphone calibrator. When the measurement is performed during several days, the calibration must be carried out at least once a day. In the course of the measurement, temperature, air humidity and wind speed must be monitored. After measurement, the results are processed in a suitable manner into the prescribed form. They may also be used in verification of predictive methods and development of mathematical models for aircraft noise simulation.

20.2.5.2 Long-term noise monitoring

Long-run noise monitoring is performed for the purpose of a long-run control of adherence to the defined limits of noise load for a certain location, for land use and compatibility planning and for monitoring actual air traffic activity which from time to time exceeds the noise limits. In such measurement it is also necessary to monitor aircraft movement through the same airspace where the noise is being generated. Aircraft movement monitoring may be provided automatically by processing radar information. The data on the aircraft movements are matched with the noise events detected by the noise monitoring. The noise load originating only from air transport may then be separated from other noise sources.

Unification of the results from aircraft noise monitoring and track keeping (NTK) radar data on aircraft movement may be performed in real time or additionally by appropriate data processing by computer software.



***Figure 20-4 Terminal for a permanent aircraft noise monitoring Environmental Sound Analyzer NOR 121 with a multi-spectral analyze and audio recording from a sound events of fly-over, NORSONIC AS Norway, with control unit and post-processing software TOPSONIC Ltd. Germany
(Photo: Courtesy NORSONIC AS)***

In accordance with the above mentioned, long-run monitoring of aircraft noise may be performed by means of two types of equipment:

1. Measurement is provided by means of instruments that simultaneously measure the required rating quantity (e.g. maximum and equivalent A sound levels) in the specified time interval.

- Measurement is provided by means of instruments that simultaneously measure and record the continuous course of evaluation descriptors averaged and evaluated from a short-term interval.

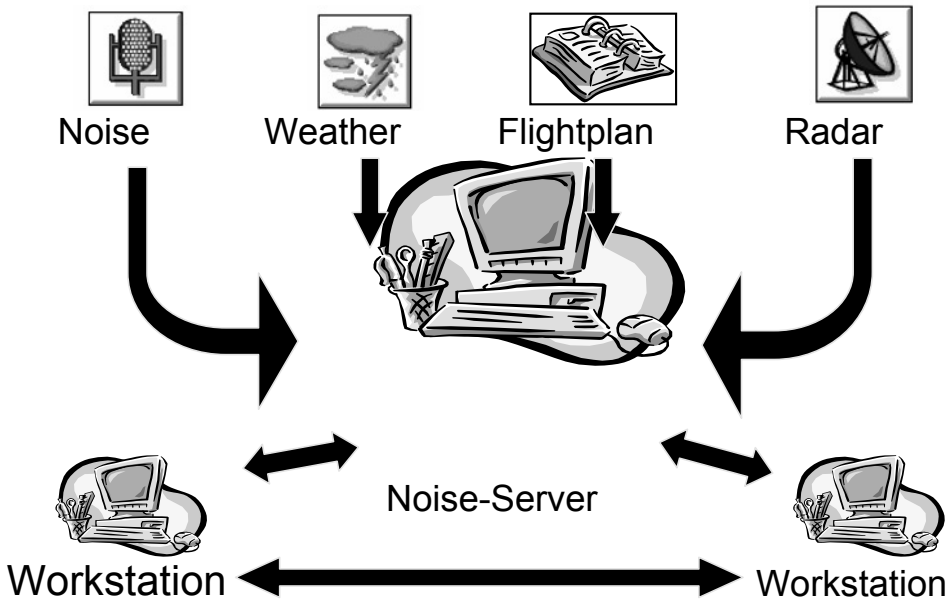

Figure 20-5 Aircraft Noise Monitoring Network – basic scheme
 (Source: TOPSONIC, Ltd. Germany)

Both of the systems may transmit the data from the noise monitoring units to the central control location for processing in two ways:

- Data transmission is provided in real time, i.e. each instrument is constantly directly connected with the central measuring point and the data are continually transmitted to that point. Connection may be provided by a local network or by means of telecommunication lines. Output may be shown also on monitors in selected neighbourhood centres or airport terminals. The UK’s East Midlands Airport (EMA) is the first in Europe to allow the public to access the system output on the internet with a 24 hour delay, using a package called WebTrak. The viewer can see the track being flown, the flight number and the altitude of all operations, allowing them to identify aircraft they believe to have been off track or too low (<http://www.eastmidlandsairport.com/cms/173/webtrak.html>). EMA, with 5 mppa, finds it necessary to employ 4 people to manage the environmental control system. This includes a complaint procedure; half of the complaints are generated by one person.

2. Data transmission is performed in discrete batches after certain time intervals. Data from noise measurement are saved in the local memory of the noise measuring equipment and, at the specified time, as a rule once in 24 hours, they are transmitted to the central processing point. Again, a local network or the public telecommunication network may be used for that purpose.

In the majority of cases, a combined system is used in big airports. Some measuring places are continuously connected with the central control point (Figure 20-4), while the data transmission from others is intermittent. The majority of systems for aircraft noise monitoring are augmented with one or more mobile measuring stands, which are most often located in a dedicated vehicle.

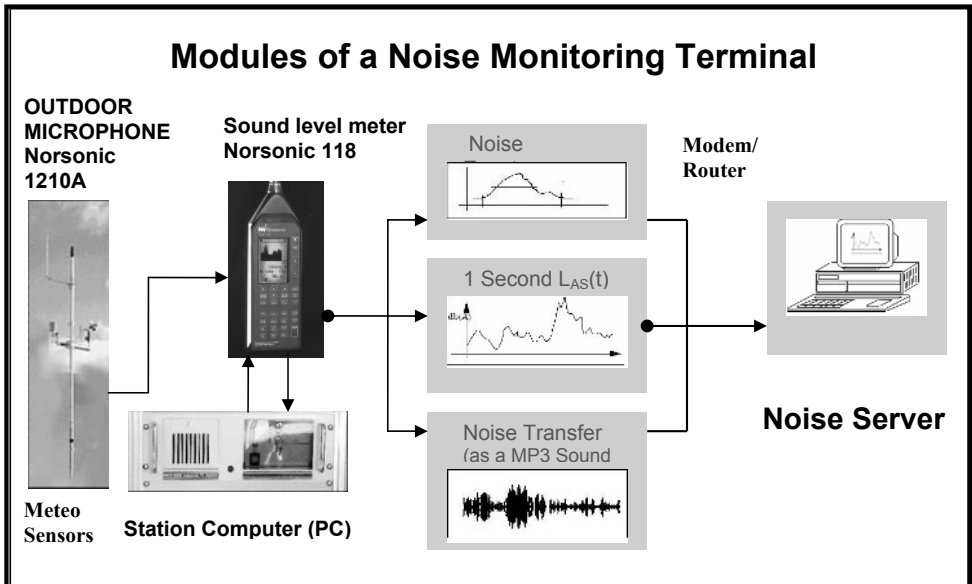

Figure 20-6 Aircraft Noise Monitoring Terminal – Principle form
 (Source: TOPSONIC, Ltd. Germany)

Simultaneously with the sound signal measurement, it is necessary to measure also barometric pressure, air temperature and humidity, wind direction and speed. The airport operator usually performs these meteorological measurements as well as the noise monitoring (Figures 20-5, 20-6).

20.2.6 Prediction of Air Transport Noise

Mathematical models are used as the basis for computer programmes that predict the noise load in the vicinity of airports. The load may be predicted in the form of noise contours of equal levels of the chosen descriptors, and also of maximum noise levels at specific locations. Just as there is no consistent methodology for selection of the descriptors and the method of evaluating noise around

airports, so there is not consistent international recommendation or directive for the prediction of aircraft noise load in the vicinity of airports.

In Germany the method of evaluating noise by prediction is determined by the Act on Protection against Aircraft Noise. Long-run equivalent A-weighted sound level is the descriptor used. The method is based on the categorisation of aircraft into noise classes. Acoustic pressure levels in octave bands, which are determined on the basis of measurement for the given aircraft categories, are used as inputs. They are integrated through the six months during which the airport transport is the highest. Protective airport noise zones are determined by means of the computation, as described above. The computation and projection of the contours are realized by means of a polynomial formula. Noise load evaluations by prediction in the vicinity of all the larger airports, military ones included, are performed under the legislation. Each airport then has a legally valid map marked with both of the protective zones. The polynomial itself is also reported. A control of adherence to the determined noise levels in the protective zones is also defined. If an increase of more than 4 dB(A) is detected by means of long-run measurement in the outer edge of one of the zones, a new noise load evaluation by prediction should be performed in the airport.

In the USA several methods for computing were elaborated in the past. The main descriptors used are L_{AeqDN} , NEF and CNEL. The US Government has financed through the Federal Aviation Administration the Integrated Noise Model (INM), which allows the noise load to be determined consistently in the vicinity of any airport. The programme allows the majority of the noise load descriptors to be calculated. A similar programme called NOISE MAP was developed also by the USAF for their own requirements.

In all these models, the path of an aircraft is approximated by means of a series of straight flight segments. In each segment, time-integral computation of target descriptors, which are computed from sound exposure level or perceived noise level of individual sound event, occurs. The maximum A-weighted sound level contours and maximum perceived tone-corrected noise level (L_{PNTM}), are computed directly from these descriptors.

The computation at individual points of the grid map is performed separately for each independent aeroplane that is considered in the model. Noise characteristics of individual types of aircraft acquired from aircraft certification or from special measurement may be used as input data for computation. The data collected during certification are incorporated into the INM. However, these data are not part of the public dissemination of certification data, the latter only covering the noise results for the three measuring points specified in Annex 16. In the event that data on maximum A-weighted sound levels or maximum perceived tone-corrected noise level are not available for some types; these will be computed by means of an empirical formula based on linear regression. In the computation, the effects of flight characteristics, procedures and aircraft

configurations during take-off and approach are taken into consideration.

In Switzerland the program FLULA is used for calculation of noise exposure in the vicinity of an airport. In this case a simple mathematical model is employed. The aircraft trajectory is replaced by a series of points in space which match one second intervals of aircraft movement. A discrete noise source with directional characteristics is placed at each point. These sources substitute moving aircraft noise emissions (Figure 20-7). Taking into account noise attenuation in the ground layer of the air at every point, the intensity of noise and its maximum value during the aircraft movement is calculated. The calculation is done separately for each type of aircraft on a selected trajectory and respective flight procedure.

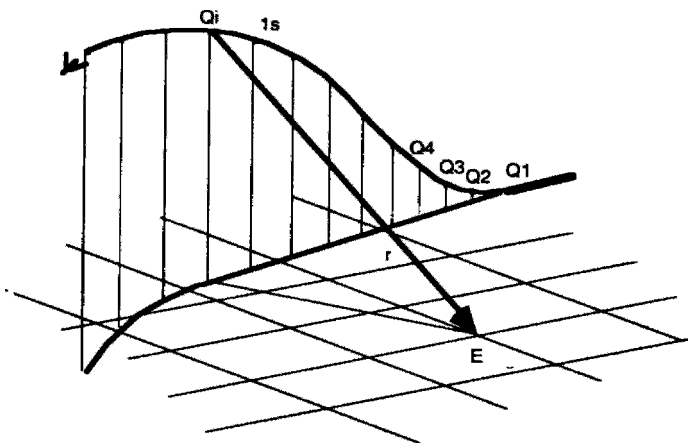

Figure 20-7 *Simulation of the aircraft movement and calculation of the noise intensity on the ground, (Source: EMPA, Switzerland)*

The resulting intensity is multiplied by the number of movements of the particular aircraft type and in every point the maximum noise value is calculated. For every point projection on the ground surface, the noise exposure level is determined from the noise intensity or by the time distribution equivalent noise level A is calculated. Also maximum noise levels NNI(A) contours or any other descriptors are derived.

The whole mathematical model is based on the directional noise characteristics of a particular aircraft type defined by multi-spectral noise measurements in a third-octave analysis of the noise. The analysis is worked out for different flight situations and the aircraft trajectory is continuously monitored by precision radar system and recorded. Based on these data, special directional noise characteristics for each aircraft are created and thereafter used in the noise modelling.

There is a continuous effort to unify air transport noise prediction methods. However, noise expert groups meetings (NATO CCMS-GROUP, Aircraft Noise in a Modern Society, Symposium on Aircraft Noise Abatement Receiver Technology) did not achieve that aim. Every country has different legislation based on its historical background and different noise descriptors for the air transport noise assessment. There is no common legislation even on the EU level. The report from the 21st meeting of ECAC in 1997 - Doc 29 - Report on Standard Method of Computing Noise Countours Around Civil Airpors described in detail a method of noise exposure from air transport in the vicinity of civil airports (Figure 20-8). This method uses two descriptors - maximum sound level A and sound exposition level A. The model is based on a noise database for different civil aircraft categories. The inputs for particular aircraft types are based on the mentioned descriptors for third-octaves with average band frequency between 50 Hz and 10 kHz for different aircraft speeds, power plant settings and minimum distance from the aircraft trajectory. The method is based on the descriptors calculations for the aircraft movement points defined by the aircraft performance characteristics. The method is based on the calculation of individual descriptors for every point of the grid for each of the aircraft movements. Each of these aircraft movements is defined by the aircraft performance characteristics. The final noise level calculation is done by simulation of individual flight segments. The noise contours are interpolated between calculated points. However, this document was not adopted by the European states as a standard. It is only a recommendation of The European Parliament and the Council - Directive 2002/49/EC from 25 July 2002 relating to the assessment and management of environmental noise. The document describes methods for noise prediction in the vicinity of civil airports and creation of noise strategic maps.

Within the projects IMAGINE and HARMONOISE financed by the European Union a new method of air transport noise calculation is being prepared. The mathematical model will be based on the aircraft trajectory segmentation principle and should take into account the terrain morphology, attenuation in the ground layer and meteorological effects. The input data will be similar to the ECAC model. Aircraft types will be grouped according to power plant types, similar to INM. As there is no database available with the third-octave noise spectrums for different engine loads and flight procedures, the projects include a series of noise measurements for calibration of noise data from the INM. The output data should have a similar structure as the Swiss FLULA model.

Recently there has been a considerable effort to unify the predictive methods used for determining aircraft noise at airports. Unfortunately no useful conclusion was reached. ICAO recommends the method for computing noise given in ANNEX 16. The use of this method allows comparison and evaluation of airports on an international basis.

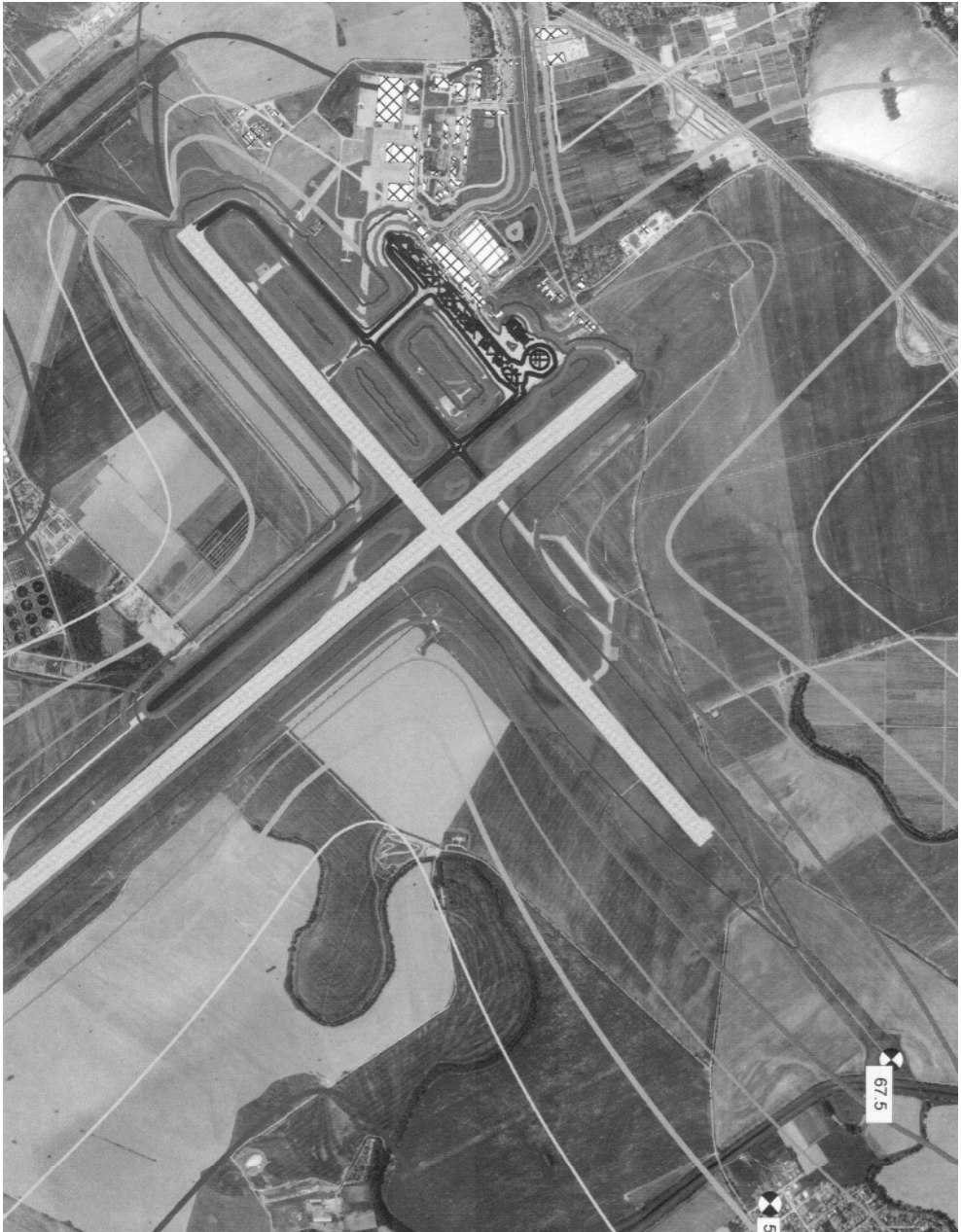

Figure 20-8 *Noise contours of equivalent A-weighted sound level for day - prediction of noise rating around M.R.Štefánik - Bratislava airport for the New Terminal Project*
(Prediction M. Kamenický, with CadnaA Software, ECAC. CEAC Doc 29 and ISO 9613)

20.2.7 Airport Noise Mitigation and Noise Abatement Procedures

Airports need to adopt noise mitigation measures in order to pacify their local communities or simply to behave in an environmentally responsible way. The airport operators use measures in addition to noise abatement approach and departure procedures as noise insulation of houses, different compensation schemes of residents or noise protection walls (Figure 20-9). They include displaced thresholds, preferential use of runways which demand more crosswind and tailwind movements than some airlines are happy with, restrictions on the use of reverse thrust, limits on daily movements, curfews and night quotas.

The takeoff noise should mainly be a problem for the heavy four-engined aircraft, since the performance of the twin-engined aircraft could allow them to be at a comfortable altitude before crossing the airport boundary.

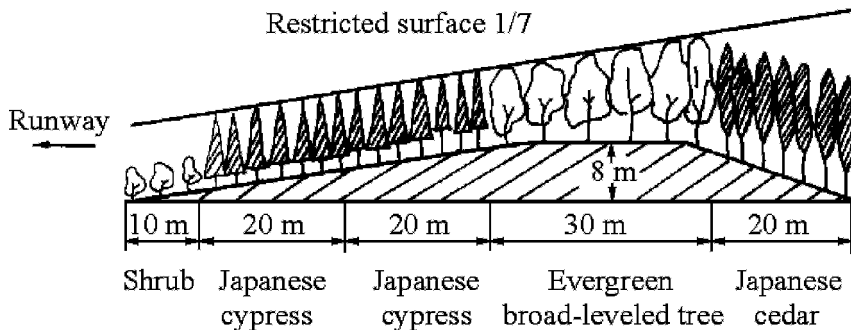

Figure 20-9 The noise protection wall

(Source: Airport Planning Manual, Part 2, Land Use and Environmental Control)

This is compromised by the use of reduced thrust and by intersection takeoffs. These are two examples of the way today's operating procedures differ from those used in certification. A further example is the height at which the thrust is cut back, which is more important for the noise-critical large four-engined aircraft. In certification, this is done to minimise noise at the certification point 6.5 km from start of role, whereas it is normally controlled by specific noise abatement procedures, instructions in the operating manuals or operators' preferences. If this class of operations is to operate satisfactorily, it is essential that the procedures are chosen to minimise noise at the most sensitive locations.

The increasing use of high bypass twin-engined aircraft has transferred attention from the takeoff

noise to the final phases of approach, where the dominant noise affecting L_{eq} contours comes from either the front fan or from the airframe. This phase is difficult to improve, because the aircraft needs to be stabilised on a standard three degree glideslope. There is, however, also increasing concern about noise further out under the approach path, many complaints coming from these areas in the early morning.

The noise under the early stages of approach could be mitigated by changes to the flight procedures. The two segment approach produces the expected large benefits between 20 and 10 NM, a slight disbenefit at 7 NM being due to the relatively early selection of landing flaps. Both the Continuous Descent (CDA) and the Decelerating Approaches offer a good proportion of the two segment approach benefits, the latter being the more preferable, the benefits all coming before 8 NM from touchdown. These types of approach require much cooperation between the pilots and air traffic controllers, but initiatives at Heathrow to increase CDA have been successful.

Closer to the airport, where noise levels would be expected to cause more annoyance, one of the main measures used by national regulators and airport companies in attempting to limit arrival noise is the stipulation of minimum altitudes for joining the Instrument Landing System (ILS). At Heathrow this altitude is 2 500 ft during the daytime and 3 000 ft between 2300 and 0700 hours. At Birmingham, Gatwick and Stansted the stipulated minimum is 2 000 ft.

If the approach can be flown at a higher angle all the way to the flare before touchdown, the noise benefit seen in the two segment approach can be extended through the areas of greatest noise. The potential benefits would come from the greater distance between the aircraft and the ground, and also the lower thrust levels required for greater descent angles in the landing configuration. Airbus has estimated that the A310's 80 dB(A) contour area decreases from 1.45 km² to 0.51 km² when the approach increases from 3 to 5 degrees. Approaches are regularly flown into Innsbruck Airport at 4 degrees and into London City Airport at 5.5 degrees with 100 seat jets, the latter airport having used 7.5 degrees while only operating with turboprop aircraft. Although the glideslope has to be intercepted by 3 000 ft and careful attention has to be given to speed control, the approaches with BAe 146 aircraft are flown at the aircraft's normal approach speed, they can be performed with the dive brakes inoperative and the only modification to the aircraft is a button to turn off the rate of descent element of the Ground Proximity Warning System (GPWS). Despite the need for extra care, there is no evidence of a greater missed approach rate than with normal operations on the same aircraft.

Up to 4 degrees, a conventional jet aircraft can be used at the normal approach speeds but lower thrust settings. Conventional aircraft could be used at still higher angles, particularly if the landing weight could be decreased, but this is unlikely on a regular basis. For angles greater than 4 degrees, it would therefore be necessary to redesign the aircraft to reduce landing speed for a given

weight. A problem with steeper approaches at the moment is therefore that not all aircraft could fly them, so it is necessary to segregate the traffic in some way. This may be by displaced thresholds or approaches to new short parallel runways, which would give fewer ATC problems.

20.3 CONTROL OF GASEOUS EMISSIONS

Air transport consumes only 5% of the world consumption of oil products. Every year there is an improvement in the efficiency of energy utilisation of 3 to 4%. The turbo-jet engines built after 1982 produce 85% less unburned hydrocarbons (HC) than the engines built in the seventies. Carbon Monoxide (CO) exhaust gases decreased by 70% in the same period. Jet aircraft account for approximately 2 to 3% of the world-wide production of Nitrous Oxides (NO_x) and Carbon dioxide (CO₂). Surface transport, by contrast, produces 22% of carbon emission and Europe's merchant ships use around a third more carbon than aircraft do [227]. Air transport contributes approximately 1% to global warming as a consequence of CO₂ emissions.

The procedures of emission certification of aircraft engines, limits of harmful substances and specifications of metering devices are included in Annex 16, Part II. Aircraft are certificated for engine emissions as calculated over the ICAO Takeoff and Landing (LTO) Cycle. This assumes operational characteristics for approach from 1500 feet, taxi in, taxi out and takeoff and climb to 1500 feet that are not necessarily the same as today's operations. In particular, there are differences in taxi time, in engine setting for taxi and takeoff, and no account is taken of the start-up cycle. However, it is not the objective of this book to deal with the reduction of harmful substances at their source. There are operational measures that decrease the volumes of products of combustion at airports, including optimising the movement of aircraft on the apron and taxiways, operational towing of aircraft to the holding positions for take-off and taxiing after landing with the minimum necessary number of engines running.

Reduction of emissions in airport operation can often be achieved by the same procedures which are used for decreasing noise pollution and fuel consumption. During the take-off and climb it is possible to achieve a reduction of emissions by selecting the optimum aircraft configuration and engine setting. Flight paths can be shortened during approach and landing. Descent with higher approach speed and with lower flaps settings reduces aerodynamic drag, so requiring less thrust and decreasing noise. It may also result in a reduction of exhaust products, depending on the product and how it varies with engine power. The amount of CO and HC produced per kilogram of fuel burnt reduce with increase of power, while NO_x increases.

Aircraft generally contribute much less to air pollution in the vicinity of an airport than the power generation at the airport and particularly surface vehicles on the airside and access transport. It is

necessary to pay the utmost attention to the design of the system of surface transport to reduce the pollution as much as possible, as discussed in Chapter 14. The FAA's Emissions and Dispersion Modelling System (EDMS) can be used to assess and model the quantity of gaseous emissions produced in the vicinity of airports. Future levels can also be estimated if the characteristics of combustion and energy use can be predicted.

It can be assumed that the worst contamination of ambient air on the apron occurs in the operational peaks in the summer period. In the future it will be necessary to introduce a higher proportion of electrically powered ramp handling equipment. At the same time it will be necessary to decrease the use of aircraft auxiliary power units (APU) by using the central supply of electrical power, air conditioning and other media directly to the aircraft by lines located on passenger loading bridges or built into the apron.

The experience of most developed countries shows that the quality of ambient air in most cases is lower on airports than in the cities, the exception being by the drop-off and pick-up kerbs in front of the terminal, and sometimes in apron cul-de-sacs.

On the other hand the air transport industry's energy consumption has been growing faster than that of other polluting industries. Air transport will soon be central, not marginal, in the emissions issue. In principle there are two possible solutions to how to limit emissions: to tax them or to let polluters trade the right to emit.

Under the Kyoto climate change treaty, the EU committed itself to reducing carbon emissions by 8 per cent of 1990s level by 2012, a commitment that is currently off track. However, international aviation is neither subject to Kyoto or other commitments nor to fuel tax or VAT. In line with the EU long term strategy, Europe should take a leadership position in global aviation in order to reduce the climate change impact of aviation.

In December 2006 the European Commission prepared a proposal that all airlines using European airports will be required to take part in the carbon-reducing scheme. The plan is that all flights arriving at or departing from an airport in the Community as of 1 January 2012 will participate in an emissions trading scheme [196]. Foreign airlines may get a two year waiver and they will not have to be a part of the scheme until 2013. On the other hand intra-European flights will be handicapped as, under the proposed scheme, they must enter the trading scheme from the beginning of 2011. At the beginning the scheme will cover carbon dioxide emissions only and a new proposal covering nitrogen oxide pollution will be prepared by the end of 2008. The principle is the same as in other industrial sectors. Air transport will be given specified amount of CO₂ pollution credits. If the limits will be exceeded the 'polluter' will have to buy credits from other companies - resulting in a carbon market.

20.4 PROTECTION OF WATER SOURCES

Construction of the airport and in particular construction of the runway can disturb the ground water system not only in the area of the airport but also in the wider surroundings of the airport. Rain water drains quickly from the paved areas, which can cause flooding in the water courses that are fed by the rain drains. Flood waters are therefore usually fed into retention tanks.

In the new Terminal 2 of Frankfurt Airport the rainwater is being used for services. Rain water is used for cooling of air conditioning, in fountains and in 800 lavatories, which consume approximately 8000 m³ of rainwater a year. Before use the water is chemically treated and cleaned in sand filters.

Most countries have standards that set the water quality. However, the limits set by airports are usually more stringent. For example in 1995 Manchester Airport imposed the following maximum concentrations limits: 10 mg/l BOD₁, 50 mg/l SS₂, 2mg/l ammoniacal nitrogen, no visible oils.

Before entering the sewer the waste waters must be properly treated. This treatment of the waste run-off from the operations of washing of vehicles and aircraft, from the accumulator room, the boiler house, the degreasing workshop, the kitchen and dining hall must meet other health and safety requirements regarding the contents of heavy metals, chlorinated hydrocarbons and sedimentation substances.

Sewage water from the airport is cleaned in normal water treatment plants. Drainage from the movement areas of the airport require a special treatment due to the oil products or de-icing substances used in the winter. Rain water from the paved areas, in particular from the apron, can be cleaned in a special treatment plant on the airport, with separation of oil products, or the collector can be connected to the local municipal treatment plant. Special procedures have to be prepared and put into operation in the case of a large oil spillage. In addition to the measures to cope with an oil spillage, the contingency plan should contain the following:

- procedure for removing spilt fuel
- procedure for closing or sealing the sewage system
- procedure for reporting the accident
- prohibition of routine and planned maintenance on the areas not equipped with a trap for oil products

1 BOD - Biochemical Oxygen Demand

2 SS - Settleable solids (mg/litre) - suspended solid after one hour quiescent settlement

→ minimising the washing of aircraft on the apron.

Particularly dangerous areas, e.g. fuel stores, hangars and maintenance workshops, have to be equipped with traps for oil products and inspected regularly.

At the same time it is necessary to pay attention to possible water or soil contamination during fire fighting training. These training activities should be permitted only within a specially dedicated area.

20.5 LANDSCAPING

Air transport needs less than 8% of the land needed by rail transport and less than 1% of that needed by road transport. In relation to the number of transported passengers, the land is used 5 times more efficiently by air transport than by railways and 6 times more efficiently than by roads.

None-the-less, airports can cause considerable visual intrusion. They are best placed on elevated ground in the interests of clear flight paths, so are likely to alter the skyline with levelled ground and tall buildings, particularly the control tower. At night the approach lights and the apron floodlights are a distraction, the more so because airports are normally sited in open countryside.

When planning the development of an airport, one has to consider not only the airport site but also its surroundings. The planning must be integrated into the urban planning of the region. In addition to other impacts, the impact of the airport on the appearance of the landscape must be assessed. It is particularly difficult to situate or hide large airport facilities like hangars and terminals so that they do not disturb the appearance of the landscape. The new terminal at Bristol in the UK was limited to one floor on the airside face to minimise its impact on the skyline. Changing the landscape in the vicinity of the airport, such as tree planting, can be used to minimise the negative impacts of the visual intrusion. Landscaping by the creation of planted buffer zones can also help to control air pollution and minimise the propagation of noise. However, the types and composition of the trees must comply with recommendations for discouraging birds. In this connection, it is necessary to pay attention to the treatment of waste from the airport. Earthworks (bunds) can be built as acoustic barriers but can reduce the view and create their own visual intrusion.

Landscaping is also important in managing the habitats and hence the species of flora and fauna around the airport. Careful planning can avoid habitats being isolated by leaving movement corridors, provide habitats for endangered and protected species, and discourage heavier birds. Where necessary, replacement sites need to be created for habitats, including wetlands, and historic buildings moved. Some projects have had to be abandoned when this has not been possible, or

when too much built heritage would have had to be destroyed.

Together with improvement of the environment on the airport, airports are increasingly utilising their land as recreation zones not only for the visitors to the airport but also for its employees and inhabitants of adjacent cities. Sports grounds, golf courses, areas for water sports etc. have been located at or near airports. These activities, together with other airport services, are a significant source of airport revenues, but it is necessary to avoid large congregations of people under the flight paths in Public Safety Zones.

20.6 WASTE MANAGEMENT

An airport with a capacity of approximately 5 million passengers a year can generate as much waste as a small town. Airports generate between 0.5 and 1.0 tonnes per annum per 1000 passengers. To minimise the negative impact on the environment in connection with waste dumping, it is necessary to look for ways to decrease the quantity of waste particularly by recycling, composting, reuse and introduction of wasteless technologies. In developed countries the concepts of separation and recycling are supported by legislative measures. These measures include tax relief and direct state subsidies. This will further be accelerated by the fact that in all countries there will be a gradual increase of prices for the dumping of waste.

Airport waste contains a high proportion of substances and raw materials which really need to be sorted out and recycled. The sorting of waste must be considered not only as a measure for protecting the environment but also as a financial asset.

One of the main problems in some of the third world countries is a low social conscience. Economic growth is felt to be more important than the problems of waste management in these countries. It is therefore important to pay increased attention to the education of the airport employees in waste management, in particular in the key workplaces which are the main generators of waste.

The foundation of good waste management is ascertaining the composition of the waste. The information can be obtained from the waste disposal company, complemented by an analysis of the waste into individual fractions.

Depending on the airport size and the location and type of the individual workplaces, the sorting of waste can be organised as centralised or decentralised or as a combination of both procedures. The centralised collection and sorting of waste requires high investment and personnel costs, but is more tidy and provides better separation of individual fractions and therefore also better opportunities for negotiations with consumers of classified waste. Decentralised collection can

allow certain kinds of waste, such as paper and carton, to be separated at each location. Biodegradable organic materials, which can be composted, should be separated on the airport and this can decrease the total quantity of waste. A difficulty is that organic waste from aircraft must be considered as infectious material. Therefore in some airports it is sterilised before further processing.

The airport company can offer the waste management system to other firms in the airport, because sorting out and recycling of waste are ineffective for small enterprises. For example, Amsterdam Schiphol's administration offers the possibility of separation and processing of waste to individual organisations at the airport. The total costs for such collection are about 25% lower compared with the classical collection process, where most of the waste is burnt. Waste can be solid or liquid, organic or inorganic, non-hazardous or hazardous. As many as 10 kinds of materials may be separated, but most organisations use three to four categories of separated materials. The main separation parameters are mass and toxicity. In the future, the containers will be equipped with electrical chips, which will not only generate automate invoicing but in the case of contamination of separated material by other waste, e.g. paper by metal, plastic etc., they will at the same time be able to trace the transgressor. However, the best waste management philosophy is not to let the waste be generated in the first place. It may be that the purchasing strategy should be reviewed to avoid unnecessary packaging or to emphasise materials with a low toxicity.

20.7 BIRD CONTROL

20.7.1 Introduction

The number of aircraft increases continuously. At the same time their speed increases and a great number of flights are performed in low altitudes by general aviation, military aviation and by commercial aircraft on landing and takeoff. Most birds also fly at less than 300 m above the ground. It is therefore inevitable that bird strikes are a continuing serious hazard for aircraft. At the very beginning of aviation, the low speed of flight made it possible for the birds to avoid a collision and the force of any impact was small. In most cases a collision resulted in minor damage to wind shields and leading edges of wings or the fuselage. The probability of collision was also small because of the small number of aircraft. Despite this, the test pilot Carl Rogers died after a collision between his aircraft and a bird in California in June 1912. His Wright Flyer hit a seagull, which jammed the steering mechanism and the aircraft and pilot fell into the sea.

Most of the birds quickly became used to the noise and speed of propeller aircraft and learnt to stay away from the dangerous airspace in the vicinity of the airport. The situation changed in the fifties after turbo-prop aircraft and jet aircraft were introduced. This increased the speed of flight, the aircraft's acceleration and their dimensions. Therefore it was more difficult for the birds to avoid

the flying aircraft and the impact force of a collision was greatly increased. The rate of collisions was also increased by the large quantity of air sucked into the jet engine and large dimensions of the engine intake. The jet engine also proved to be less resistant than piston engines to collision with the birds. Moreover, modern aircraft are quieter and therefore it is easier for them to escape the attention of the birds.

The cost to an airline as a consequence of damage to an aircraft after a bird strike can reach millions of dollars. It is not only the price for the repairs of the aircraft but also the costs in connection with taking the aircraft out of service, redirecting passengers and freight to other flights and the costs for accommodation and board of the passengers. Delay of the aircraft or its temporary withdrawal from service has a domino effect on the timetable of airline and all connecting flights. It can cause a substantial increase in operational costs and blemishes the good reputation of the airline. On the other hand, the cost to airports in preventing collision of birds with aircraft is also not negligible. On New York's J.F. Kennedy airport they exceed half million dollars a year, which is approximately the price of repairing two engines on a B 747 aircraft.

The size of the bird strike problem is different at each airport. In order to prevent bird strikes effectively in the vicinity of airports it is necessary to have an in-depth understanding of the customs and behaviour of the birds. It is therefore important for the airport administration to cooperate with ornithologists.

20.7.2 Bird Strike Statistics

ICAO began to monitor bird strikes in 1965, through the collection of bird strikes forms. In November 1979 ICAO requested all member states to report all collisions of aircraft with birds. An international system of collection and evaluation of data on collisions of aircraft with birds was set up, called the ICAO Bird Strike Information System (IBIS). A bird strike reporting form was sent to the member states. In order to maintain the continuity of data, this form is still used. Later a supplementary questionnaire was prepared for airlines, in which the costs in connection with the bird strike and detailed information on the damage to the engines should be entered.

To assist ICAO Member States in forwarding bird strike data to the ICAO Bird Strike Information System (IBIS) ICAO issued a Manual on the ICAO Bird Strike Information System - Doc 9332. It describes IBIS, giving details on the data entry, data retrieval and the bird strike database layout. At the present time analysis of more than 100 000 bird strikes hitherto reported indicates that:

- the number of incidents with significant damage to aircraft represents approximately 5% of the total number of bird strikes

- 69% of bird strikes take place in daylight, 15% take place at night and the rest of bird strikes take place at sunrise and sunset
- 65% of damaged aircraft with a weight above 27 000 kg have engine intake damage
- 29% bird strikes take place during the approach and 25% during the take-off run
- 51% of bird strikes take place below 30 m above the terrain
- in 91% of cases the pilots were not warned of the appearance of the birds.

Collection of data on bird strikes by ICAO is only one part of the total collection and evaluation of data necessary for the functioning of an efficient airport system of bird management. In fact the data from the IBIS system are only of small significance for any specific airport. It is necessary to complement these data by observations of the appearance of birds, maintenance reports, observations of pilots and air controllers and ornithologists on the airport or in its vicinity. For example, the pilot's report on the 'close approximation' of the aircraft with birds in the vicinity of the airport is just as important as the bird strike report, showing, as it does, that birds are a threat. The airport report should not be focussed only on whether there is a bird strike but also whether and where the birds appear in the vicinity of the airport. Only after all data had been processed and assessed it is possible to identify the scope of the problem and to propose and introduce an effective programme, the objectives of which are the decrease of the number of birds in the vicinity of the airport and the avoidance of bird strikes. The reporting procedure has to be co-ordinated by the responsible person and all airport employees must be acquainted with it.

The aircraft can be damaged by any kind or size of bird. The extent of the damage by the bird depends on the weight of the bird, speed of bird strike and on the strength of the aircraft structure. During the impact, the speed is changed within a very short period. The change of momentum of the body is proportional to the change of the speed and the change of momentum of the body equals the impulse force.

In mild climates there are indigenous, transient and migratory birds.

- Indigenous birds live all year in the same small area.
- The transient birds appear in a certain area only at nesting time. Then they move to other localities or roam over a vast area.
- During the year the migratory birds fly long distances. They have a specific direction and target, to which they fly by permanent 'flight routes'. Their nesting and hibernation places are very distant from each other.

The birds have their natural daily cycle, just as humans do. The beginning of the activity, as the

birds wake up, cannot be clearly determined. Some kinds of birds wake while it is still dark, others only after sunrise. The beginning of the activity is influenced by meteorological conditions. If the sky is overcast, the birds wake later.

The total number of birds changes in the course of the year. Most kinds are represented in central Europe during the spring and autumn migrations. In this period the birds are also most mobile. The spring passage is the shortest, while the autumn migration has been spread out over a longer period. The flight altitude is significantly affected by meteorological conditions. Smaller birds particularly do not want to lose visual contact with the ground. The average height of migratory flight is between 100 and 300 m.

The population of birds never spreads out evenly over a large area. The ecological conditions ensure that the birds are located in some 'islands'. As a rule, several species of birds appear in any specific environment, or habitat. The habitats can be:

- original and natural
- affected by human activities.

An airport's development normally means removing vegetation, trees and shrubs. This can cause the disturbance of the natural balance of habitats, and the eradication of existing plants and animals. Therefore it is necessary to consider the landscaping of the countryside so that it does not seriously disturb the ecological stability of the close vicinity of the airport, e.g. the ground water system. On the other hand the safety of air operations must not be endangered by an increase in birds, fog, dust, etc.

20.7.3 Change of the Habitat

The reduction of the number of birds in the vicinity of the airport can be achieved by changing the habitat so that it is unattractive for the birds. It is a system measure, which is often expensive but if the measures are considered during planning of the airport, the increase of costs is insignificant in comparison with the resulting benefits. System solutions connected with the change of habitat should represent perhaps 70% of the total bird control effort.

The preconditions for birds to inhabit the airport are in particular:

- feeding
- safe nesting
- safe resting
- en-route passage above the airport.

The possibility of feeding is probably the most important attraction. Waste dumps are very attractive for the birds. The construction of a new dump should not be situated closer than 13 km from the airport. The only effective method which can prevent birds feeding in the waste dump is to cover the dump by nets. It often happens that the visitors to the airport feed the birds. Earthworms are a delicacy for the birds, and there are many of them as well as other insects in the grass and on the paved surfaces after rain. Swarms of insects form over runways that have been heated by the sun, and they attract the birds to this worst possible location. Some species take advantage of a hard surface to break nuts open by dropping them. In the vicinity of the airport, birds of prey can catch mice, moles and other small rodents. Birds are also encouraged to find food on small ponds with an abundance of small fish, frogs, larvae and water plants. Significant foods for the birds are also various berries, seeds and agricultural plants.

Because of the great variety of various kinds of bird food, it is practically impossible to remove the sources from the airport. For example, during mowing of grass and hay collection, the birds collect the insects behind the machines. In addition to the elimination of natural and artificial sources of food it is possible to use chemicals to reduce the population of insects and rodents. Small water courses and swamps must be dried and backfilled, as in the vicinity of the Charles de Gaulle airport, or covered by nets, as at Bordeaux/Merignac or Marseilles/Marignane airports, in order to prevent the birds from accessing food. Attention has also to be paid to the system of tilling soil which has to be agreed by the airport administration with the owners of surrounding land. Hangars and other premises on the airport can create safe nests. The birds nest directly on and in the buildings, bushes and in other greenery, and sometimes also in the parked aircraft. On the aircraft themselves they nest most frequently in the gaps between the aerodynamic controls and the fixed surfaces, and in the engine nacelles. The nest can be built very quickly, within several hours. The nest can jam the controls, as can objects that are collected by the birds and stored there by magpies, jackdaws, crows, etc.

In addition to modifying the construction of hangars and buildings in order to prevent penetration of birds into the buildings, it is necessary to eliminate other suitable places for nesting on the airport. It is advantageous to keep a forest a safe distance from the runway, as it will be an attractive place for birds to live.

In connection with the development of Indianapolis International airport, a nesting place of swamp bats, which are listed as an endangered species, was destroyed. The administration of the airport decided to build a new suitable nesting place for the bats. They bought approximately 550 acres of forest and agricultural land along a nearby brook, which will be rebuilt as a swamp. 3000 nest boxes for the bats will be located in the forest. The total price of the forest is 3,3 million USD.

The wide and level area of an airport gives the birds a secure feeling. They cannot be attacked by

any enemy without being observed. Seagulls feel so secure that sometimes they bring their food to the airport specifically to eat it there. They make the runway surface dirty, and if they are scared the whole flock rises and makes a wall which cannot be avoided by an aircraft.

Special attention has to be paid to the maintenance of the runway grass strip and other areas covered by grass. It is best if the grass height is kept around 20 cm or more. Only a few species of birds like pheasants and partridges prefer long grass, whereas most birds rest on short grass or they search for food in it. If the grass is higher than 20 cm, the view of the birds is limited and they cannot move easily in the grass. In order to avoid frequent grass cutting and also to make it less attractive, there are special grass mixes, which grow up to the height of around 20 cm and in addition to this, they contain particularly sharp and thorny blades.

Birds get used to attempts to disturb them, and take refuge in the areas adjacent to the airport. Their reactions are unpredictable and are also a serious danger to air operations. Indigenous birds, i.e. those that live in the vicinity of the airport the whole year, are familiar with the air traffic operation and can avoid the dangerous places, except when young or below average intelligence. A bigger problem is represented by 'strangers' i.e. those birds which fly into the airport from another locality.

If the airport is located on a migratory route, it may be used by the birds as a resting place. A great number of birds can flock together in this way. The only effective counter measure is not to build the airport in this locality. Information on the movement of birds in the vicinity of the airport is published in the air information manual (AIP).

20.7.4 Bird Scaring

It is not likely that the changes in habitat will completely succeed in removing the birds from the vicinity of the airport. In fact, at any time a flock can fly onto the airport and sit on the runway. The sporadic appearance of birds at the airport must then be controlled by scaring them off, particularly when there are air transport operations. The flock of birds must be scared and dispersed as soon as possible, because a flock of birds on the ground attracts other birds of the same kind and the flock gets bigger. Also, it is easier to disperse a small flock than a big one. The easiest way is to scare the birds before they settle down on the airport.

Bird scaring methods vary in their effectiveness depending on the situation. Some techniques can be used only sparingly, because the birds get used to them. It is often advantageous to combine the techniques or to change the intensity of use. Continual scaring can, none-the-less, significantly reduce the number of birds in the airport.

The bird scaring schedule must be set in advance in order to avoid repetition. Only in this way is it possible to ensure that the birds do not get used to the scaring procedure. The birds react immediately to some methods and fly away, at other times they only fly away after some delay. Different species of birds react differently to various techniques.

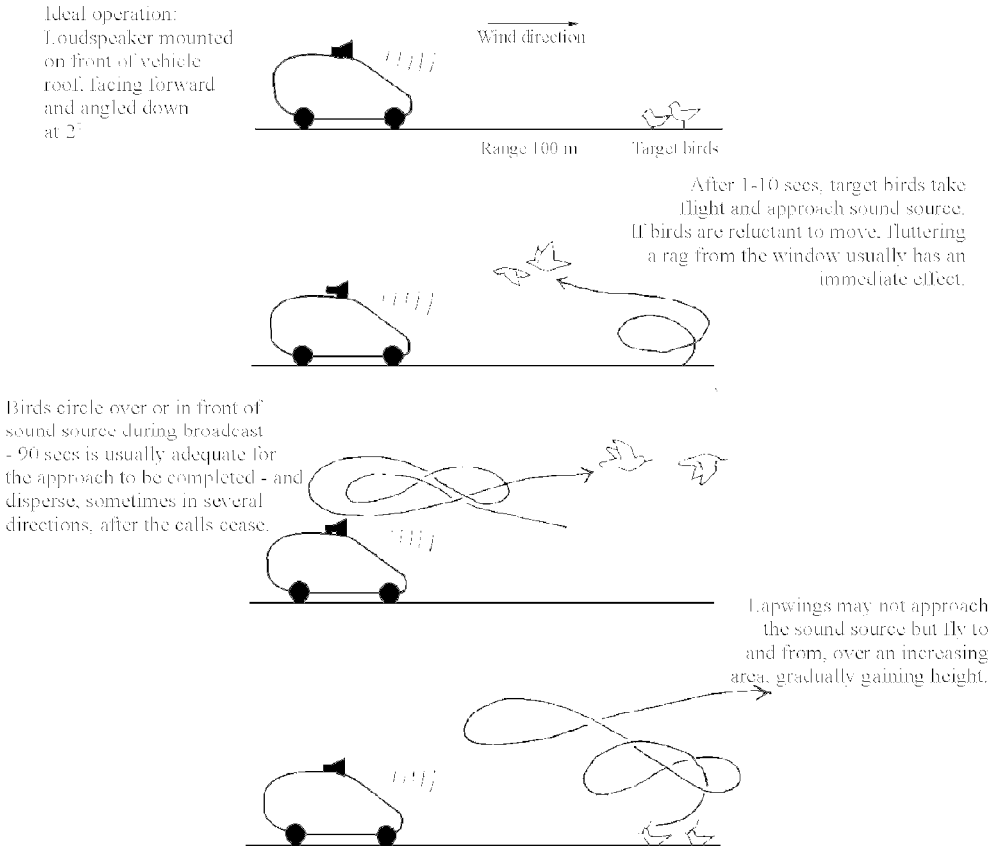

Figure 20-10 *The bio-acoustic method of bird scaring*

The success of each technique is apparent immediately after it has been used. Scaring techniques can be divided into:

- sound
- visual
- mechanical
- catching of birds

- falconry
- chemical.

Among the sound techniques are: bio-acoustic techniques, artificial sounds, pyrotechnical means and gas guns.

The bio-acoustic technique is a very successful method of bird scaring. It is based on reproduction of the records of distress calls, warning calls, sounds of birds of prey, or command sounds which are made by the flock of birds when taking off (Figure 20-10). The most authentic sounds are records obtained directly in the natural conditions of birds reacting to danger. The reaction to warning calls differs between species of birds. Starlings fly away immediately, seagulls and crows rise, they can circle once or twice and then they fly to the loudspeaker and back several times until they gradually disperse, or they disperse only after the call has finished.

The advantage of warning calls is that the reaction of birds is inborn and this technique can therefore be used for a longer time than other techniques. The disadvantage is that the birds react only to the call of their own or closely related species. The warning call of some kinds of birds, e.g. of doves, is not known. The recording and its reproduction must be high quality, because the birds are capable of recognising that this is not the real call. It takes time to scar birds. Therefore it must not be used immediately before the take-off or landing of the aircraft, because the birds could just fly into its path. Fixed or mobile facilities can be used for scaring. The advantage of mobile facilities is that they are cheaper and more effective than fixed systems, and the birds do not get used to them so easily. It is advantageous to combine the bio-acoustic method, e.g. with shooting a 'very' pistol, but only **after** the call has stopped.

Some airports have successfully tested scaring birds by artificial sounds of various frequencies. In most cases this technique used stationary loudspeakers installed on the approach and along the runway. In 1982 this equipment was installed on Charles de Gaulle airport.

After pyrotechnical methods have been used, the birds rise and usually fly away faster than after the use of bio-acoustic techniques. Special Very pistol shells are used for scaring the birds (Figure 20-11). The first effect is the blast from the gun, then during the flight the shell glitters or smokes and at the end of the trajectory it explodes for a second time. The disadvantage is that the birds will be driven away only about 80 m and after a while they will return. It is better to work in two directions at the same time to herd the birds gradually from the danger area.

The gas gun automatic noise scaring device is a modified acetylene lamp with automatic fuse. The disadvantage is that explosions are periodically repeated. The birds find out very quickly that the gas gun is not a real danger for them and take little notice of it, unless this technique is sporadically complemented by e.g. live ammunition. Gas guns are therefore less used these days.

Among visual techniques of scaring are:

- driving off
- scarecrows, ribbons or flags
- lights.

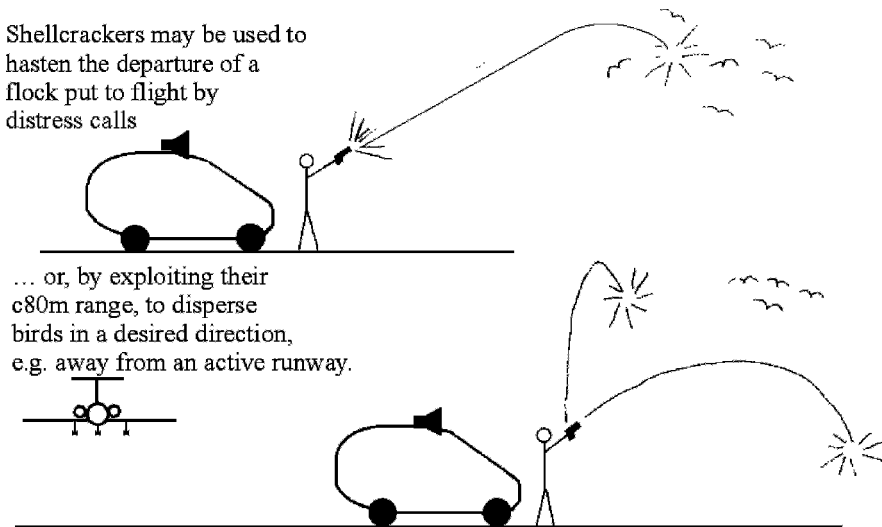

Figure 20-11 Scaring the birds by shell crackers

The most effective is if the birds are scared by people who face the birds and move their hands approximately 24 times a minute. They should be standing above the level of the birds' horizon (Figure 20-12). The birds consider them to be a large attacking predator. Visual techniques of scaring can be used in noise sensitive areas or when the use of pyrotechnics could cause a fire risk.

Static scarecrows or other mechanical means for scaring birds are not effective. Flashing lights, e.g. on the roof of a car, are used in combination with other methods, e.g. shooting. The birds gradually develop a conditioned reflex to this. A variation is to drive a car into the flock of birds while blowing the horn.

Among the mechanical techniques are nets or thin wires, which prevent the birds gaining access to food. It also includes using plastic or metal soffits on buildings, which are smooth and thus make building nests more difficult.

Endangered species of birds can be caught and relocated into their new locality. Bird catching is highly qualified and time consuming work, seldom done by airport employees.

The use of falconry, scaring birds by their natural enemies, namely birds of prey, are only seldom practised (Figure 20-13). The reasons are high acquisition and operational costs. In addition to the trained bird of prey, an all terrain vehicle, space for locating of the birds and training premises, aviaries, guns, hunting dog etc. also have to be available. In some countries falconry has been forbidden, because the only suitable predators are protected as endangered species. There is also the issue of the legal responsibility of the airport administrator for the damage in the event of a collision between an aircraft and the trained predator. The bird of prey cannot be used in bad weather and it is not effective for all species of birds.

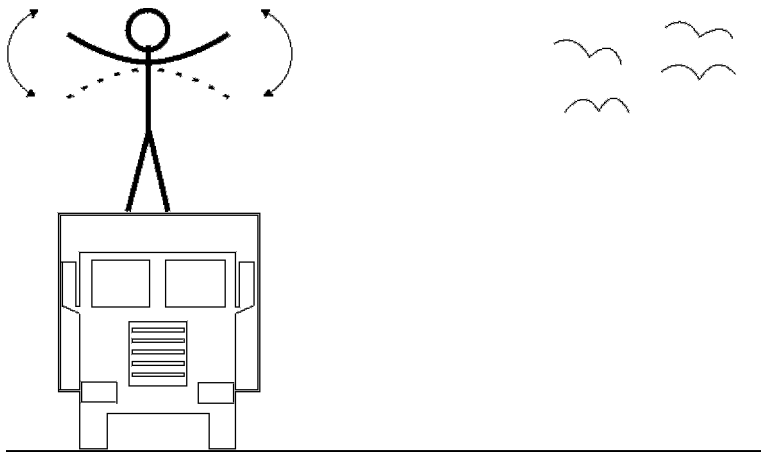

Figure 20-12 Scaring the birds by moving hands

Use of chemicals is strictly limited in many countries. These are mostly used to reduce the population of insects or rodents, which could serve as feed for the birds. In order to prevent nesting or resting of birds in high inaccessible places like flood-lighting masts, special pastes are used which repel the birds.

20.7.5 Ornithological Protection Zones

In some states ornithological protection zones are defined around airports. The objective of the declaration of ornithological protection zones is the limitation of bird strikes in the vicinity of airports, where the probability of bird strike is the highest.

In the inner ornithological protection zones, no dumps, stacks or silage must be located. The method of tilling agricultural soil will be agreed by the users of agricultural land with representatives of the airport administration. In some cases, areas belonging to the airport are

leased out for agriculture. In these cases it is necessary to agree planting of suitable products.



Figure 20-13 Falconry is highly professional work connected with high costs
(Photo: Courtesy Bratislava M.R. Štefánik Airport)

Outer ornithological protection zones surround the inner ornithological protection zones. It is possible to establish agricultural facilities, such as chicken and pheasant farms, cowsheds, centres for waste collection and processing plants, lakes and other structures and facilities in any significant quantity in this zone only with the approval of the Aviation Authority.

BIBLIOGRAPHY

- [1] ACI (1996): *Apron Safety Handbook*. Airports Council International, Geneva.
- [2] ACI Europe (1999): *Winter Services Yearbook*. Airports Council International-Europe, Brussels.
- [3] ACI Europe(1993): Technical & Safety Committee: *Winter Service White Booklet*. ACI Bruxeles.
- [4] ACI Europe(1995): *Environmental Handbook*. Airports Council International, European Region, Brussels. January.
- [5] ACI ROUNDUP (1992): N°2: *Letting the train take the strain*. Airports International. January/February, March.
- [6] ACI, (2005): *Survey on Apron Incidents/Accidents, Airports Council International*, December 2005, Geneva
- [7] AEA, (2005): *Recommendations for De-Icing/Anti-Icing of Aircraft on the Ground" - 19th Edition*. Asotiation of European Airlines, 2005
- [8] Airbus Industrie (2000): *Market Perspectives for Civil Jet Aircraft*. http://www.airbus.com/gmf99_1.html.
- [9] Airbus, (2006): *Global Market Forecast, 2006*, Airbus, Blagnac.
- [10] Airport Support Trading Supplement. (1991) *The Cost of Banning Duty Free*, April.
- [11] Airport Support. (1991): *Cashing in on Concession*. Trading Supplement. April.
- [12] Andrezi, B. (2006): *An Assessment of Safety, Operational and Other Key Issues Associated With Aircraft Ground De-Icing*, MSc Thesis, Cranfield University, School of Engineering, Department of Air Transport, Cranfield 2006
- [13] Anthony, R.R., Lindsay, C.H., Oke, J.L., Stevens, A:B. (1981): *Fire Extinguishants: Their history, properties and use*. ICAO Bulletin. October.
- [14] Arvai, E, S. (1993): *Telecommunications and business travel: the revolution has begun*. 8th International Workshop on Future Aviation Activities, pp28-31, Transportation Research Board, National Academy of Sciences, Sept. 13-15.
- [15] Ashford, N. (1993): *Current Development in European Airports*. Loughborough University of Technology, Loughborough.
- [16] Ashford, N., Bolland, S., Ndoh, N.N. (1993): *Planning Surveys for Modeling Airport Access*, Air Transport in Central Europe Conference, Jasná – Slovakia.

- [17] Ashford, N., H. P.M. Stanton and C. A. Moore. (1995): *Airport Operations*, McGraw-Hill.
- [18] Ashford, N., Moore, C.A. (1992): *Airport Finance*, Van Nostrand Reinhold.
- [19] Ashford, N., Wright, P.H. (1992): *Airport Engineering*, 3 rd, Wiley Interscience, New York.
- [20] Baier, V.M. (1993): *Flughafen Frankfurt/Main AG Well Prepared to Weather at Severe Winter*. ACI Winter Service Workshop, Budapest.
- [21] Bei, B. (1992): *The Growing Importance of Trading to the Quality of Airport Service*, First Airport Trading Conference AACI Europe, Paris.
- [22] Bienert, W. B.; Pravda, M. F.; Suelau, H. H.; Wolf, D. A., (2006): *Snow and ice removal from pavements using stored earth energy*, <http://adsabs.harvard.edu/abs/1974STIN...7527581B>, 28.12.2006
- [23] Birlie, K. (1993): *Aircraft de-icing*, 2nd ACI Europe Winter Service Workshop, Budapest.
- [24] Blow, C. (1996): *Airport terminals*. 2nd ed., Architectural Press, Oxford.
- [25] Boateng, E.A., Schweizer, F. (1994): *Disposal for Airport Waste, New World Transport '94*. Sterling Publishing Group PLC, London.
- [26] Boeing (2006): *Current market outlook*, Boeing Commercial Airplane Group, Seattle
- [27] Boeing (2000): *Current Market Outlook*. Boeing Commercial Airplane Group <http://www.boeing.com/commercial/cmo/5apc1.html>.
- [28] Bolkcom, Ch.; Elias, B.; Feickert, A. (2003): *Homeland Security: Protecting Airliners from Terrorist Missiles*, CRS Report for Congress, Seattle, 2003
- [29] Brooke, A. S., R. E. Caves and D. E. Pitfield. (1994): *Methodology for predicting European short-haul air transport demand from regional airports*. Journal of Air Transport Management, Vol. 1, No. 1, pp 37-46.
- [30] Buffet, A. (1987): *Jet Fuel Distribution*. ITA Magazine N°42, Paris.
- [31] Butterworth-Hayes, P. (1991): *Learning the Lessons of a Real Disaster*. Jane's Airport Review. January/February.
- [32] CAA, (2004): *Aircraft Fuelling and Fuel Installation Management*, UK, CAP 748, ISBN 0 86039 964 8, First edition July 2004, London
- [33] CAA, (2004): *Annual Statistics*, UK Civil Aviation Authority, London, 2004
- [34] CAA. (1981): *CAP 384 – Bird Control on Aerodromes*. London.

- [35] CAA. (1989): *CAP 556 – Passenger at the London area airports in 1984*. London.
- [36] Camille, A. (2006): *The history of air cargo and airmail from the 18th century*, www.historyofaircargo.com 12.11.2006
- [37] Caterpillar (2003): *Calculating UPS Life Cycle Costs*, LEDE3312, Caterpillar 2003, www.catups.com, 4.1.2006
- [38] Caterpillar (2003): *The Caterpillar Battery Free, Line-Interactive Uninterruptible Power Supply System*; Caterpillar 2003, www.catups.com, 4.1.2006
- [39] Caterpillar (2003): *UPS Environmental Safety*, Caterpillar 2003, www.catups.com, 4.1.2006
- [40] Caves R. E. and N. N. Ndoh. (1995): *Investigating the impact of air service supply on local demand - a causal analysis*. (with Environment and Planning) A, Vol. 27, pp 489-503.
- [41] Caves, R E; A D Kershaw and D P Rhodes. (1999): *Operations for airport approach noise control - flight procedures, aircraft certification and airport restrictions*, Transportation Research Record 1662, pages 48-54.
- [42] Caves, R. E. and G. D. Gosling. (1999): *Strategic Airport Planning*, Elsevier.
- [43] Caves, R. E., L. R. Jenkinson and A. S. Brooke. (1996): *Determinants of emission from ground operations of aircraft*. Paper presented to 20th Congress, International Council of the Aeronautical Sciences, Sorrento, Italy. September.
- [44] Československé aerolinie. (1983): *Technické podmínky pro používání močoviny (Karbamidu) na letištích ČSA, (Technical conditions for urea using) PZ-A1-02/36-LT*, ČSA Praha.
- [45] Čihař, J. (1973): *Letiště a jejich zařízení I. (Airports and its facilities I)*, Alfa Bratislava, Bratislava.
- [46] Čihař, J. (1975): *Letiště a jejich zařízení II. (Airports and its facilities II)*, Alfa Bratislava, Bratislava.
- [47] Collins, A. and A. Evans. (1994): *Aircraft noise and residential property values*. Journal of Transport Economics and Policy, May, 175-196.
- [48] Coogan, M. (1995): *Comparing airport ground access: a transatlantic look at an intermodal issue*. TR News 174, November-December, 2-10.
- [49] ČSN 650201: *Horlavé kvapaliny – prevádzky a sklady (Standards for flammable liquids)*
- [50] ČSN 757221: *Klasifikace jakosti povrchových vod (Standards for ground water*

quality)

- [51] ČSN 830915: *Ochrana vody pred ropnými látkami – objekty pre manipuláciu s ropnými látkami a ich skladovanie. (Standards for ground water protection against petroleum products):*
- [52] D'Albiac (1957): *London Airport*. Journal of the Royal Aeronautical Society, 61, April, 225-237.
- [53] de Neufville, R and Odoni, A (2003): *Airport systems – planning, design and management*, McGraw Hill, New York
- [54] de Neufville, R. (1976): *Airport System Planning*, The Macmillan press Ltd, London.
- [55] Deasy, C M. (1974): *Design for human affairs*, Wiley, New York.
- [56] Dempster, D. (1989): *Standardization Needed for Visual Docking Guidance*, Airport Forum. January.
- [57] DETR (1997): *Air Traffic Forecasts for the United Kingdom*, UK Department of Transport, Environment and the Regions.
- [58] DETR (1997): *Third party risk near airports and public safety zone policy*. (A report to the Department by consultants) UK Department of the Environment, Transport and the Regions, London, October.
- [59] DETR (1999): *Guidance on Airport Transport Forums and Airport Surface Access Strategies*. UK Department of the Environment, Transport and the Regions.
- [60] DfT, (2006): *The future of air transport progress report*, Department for Transport, London.
- [61] Doganis, R. (1991): *Flying off Course – The Economics of International Airlines*, Harper Collins Academic.
- [62] Doganis, R. (1992): *The Airport Business*, Routledge London.
- [63] DOT, (2005): National Highway Traffic Safety Administration: *Traffic Safety Facts 2005*, U.S. Department of Transportation, DOT HS 810 631, Washington 2005, <http://www-nrd.nhtsa.dot.gov/pdf/nrd-30/NCSA/TSFAnn/TSF2005EE.pdf>
- [64] Drahotka, J. (1990): *Letecký hluk, (Aircraft noise):* Letecký obzor, June.
- [65] DTp, (2001): *UK air freight study, Stage 2*, UK Department of Transport, London, August 2001
- [66] Dudáček, L. (1988): *Záchranná a požární služba. (Emergency services)*, Letecký obzor. February.

- [67] Duff, A. (1999): *Access – the Heathrow Case Study*. Loughborough University.
- [68] Easthill, A. (1987): *Mobile Fuel or Hydrants*, Airports International, February.
- [69] EC (2002): *Regulation 2320/2002 of European Parliament and Council on Common Rules in the Field of Civil Aviation Security*, Brussels
- [70] EC, (1998): *EEC Imposing an Obligation on Member States of the EEC to Maintain Minimum Stocks of Crude Oil and/or Petroleum Products*, Council Directive 98/93/EC of 14 December 1998 amending Directive 68/414
- [71] EC. (1996): *Impact of the Third Package of Air Transport Liberalisation Measures*. European Commission, Brussels.
- [72] ECAC (2002): *Policy Statement in the Field of Civil Aviation Security* ECAC.CEAC Doc No. 30., Paris
- [73] Eurocontrol, (2003): *Airport CDM Applications Guide*, Brussels
- [74] Eurocontrol, (2006): *Airport CDM Operational Concept Dokument, Edition 3.0*, May 2006
- [75] FAA, (2003): *Guidelines and Procedures for Maintenance of Airport Pavements*, AC 150/5380-6, US Department of Transportation, Federal Aviation Administration, Washington, DC.
- [76] FAA, (1976): *Use of Nondestructive Testing Devices in the Evaluation of Airport Pavements*, AC 150/5370-11, US Department of Transportation, Federal Aviation Administration, Washington, DC.
- [77] FAA, (19703): *Airport Drainage (7-1-70)*, AC 150/5320-5B, US Department of Transportation, Federal Aviation Administration, Washington, DC.
- [78] FAA, (1978): *Airport Landscaping for Noise Control Purposes (1-31-78)*, AC 150/5320-14, US Department of Transportation, Federal Aviation Administration, Washington, DC.
- [79] FAA, (1980): *Planning and Design of Airport Terminal Facilities at Non-Hub Locations (4-4-80)*, AC 150/5360-9, US Department of Transportation, Federal Aviation Administration, Washington, DC.
- [80] FAA, (1982): *Aircraft Fuel Storage, Handling, and Dispensing On Airports (8-27-82)*, AC 150/5230-4, US Department of Transportation, Federal Aviation Administration, Washington, DC.
- [81] FAA, (1983): *Airport Capacity And Delay (9-23-83)*, AC 50/5060-5, US Department of Transportation, Federal Aviation Administration, Washington, DC.

- [82] FAA, (1984): *Airport Emergency Medical Facilities and Services* (11-27-84), AC 150/5210-2A, US Department of Transportation, Federal Aviation Administration, Washington, DC.
- [83] FAA, (1984): *Announcement of Availability--Airport Landslide Simulation Model (ALSIM)* (4-24-84), AC 150/5360-10, US Department of Transportation, Federal Aviation Administration, Washington, DC.
- [84] FAA, (1985): *Aircraft Fire and Rescue Facilities and Extinguishing Agents* (1-28-85), AC 150/5210-6C, US Department of Transportation, Federal Aviation Administration, Washington, DC.
- [85] FAA, (1985): *Airport Master Plans* (6-85), AC 150/5070-6A, US Department of Transportation, Federal Aviation Administration, Washington, DC.
- [86] FAA, (1985): *Precision Approach Path Indicator (PAPI) Systems* (5-23-85): AC 150/5345-28D, Reprint incorporates Change 1, US Department of Transportation, Federal Aviation Administration, Washington, DC.
- [87] FAA, (1986): *Painting, Marking, and lighting of Vehicles Used on an Airport* (7-11-86), AC 150/5210-5B, US Department of Transportation, Federal Aviation Administration, Washington, DC.
- [88] FAA, (1987): *A Model Zoning Ordinance to Limit Height of Objects Around Airports* (12-14-87), AC 150/5190-4A, US Department of Transportation, Federal Aviation Administration, Washington, DC.
- [89] FAA, (1988): *Airport Safety Self-Inspection* (5-2-88), AC 150/5200-18B, US Department of Transportation, Federal Aviation Administration, Washington, DC.
- [90] FAA, (1988): *Planning and Design Guidelines for Airport Terminal Facilities*, AC 150/5360 –13 with amendments, US Federal Aviation Administration, Washington DC
- [91] FAA, (1989): *Airport Design* (9-29-89): (Consolidated reprint includes changes 1 thru 5), AC 150/5300-13, US Department of Transportation, Federal Aviation Administration, Washington, DC.
- [92] FAA, (1991): *Management of Airport Industrial Waste* (2-11-91): 150/5320-15, Chg. 1 (4-22-97), AC 150/5320-15, US Department of Transportation, Federal Aviation Administration, Washington, DC.
- [93] FAA, (1991): *Runway Length Requirements for Airport Design* (1-29-90): (Consolidated reprint includes Change 1 dated 3-11-91) AC 150/5325-4A, US Department of Transportation, Federal Aviation Administration, Washington, DC.
- [94] FAA, (1991): *Standards for Airport Sign Systems* (7-31-91): AC 150/5340-18C,

- 150/5340-18C, Chg. 1 (11-13-91), US Department of Transportation, Federal Aviation Administration, Washington, DC.
- [95] FAA, (1994): *Heliport Design* (1-20-94), AC 150/5390-2A, US Department of Transportation, Federal Aviation Administration, Washington, DC.
- [96] FAA, (1995): *Airport Winter Safety and Operations* (10-1-91), AC 150/5200-30A, (3-27-95), US Department of Transportation, Federal Aviation Administration, Washington, DC.
- [97] FAA, (1996): *Airport Pavement Design and Evaluation* (1-30-96), AC 150/5320-6D, US Department of Transportation, Federal Aviation Administration, Washington, DC.
- [98] FAA, (1997): *Guide Specification for Water/Foam Aircraft Rescue and Firefighting Vehicles* (10-20-97), AC 150/5220-10B, US Department of Transportation, Federal Aviation Administration, Washington, DC.
- [99] FAA, (1997): *Hazardous Wildlife Attractants on or Near Airports* (5-1-97), AC 150/5200-33, US Department of Transportation, Federal Aviation Administration, Washington, DC.
- [100] FAA, (1997): *Measurement, Construction, and Maintenance of Skid Resistant Airport Pavement Surfaces* (3-18-97), AC 150/5320-12C, US Department of Transportation, Federal Aviation Administration, Washington, DC.
- [101] FAA, (1997): *Procedures for the Approval of Category II Operations and Lower than Standard Category I Operations on Type I Facilities*, Order 8400.13, US Department of Transportation, Federal Aviation Administration, Washington, DC.
- [102] FAA, (1998): *Engineered Materials Arresting Systems (EMAS) for Aircraft Overruns*. (8-21-98), AC 150/5220-22, US Department of Transportation, Federal Aviation Administration, Washington, DC.
- [103] FAA, (1998): *National Fire Protection Association (NFPA) Aircraft Familiarization Charts Manual* (3-6-98) US Department of Transportation, Federal Aviation Administration, Washington, DC.
- [104] FAA, (1999): AC 150/5200-30A, Chg. 3 (11-30-98) AC 150/5200-30A, Change 4 (11-15-99), US Department of Transportation, Federal Aviation Administration, Washington, DC.
- [105] FAA, (1999): *Access to Airports by Individuals with Disabilities* (6-30-99), AC 150/5360-14, US Department of Transportation, Federal Aviation Administration, Washington, DC.
- [106] FAA, (1999): *Airport Emergency Plan* (9-30-99), AC 150/5200-31A, US Department

of Transportation, Federal Aviation Administration, Washington, DC.

- [107] FAA, (1999): *Criteria for Approval of Category III Weather Minima for Takeoff, Landing, and Rollout*, AC 120-28D, US Department of Transportation, Federal Aviation Administration, Washington, DC.
- [108] FAA, (1999): *Design of Aircraft Deicing Facilities*, AC 150/5300-14, Chg. 1 (8-13-99): Change 1, US Department of Transportation, Federal Aviation Administration, Washington, DC.
- [109] FAA, (1999): *Standards for Airport Markings* (8-31-99), AC 150/5340-1H, US Department of Transportation, Federal Aviation Administration, Washington, DC.
- [110] FAA, (2000): *Criteria for Approval of Nonprecision, Category I, and Category II Weather Minima for Takeoff, Approach, and Landing*, AC 120-29A, US Department of Transportation, Federal Aviation Administration, Washington, DC.
- [111] FAA, (2004): *Aircraft Fire Extinguishing Agents*, AC 150/5210-6D, US Department of Transportation, Federal Aviation Administration, Washington, DC. 7.8.2004
- [112] FAA, (2004): *Aircraft Fuel Storage, Handling, and Dispensing on Airports*, AC 150/5230-4A, US Department of Transportation, Federal Aviation Administration, Washington, DC. 18.06.2004
- [113] FAA, (2004): US Federal Aviation Administration, Advisory Circular, US Department of Transportation, Federal Aviation Administration, Washington, DC.
- [114] FAA, (2006): *National Plan for Integrated Airport Systems*, US Department of Transportation, Federal Aviation Administration, Washington, DC.
- [115] FAA, (2006): www.faa.gov/data_statistics/aviation, US Department of Transportation, Federal Aviation Administration, Washington, DC.
- [116] FAA. (1992): *FAA Integrated Noise Model Version 3.1*. DOT/FAA/EE-92/02 Office of Environment and Energy Washington DC, June.
- [117] FAA. (1996): *FAA Integrated Noise Model Version 5.1*. FAA-AEE-96-02. Office of Environment and Energy Washington DC.
- [118] Fábera, J., and M. Kyncl. (1977): *Dopravní letiště (Transport airports)*, NADAS. Praha.
- [119] Fergusson, M. (1995): *Environment and Air Transport in Europe*. In conference: Environmental Aspects of Air Transport, Royal Aeronautical Society, London, 19 September.

- [120] Fischer, M.M., P. Nijkamp and Y.Y. Papageorgiou, eds (1990): *Spatial Choices and Processes*, Elsevier Science Publishers B.V.
- [121] Flight International, (1993): *BA Drives to Retain MLS as Main System*, 31 March - 6 April 1993, 6; "Final Approach," Flight International, 31 March - 6 April 1993, 34-36.
- [122] Forssell, B., (1991): *Radionavigation systems*, Prentice Hall International Ltd., 1991
- [123] Gabriel, P. (1985): *Ornitologická ochrana letiště Kunovice, (Ornithological protection of Kunovice airport)*: VŠDS Žilina, Žilina.
- [124] Gangl, S. (1992): *The Financial Importance of Airport Trading in the Creation of Airport Capacity*. First Airport Trading Conference AACI Europe, Paris.
- [125] Gardiner, J.; Humphreys, J.; Ison, S. (2005): *Freight operators' choice of airport: a three stage process*, Transport Reviews, Vol. 25, No. 1, pp. 85 – 102, Jan. 2005
- [126] Gero, D., (1997): *Flights of Terror*, Patric Stephens Ltd., England 1997
- [127] Gibson, B. (1992): *The Role of High Street Names in Airport Trading*, First Airport Trading Conference AACI Europe, Paris.
- [128] Gosling, G. D. (1997): *Airport ground Access and Intermodal Interface*. Transportation Research Record 1600, pp. 10-17.
- [129] Gould, R. (1994): *Runway De-icer Revolution Gathers Pace*, Jane's Airport Review, April.
- [130] Graham, A. (1991): *Airport Economics*. Polytechnic of Central London, London.
- [131] Graham, A.. (2000): *Demand for leisure travel and limits to growth*. Journal of Air Transport Management, Vol. 6, No. 2, pp. 109-118.
- [132] Gray, F.J. (1991): *Developing non-aeronautical Income*, Sypher: Mueller International Inc., Loughborough University of Technology, Loughborough.
- [133] Grover, J.H.H. (1990): *Airline Route Planning*, BSP Professional Books.
- [134] Halse, J. (1999): *Concessions space, lecture to Short Course in Airport Airside and Landside Design*, Dept of Civil and Building Engineering, Loughborough University, November.
- [135] Hill, R.E. (1990): *Airport Security Beyond the 1990s*, Closing the Gate on the Terrorists, Airports into the 21st Century Conference, Hong Kong.
- [136] Hill, R.G., Howell, W.D., Sarkos, C.P. (1982): *Full-scale Wide-body Test Article Employed to Study Post Crash Fuel Fires*, ICAO Bulletin, October.
- [137] Honeybun, M. (2000): *Fuel Supply to Airports*, International Airport Review, Vol. 4,

Issue 1, pp. 17-24.

- [138] Hopkins, H. (1985): *Cold Cures in Helsinki*, Flight International, 12 October.
- [139] Horonjeff, R. and F. X. Mckelvey. (1994): *Planning and Design of Airports*, 4th ed. McGraw-Hill, New York.
- [140] http://en.wikipedia.org/wiki/Instrument_Landing_System#History 6.1.2007
- [141] http://en.wikipedia.org/wiki/Microwave_Landing_System#History, 8.1.2007
- [142] http://en.wikipedia.org/wiki/VHF_omnidirectional_range#Future, 10.1.2007
- [143] http://www.airsafe.com/events/last_15.htm; AirSafe.com: The Most Recent Fatal Airline Events,
- [144] http://www.centennialofflight.gov/essay/Government_Role/landing_nav/POL14.htm, 6.1.2007
- [145] http://www.consilium.europa.eu/ueDocs/cms_Data/docs/pressData/en/misc/89962.pdf (PE-CONS 3681/05, 8510/06 ADD1), 24.1.2007
- [146] <http://www.gaavionics.com/tls.htm>, 13.1.2006
- [147] <http://www.nationmaster.com/country/us-united-states/crime> NationMaster.com: North America, United States Crime Statistics, 7.12.2006
- [148] <http://www.nssl.noaa.gov/papers/techmemos/NWS-SR-193/techmemo-sr193-2.html#table1>, NOAA, (1995): Technical Memorandum NWS SR-193: Lightning Fatalities, Injuries, And Damage Reports In The United States From 1959-1994, 7.12.2006
- [149] Hudson, G. M. (1982): *Airport Environmental Planning*, Loughborough University.
- [150] Hughes, C.V. (1990): *More Foam Needed*, Jane's Airport review.
- [151] IATA, (2004): *Airport Development Reference Manual*, 9th ed., International Air Transport Association, Montreal, 2004
- [152] IATA/*: (1992): *Air Transport & The Environment*, IATA, Geneva, /* International Air Transport Association.
- [153] ICAO (1980): *Airport Services Manual Part 7 – Airport Emergency Planning*, ICAO Doc 9137-An/898, 1st edition, Montreal.
- [154] ICAO (1983): *Airport Services Manual, Part 6 – Control of Obstacles*, ICAO Doc 9137-An/898, 2nd edition, Montreal.
- [155] ICAO (1984): *Aerodrome Design Manual*, Part 1, Runways, Doc 9157-AN/901, 2nd ed.

- [156] ICAO (1984): *Airport Services Manual, Part 2 – Pavement Surface Conditions*, ICAO Doc 9137-An/898, Part 2, 2nd edition, Montreal.
- [157] ICAO (1984): *Airport Services Manual, Part 8 – Airport Operational Services*, ICAO Doc 9137-An/898, Part 8, 1st edition, Montreal.
- [158] ICAO (1984): *Airport Services Manual, Part 9 – Airport Maintenance Practices*, ICAO Doc 9137-An/898, 1st edition, Montreal.
- [159] ICAO (1985): *Airport Planning Manual, Part 2, Land Use and Environmental Control*, 2nd ed., International Civil Aviation Organisation, Montreal.
- [160] ICAO (1986): *Airport Services Manual, Part 5 - Removal of Disabled Aircraft*, ICAO Doc 9137-An/898, part 5, 2nd edition, Montreal.
- [161] ICAO (1986): *Manual on air traffic forecasting*, 2nd ed. Doc. 8991 - AT/722/2, International Civil Aviation Organisation, Montreal.
- [162] ICAO (1987): *Airport Planning Manual, Part 1, Master Planning*, 2nd ed. International Civil Aviation Organisation, Montreal.
- [163] ICAO (1989): *Manual on the ICAO Bird Strike Information System (IBIS)*, ICAO Doc 9332-An/909, 3-rd edition, Montreal.
- [164] ICAO (1990): *Airport Services Manual, Part 1 – Rescue and Fire Fighting*, ICAO Doc 9137-An/898, Part 1, 3-rd edition, Montreal.
- [165] ICAO (1991): *Airport Services Manual, Part 3 – Bird Control and Reduction*, ICAO Doc 9137-An/898, 3-rd edition, Montreal.
- [166] ICAO (1993): *Aerodrome Design Manual, Part 3, Pavements*, Doc 9157-AN/901, 1991, Corrigendum N 1, 1993, International Civil Aviation Organisation, Montreal
- [167] ICAO (1997): *Outlook for air transport to the year 2005*, Circular 270-AT/111, International Civil Aviation Organisation, Montreal.
- [168] ICAO (1999): *Aerodromes – Annex 14 Volume I Aerodrome Design and Operations*, Montreal, July.
- [169] ICAO (1999): *Aircraft engine emissions. Annex 16 to the Convention on International Civil Aviation, Vol. 2*, 2nd ed., Amendment 4, International Civil Aviation Organisation, Montreal, July.
- [170] ICAO (1999): *Environmental Protection. Annex 16 to the Convention on International Civil Aviation, Vol. 1, Aircraft Noise*, 3rd ed., Amendment 6, International Civil Aviation Organisation, Montreal.

- [171] ICAO (2001): *Air Traffic Management, Procedures for Air Navigation Services, Doc 4444 ATM/501*, 14th ed. 2001, International Civil Aviation Organisation, Montreal.
- [172] ICAO (2006): *Manual on Air Traffic Forecasting*, 3rd ed. Doc 8991, International Civil Aviation Organisation, Montreal.
- [173] ICAO Journal (1990): *Air transport in the European Community. The hardcore problem*. December.
- [174] ICAO, (2000): *Manual of Aircraft Ground De-Icing/Anti-Icing Operations*, 2nd ed, Doc 9640-AN/940, International Civil Aviation Organisation, Montreal
- [175] ICAO, (1994): *Airport Services Manual, Part 2 Pavement Surface Conditions, Chapter 7 Snow removal and Ice Control*, 3rd ed. (ICAO Doc 9137-AN/898), International Civil Aviation Organisation, Montreal
- [176] ICAO, (1993): *Aerodrome design manual, Part 4, Visual aids*, 3rd ed, Doc 9157-AN/901 Part 4, Montreal 1993
- [177] ICAO, (1995): *Annex 14, Aerodromes, Volume II, Heliports*, 2nd ed., International Civil Aviation Organisation, July 1995, Montreal
- [178] ICAO, (1996): *Aeronautical Telecommunications, Annex 10, Volume I - Radio Navigation Aids*, Fifth Edition, International Civil Aviation Organisation, Montreal July 1996,
- [179] ICAO, (2004): *Annex 14, Aerodromes, Volume I, Aerodrome Design and Operations*, 4th ed., International Civil Aviation Organisation, July, 2004, Montreal
- [180] ICAO, (2004): *Outlook for air transport to the year 2015*, Circular 304, International Civil Aviation Organisation, Montreal
- [181] ICAO, (2005): *European Guidance Material on Aerodrome Operations Under Limited Visibility Conditions*, EUR Doc 013, 2nd ed., International Civil Aviation Organisation, European Air Navigation Planning Group, Paris, April 2005
- [182] ICAO, (2006): *Safety Management Manual (SMM)*, Doc 9859 AN/460, 1st ed. International Civil Aviation Organisation, Montreal, 2006
- [183] Ilkovič, D. (1959): *Fyzika (Physics)*, SVTL Bratislava.
- [184] International Civil Airports Association. (1990): *European Airports: their future*, Paris.
- [185] Juttner, U. (2005): *Supply chain risk management – understanding the business requirement from a practitioner perspective*, Int Jnl of Logistics Management, 16, 1, pp 120-141, 2005

- [186] Kazda, A. (1988): *Vyhodnocovanie prevádzkovej využiteľnosti letísk, práca, (Methods of usability factor assessment)* VŠDS Žilina, Žilina.
- [187] Kazda, A. (1992): Airports in the Czechoslovakia faced with the next millenium requirements, STU The 5th ISC, Bratislava.
- [188] Keane, A.G. (1990): *Aviation Security – the Background*, Airport Forum 3.
- [189] Kevický, D., Kalaššová, A. (2003): *Augmented satellite navigation systems*, Conference ITS' 03 Prague, March 11-12, 2003, Prague
- [190] KIRKLAND, I D and R E CAVES. (1999): *Runway overrun risk assessment*, Transportation Research Record 1662, pages 67-73.
- [191] Kotler, P. (1988): *Marketing Management: Analysis, Planning, Implementations and Control*, 7 th ed., Prentice Hall, Englewood Cliffs, New Jersey.
- [192] Lemer, A C. (1992): *Measuring performance of airport passenger terminals*, *Transpn. Res. A*, Vol. 26A, No. 1, pp.37-45.
- [193] Lodge, J.E. (1991): *Airport Emergency Procedures*, Loughborough University of Technology, Loughborough.
- [194] Loveridge, Denis; Luke Georghiou and Maria Nedeva. (1995): *United Kingdom Technology Foresight Programme*, Delphi Survey, Office of Science and Technology, PREST, University of Manchester.
- [195] Lythgoe, W. F.; Wordman, M., (2002): *Demand for rail travel to and from airports*, *Transportation* 29, pp 125 – 143.
- [196] Mahony, H, (2006): *EU aviation emissions plan softened*, EU Observer / Brussels, 19.12.2006 - 09:30 CET
- [197] Maiden, S. (1990): *Know Your Customer Through Passenger Surveys*, Airports Technology International, London.
- [198] Manchester Airport, (1999): *Environmental report*, 1998-99.
- [199] Mortimer, L.F. (1992): *Ambitious Programme of Future Work to be Undertaken by CAEP*, ICAO. August.
- [200] Moses, A. (2006): *Lost in transit no more*, Asher November 30, 2006 - 2:16PM <http://www.smh.com.au/news/technology/lost-in-transit-no-more/2006/11/30/1164777706811.html>, 26.12.2006
- [201] Moutinho, Luiz and Stephen F. Witt. (1995): *Forecasting the tourism environment using a consensus approach*, J. Travel Research, Spring, pp.46-50.

- [202] Mulvey, S., (2006): *A deal on the transfer of data about air passengers leaving the European Union for the US has run out, following the collapse of talks on its renewal.* EU reporter, BBC News, October 6, 2006
- [203] Odoni, A. R., de Neufville, R. (1992): *Passenger terminal design*, Transpn. Res. A, Vol. 26A, No. 1, pp. 27-35.
- [204] Ohashi, H.; Tae-Seung, K.; Tae, H. O.; Chunyan, Y.; (2005): *Choice of air cargo transshipment airport: an approach to air cargo traffic to and from Asia*, Jnl. Air Transport Management, 11 (2005), 149-159
- [205] Oliver, J. (1999): *Guiding light*, Passenger Terminal World, Oct., pp 65-69.
- [206] Ollerhead, J. B. (1995): *Assessing the impact of aircraft noise upon the community.* Paper presented to conference: Environmental Aspects of Air Transport, Royal Aeronautical Society, London, September.
- [207] Orrell, K. (1989): *Airport Commercial Review – a Blueprint for the Future*, Airport Technology International, London.
- [208] Oslo Airport, (2005): *Express Train survey data*, Oslo 2005
- [209] Pavlíček, M. (1980): *Hluková zátěž na odbavovací ploše, (Noise load on apron):* Letecký obzor 3.
- [210] Pearsons, K. S., D. S. Barber, B. G. Tabachnick and S. Fidell. (1995): *Predicting noise-induced sleep disturbance.* Journal of the Acoustical Society of America, 97(1), January, 331-338.
- [211] Pedoe, N. T., D. W. Raper And J. M. W. Holden. (1996): eds.: *Environmental management at airports - liabilities and social responsibilities.* Thomas Telford, London.
- [212] Peen, J., T. Rallis. (1990): *The Traffic Connections Between Airports and City Centers*, Journal of Advanced Transportattion Vol. 24, N^o.3.
- [213] Phipps, D. (1991): *The Management of Aviation Security*, Pitman.
- [214] Pilling, M. (1994): *Why Airlines Should Turn off APUs*, Airports International, July/August.
- [215] Schönrock, B. (1989): *The challenges of the 1990's are airports equipped for them?* ICAA/EUR9/Additional Document, Jerusalem.
- [216] Seneviratne, P N And Martel, N. (1995): *Space standards for sizing air terminal check-in areas*, Jnl. of Transportation Engineering, Vol. 121, No. 2, pp. 141-149.

- [217] Shaw, S. (1989): *Airline marketing and Management*, Pitman, 3rd ed.
- [218] SITA (2005): *World Statistics*, SITA
- [219] Slovak Airlines, (2005): *De- /Anti-Icing Procedures*, Bratislava, 2005
- [220] Smith, M. J. T. (1989a) *Aircraft noise*. Cambridge University Press, Cambridge, England.
- [221] Srnský, S. (1986): *Starosti s leteckým petrolejom, (Problems with aviation kerosene)* L+K 11/86, Praha.
- [222] Stadler, G. (1992): *Air Transport and Environment*, Academy Graz.
- [223] Steffen, M. (1993): *The Munich Experience*, 2nd ACI Europe Winter Service Workshop, Budapest.
- [224] Stefl, B. A. (1990): *Aircraft Anti-icing Fluid Technology and Application*, Airports Technology Internationals, London.
- [225] Subramanian, N. V. (1997): *Airport safety problems and solutions*, in proceedings of ACI Airport Operational Safety Conference, Civil Aviation Authority of Singapore, April.
- [226] Taneja, N. K. (1979): *The Commercial Airline Industry*, D.C. Heath and Company, Toronto.
- [227] The Economist Newspapers, (2006): *The dirty sky - The dirty sky; Aircraft emissions*, Ltd. June 10, 2006 U.S. Edition
- [228] Tošić, V. (1993): *Modelling passenger Terminal Operations at Medium-Sized Airports*, The Air Transport in Central Europe Conference – Jasná, VŠDS Žilina.
- [229] Transport Canada (1992): *Small terminal building (STEP program) planning and design guide*, Transport Canada, Ottawa.
- [230] Trunov, O. K. (1989): *Beating the Aircraft Ground Icing Problem*, Airports Technology International, London.
- [231] Tyler, C. (1999): *Airport access for all*, Airport World, Vol. 4, Issue 6, Dec. 1999/Jan 2000, pp 56-59.
- [232] Walker, Ch. (1991): *Less Lighting on the Road to Cat 3*, Airports International, October.
- [233] Webster, B., (2006): *Transport Correspondent Gatwick Express is axed to make room for more commuters*, The Times (London), Home News; Pg. 8; February 3, 2006
- [234] Wikipedia; http://en.wikipedia.org/wiki/Tokyo_Monorail; 31.12.2006

- [235] Zukovsky, J (1996): *Building for air travel*, Prestel.

INDEX

- μ-meter, 29
- ACARE, 458
- ACI, 176
- ACMI, 217
- ACN-PCN, 5, 18, 20
- active surfactants, 199
- Addressable Switching Device (ASD), 364
- Advanced Passenger Processing (APP), 260
- Aerodrome category, 431
- Aéroport de Paris, 251
- AFTN, 405
- AGA, 13
- AGNIS, 194
- Air Foyle, 218
- Air Traffic Flow and Capacity Management (ATFCM), 189
- Air Train, 326
- Airbus, 24
- ALPA ATA, 346
- al-Qaida, 284
- Amsterdam Schiphol, 6, 34, 35, 127, 219, **274**, 291, 313, 323
- Anchorage, 219, 220
- Anti-icing fluids, 423
- ASDA, 83
- A-SMGCS, 57, 190, **365**, 380, **397**, 448
- Athens, 9, 238
- Atlanta Hartsfield, 6, 124, 128, 191, 241, 249, **279**
- ATM Strategy, 188
- Automatic Ticket and Boarding (ATB), 268
- Auxiliary Power Unit (APU), 175, 183
- BAG TRAX, 259
- baggage reconciliation, 274, 184, 296, **300**
- balanced field length, 71
- Baltimore, 313, 418
- Beijing, 177
- Beirut, 238
- Berlin Brandenburg, 249
- biometric, 269, 298
- Bird Strike Information System (IBIS), 491
- Birmingham, **279**, 322, 454, 484
- blind landings, 384
- Bonn, 327
- Bordeaux/Merignac, 494
- Boston Logan, 105
- brake energy, 82
- braking effect, 164. **170**, 333
- Bratislava M.R. Štefánik, 48, 135
- Bremen, 322
- Bristol, 488
- British Airways, 235
- Brussels, 29, 220, 239, 313
- Buncefield Fuel Depot, 202
- busy hour, 251
- California Bearing Ratio (CBR), 6
- CALVERT, 346
- carbon dioxide, 434
- Cargolux, 218
- Category I, II, III, **50-52**, 115, 341, 349, 352, 370, 377, 388, 337
- Caterpillar, 374
- Cathay, 220
- CBR, 21

- CCMS-GROUP, 481
- Charles de Gaulle, 6, 128, 202, 249, 289, 313, 320, 322, 497
- Chicago, 6, 10, 219, 312, **326**
- Collision Risk Model (CRM), 64
- Cologne, 327
- Common User Self Service (CUSS), 255
- Constant Current Regulators (CCR), 348, 365, **377**, 380
- contraction joints, 10
- control time, 430
- Copenhagen, 241, 313, 322
- critical aeroplane, 431
- cryogenic fuels, 212
- CSA Cargo, 226
- cul-de-sac, 127
- CUSS system, 268
- CUTE, 267
- Dallas/Fort Worth, 6, 250
- decision height (DH), 53, **54**
- decision speed, 79
- de-icing fluids, 422
- Denver, 245, 249, **279**, 326
- deregulation, 6
- Deutsche Bundesbahn, 327
- Deutsche Post, 238
- DHL, 218, 220, 238, 285
- dichroic, 351
- diesel generators, 372
- disabled, 271
- doppler, 392
- dry chemical powders, 434
- DTR 2000 system, 296
- Dubai, 241
- Dublin, 256
- Durst method, 49, 52
- Düsseldorf, 327
- dwelt time, 262
- dynamic modulus of elasticity, 6
- EASA, 16
- East Midlands Airport, 105, 135, 239, 322, 477
- ECAC, 287, 293, 458
- edge enhancement, 307
- Effective Perceived Noise Level, 466
- EIA, 459
- elasticities, 26
- Electronic Data Interchange (EDI), 218
- Emissions and Dispersion Modelling System (EDMS), 486
- engine failure, 77
- Engineered Material Arresting System (EMAS), 103
- environment, 46, 425
- Environmental Impact Assessment (EIA), 458
- Equivalent Continuous Sound Level, 465
- Equivalent Gates (EQA), 251
- Equivalent Single Isolated Wheel Load, 17
- EU Directive 2320/2002, 287
- Euro-tunnel, 326
- eutectic temperature, 414
- exhaust emissions, 177
- expansion joints, 10
- Express Group plc., 322
- FAA Airfield Capacity Model, 67
- FAA, 16, 24, 38, 52, 107, 114, 248, 251, 391, 430
- FATO, 63, 359
- Fedex, 218, 220
- fibre-turf, 4
- field length, 81
- Fletcher-Munson's curves, 463
- flight procedures, 462, 484

- fluoroprotein foam, 432
 foam blanket, 451
 frangibility, 340, 342
 Frankfurt Hahn, 9
 Frankfurt, 6, 187, 210, 220, 243, 312, 313, 322, 324, **327**, 487
 free ramp concept, 207
 Fresnel lens, 345
 friction coefficient, 2
 Galileo satellite navigation system, 391
 Gamma Enhancement, 307
 Gate-to-Gate, 188
 Gatwick Express, 324
 GDP, 40
 Geneva, 323
 Gibb's phase rule, 414
 glide path, 355, 356, **387**
 glideslope, 484
 Global Positioning System (GPS), 390
 glycol, 417, 421, 425
 Goldhofer, 187
 GRIPTESTER, 33
 Gross performance, 76
 Ground Controlled Approach (GCA), 396
 Ground Proximity Warning System (GPWS), 484
 HAL project, 454
 Halotron®, 434
 Hamburg, 320
 Haneda, 312
 Heathrow Express, 315, 324
 heliports, 62
 hold over time (HOT), 423
 Honeywell, 195
 Hong Kong - Chep Lap Kok, 9, 220, 270, 312, 313, 322
 Honolulu, 279
 hubbing, 128, 249
 hydrant system, 207
 hydrogen, 212
 IATA International Airlines Technical Pool, 454
 IATA, 23, 131, 181, 215, 236, 248, 251, 256, 289, 302
 ICAO Collision Risk Model, 63
 ICAO, 7, 13, 14, 20, 24, 36, 40, 52, 102, 114, 231, 249, 287, 485
 ILS critical and sensitive areas, 115, 388
 InfraTek system, 426
 inset light, 343
 Instrument Flight Rules (IFR), 383
 Instrument Landing System (ILS), **55**, **57**, 97, 102, 404, 484
 JAA, 52
 Jakarta, 238
 JAL, 220
 JAR – OPS, 54
 JAR/FAR requirements, 83
 jet blast, 124
 Jet Blue, 250
 kerb, 319
 Kinetic Power Cell, 374
 Köln-Bonn, 323
 Korean, 220
 Kuala Lumpur, 9, 250, 279, 322
 La Guardia, 1, 105, 295, 312
 land use category, 473
 landscaping, 488
 Las Vegas, 6
 Leipzig, 220
 Level Of Service (LOS), **252**, 253, 255, 260, 262
 Light Emitting Diode (LED), **338**, 362, **368**
 Lisbon, 9

- localizer (LLZ), 385
 Lockerbie, 5, **283**, 300, 444
 London Gatwick, 31, 32, 203, 247, 261, **278**, 312, 313, 484
 London Heathrow, 6, 9, **10**, 29, 31, 38, 39, 113, 135, 127, 202, 203, 219, 235, 256, 259, 262, 265, 284, 291, 312, 313, 322, 444, 448, 484
 London Heathrow-Terminal 5, 11, 125, 249
 London Stansted, 32, 203, 239, 249, 256, 270, 454, 484
 Los Angeles, 6, 123, 220, 313, 321
 Louisville, 220
 Low Cost Carriers (LCC), 35, 38, 40, 216, 250, 253, 266
 Low Visibility Procedures (LVP), **54**, 58, 389
 Low Visibility Take-Off, 54
 Lufthansa, 220, **327**
 Luton, 32
 Lyon, 250
 Macau, 9
 Madrid Barajas, 9, 313, 322
 Magadan airport, 411
 Magal, 296, **297**
 Manchester, 9, 29, 209, 256, 313, 322, 416, 487
 MANPAD, 284
 Marseille, 29
 MARTA, 326
 Maximum Take-off Mass (MTOM), 73
 measured performance, 75
 Memphis, 220
 metro, 322
 Milan Linate, 123, 125
 Milan Malpensa, 9
 minimum stocks of crude oil, 201
 MLS Landing Clearance Trigger Line, 57
 MLS, 55, 57
 modulus of concrete elasticity, 15
 modulus of reaction of the subgrade 'k', 5
 Monorail, 327
 Montreal agreement, 287
 Munich, 9, 123, 124, 313, 324, 370, 382
 NATO, 481
 net performance, 76
 New York - J.F. Kennedy, 105, 291, 250, 295, 312, 313
 Newark, 312, 460
 non-Newtonian fluids, 423
 NZ² system, 374
 Oakland, 247
 Obstacle Free Zone (OFZ), 56
 oil crisis, 212
 one-step procedure, 424
 Orlyval, 328
 Osaka - Kansai, 9, 243, 250, 313
 Oslo – Gardermoen, 9, 249, 322, 324,
 Parallax Aircraft Parking Aid (PAPA), 194
 Paris - Orly, 29, 312, 313, 284, **328**
 payload, 74
 peak hour, 108, 251
 Perceived Noise Level, 464
 Portland Cement Association, 20
 Potassium acetate, 417
 PowerPush, 185
 Praha-Ruzyně, 2, 204, 320, 370
 Precision Approach Radar (PAR), 97
 Precision approach, 52
 propensity to fly (ptf), 37, 25
 protein foam, 432
 push-back, 132
 Quick Change, 215
 Radio Frequency Identification Technology

- (RFID), 259, **301**
- radius of relative stiffness, 14
- Rail and Fly rate, 327
- Rams Plus, 66
- recycling, 454
- reference field length, 71
- reflectance, 332
- relative slippage, 32
- response time, 429
- Rio de Janeiro Galeao, 123, 262, 265
- Roissy-Charles de Gaulle, 9, 124, 312
- Rome (FCO), 283, 313
- Rosenbauer, 454
- Royal Mail, 239
- Runway Visual Range (RVR), 51, 53, 54, 98, 352
- Saab Friction Tester, 29, 34
- Safegate, 192, 196
- SAGA, 359
- Samsung, 219
- San Francisco, 326
- São Paulo Guarulhos, 203
- SATS, 235
- Schengen, 266, **298**
- secondary radar, 373
- sedimentation, 200
- Seoul (GIM), 313
- Seoul Incheon, 219, 220
- serial distribution system, 348
- Service Level Agreements (SLA), 246
- service life, 376
- Shanghai International Airport, 220, 328
- Shannon, 261
- Side Marker Board (SMB), 194
- SIMMOD, 65
- Singapore Changi, 220, 235, 241, 250
- SITA, 273
- Skiddometer, 33
- Slant Visual Range (SVR), 54
- SNOWFREE, 418
- sodium acetate, 417
- Sound Exposure Level, 465
- SSR transponder, 400
- Standard Busy Rate (SBR), 251
- static standby, 375
- Stockholm-Arlanda, 179, 207, 313, 322, 448
- Stuttgart, 322
- surface-to-air missile (SAM), 284
- Swiss Railways, 327
- Sydney, 313
- TGV, 29, 323
- Threat Image Projection (TIP), 308
- TLOF, 360
- TNT, 218
- TODA, 83, 100
- Tokyo Haneda, 327
- Tokyo Narita, 6, 220, 219
- TORA, 83, 100
- Toronto, 289, **326**
- Total Airspace & Airport Modeller, 65
- towbar, 184
- towbarless, 184
- Transrapid, 328
- TUB TRAX, 259
- turnround times, 175, 197, **276**
- two-step procedure, 424
- typical peak hour passengers (TPHP), 251, 252, 255
- tyre speed, 82
- UK Department for Transport (DfT), 40
- ULD, 227
- unburned hydrocarbons (HC), 211, 485
- Uninterruptible Power Supply (UPS), 373
- Unit Load Devices (ULDs), 221

unlawful interference, 136

UPS, 218, 220

urea, 414

V_1 , 77, 81

Vaisala, 419

Victoria station, 324

Vienna Airport, 99, 283

Visual Meteorological Conditions (VMC),
329, 343

Washington Dulles, 10, 123, 262, 322

Westergaard method, 11, 14

Wide Area Augmentation System (WAAS),
390, 395

World War, 2, 3, 215, 314, 396

wreckage, 452

X-ray, 283, 260, 267, 286, **302, 305**

Zaragoza, 9

Zurich, 313, 323