

AD-A278 029

REPORT DOCUMENTATION PAGE			Form Approved OMB No 0704-0188	
<small>Public reporting burden for this collection of information is estimated to average 1 hour per response, including the time for reviewing instructions, searching existing data sources, gathering and maintaining the data needed, reviewing and revising the information, and completing and reviewing the collection of information. Send comments regarding this burden estimate or any other aspect of this collection of information, including suggestions for reducing this burden, to Washington Headquarters Service, Directorate for Information Operations and Reports, 1215 Jefferson Davis Highway, Suite 1204, Arlington, VA 22202-4302, and to the Office of Management and Budget, Paperwork Reduction Project (0704-0188), Washington, DC 20503.</small>				
1. AGENCY USE ONLY (Leave blank)	2. REPORT DATE February 1994	3. REPORT TYPE AND DATES COVERED Final Technical, Jun 93- Feb 94		
4. TITLE AND SUBTITLE DESIGN FOR MANUFACTURING AND ASSEMBLY IN APPAREL: PART I: [REDACTED] HANDBOOK.			5. FUNDING NUMBERS C-DLA900-87-D-0016-0009	
6. AUTHOR(S)  Gioello, Debbie				
7. PERFORMING ORGANIZATION NAME(S) AND ADDRESS(ES) The Educational Foundation for the Fashion Industries 227 West 27th Street New York, NY 10001			8. PERFORMING ORGANIZATION REPORT NUMBER  0009	
9. SPONSORING / MONITORING AGENCY NAME(S) AND ADDRESS(ES) Defense Logistics Agency DLA Manufacturing Engineering BRanch Cameron Station (DLA-PRM) Alexandria, VA 22304-6100			10. SPONSORING / MONITORING AGENCY REPORT NUMBER	
11. SUPPLEMENTARY NOTES  NONE				
12a. DISTRIBUTION / AVAILABILITY STATEMENT  UNRESTRICTED			12b. DISTRIBUTION CODE	
<div style="border: 1px solid black; padding: 5px; display: inline-block;"> <b>DISTRIBUTION STATEMENT A</b>            Approved for public release            Distribution Unlimited         </div>				
13. ABSTRACT (Maximum 200 words)  <u>OBJECTIVE:</u> (U) Achieve commercial publication of a handbook (manual) that will, in a step-by-step procedure, guide garment designers in the development of new apparel styles that will be as efficient and economical to manufacture and assemble as the designer's overall concept will allow.  <u>APPROACH:</u> (U) Make a limited press run of the handbook, distribute copies to educators, etc. for review and comments. Submit also to apparel textbook publishers for inclusion in their lines.  <u>PROGRESS:</u> (U) All activities have been completed. General response to distributed copies has been favorable but publishers have declined to accept the handbook without extensive revision in order to reach widest possible market.  The objectives of this project have not been achieved. The project has been terminated.				
14. SUBJECT TERMS (U)Assembly; (U)Clothing; (U)Computer Programs; (U)Correlation; (U)Efficiency; (U)Feasibility Studies; (U)Handbooks; (U)Manufacturing; (U)Photographs; (U)Production; (U)Skirts; (U)Work.			15. NUMBER OF PAGES	
			16. PRICE CODE	
17. SECURITY CLASSIFICATION OF REPORT Unclassified	18. SECURITY CLASSIFICATION OF THIS PAGE Unclassified	19. SECURITY CLASSIFICATION OF ABSTRACT Unclassified	20. LIMITATION OF ABSTRACT UL	

# DESIGN FOR MANUFACTURING AND ASSEMBLY IN APPAREL

94-11022



Debbie Ann Gioello

Project Leader

Associate Professor: Fashion Design Department  
Advanced Apparel Manufacturing Technology Demonstration  
Educational Foundation For The Fashion Industries  
Fashion Institute of Technology  
DLA 900-87-D-0016-009



DTEC QUALITY INSPECTED 3

94 4 11 149

# DISCLAIMER NOTICE

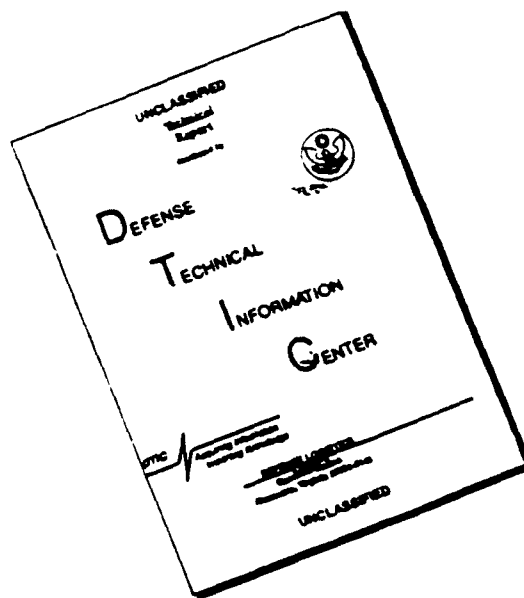

THIS DOCUMENT IS BEST  
QUALITY AVAILABLE. THE COPY  
FURNISHED TO DTIC CONTAINED  
A SIGNIFICANT NUMBER OF  
PAGES WHICH DO NOT  
REPRODUCE LEGIBLY.

# DESIGN FOR MANUFACTURING AND ASSEMBLY IN APPAREL

**Debbie Ann Gioello**

**Project Leader**

**Associate Professor: Fashion Design Department  
Advanced Apparel Manufacturing Technology Demonstration  
Educational Foundation For The Fashion Industries  
Fashion Institute of Technology  
DLA 900-87-D-0016-009**



**DTIC QUALITY INSPECTED 3**

**Copyright© 1991**

**This project has been sponsored by  
Defense Logistics Agency  
Cameron Station  
Alexandria, VA 22304-6100**

**All rights reserved. No part of this book may be reproduced in any form without permission in writing from the publisher, except by a reviewer who wishes to quote passages in connection with a review written for publication in a magazine or newspaper.**

**Library of Congress Catalog Card Number: applied 1991**

# TABLE OF CONTENTS

## CHAPTER

	<b>Preface</b>	<b>iii</b>
	<b>Introduction</b>	<b>v</b>
<b>1</b>	<b>Sample Room - Sample Development Process</b>	<b>i</b>
<b>2</b>	<b>Traditional Plant - Manufacturing Process</b>	<b>15</b>
<b>3</b>	<b>Automated Plant - Advanced Manufacturing Process</b>	<b>49</b>
<b>4</b>	<b>Custom Clothier</b>	<b>93</b>
<b>5</b>	<b>Made-to-Measure</b>	<b>135</b>
<b>6</b>	<b>Design for Manufacturing and Assembly</b>	<b>141</b>
<b>7</b>	<b>Flexible Manufacturing</b>	<b>153</b>
<b>8</b>	<b>Summary</b>	<b>165</b>

<b>Accession For</b>	
NTIS GRA&I	<input checked="" type="checkbox"/>
DTIC TAB	<input type="checkbox"/>
Unannounced	<input type="checkbox"/>
Justification	
By _____	
Distribution/	
Availability Codes	
Dist	Avail and/or Special
A-1	



# PREFACE

**DESIGN FOR MANUFACTURING AND ASSEMBLY (DFMA)** is defined as a methodology used by apparel designers which explicitly considers how the product will be made.

The purpose of the project is to show how to design a garment for ease and efficiency in manufacturing, and to apply the principles of design separately and independently to each of the processes.

The project team designed a tailored skirt incorporating styling that would also be suitable for military use. Recognizing the fact that manufacturing techniques and environments vary, the tailored skirt was designed to take advantage of different manufacturing processes. In order to adapt to the easiest and most efficient assembly procedures, internal details of the garment were changed. However, despite these processes of change and modifications, the integrity of the design and the size range of the garment for each study remained constant.

In preparing the **DESIGN FOR MANUFACTURING AND ASSEMBLY** handbook, all operations performed and necessary in the development of the design, pattern generation and assembling of the skirt were photographed and documented. The assembling procedures were studied and data collected in the Sample Room, Traditional Factory, Automated Plant, Custom Clothier Establishment, and Made-to-Measure environment. Modular Manufacturing Facilities as well as Advanced Technology Environments were visited, and data on these are included in the Flexible Manufacturing chapter.

The project team documented the step-by-step procedures in the development and assembly of the skirt in all the environments, and produced this handbook to illustrate the various processes necessary to design a garment for ease and efficiency in manufacturing. The **DESIGN FOR MANUFACTURING AND ASSEMBLY** handbook is intended to guide the designer to design for facilitation of manufacturing and to maximize the production efficiency inherent in each one of the production processes.

The step-by-step pictorially documented procedures of assembling a garment in different environments required the assistance of many people. Their continued cooperation, generosity and assistance in compiling the data and photographs for the development of the handbook made the task possible.

The project leader wishes to acknowledge the following people, companies and universities for their professional endeavors, use of equipment and facilities, information, and supporting materials and data:

Alfred Arena, F.I.T., Project Investigator;  
 Glenda Pike, F.I.T., Project Investigator;  
 Brett Stern, Symagery Inc., Project Photographer;  
 Nancy Solis, Student Assistant, Project Artist;  
 Cassandra Williams, F.I.T., Computer Consultant;  
 Fredrick Golden, F.I.T., Management Consultant;  
 Aaron Schorr, F.I.T., Manufacturing Consultant;  
 Josef Korngruen, F.I.T., AAMTD, Manager;  
 Tony Ferraro, F.I.T., AAMTD, Technician;  
 Henry Smith, F.I.T., AAMTD, Technician;  
 Marjorie Miller, F.I.T., Proof Reader;  
 Lee Sofia, Hudson Valley Corp., Print Media;  
 George Simonton, George Simonton Inc., Designer;  
 Rosario Panepinto, Bivona Coat & Suit Corp.,  
 Production Facility;  
 Benno Lindenberg, Custom Vetement Assoc.,  
 New York, NY.;  
 Edmond Chouinard, Measurements Research  
 Inc., Providence, RI.;  
 S. Paige Gatlin, Textile/Clothing Technology Corp.  
 [TC]<sup>2</sup>, Raleigh, NC.;  
 James Delapola, Defense Personnel Support  
 Center, Philadelphia, PA.;  
 University of Southwest Louisiana, CIM Labora-  
 tory, Lafayette, LA.;  
 Clemson University, Modular Manufacturing  
 Facility, Clemson, SC.

Special thanks to the following members of the AAMTD facilities: Henry A. Seesselberg, Director of Advanced Manufacturing Technology Program; Noah Brenner, Research Coordinator; Nge Tung Wong, Administrative Assistant; India Rufus, Clerical Assistant.

**Debbie Gioello**  
 Project Leader  
 1991





# INTRODUCTION

Factors related to garment development are design, material, cost, and manufacturing process. All of these factors need to be taken into account at the time of garment conceptualization. The garment should be analyzed as to how well the design lends itself to ease of assembly in the manufacturing process. During the evaluation process, the product development team should explore ways of improving the design to facilitate assembly procedures and, to reduce manufacturing costs.

The designer, besides being a creative person who develops new ideas, needs to have a full understanding of the range of equipment and automation in manufacturing. Designers should address the ease of manufacturing and efficiency of production when developing a garment as the design generates into pattern pieces for making the garment. In order for the garment to be produced efficiently or for the garment section to be aligned properly, the seam contour of the pattern section as well as its shape, length and width need to be considered. This facilitates the efficient use of automated systems.

In addition to styling and production requirements, the designer should also address the performance expectation of the fabric for the style, since machine, equipment and automated functions respond differently to different fabrics.

Knowledge about product end use, production procedures, pricing, and equipment availability prepare the designer to suggest ways to alter or approve a design to take advantage of efficient manufacturing processes. This knowledge would alert the designer with the design constraints before the design task is undertaken. Understanding the constraints and parameters of design and production implementation would reduce the time required for the designing and pattern development process. This time reduction will reduce the trial and error process and costs of sample development. Also, by facilitating the use of advanced technology, the designer helps to assure the competitive position of the company.

If the parameters of the garment designed are such that the garment does not lend itself to the specific manufacturing process intended, then changes are to be made to the design and/or pattern. The changes are to be understood and accepted by the designer as part of the inter-relationships required to achieve ease of assembly and manufacturing.

A prior knowledge of various types of manufacturing processes and of available computerized and automated resources in a plant will enable the designer to create a garment that is efficient to manufacture due to:

- △ The designer's awareness of the problems inherent in the commercialization of designs
- △ The designer's awareness of how to accommodate design to the requirements for production efficiency without sacrificing aesthetics
- △ The designer's ability to identify the most appropriate manufacturing technologies for producing a particular garment

In the analysis of the assembly process itself, the goal is to design and incorporate assembly procedures that help assure a better quality garment, reduce the cost of manufacturing, and provide better service to customers.

All too often the designer works within the design constraints while the programmer of computers and automated equipment works isolated from the concept of the designer. The programmer may often miss a simple, direct solution to an objective, and the designer becomes discouraged because the design will not work in the environment selected. If the process of design for ease and efficiency of manufacturing using automated and advanced technologies is to be considered, then the designer must know the functions and the parameters of each of the manufacturing processes.

A software package can be implemented that permits designers and the product development team to analyze and evaluate the garment design, assembly procedures, manufacturing implementation and cost effectiveness. A software program with a rule base for design development under different manufacturing constraints would allow for:

- △ Designs which meet requirements
- △ Adoption of new designs as they relate to similar designs
- △ Recording information about the design which could be applied to future designs
- △ Shorter design time
- △ Greater productivity
- △ Establishing cost estimating methods
- △ Comparison of cost differences under alternate assembly processes
- △ Economical production

The DESIGN FOR MANUFACTURING AND ASSEMBLY handbook addresses the designer's role in creating a garment for ease of manufacturing and assembling. Assembling procedures and manufacturing methods for a tailored skirt in different production environments are employed. These examples show the changes that are made to best utilize and maximize the production capabilities of each of the manufacturing processes.

The designer's concepts were integrated in the planning stages of production implementation. Likewise, the production personnel, especially those employing automated technologies at their facilities, were aware of how the designer wanted the tailored skirt interpreted for ease and efficiency in manufacturing. It was evident that changes in the original pattern were necessary to better utilize fabric, processes, equipment, and technology.

In order to utilize specialized equipment and advanced technologies, the skirt design was modified by changing and/or eliminating specific construction details such as pocket size, shape and placement, as well as seam size and shape. Finishes of seams and hem edges were changed to permit use of efficient production procedures and available equipment.

Custom and Made-to-Measure procedures were studied and documented to illustrate pattern generation, fitting, manufacturing, and assembling accommodations for individuals that do not conform to standard size ranges or who otherwise seek a more personal fit.

To illustrate how to design a garment for ease and efficiency of assembling and manufacturing, the designer of the tailored skirt used in this study applied technical knowledge as well as creative ability.

The designer and project leader, as well as other members of the project team, were familiar with machinery, equipment, engineering functions and operations in Traditional plants, Automated Manufacturing plants, Custom Clothier establishments and Made-to-Measure facilities.

To take advantage of new technologies, which include computer aided design (CAD) and computer integrated manufacturing (CIM), changes in the original pattern were incorporated without altering the aesthetics of the design.

These changes, are discussed and illustrated in detail in Chapter 6. They include:

- △ Width of seam allowance
- △ Shape of seams designed with pleats
- △ Type of pleat
- △ Location of pocket
- △ Style of pocket
- △ Location of coin pocket
- △ Styling of coin pocket

Changes due to the operational differences of various plant facilities, are illustrated in Chapters 1 through 5. These changes include:

- △ Assembling procedures
- △ Sequence of operations
- △ Utilization of machinery and equipment

Other factors to be considered in pattern development are:

- △ Fabric efficiency
- △ Ease of marker making
- △ Reduction of manufacturing costs

From the inception of the design in the sample room through all the various processes, which included the Traditional Plant, Automated Plant, Custom Environment and Made-to-Measure facility, the handbook illustrates operations, tools, equipment and computer assisted programs in manufacturing. Chapter 7 covers Flexible Manufacturing applications.

The handbook is intended for:

- △ Understanding the design process
- △ Awareness of sample garment development
- △ Recognizing assembling procedures in a traditional plant
- △ Recognizing assembling procedures in a plant using automated equipment
- △ Methodology analysis used in different plant environments
- △ Operational studies of manufacturing sequence
- △ Flexible manufacturing implementation studies
- △ Establishing a database of assembling procedures
- △ Simulation study guidelines
- △ Understanding the need to modify existing patterns for ease of assembly in manufacturing

# CHAPTER 1

## SAMPLE ROOM SAMPLE DEVELOPMENT PROCESS

A sample garment is the initial development of a prototype to test style, size, fit, feasibility of design and production. This original sample garment may be developed in a commercial design studio specializing in product development, in the sample room of a production facility or in the studio of a custom tailor.

Sample room personnel are professionals skilled in one or more steps in the developmental process from design conception to garment completion. The individual garment is assembled by one person from the original single ply cutting through all the stages of assembling, fitting, and finishing.

Changes in garment details are made during sample development. Procedures for assembling are discussed among the designer, designer assistant, sample maker and production personnel. Efficiency of operation as well as ease of manufacturing, available equipment and costing are considered when finalizing the style, selecting the fabric and developing the pattern. The final design is approved at a product line adoption meeting led by the designer and merchandise manager.

During the development of the tailored skirt sample used throughout the book, the top stitching design detail shown in the original sketch was eliminated allowing for ease of manufacturing and cost effectiveness. The external appearance of the skirt remained unchanged; however, internal details such as pocket type and placement, and seam size and shape, were considered for ease of assembly.

The designer's knowledge of plant facilities and equipment and understanding of the extent of automation in the manufacturing process allowed the designer to design the garment and generate patterns to maximize production efficiency.

Following is a list of equipment and tools that may be found in a sample room and a sequence of operations for assembling the tailored skirt. This chapter on sample room procedures illustrates the sequence of operations from design inception to completed samples as observed in the design room of George Simonton, a New York City based company.

**EQUIPMENT AND TOOLS THAT MAY BE FOUND IN A SAMPLE ROOM:****Machines**

lockstitch sewing machine  
 overedge/serging machine  
 buttonhole machine

**Pressing equipment**

gravity fed steam iron  
 pressing board  
 buck press  
 clapper  
 ham  
 seam roll

**SEQUENCE OF PROCESSES IN THE SAMPLE GARMENT DEVELOPMENT:**

Collection designed by designer  
 Fabric selected  
 Trimmings and findings selected  
 Pattern developed following sketch  
 Pattern fitted on model form  
 Discussion with sample makers and production liaison  
 Pattern corrected and trued  
 Garment cut from sample fabric using original patterns  
 Sample garment review with cutter and costing personnel  
 Garment assembled  
 Assembly procedure discussion with sample maker  
 Assembled pieces are underpressed  
 Garment fitted at various stages of completion  
 Sample garment corrected and/or revised  
 Final garment pressed  
 Hard copy of patterns developed  
 Specifications developed  
 Parts list and bill of materials prepared ("Cutters Must")  
 Production procedures discussed with production personnel  
 Garment sent for duplication  
 Sample garment shown in showroom

**NOTE:** This list shows steps in developing samples for the product line from concept to showroom samples.



Designer, George Simonton, designing skirt used for project.



Collection of designs from the George Simonton collection.

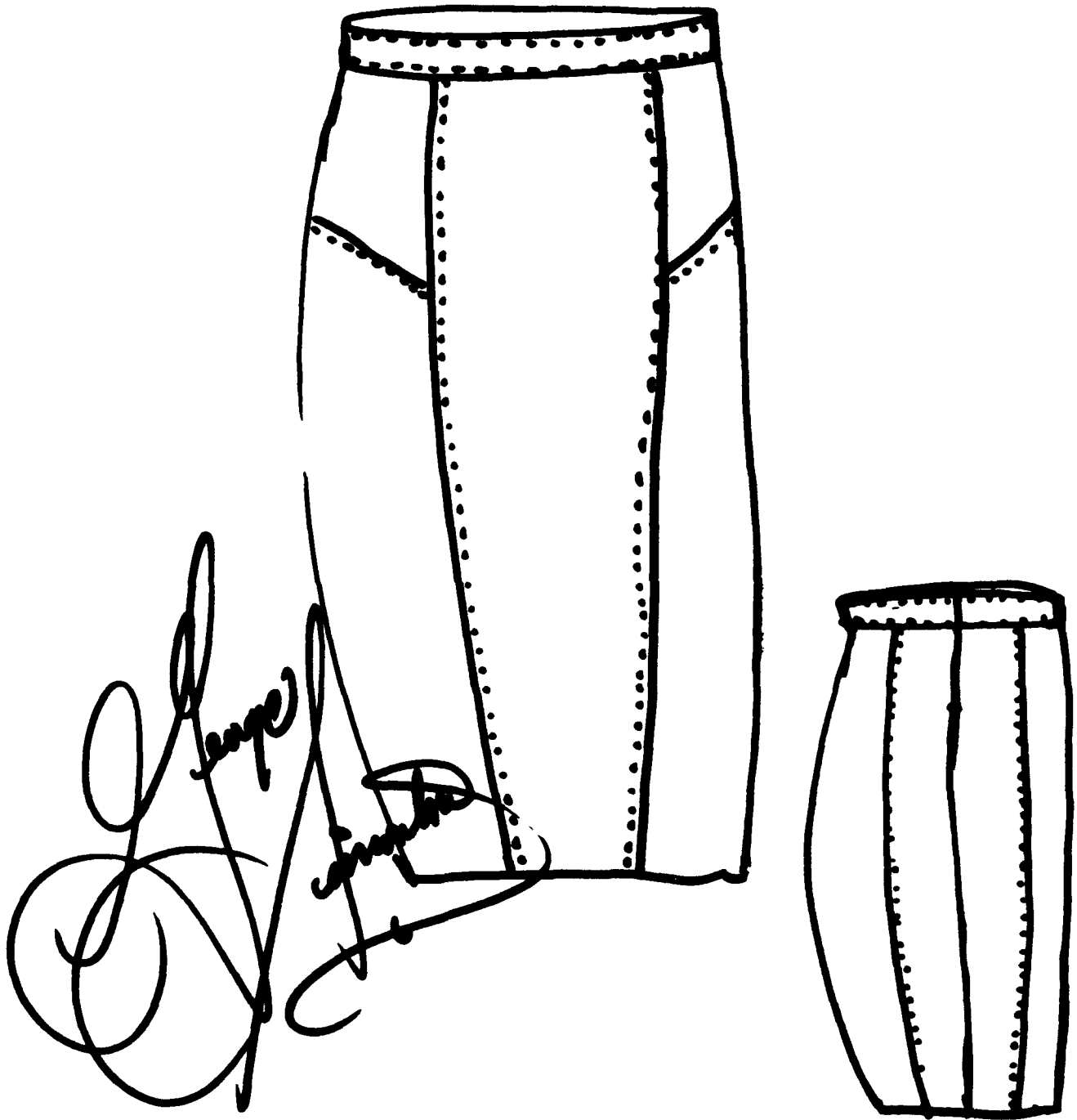

Finished sketch.



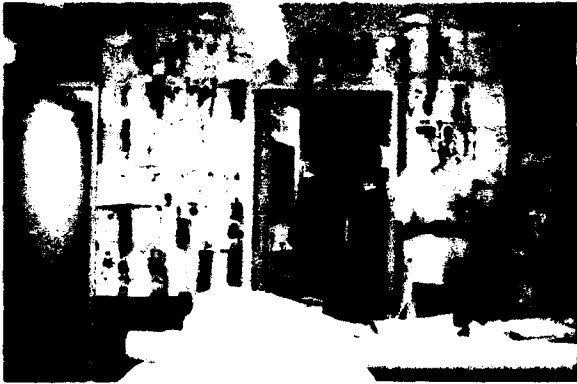

George Simonton's sample room. Scene of work in progress.



Muslin samples and samples of work in progress on rack. Sample room scene.

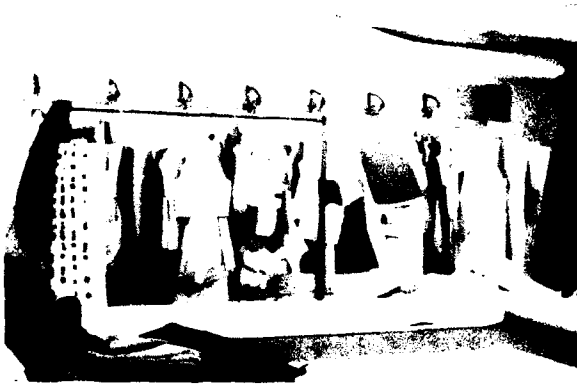

Oaktag patterns of styles in progress.

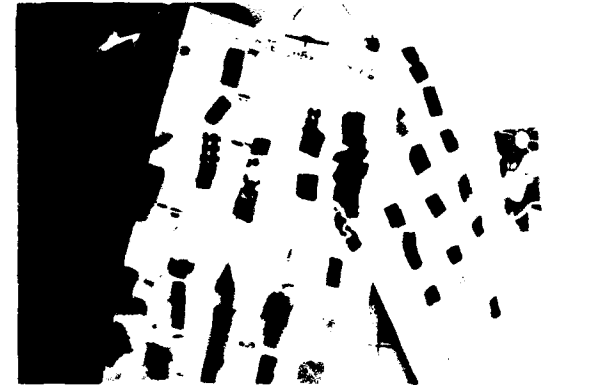

Duplicate fabric swatches and color chart of work in progress.



Samples of fabric to be used in the collection.

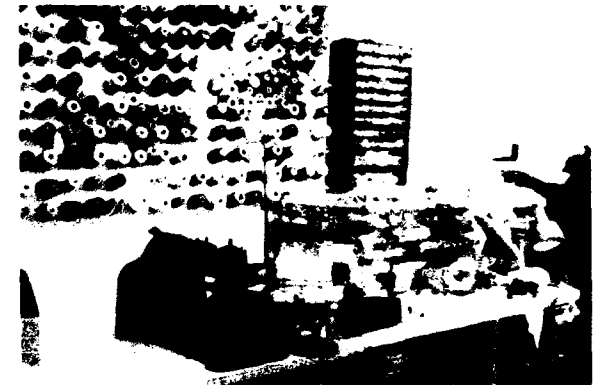

Threads, buttons and findings to be used for the collection.

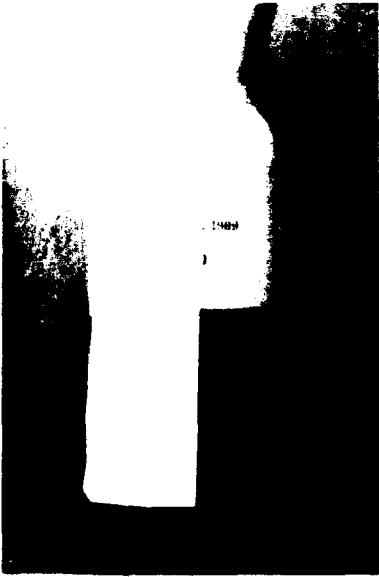

Skirt pattern draped in muslin. Front view.



Side view.



Back view.



Assistant designer makes paper pattern and hard copy from muslin sample pieces.



Clearing the table in preparation for layout and cutting of fabric for the sample.



Process of cutting out sample skirt.



Assistant designer checks over cutting procedures and fabric utilization with sample room cutter. A key consideration in cost and manufacturing efficiencies



Assistant designer checks pattern and discusses production procedures with production person.



Pattern maker and production personnel discuss hardcopy pattern pieces, style details, fabric and findings and production sequence and methods.



Hard copies of pattern pieces for styles in progress. Styles from the overall collection awaiting adoption.



Sample maker/tailor assembles sample skirt.

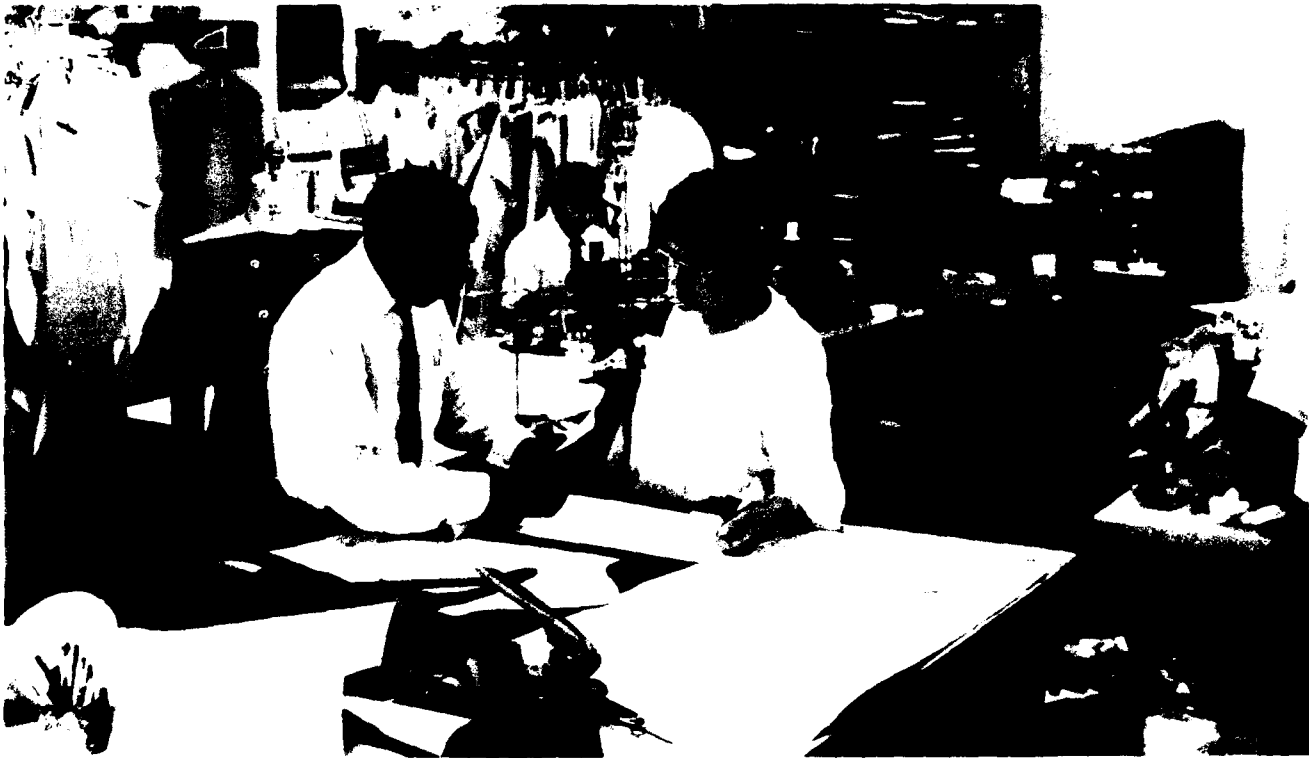

Pattern maker discusses assembly procedures with sample maker. Top stitching detail shown on original drawing is eliminated.

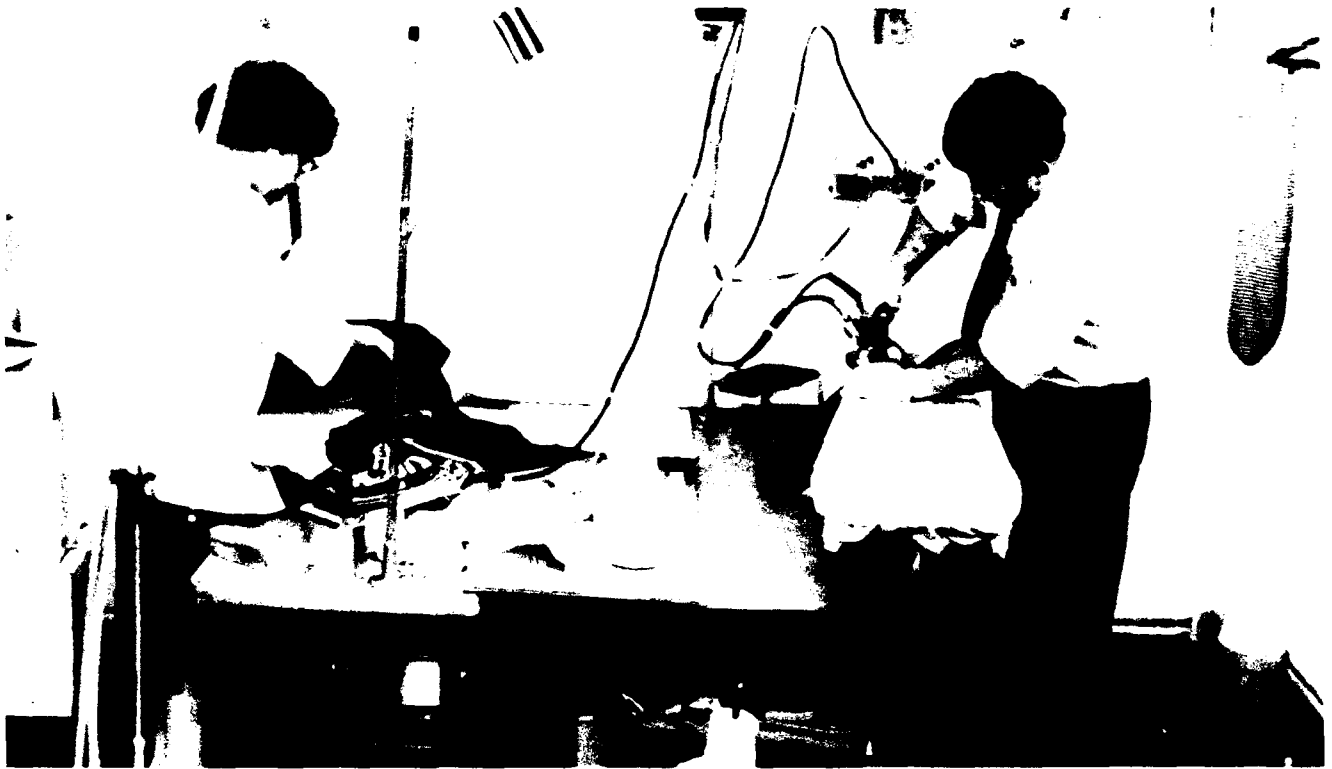

Sample makers underpress assembled sections as skirt progresses.



Final pressing of sample skirt.



Designer examines fit of sample skirt on dress form.



Sample skirt completed.

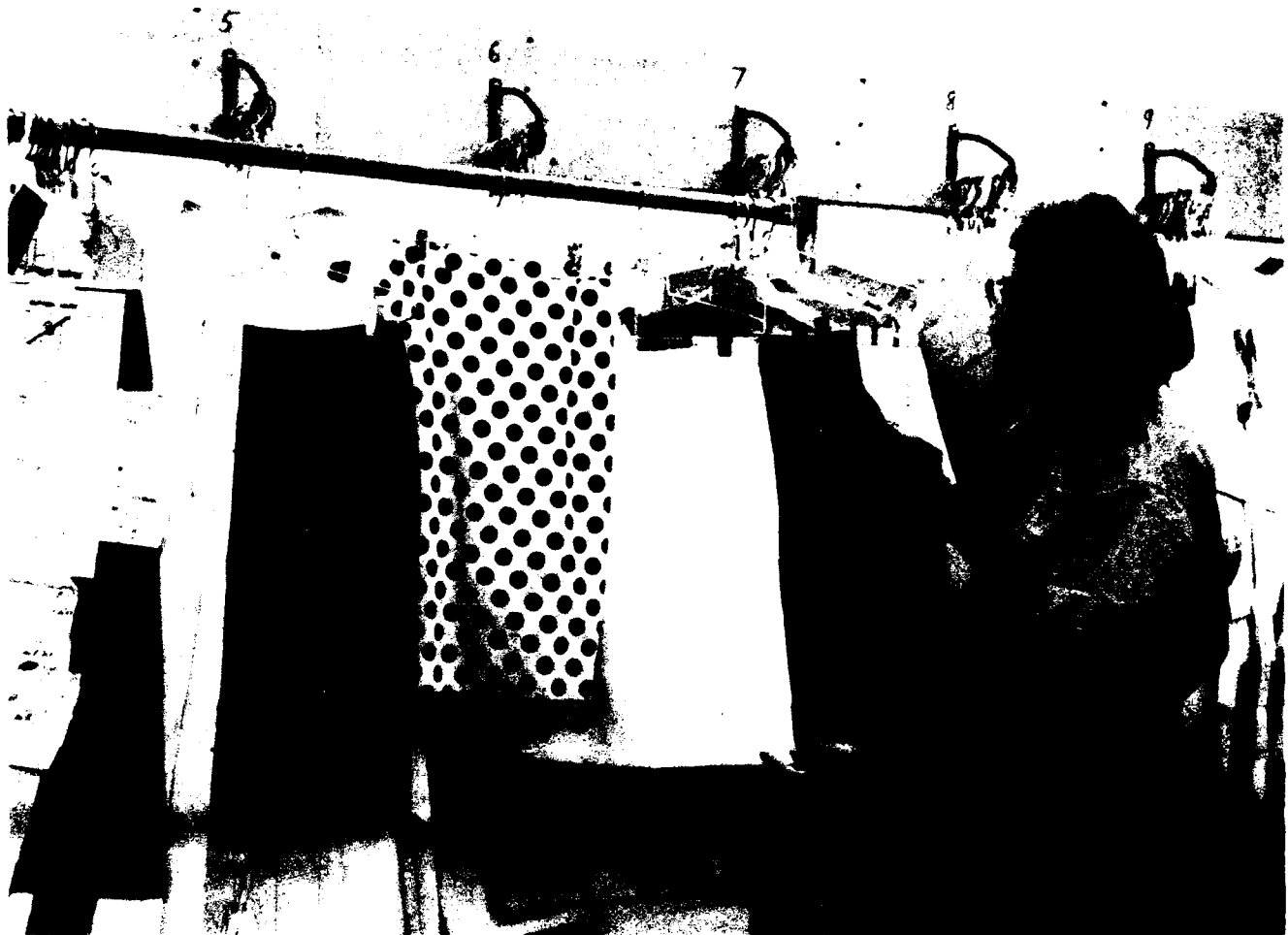

Sample skirt and other skirts of collection in sample room.

**PATTERN PIECES OF TAILORED SKIRT**

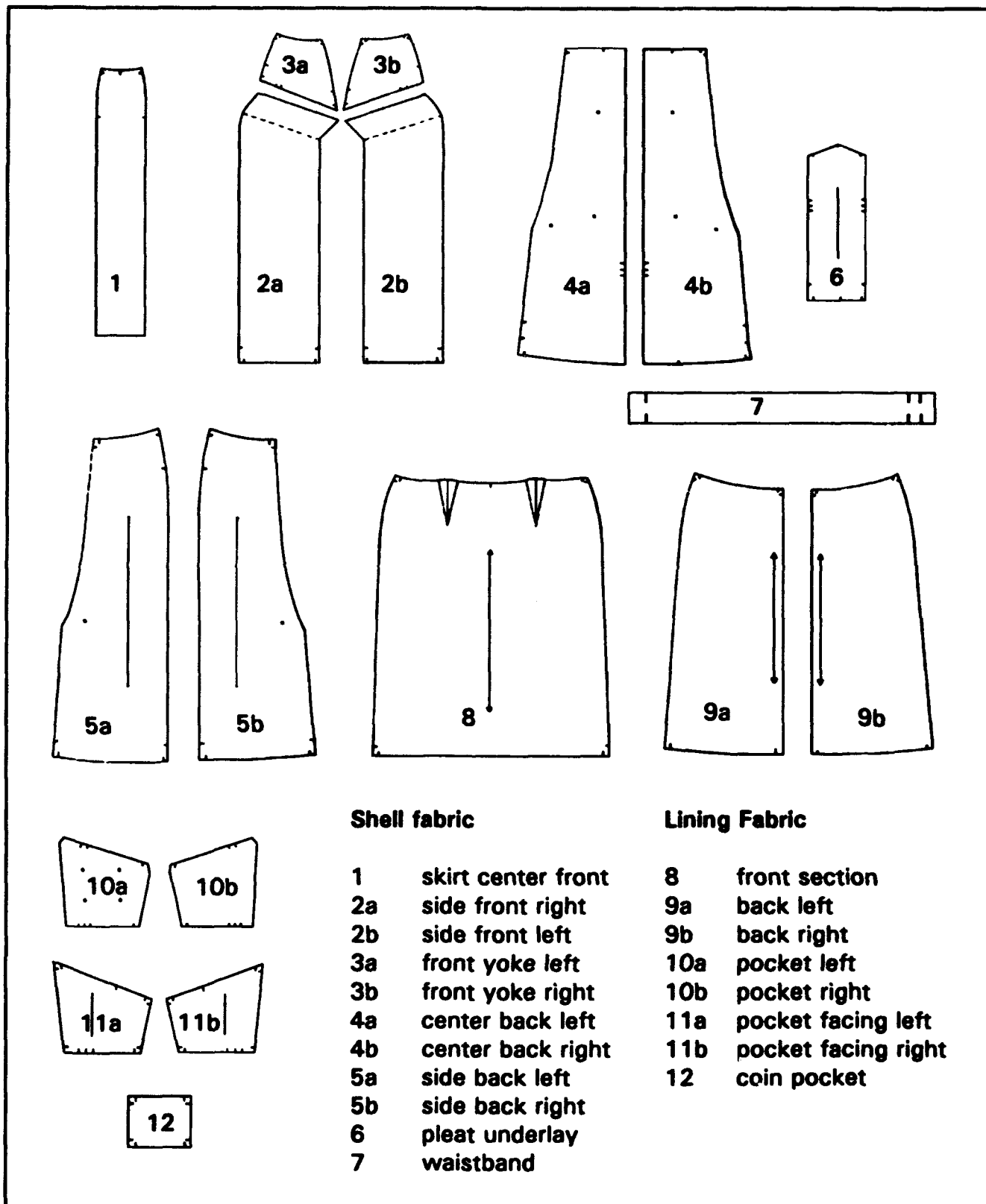

**Shell fabric**

**Lining Fabric**

- 1 skirt center front
- 2a side front right
- 2b side front left
- 3a front yoke left
- 3b front yoke right
- 4a center back left
- 4b center back right
- 5a side back left
- 5b side back right
- 6 pleat underlay
- 7 waistband

- 8 front section
- 9a back left
- 9b back right
- 10a pocket left
- 10b pocket right
- 11a pocket facing left
- 11b pocket facing right
- 12 coin pocket



Pattern maker checks patterns for "spec" measurements.

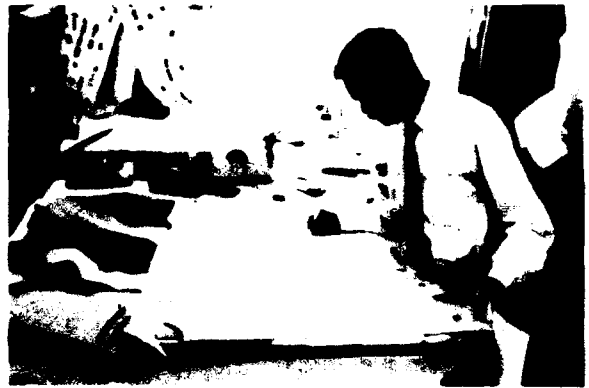

Pattern pieces and related pattern information are recorded.



Pattern maker prepares a "Cutters Must" for duplicate maker and for marker-making.



<b>CUTTERS MUST</b>			
Compare this Ticket with Materials, Patterns, and Cutting Ticket			
<b>Style</b> DLA 009			
<b>Sample of</b> Women's skirt (tan)			
PATTERNS		YARDAGES	
<b>For Shell Fabric</b>			
<b>PIECE #</b>		<b>CUT</b>	
1	Center Front	1	Shell fabric
2	Side Front	2	Lining Fabric
3	Side Front Yoke	2	Fusible interfacing fabric
4	Center back	2	Waistband interfacing (on roll)
5	Side Back	2	(1 7/8" slotted center and seams)
6	Pleat Underlay	1	Waist elastic 7/8" (on roll)
7	Waistband	1	
		<b>REMARKS</b>	
<b>For Lining Fabric</b>		<b>MARKERS FOR:</b>	
8	Front	1	Skirt Shell Fabric #
9	Back	2	Skirt Linings Fabric #
10	Inside Pocket	2	Pocket Interfacing Fabric #
11	Pocket Facing	2	
12	Coin Pocket	1	
		<b>TEMPLATE</b>	
		Waist elastic 7/8" X 4 1/2"	
		Pleat marker	
<b>For Interfacing Fabric</b>			
13	Pocket flap	2	
	Waistband (on roll)	1	
		<b>TRIMMINGS</b>	
		7" zipper	
		hook & bar closure	
		hanger hooks 10"long	
		seam binding/seam tape (on roll)	
		7/8" elastic (on roll)	

"Cutters Must" contains information regarding: Pattern piece identification; all fabrics used for garment; findings and trimmings needed; and other information needed to cut garment.



Designer George Simonton showing his collection to buyers in his New York showroom.

## CHAPTER 2

# TRADITIONAL PLANT MANUFACTURING PROCESS

The mass production operations performed in the "Traditional Plant" environment utilize precision equipment and mass production construction techniques. The manufacturing processes are coordinated to produce quality garments efficiently and economically. The machines and processes are geared to perform many of the quality hand tailoring operations faster, better and with more consistent quality.

Mass production environments may include advanced technology equipment and operations which utilize computer aided design (CAD), computer integrated manufacturing (CAM), programmable sewing machines, and programmable pressing equipment. Unit Production Systems (UPS) may be installed to replace all or part of the traditional bundle systems.

Modular manufacturing systems (MMS) may be planned for all or part of the manufacturing procedure in mass production environments.

Changes to the skirt were recognized for ease of manufacturing in a traditional plant. These changes offered as alternatives from the original concept of the design and pattern are specifically illustrated in Chapter 6.

The two-inch seam allowance originally designed for the center back of the garment was reduced to a conventional size in order to obtain better fabric yield in marker making, to eliminate drill holes used to guide placement of superimposed parts, and to reduce sewing errors in production.

The side back section seam width and shape was reduced to a conventional size and to even widths. The change eliminates margin of error in alignment of seams and covering of drill holes.

The coin pocket was applied as a patch pocket on the pocket lining instead of within the seam of the yoke as shown in Chapter 4, Custom Clothier Manufacturing. The method of application is easier, requiring less skill and is faster to produce.

Lining seams were finished using a pinking machine. The seams could also be finished using a serger or safety stitch.

The lining hem could be finished using a hemming attachment instead of turning the hem edge manually.

Instead of overedging/serging the free edge of the waistband, folder and binder attachments may be used to apply bias binding as an edge finish.

For assembling procedures, garment sections and specific operations are completed by different operators. Several operations are performed sequentially to take advantage of plant layout, special attachments, specific equipment and skill of operator.

Following is a list of equipment, machinery and tools that may be found in the Traditional Plant.

#### EQUIPMENT AND TOOLS THAT MAY BE FOUND IN A TRADITIONAL PLANT:

##### Equipment

CAD/CAM system  
cloth inspection machine  
spreader  
cutting machines  
drill  
ticketing machine  
Unit Production System  
point turner

##### Machines

lockstitch sewing machine  
overedge/serging machine  
chain stitch machine  
pinking machine  
blindstitch machine  
button hole machine  
button sew machine

##### Pressing equipment

steam irons  
pressing boards  
buck press  
fusing press

##### Attachments

folders  
binders  
guides

#### SEQUENCE OF OPERATIONS IN A TRADITIONAL PLANT:

##### I GENERATING CUT WORK:

###### Inspection of fabric

detection of defects or flaws  
measurement of extent of defect  
classification of defect  
marking defect  
length and width

###### Spreading of fabric

face up, nap one way  
face up, nap two way  
face to face, nap two way  
face to face, nap all pairs one way  
face to face, nap within pair one way

**NOTE:** Choice of spreading method depends on fabric and style of garment. Shape, size and number of pattern pieces affect utilization of fabric.

**Cutting of fabric**  
 vertical knife  
 band knife  
 circular knife  
 die cutting  
 notching and drill holes

**NOTE:** Choice of cutting method and/or cutting knife used depends on fabric type, pattern shape, size of pattern part and/or ply count of layout.

**Bundling**

**Ticketing**

Choice of stapled or press-on type  
 Choice of hand or machine application

**II ASSEMBLY: Operations on parts that may be performed individually and brought together for final assembly.**

(A)	(B)	(C)	(D)
Skirt front	Skirt back	Waistband	Lining
Overedge sections Hem coin pocket Attach/Assemble: Coin pocket to pocket lining Lining to yoke Underpress Interfacing to pocket edge Pocket lining to pocket edge Lining to yoke Underpress Lower edge to yoke panel Tack pocket Underpress Side panel to center front panel Press	Overedge sections Sew center back seam Insert pleat underlay Underpress Insert zipper Join side panels Underpress Mark pleats Top stitch pleats Press	Apply interfacing to waistband Finish one edge of waistband* Press Attach elastic**	Sew darts Join center back Join side seam Finish seam edges Hem slit Hem lower edge Press

**NOTE:** \*Free edge of waistband may be overedged/serged or finished with bias binding.  
 \*\*Elastic may be applied after waistband is attached to skirt waist.

**III FINAL ASSEMBLY:**



Join front & back at side seam  
Press  
Attach lining at zipper opening  
Attach lining at waistline  
Apply waistband  
Insert hanger strips  
Close corners of waistband  
Turn corner  
"Crack stitch" waistband

**IV FINISHING:**



Apply closure at waist  
Attach seam tape to hem  
Hem with blindstitch machine  
Clip and stitch inside pleat seam  
Final pressing

**V FINAL PRESSING:**

**NOTE:** Under pressing and piece pressing may be done with steam irons or pressing machines.

Fabric Swatch						
Shell sample						
YARDS		76.10 YDS				
COMPANY				PIECE #		
				1882		
STYLE	PAT.	FIN	COLOR	PM	PUT-UP	WIDTH
724-668	724	0491	668			61.5
BATCH	COLOR DESCRIPTION		FABRIC FIBERS			
5305	BEIGE		100% AUSTRALIAN MERINO WORSTED WOOL			
GREIGE PIECE		GABARDINE 2X2				
061-088955						
			PRODUCER I.D.			
			015600			
						
<b>042532838</b>						

**SHELL FABRIC TAG:**  
Identification tag attached to each roll of shell fabric.

Fabric Swatch						
Lining sample						
YARDS		82.10 YDS				
COMPANY				PIECE #		
				1882		
STYLE	PAT.	FIN	COLOR	PM	PUT-UP	WIDTH
675-552	675	0543	552			51.3
BATCH	COLOR DESCRIPTION		FABRIC FIBERS			
5201	CREAM		100% ACETATE			
GREIGE PIECE		WOVEN 180				
034-055677						
			PRODUCER I.D.			
			019611			
						
<b>042838893</b>						

**LINING FABRIC TAG:**  
Identification tag attached to each roll of lining fabric.

			SPG BY
			DEC BY
			ROLL BY
MILL			
Mill Style	Piece No.	1882	
Yards before Shrinking	76"		
Width before Shrinking	61.5		
Yards after Shrinking	70"		
Width after Shrinking	60.5		
Company:			

**FINISHING PROCESS TAG:**  
Identification tag attached to each roll of fabric, showing shrinking process.

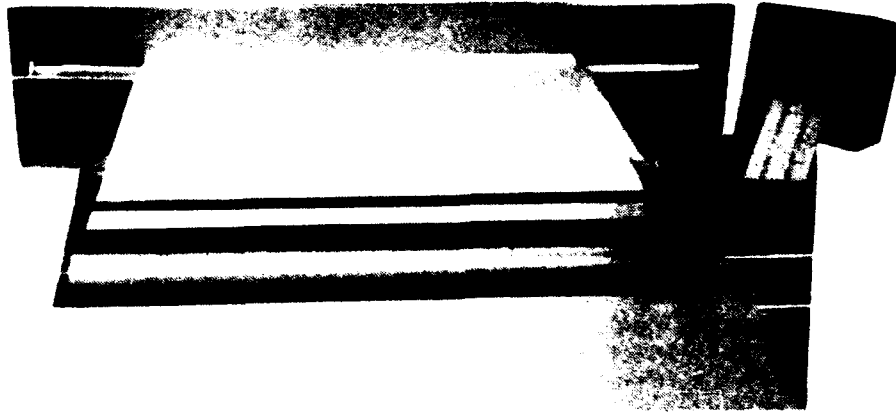

Fabric is inspected prior to spreading. Cloth inspection machine locates flaws, recognizes color differences, and determines width variations for fabrics.

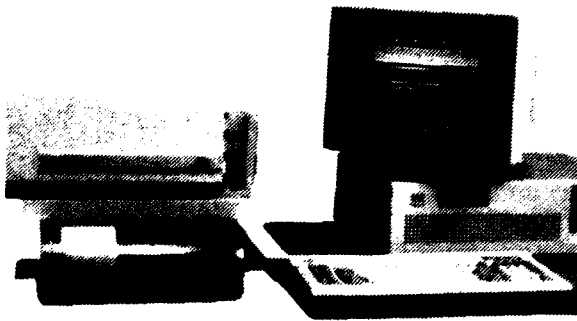

A computerized control system which monitors product quality of high speed web and film materials and which can control cutting machines or other flaw marking or flaw management equipment.

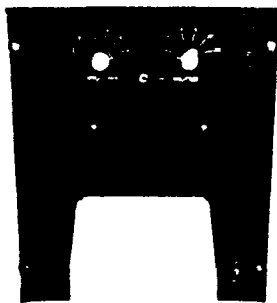

Product Quality Signatures are printed out on an inkless 4-channel recording, corresponding to the 4-quarter sections across the width of web.

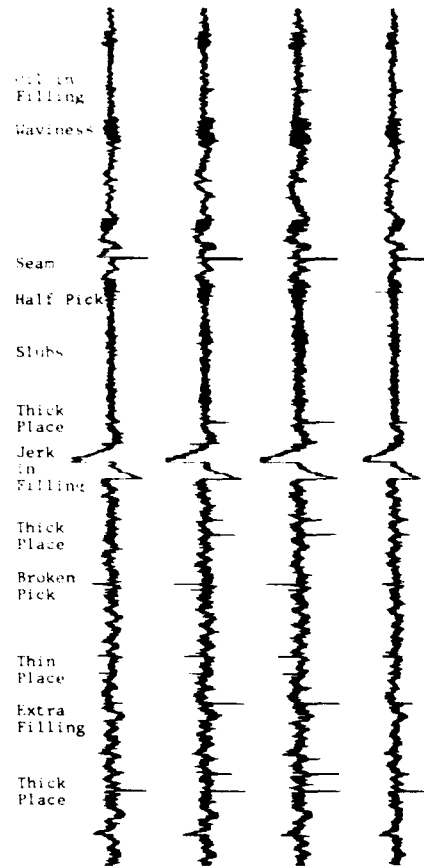

The four Signature Traces indicate the magnitude of irregular events, many of which will be called unacceptable flaw events as determined by quality control personnel.

Photographs and information courtesy of: Measurements Research Inc., Providence, R.I.



Style # 009	<h1>CUTTING TICKET</h1>	Date _____
Marker Length 1 yd per sample size		Lot # _____
Size Proportion		Cutter _____
10 (Sample Size)		Contractor _____
24		<b>TRIMMINGS</b>

Shade	Color	Yd.	Pc. #	Total	Trimming
1					<b>Zippers</b>
2					<b>Buttons</b>
3					<b>Hangers</b>
4					<b>Belt</b>
5					<b>Size Ticket</b>
6					<b>Misc.</b>
7					<b>Ribbon</b>
8					<b>Piping</b>
9					<b>Laces</b>
10					<b>Embr.</b>
11					<b>Pleating</b>
12					<b>Misc.</b>
13					<b>REMARKS</b>  Sample size only to be cut for duplicates and for road samples.
14					
15					
16					
17					
18					
19					
20					
21					
22					
23					
24					
25					
26					
27					

"Cutting Ticket" is used: to cut duplicates from sample size; for production cutting and to prepare for marker-making. Cutting ticket and quantities on the ticket are based upon expected sales ratio or on active sales generated.

DESIGN FOR MANUFACTURING AND ASSEMBLY IN APPAREL

Markers may be made by hand and then duplicated or generated by computer and stored.

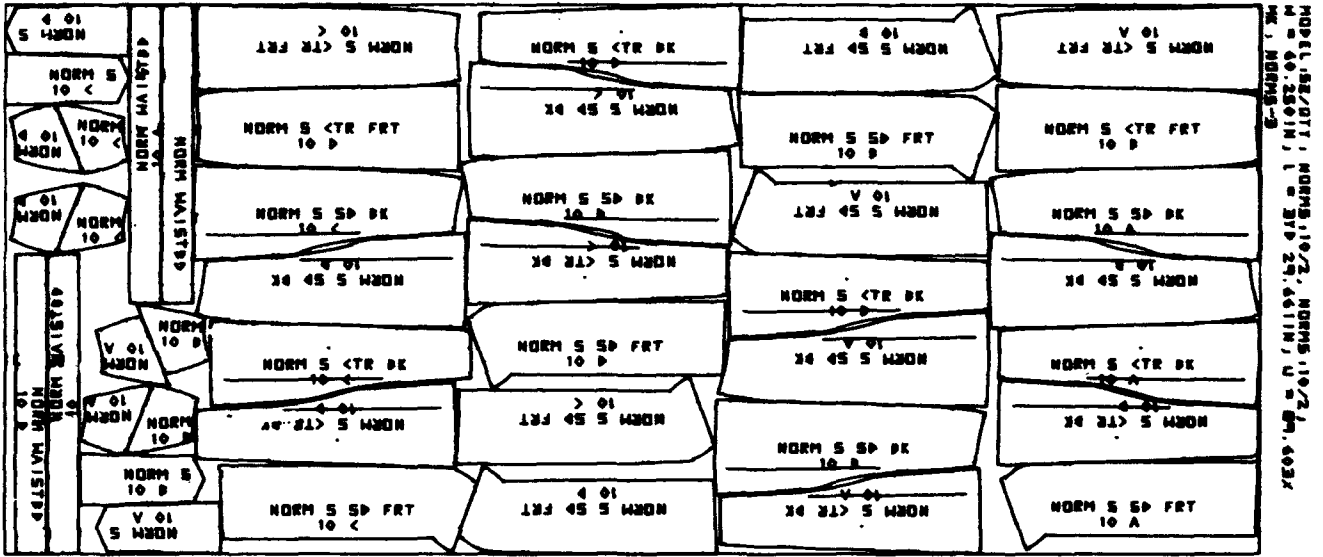

Marker for skirt shell fabric.

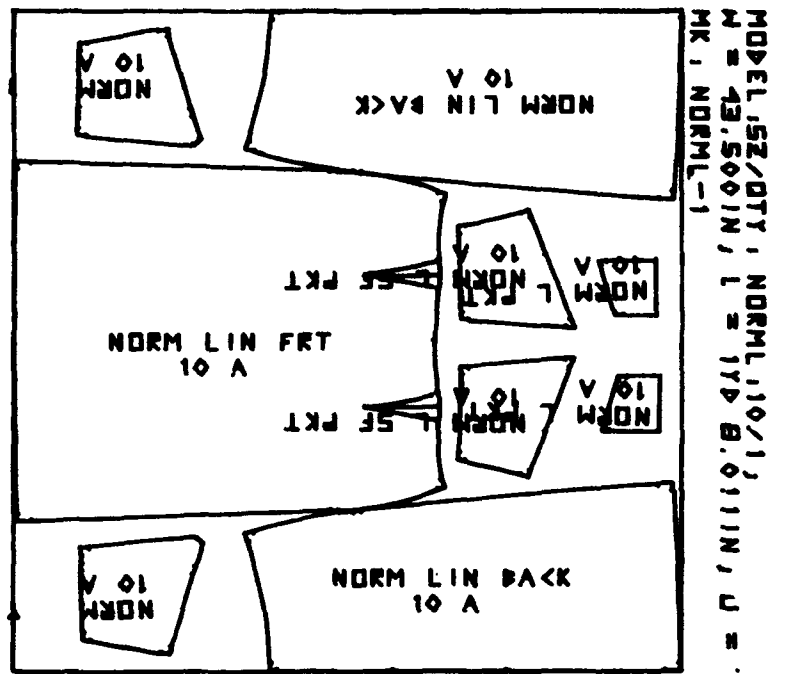

Marker for skirt lining fabric.

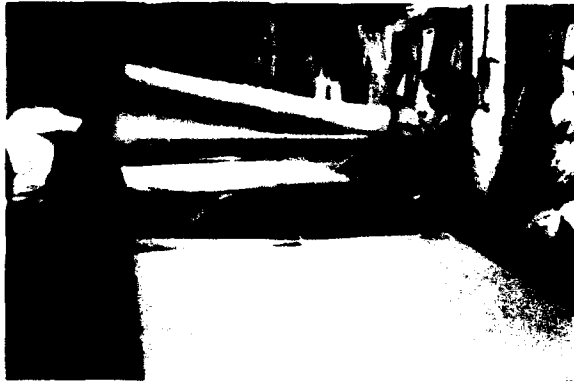

Spreader prepares underlay kraft paper to conform to the length of the marker.

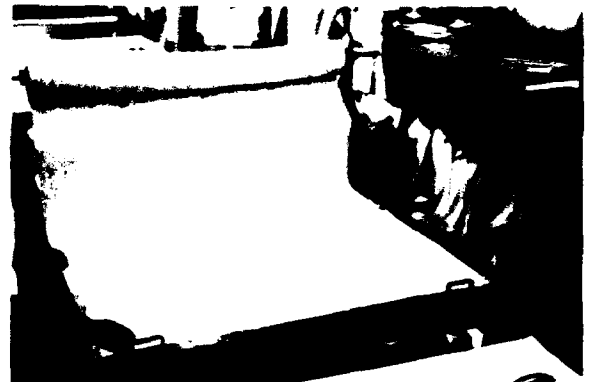

Fabric is spread starting at end of kraft paper.

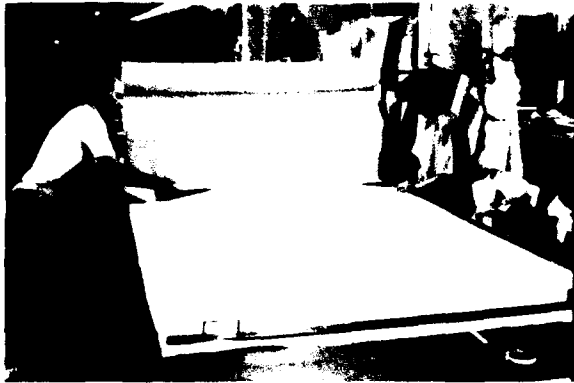

Fabric is spread to end of kraft paper underlay and length is cut.



Next fabric ply is spread in a one direction lay.



Treated paper is placed over fabric ply.

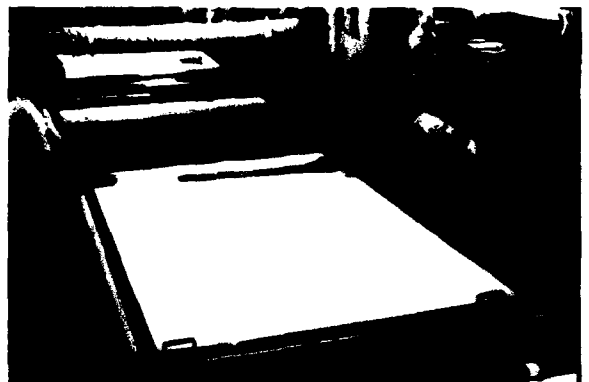

Marker is placed over all plies and held in place with weights.



Marker is stapled through treated paper and fabric plies to avoid shifting.



Cutter, using the straight blade cutting machine, cuts out pattern piece.



As pieces are cut away from marker, final cutting proceeds.



Round blade cutting machine is used to cut out lining.



Pieces cut with the round blade are checked for notches.



In this example, notches are made with shears. In production, a notching device is used



Cut pattern sections are readied to be ticketed.



Pieces are separated by color and shade and bundled.

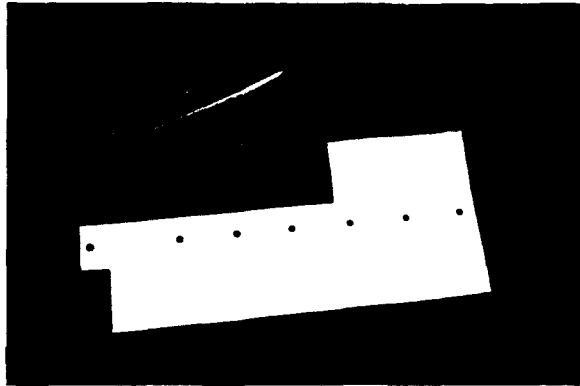

Ticket marked with bundle information will be attached to bundle.

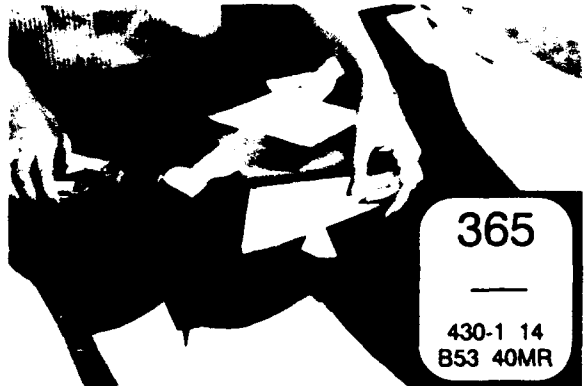

Shade & piece identification ticket may be stapled to individual pieces by hand.

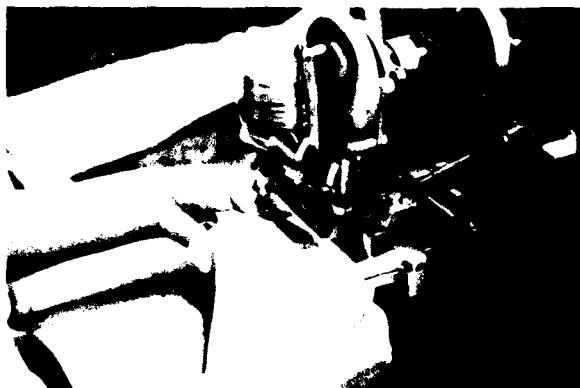

Identification tickets may be applied using an automatic ticketing machine.



Identification ticket applied to each piece.



Fusible interfacing is cut for waistband section and for pocket of skirt.

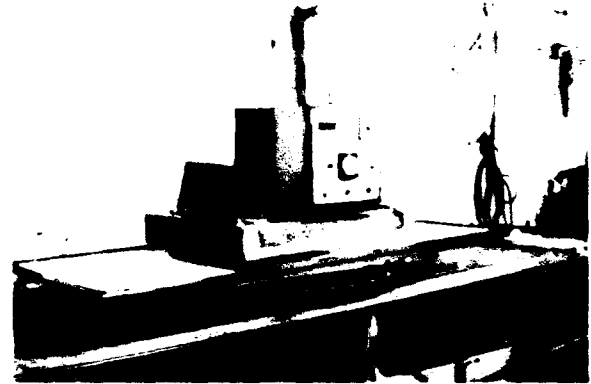

Automatic fusing machine will be used to fuse interfacing to waistband.

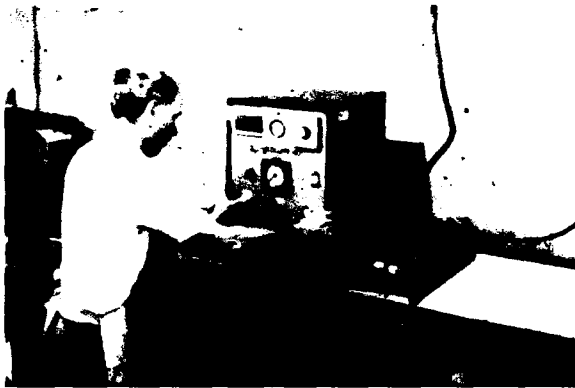

Fusing machine is programmed for heat, pressure and contact time.



Bundles of work are brought to supervisor of plant for distribution.



Assembling procedures and section work allocation are discussed with plant manager and floor supervisor.



Fusible interfacing is readied for application to skirt pocket section.



On the plant floor various assembly operations may be carried out simultaneously.



Floor manager carries bundles of work to different locations for various assembling procedures.



Sections for various aspects of assembling operations.



Inspection and cleaning areas.



Pressing area for underpressing sections of work as needed.



Sections of the skirt shell fabric are overedged/serged.

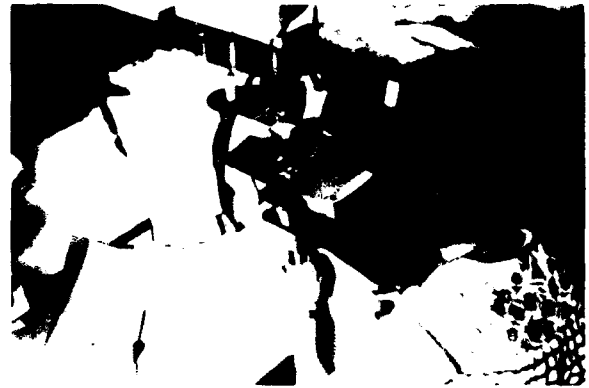

Pieces are overedged on three sides. Hem edge is not overedged.

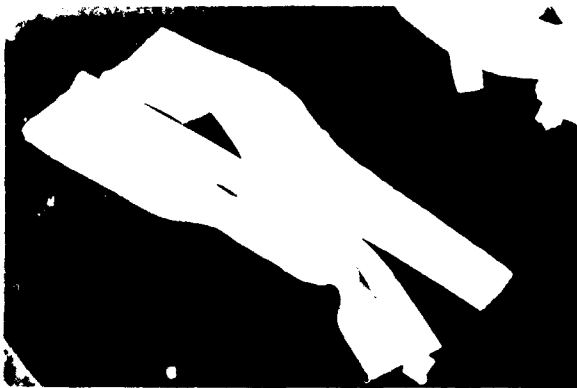

Center back seam sections are stitched between notches allowing openings for kick pleat application and zipper.



Lower edge of center back section prepared for kick pleat underlay application.



Stitching kick pleat underlay in place.



Stitching opposite seam of kick pleat underlay.





Kick pleat assembly completed.



Stitching lower edge of pleat temporarily to aid in pressing sequence.



Face of kick pleat showing temporary stitch and pleat folds.

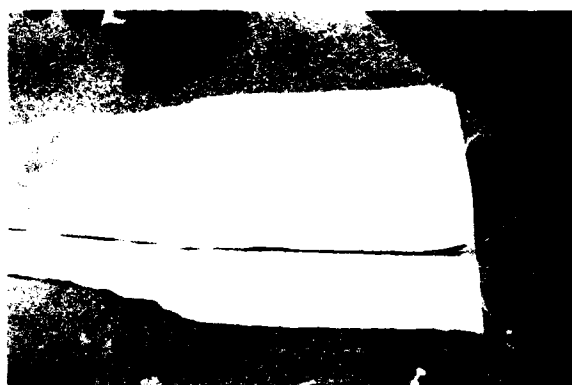

Inside view of center back with kick pleat completed.



Press kick pleat in place.



Attach side back section to center back section.

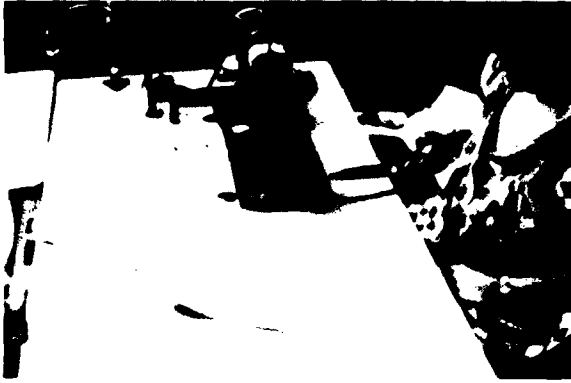

Side back section assembly operation completed.



The side pleat sections are stitched temporarily for the pressing sequence.



Side pleats and seams are pressed.



Pressed back skirt section.

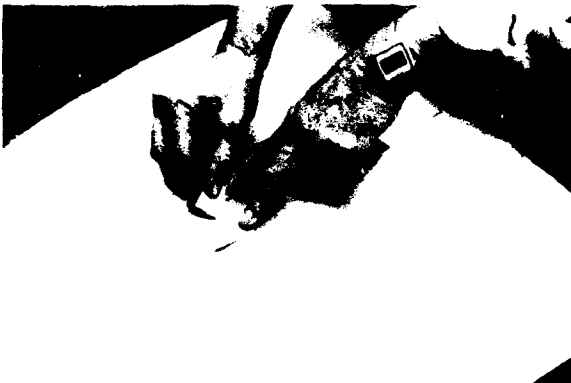

Using a template, chalk a guide line for stitching underlay of pleats.



Underlay of kick pleat and two side pleats stitched. Stitch shows on face of garment.

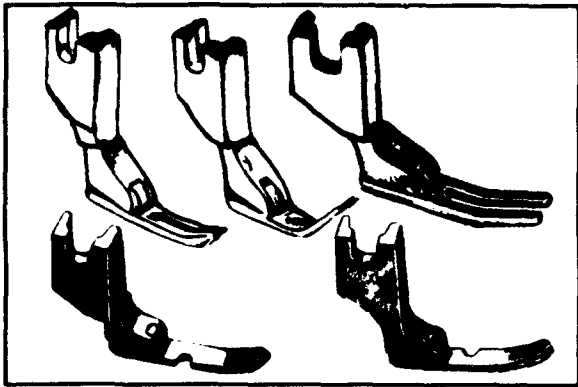

Zipper foot attachment for lap zipper or slot zipper application.



Zipper applied to left section for lap zipper application.

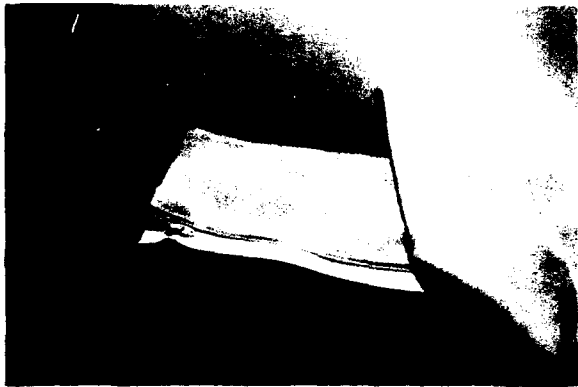

Left section of zipper application completed.



Lap section stitched to conceal zipper.



Inside view of lap zipper application.

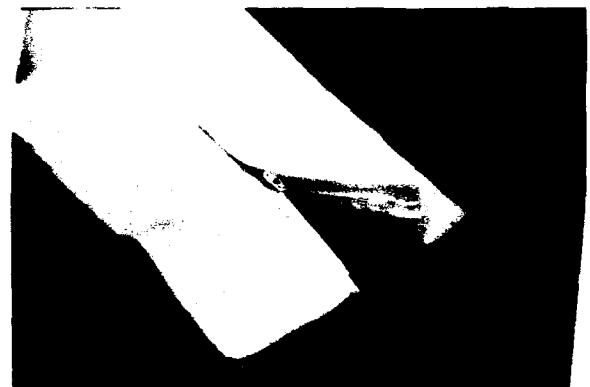

Face view of lap zipper application.

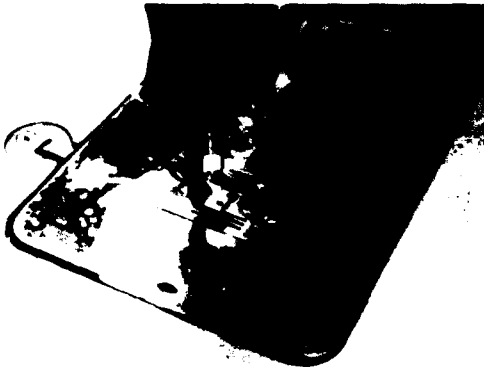

Zipper foot attachment for invisible zipper.



Guiding zipper through tunnel opening, zipper is stitched to one side of back opening.



Zipper is stitched to opposite side of garment seam while guiding zipper through tunnel opening.



Stitching center back seam area below zipper.



Inside view of the invisible zipper application.



View of invisible zipper application on face side of garment.



Fold over edge of coin pocket and stitch.



Top edge of coin pocket operation completed.



Position coin pocket to bottom lining fabric section of right pocket.



Turn under edges and apply pocket to surface using patch pocket method.



Coin pocket assembly procedure completed.

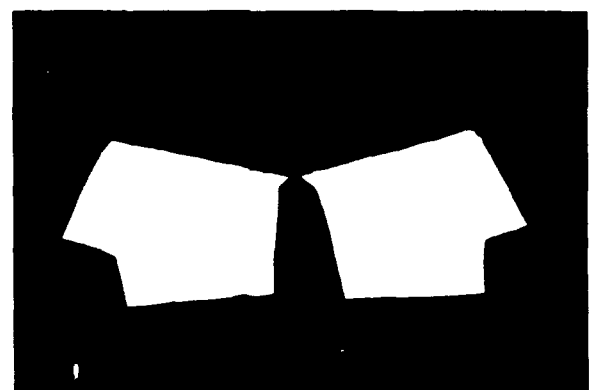

Assemble pocket lining section to yoke section of shell fabric.



Press seams open before next assembly procedure.

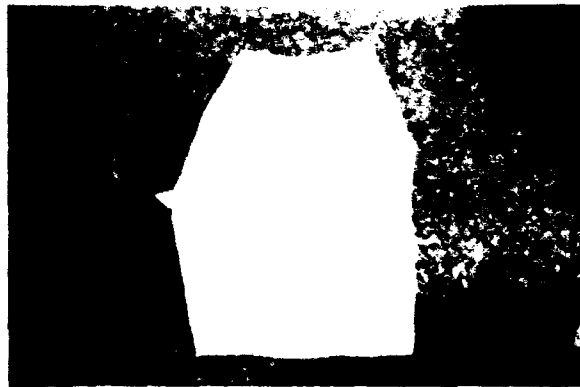

Pocket facing of lining fabric and yoke section of shell fabric are assembled and pressed.



Fusible interfacing is applied to pocket hem of shell fabric section.



Pocket facing of lining fabric is applied to inside pocket edge.



Fold pocket hem on fold line in preparation for underpressing.



Press lower side front section to set fold.



Lower side front section completed for next sequence. Top stitch upper edge.

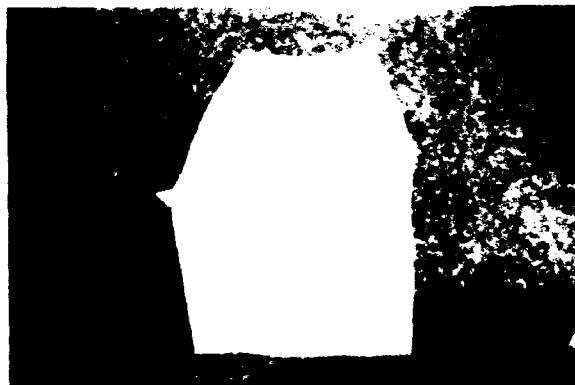

Upper side front section to be joined with lower front section to complete pocket.

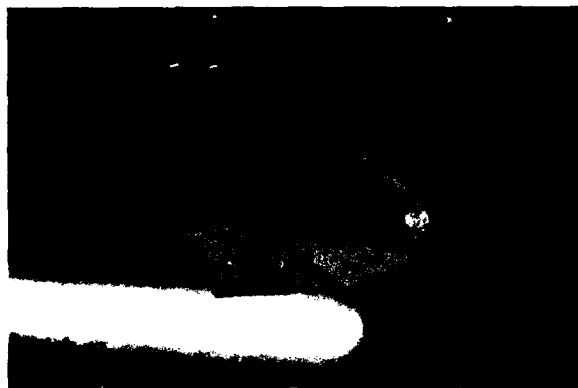

Match fold of pocket hem to notches on shell fabric yoke.



Stitch inside seams of pocket together starting from pocket fold, across bottom and up to opposite side.



Pocket assembly procedure complete.



Overedge stitched pocket starting from pocket fold line.



Continue overedge across bottom.



Complete overedge to opposite fold of pocket.



Overedge operation completed.

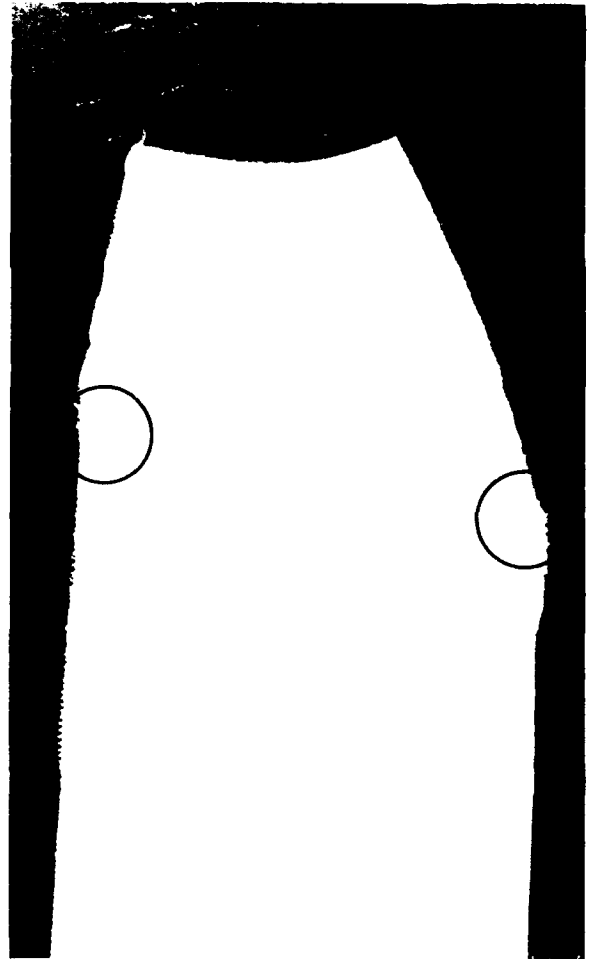

Trim thread and tack fold of pocket through all thicknesses.



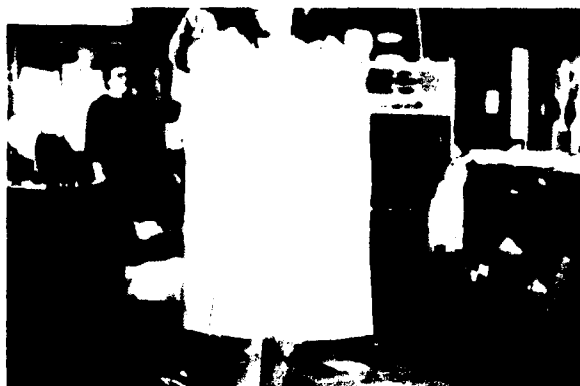

Side front sections have been joined to center front section.



Press seams closed first.



Open seams.



Press seams open.

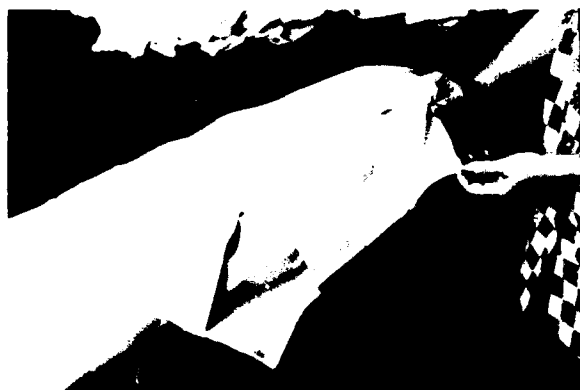

Check areas at pocket section and press if needed.

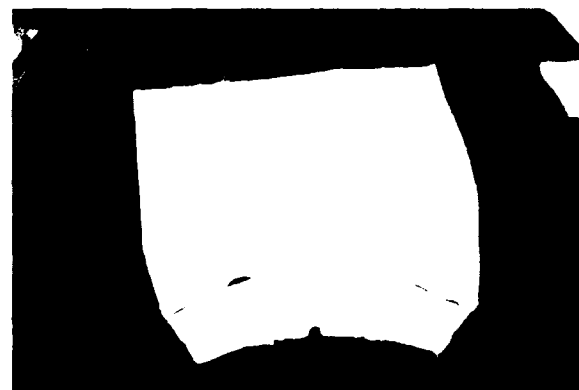

Front section completed.



Matching seams, place front and back skirt sections together.



Stitch side seams together.

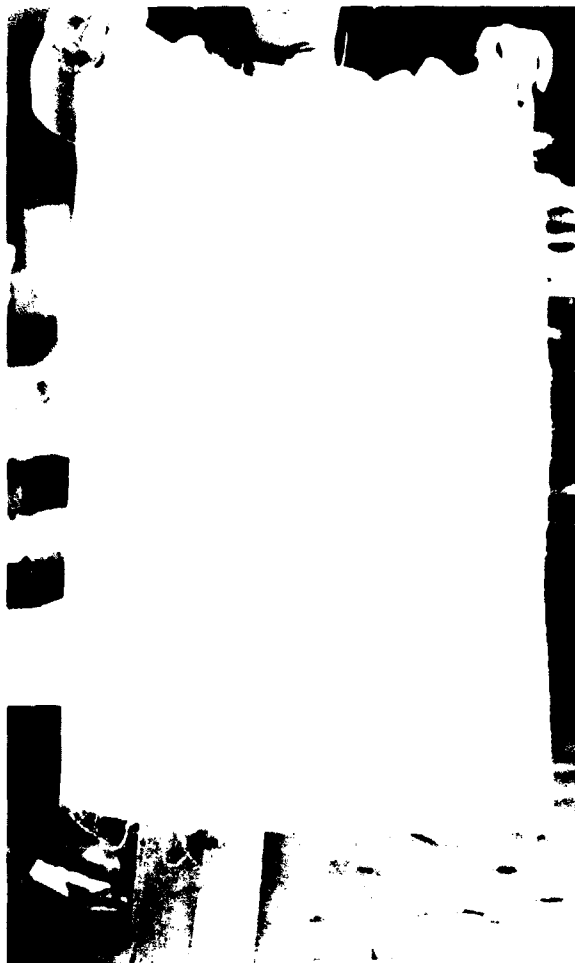

View of front skirt section after assembling operation.

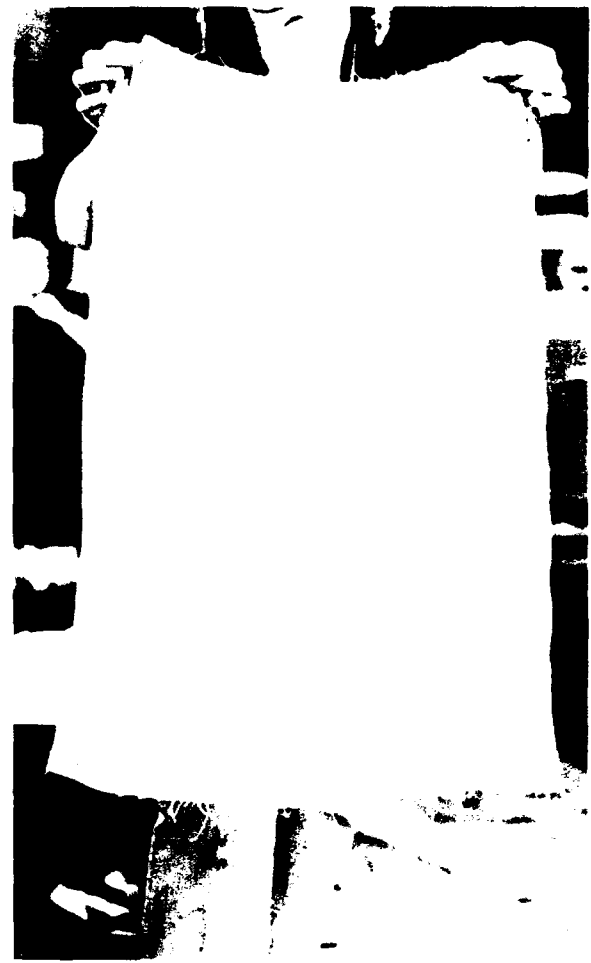

View of back skirt section.

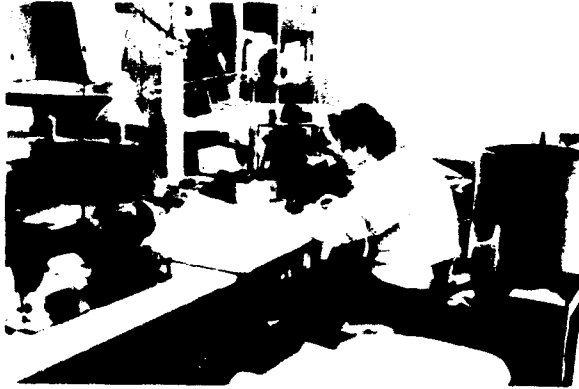

Center back sections of lining are joined leaving openings for zipper and slit.



Assemble front and back of lining. Stitch side seams.

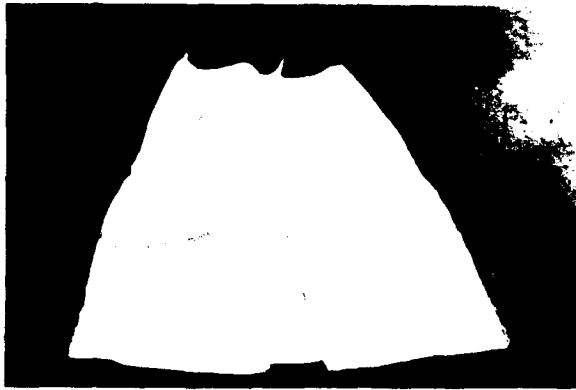

Lining sections assembled and slit opening is hemmed.



Center back and side seams are pinked on pinking machine.

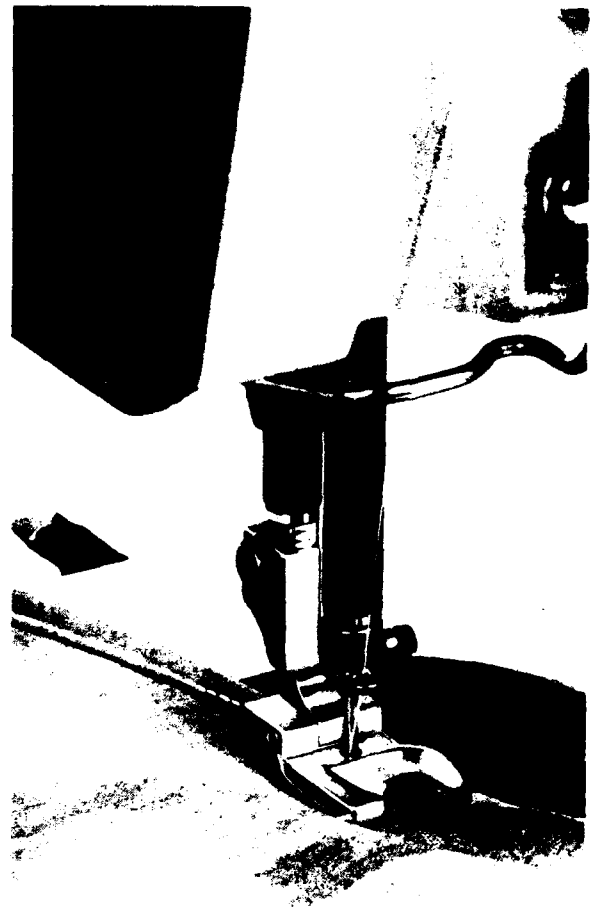

Hemmer foot attachment is used to finish hem edge of lining.



Attach lining to shell at zipper opening.



Both sides of lining attached to shell at zipper.



Turn skirt parts to match lining and shell at waistline. Stitch together starting at zipper opening.

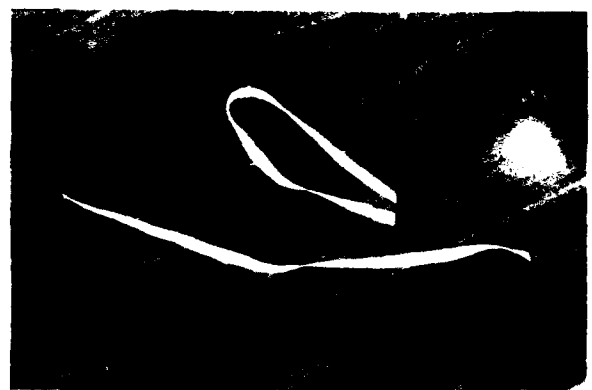

Prepared skirt hanger strips.



Attach hanger strips to form a loop at side seam intersections of skirt waistline.



Stitched waistline of skirt lining and shell with hanger strips completed.

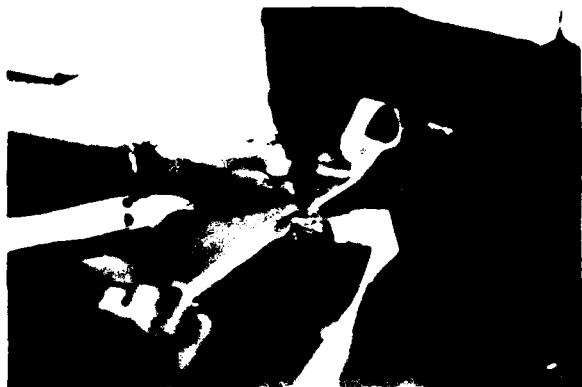

Bias binding in folder for application to waistband edge.



Bias binding attached to lower edge of waistband to provide clean finish.



Pressing waistband after binding application in preparation for next sequence.



Waistband, elastic and cut elastic strips ready for next assembling sequence.



Match waistband seam to skirt waistline seam and stitch together.



Place marks at inside of waistband for application of elastic.

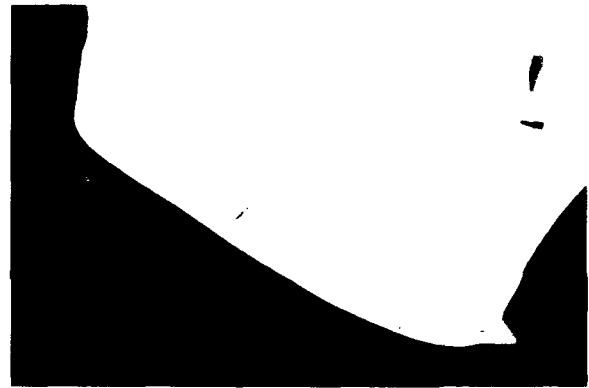

Position elastic strips to marks.



Stitch elastic to waistband marks.



Both pieces of elastic strips stitched to waistband.



Stitch ends of waistband closed.



Point turner.



Sewn corner of waistband and point of turner.



Position corner of waistband over point.



Corner of waistband turned.



Corner turning operation completed.



Fold waistband and following seam line, stitch through all layers from face of garment. "Crack Stitch".



Elastic area of waistband is pulled taut while stitching in crease of seam.



Waistband stitching operation completed.





Apply hook to waistband.



Secure hook to fabric.



Apply bar to opposite end of waistband.



Hook and bar application completed.



Inside view of hook closed over bar.



Appearance of hook and bar closure.



Ready seam tape/seam binding for hem edge of skirt.



Application of seam tape to hem edge.



Blindstitch hem on blindstitch machine.



Clip seams at pleat and hemmed intersection above seam tape.



Seam clipped to release hem area in pleat sections.



Fold hem area at pleat seam and stitch to hold pleat in place.



Using steam iron for final pressing in traditional factory setting.



Using pressing buck for final pressing in traditional factory setting.



## CHAPTER 3

# AUTOMATED PLANT ADVANCED MANUFACTURING PROCESS

The apparel industry is moving towards a greater degree of automation. Some designing, pattern generation, and production procedures lend themselves readily to computer assisted automation.

A designer's knowledge about the manufacturing process allows for suggesting ways to alter or approve a design which may more efficiently employ various aspects of the automated manufacturing process.

The developed technology base for automated manufacturing optimizes production time and quality consistency. The operations and sequences performed in an automated plant facilitate the use of computers and electronics to enhance productivity.

Special purpose machines, from the inspection of piece goods through cutting, sewing, finishing and pressing, have been developed and employed to address specific needs.

An automated plant may be configured with modular layout, incorporating a team approach in the manufacturing and assembling of a garment, or may employ the use of unit production systems for moving garment parts and sections from one station to another.

Computer simulation, when it becomes readily available, may be used to view the manufacturing set-up prior to the actual assembling of the garment. Through simulation studies the type and number of machines as well as the number of operators needed for specific operations may be determined before the assembling process starts.

To maximize the utilization of this type of equipment and machinery for manufacturing the skirt sample followed in this study, changes to the pattern were necessary. As shown on page 72, the center back seam allowance was reduced and the inverted pleat was eliminated to take advantage of the automatic seam stitcher. The shape and size of the side back section seam, designed with a side pleat, was changed to eliminate drill holes for stitching and to provide more efficient alignment of seams as shown on page 152, in Chapter 6.

After assembling the pocket section of the skirt, the application of the pocket was evaluated. To take advantage of production efficiency and ease of manufacturing, the pocket was designed in the side seam of the garment. A pocket designed and constructed within the side seam of the garment requires fewer operations and less time to assemble than the pocket stitched within the hip yoke. However, the side seam pocket application would not allow for efficient use of automatic side seamers. Detailed illustration showing the application of the side pocket are on pages 146 and 147.

The coin pocket could be applied within the waistline seam or applied as a patch pocket on the pocket lining. If the patch pocket application is used, an automated pocket setter could be used to apply the coin pocket. The size and shape of the pocket would be designed to best utilize the equipment.

An automatic dart stitcher may be utilized to stitch the darts in the skirt lining.

The sequence of operations in an Automated Plant are arranged to best suit the plant layout, equipment, and skill of the operator. With UPS, sequences can be changed easily, giving more flexibility to the designer for construction alternatives.

Following is a list of equipment and tools that may be found in an Automated Plant. A sequence of operations showing the utilization of various automated and programmable machines follows the equipment listing and illustrations.

#### **EQUIPMENT AND TOOLS THAT MAY BE FOUND IN AN AUTOMATED PLANT:**

**CAD/CAM computer work station**

**Computer controlled cloth inspection system to locate flaws, recognize color differences, and determine width variations**

**Computerized cut order planning utilizing data to determine what markers should be made, how fabrics should be spread and cut, and the most cost effective number of plies, colors, and size mixes**

**Marker information for automatic spreading and cutting**

**Automatic spreading and cutting**

**Automated bundle identification systems**

**Cutting procedures connected to subsequent manufacturing processes by a transport system moving both material and information**

**Material handling systems such as unit production systems (UPS) incorporating advanced software and technology**

**Automatic piece identification ticketing system**

**Fully automated serging units with stacker**

**Semi-automatic serging units with stacker**

**Automatic seaming units/profile stitchers**

**Programmable seaming units for various operations**

**Vacuum jet cleaning units**

**Computer controlled pressing**

Computer integrated units to be found in an Automated Environment.

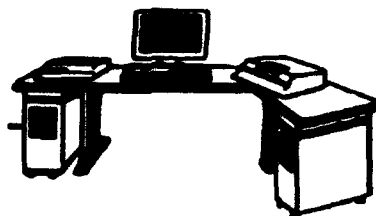

COLOR GRAPHICS WORK STATION

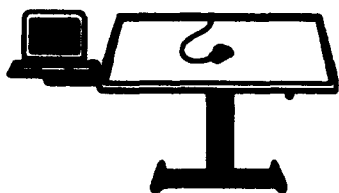

ELECTRONIC DIGITIZER

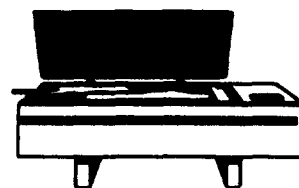

PATTERN SCANNER

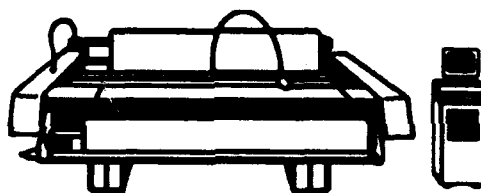

HIGH SPEED PLOTTER

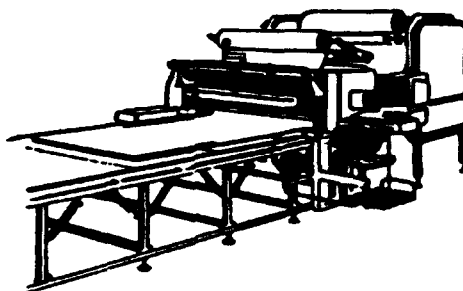

ROBOTIC SPREADER

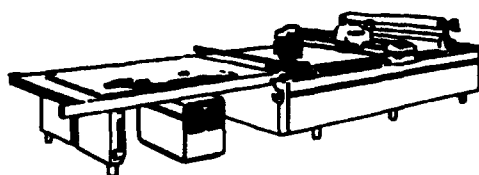

HIGH PLY KNIFE CUTTER

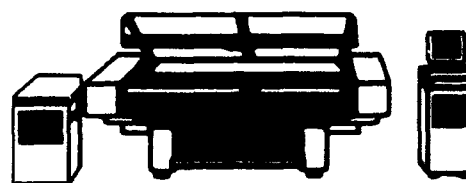

LASER PATTERN CUTTER

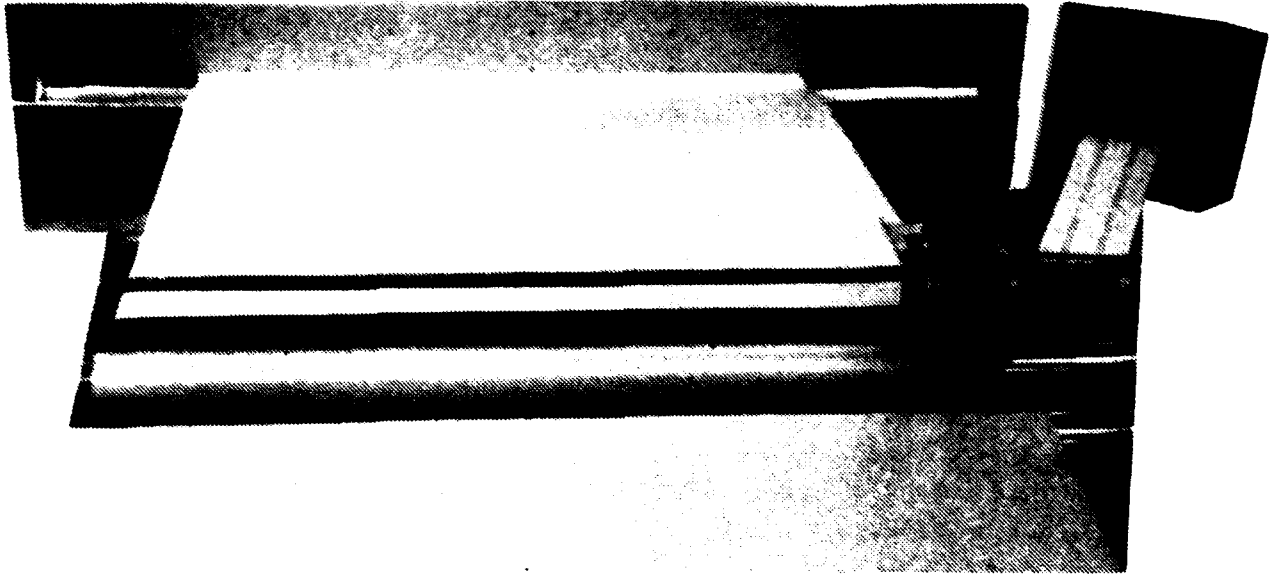

Computer controlled cloth inspection machine to locate flaws, recognize color differences and determine width variations.

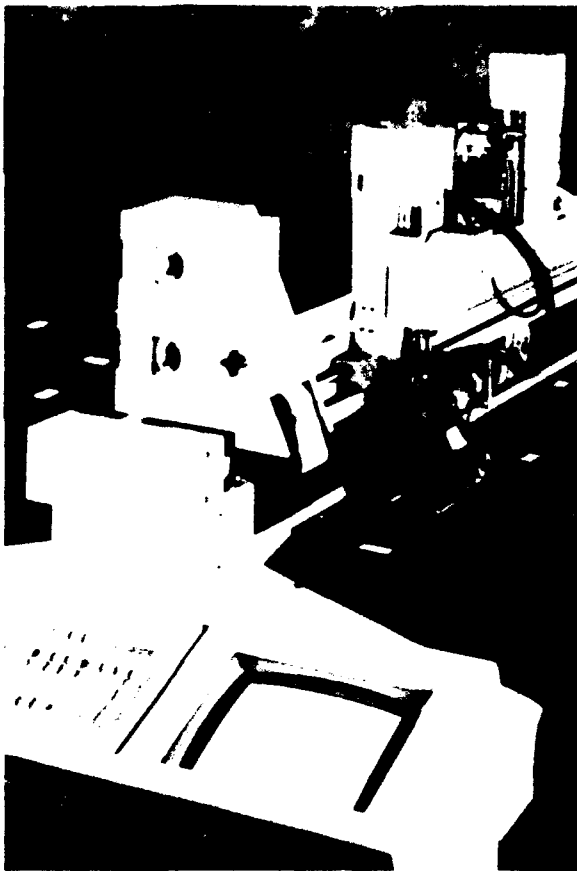

Computerized cut bundle identification system. Data files generated automatically from the same cut data file that drives automated cutter.

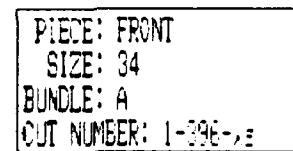
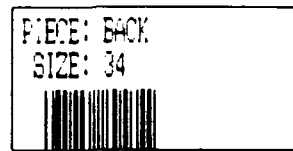
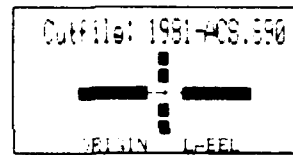

Labels displaying alphanumeric and/or bar coded information. Adhesive backed labels are automatically applied to the top ply of the fabric prior to the cutting operation.

Photographs and information courtesy of:  
 Measurements Research Inc., Providence, RI.  
 Apparel Technology Systems, Inc., South Windsor, CT.



Automated Plant - Advanced Manufacturing Process

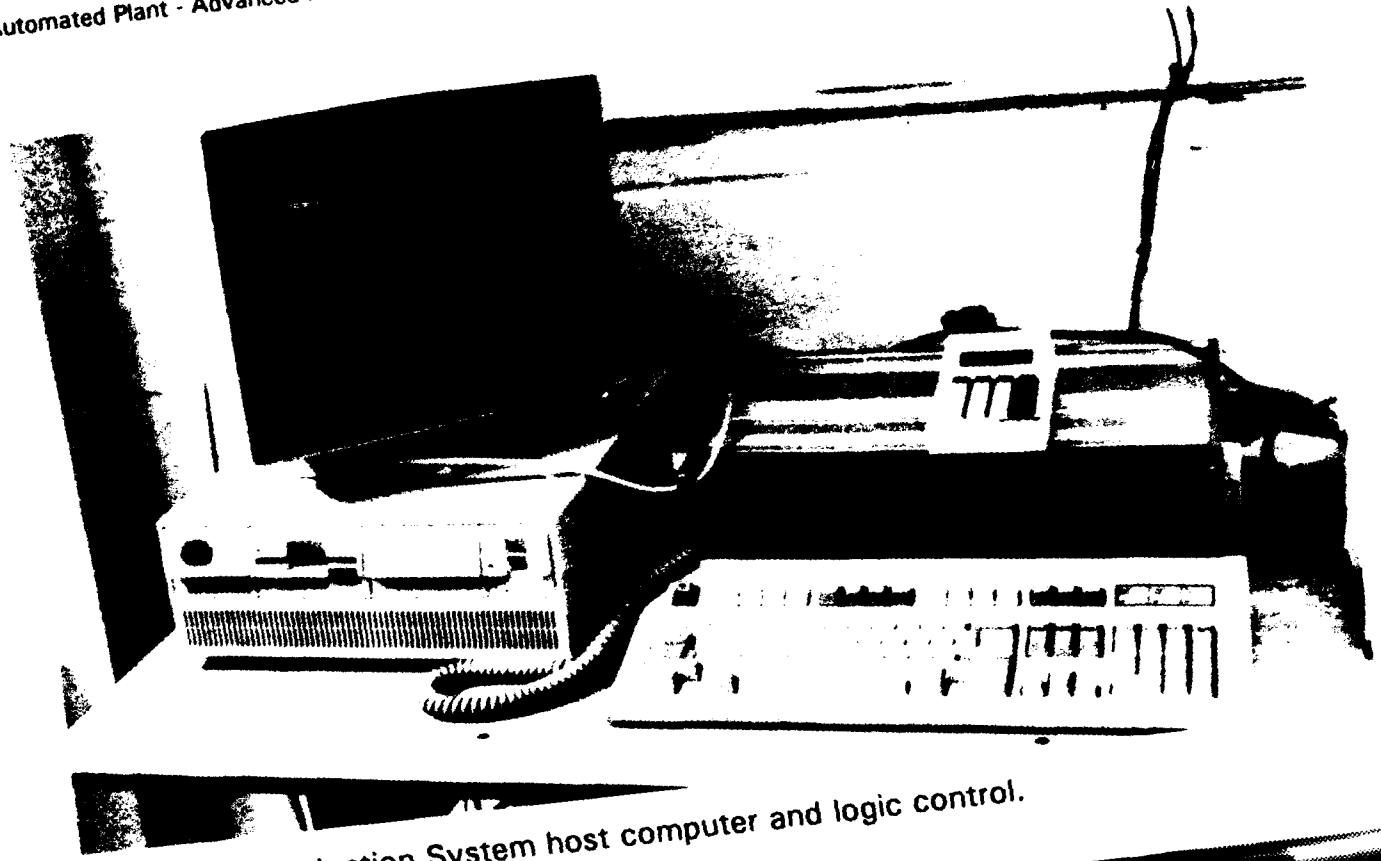

Eton's Unit Production System host computer and logic control.

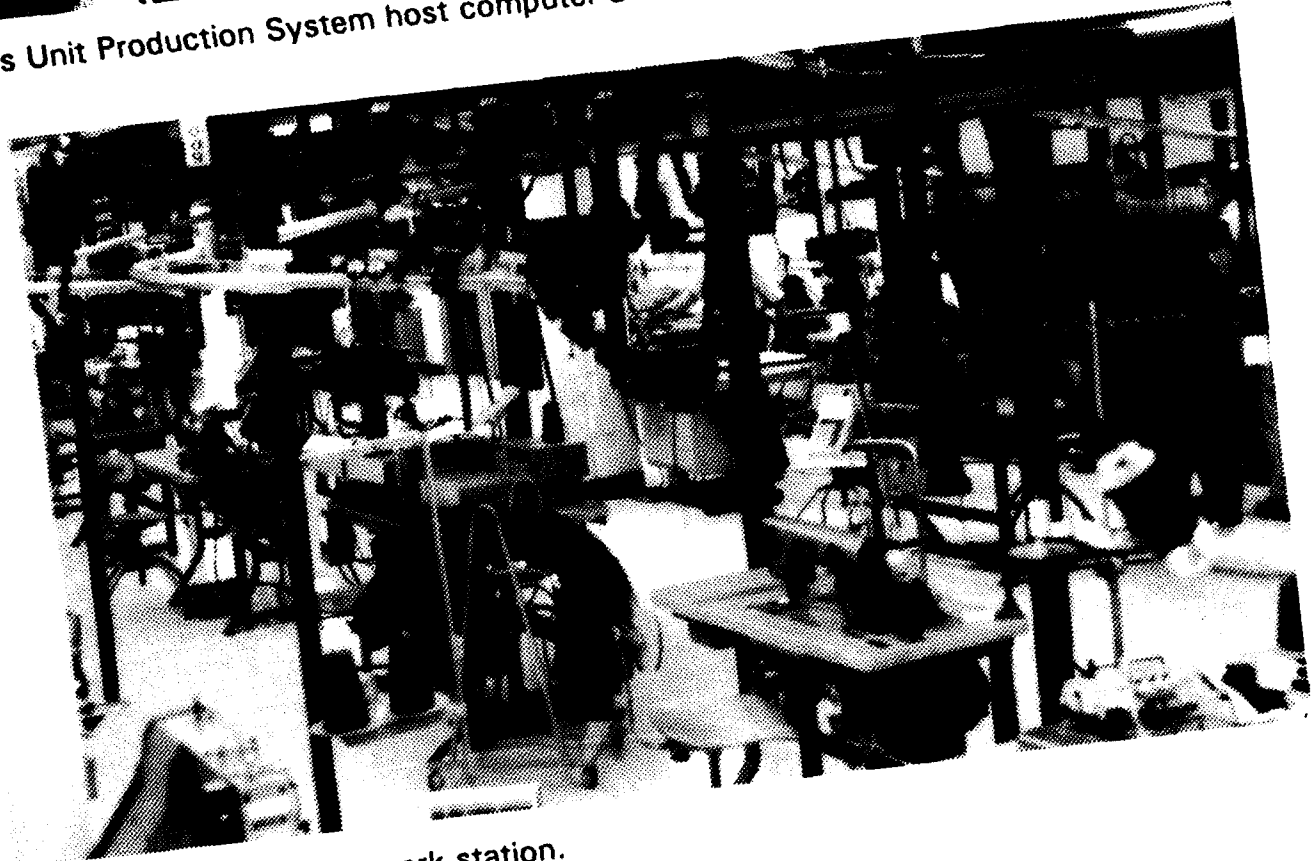

Unit production system work station.

DESIGN FOR MANUFACTURING AND ASSEMBLY IN APPAREL

## SEQUENCE OF OPERATION IN AN AUTOMATED PLANT:

### I GENERATING CUT WORK:

Check pattern pieces  
 Digitize pattern pieces  
 Check data entry  
 Develop marker  
 Plot marker  
 Cut order tape  
 Check pieces in cut order data  
 Inspect fabric  
 Spread fabric  
 Program automated bundle ticketing  
 Program automated cutter  
 Cut  
 Sort pieces  
 Bundle and identify piece  
 Place pieces on UPS

### II ASSEMBLY: Operations on parts that may be performed individually and brought together for final assembly.

(A)	(B)	(C)	(D)
Skirt front	Skirt back	Waistband	Lining
Serge sections Hem coin pocket  Attach/Assemble: Coin pocket to pocket lining Lining to yoke Underpress Interfacing to pocket edge Pocket lining to pocket edge Lining to yoke Underpress Lower edge to yoke panel Tack pocket Underpress Side panel to center front panel Press seams	Serge sections Sew center back seam Insert pleat underlay Underpress Insert zipper Join side panels Underpress Mark pleats Top stitch pleats Press seams	Apply interfacing to waistband Finish one edge of waistband* Press Attach elastic**	Sew darts Join center back Join side seams Finish seam edges Hem slit opening Hem zipper opening Hem lower edge Press
	NOTE: *Free edge of waistband may be overedged/serged or finished with bias binding. **Elastic may be applied after waistband is attached to skirt waist.		

**III FINAL ASSEMBLY:**

Stitch front and back at side seams  
Press  
Attach lining at waistline  
Apply waistband  
Insert hanger strips  
Apply closure  
Close corners  
Turn corners  
Top stitch waistband

**IV FINISHING:**

Apply seam tape to hem edge  
Blindstitch hem

**V CLEANING:**

Remove threads

**VI FINAL PRESSING**

**NOTE:** Underpressing and piece pressing may be done with steam irons or pressing machines.

**SHELL FABRIC PATTERN PIECES**

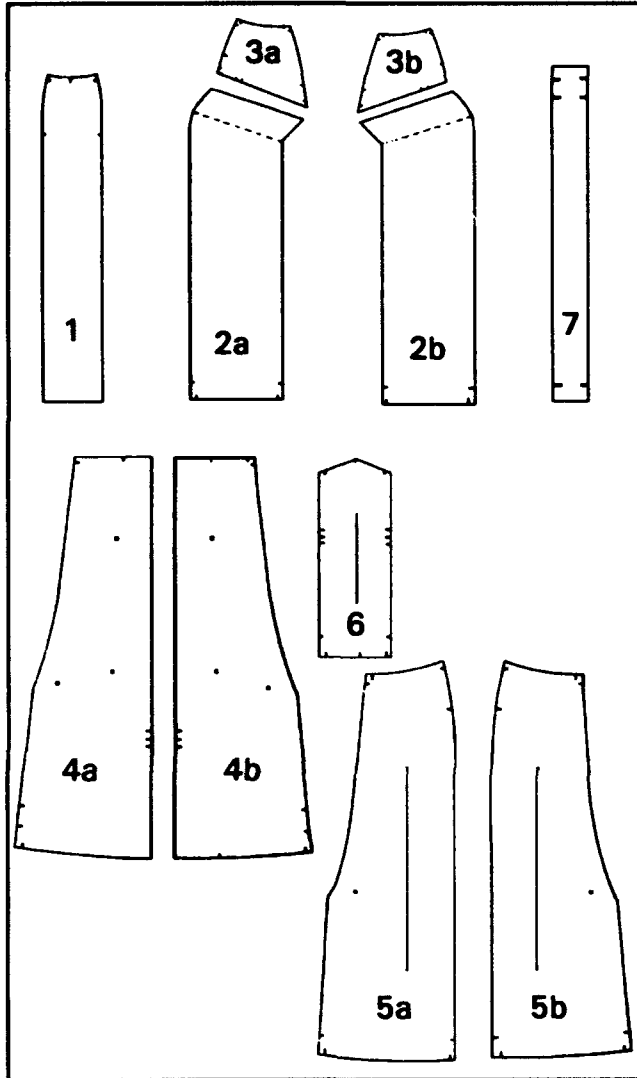

CUTTERS MUST			
Compare this Ticket with Materials, Patterns, and Cutting Ticket			
Style #		DLA 009	
Sample of		Women's skirt (tan)	
PATTERNS		YARDAGES	
For Shell Fabric			
PIECE #		CUT	
1	Center Front	1	Shell fabric
2	Side Front	2	Lining Fabric
3	Side Front Yoke	2	Fusible interfacing fabric
4	Center back	2	Waistband interfacing (on roll)
5	Side Back	2	(1 7/8" slanted center and esom)
6	Pleat Underley	1	Waist elastic 7/8" (on roll)
7	Waistband	1	
REMARKS			
For Lining Fabric			
8	Front	1	MARKERS FOR:
9	Back	2	Skirt Shell Fabric #
10	Inside Pocket	2	Skirt Lining Fabric #
11	Pocket Facing	2	Pocket Interfacing Fabric #
12	Coin Pocket	1	
TEMPLATE			
Waist elastic 7/8" X 4 1/2"			
Pleat marker			
For Interfacing Fabric			
13	Pocket flap	2	TRIMMINGS
	Waistband (on roll)	1	zipper
			hook & bar closure
			hanger hooks 10" long
			esom binding/esom tape (on roll)
			7/8" elastic (on roll)

**INTERFACING FABRIC PATTERN PIECES**

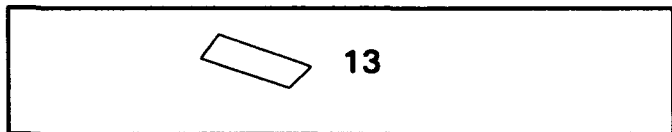

**LINING FABRIC PATTERN PIECES**

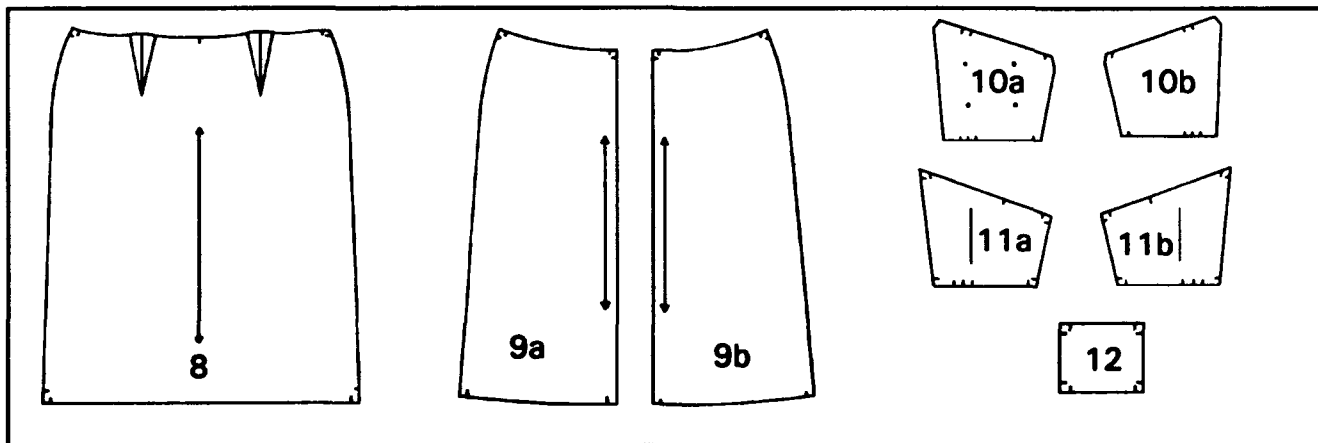

Pattern pieces of skirt used in Automated Plant Environment.



Checking pattern pieces against cutters must.



Checking patterns pieces for piece identification, grain line, and notches.



Checking pattern pieces for matched notches.



Digitizing pattern pieces into computer pattern storage area.



Computer work center with marker-making screen and pattern verification and work schedule screen.



Pattern pieces displayed to check grading and digitizing.

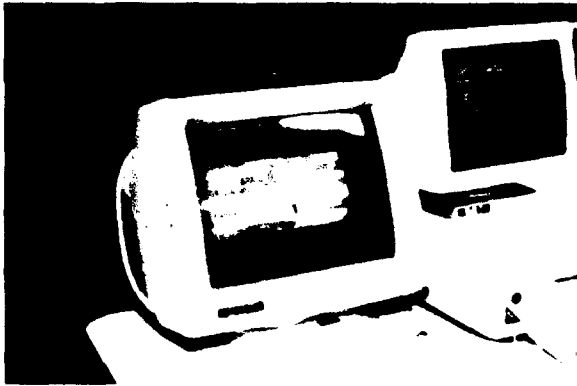

Planning and entering marker sequence by specifying sizes, fabric width and spread of fabric into the marker order file.



Edited and completed marker shown on screen prior to storage.



Entering the marker plot data into the plotter queue.

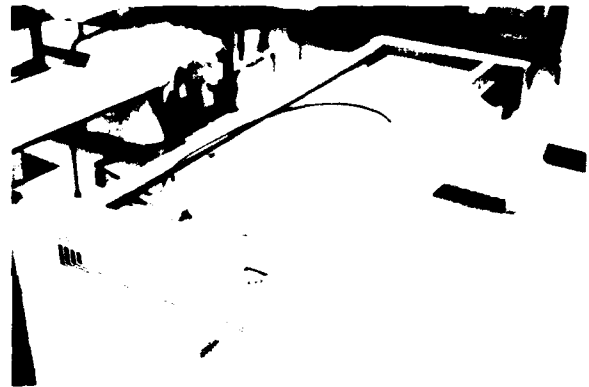

Flat bed plotter with moving pen assembly for drawing markers.



Plotter drawing out marker.

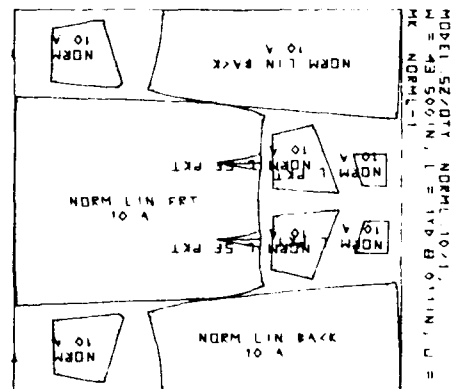

Finished marker for lining of skirt.

MODEL 152/DTY ; NORMS 10/2 ;  
W = 60.250 IN ; L = 1YD 31.340 IN ; U = 87.681%  
MK ; NORMS-1

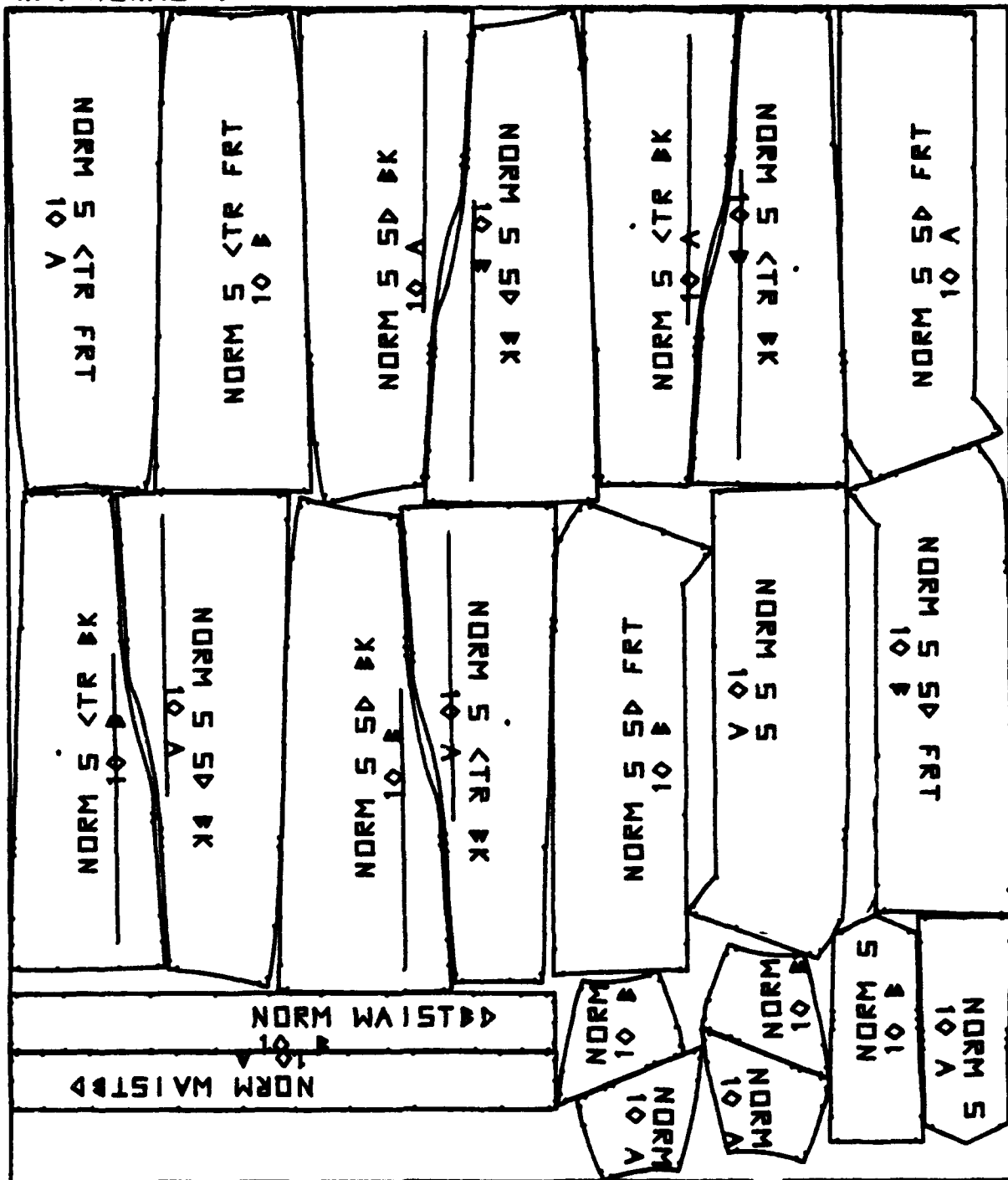

Computer generated marker for cutting of skirt shell fabric.



Preparing length of underlay paper to place on automatic cutter bed.

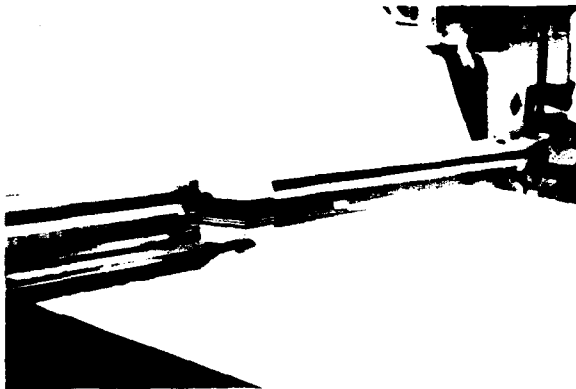

Automatic cut-off knife is used for face one-way direction/one-way spreading. It is programmed to cut automatically at end of ply.

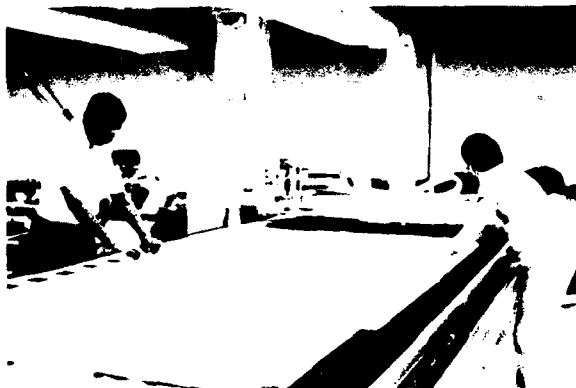

Spreading of fabric face up for open marker, for napped fabric and to avoid off-shade.

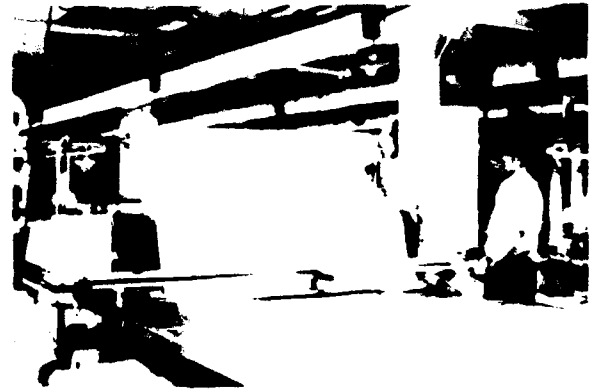

Automatic cloth spreader equipped with positive feed, edge guide and ply counter. Automatically stops when desired plies are spread.

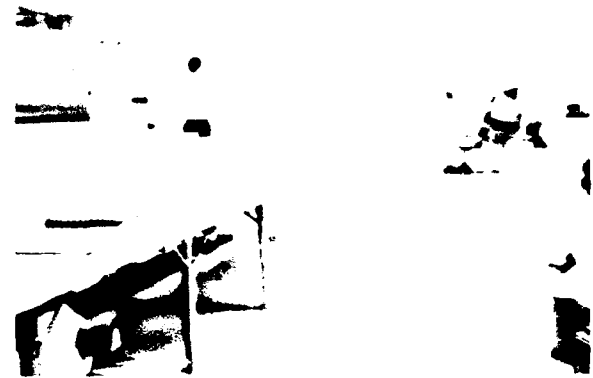

Automatic cutter bed.



Enter cut order disc to prepare for cutting.



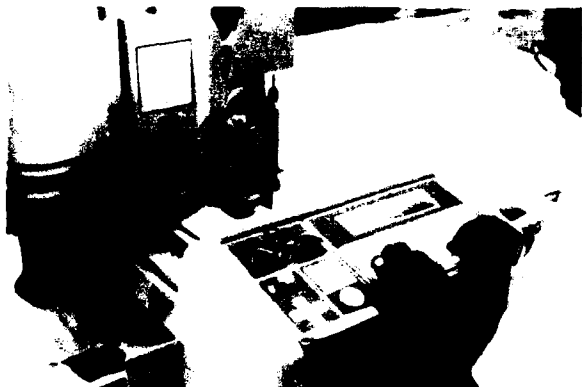

Computer control panel for cutter. Enter data.



Computer controlled automatic cutter.

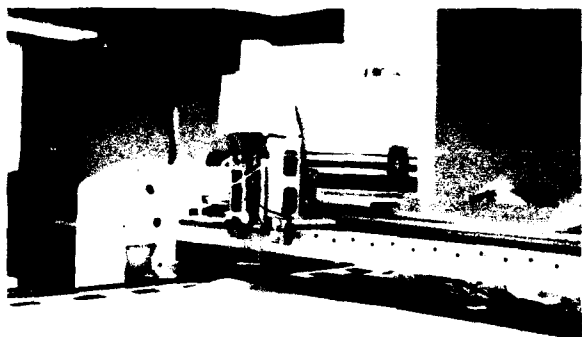

Cutter ready to start cutting operation.

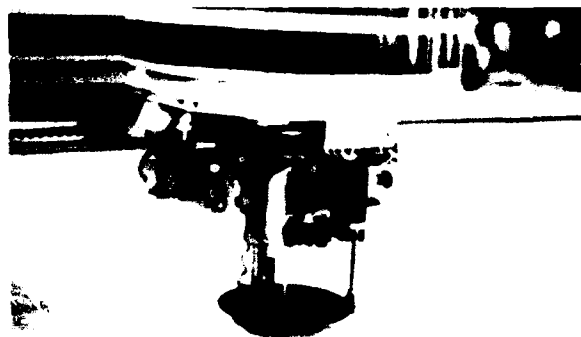

Cutting head cutting out sections of pattern from computer generated command.

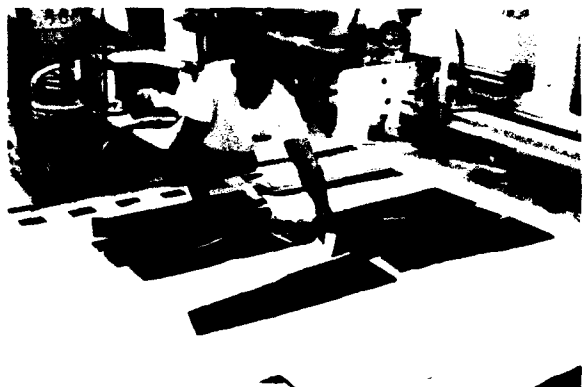

Cut sections lifted from fabric layup.

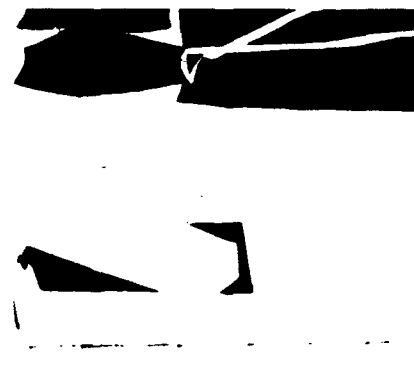

Kick pleat section of pattern from fabric layup.

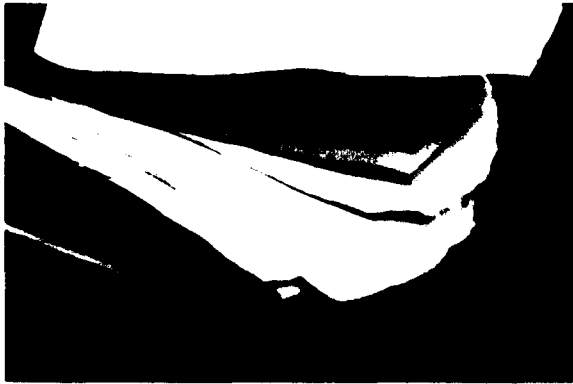

Component parts from cutting table.

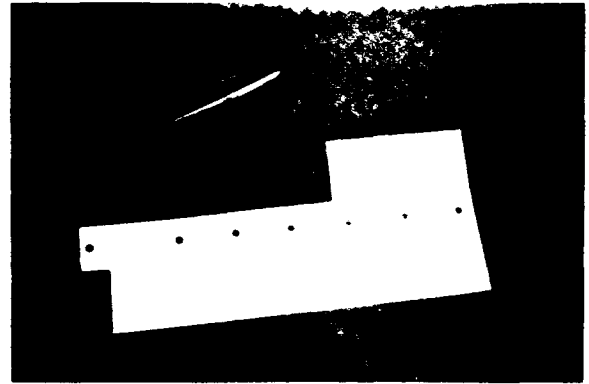

Bundle tickets.

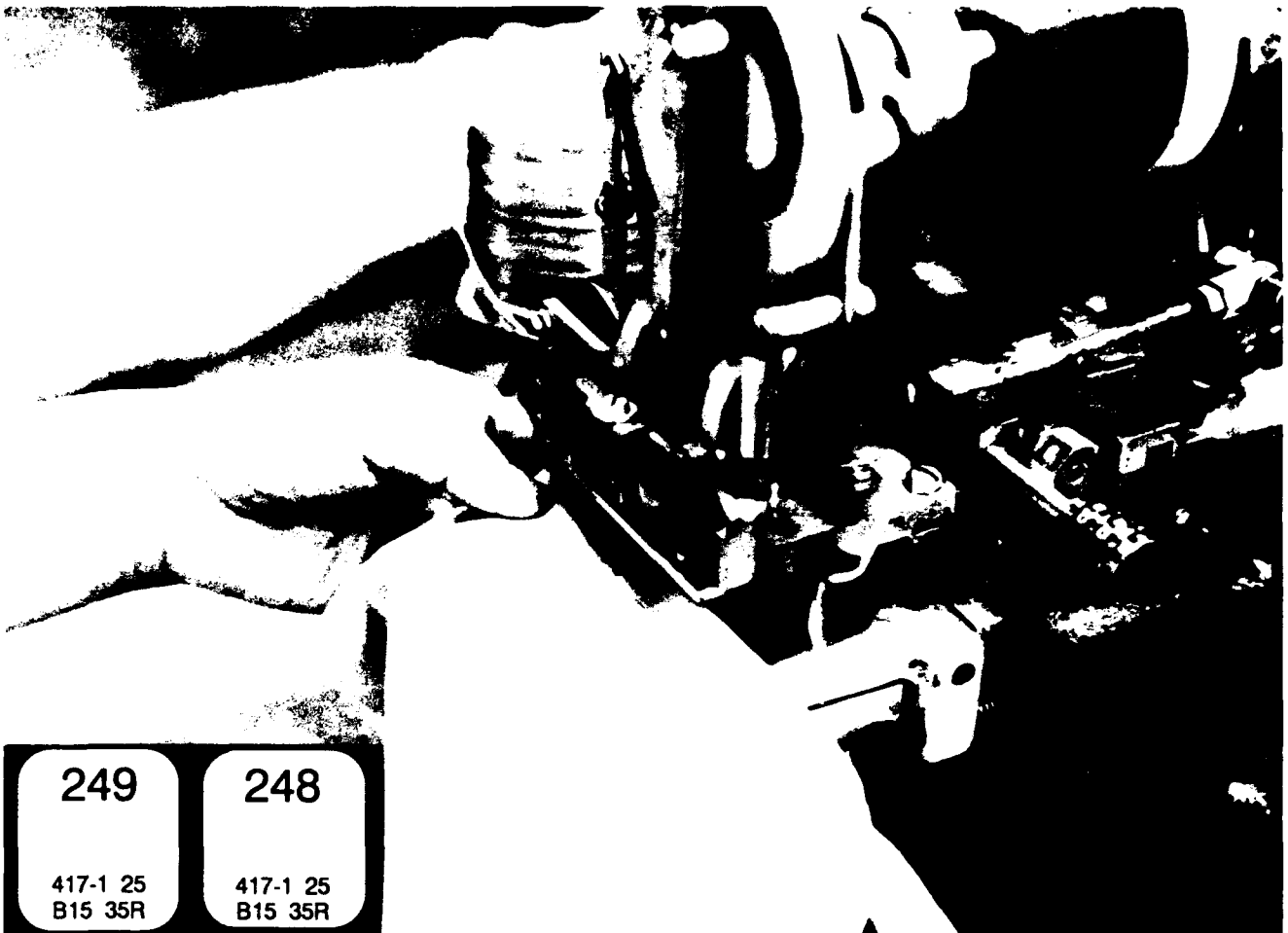

Attaching ticket by machine to a component part for shade marking. Ticket may be stapled or a self adhesive ticket may be applied.

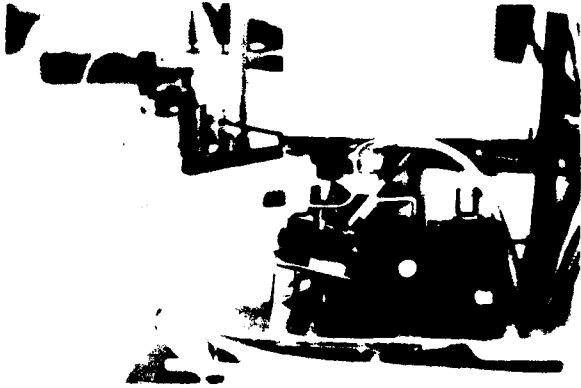

Fully automatic serging machine programmed to overedge three sides of skirt components.



Serging length of side back panel.

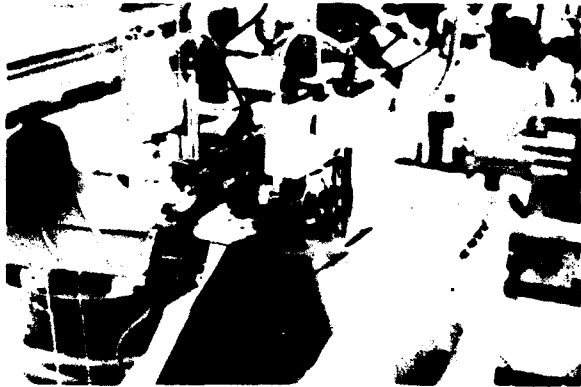

Serging top area.



Robotic arm positioned for turning function to serge third side of panel.

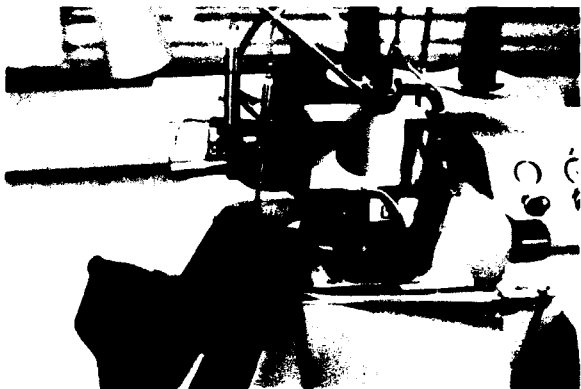

Serging operation completed. Skirt sections overedged on the automatic serging unit: Center front; Side front sections; Center back sections; Side back sections.



Serged pieces automatically moved to stacker when completed.

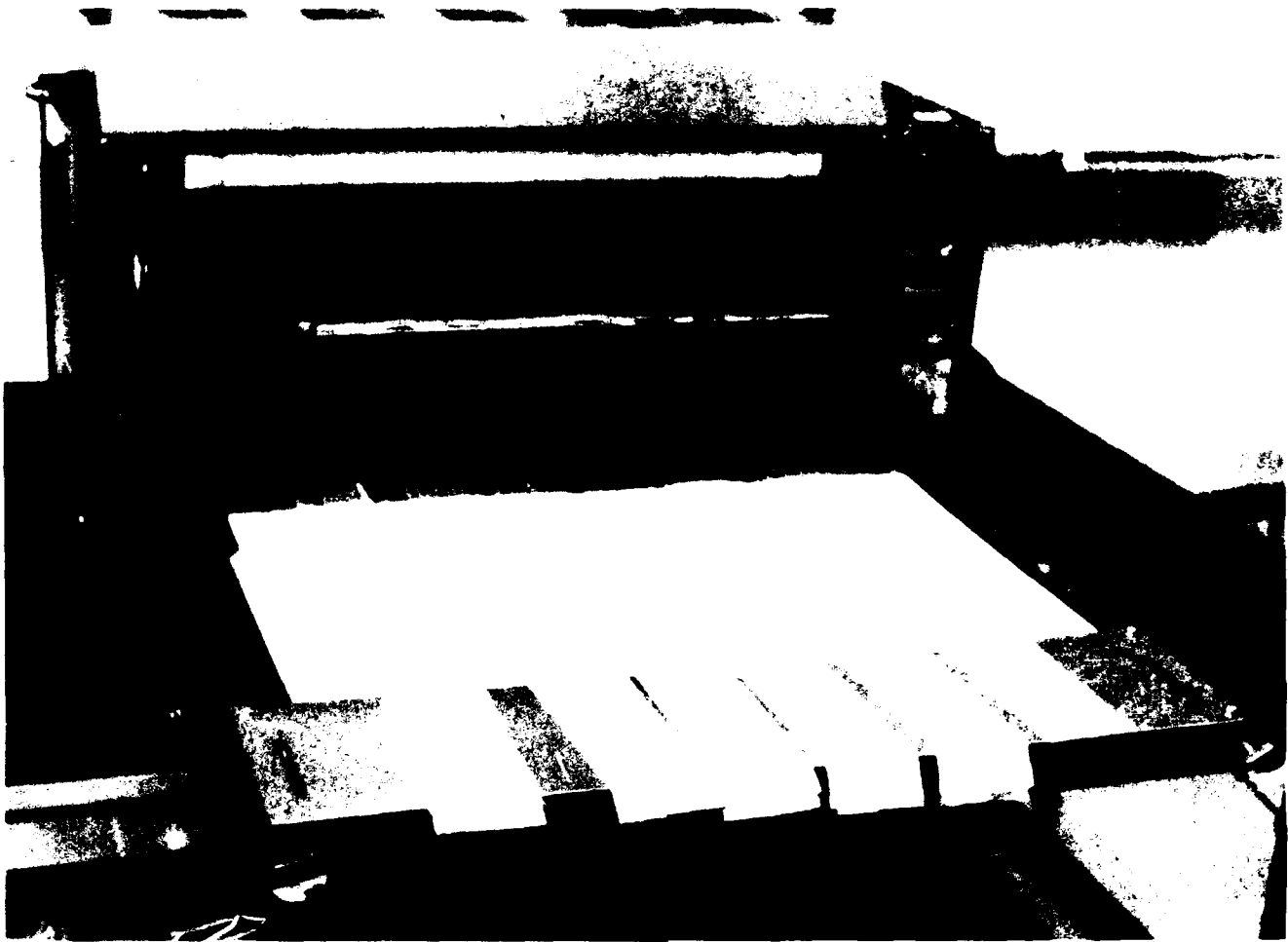

Applying fusible interfacing to waistband pieces using a programmable fusing machine with a continuously running belt.

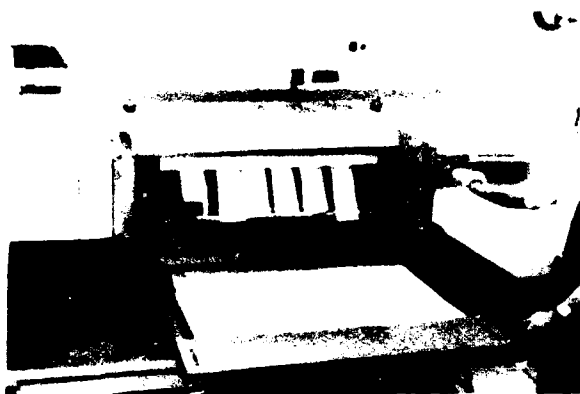

Fusing operation completed.

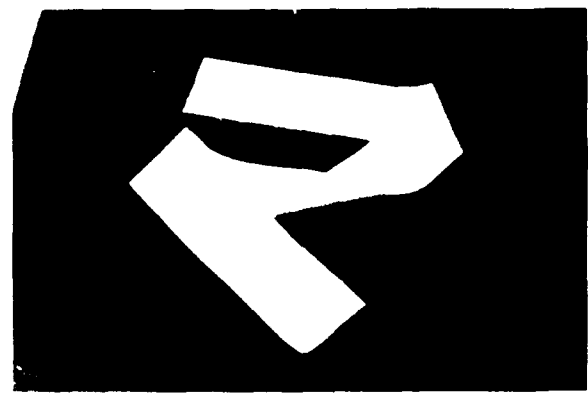

Waistband with fused interfacing.

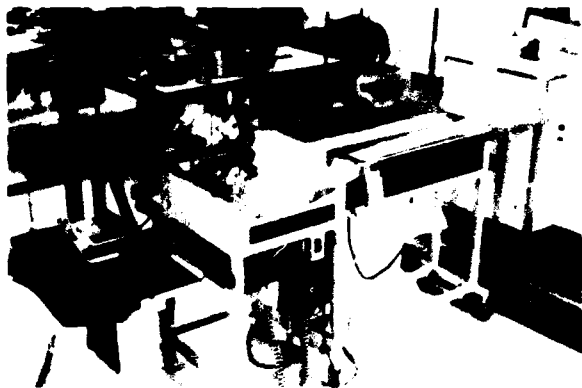

Lower inside edge of waistband serged on semi-automatic serger.

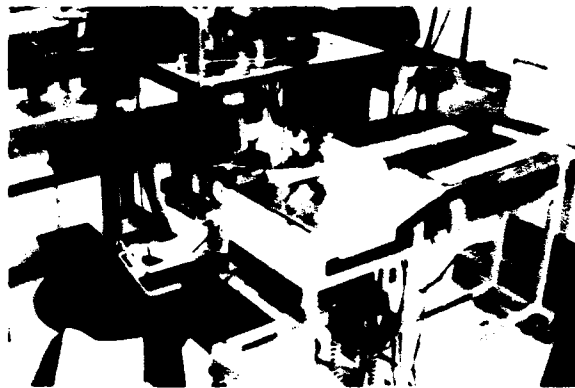

Serging waistband operation in progress.



Waistband serging operation complete.

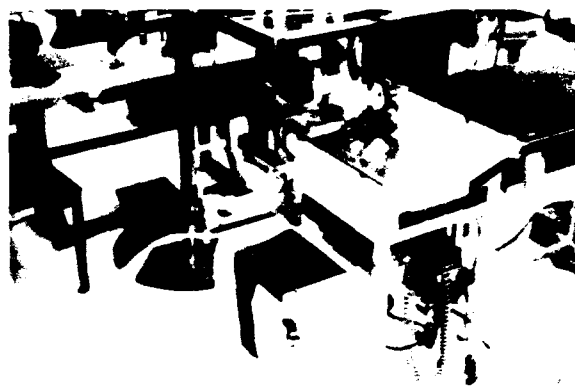

Completed waistband moved to stacker.

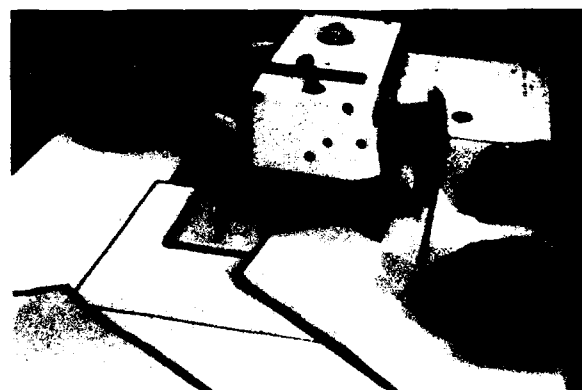

Serging the skirt parts on a serging machine.

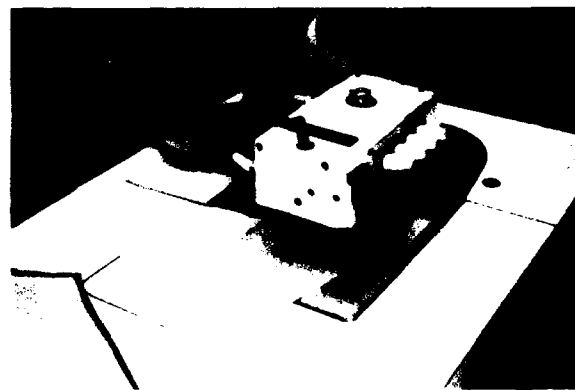

Underlay of kick pleat serged.

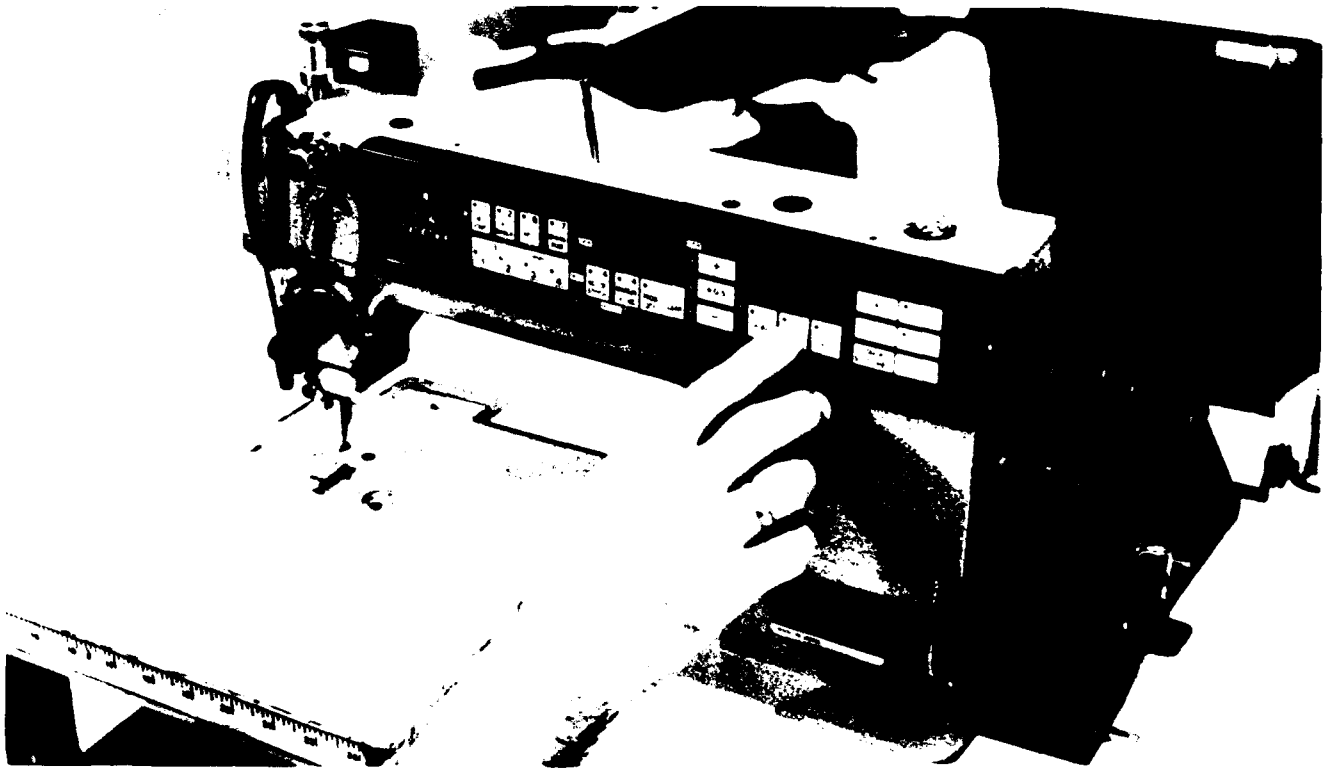

Programming a single needle lockstitch machine for various operations. Program operations include reading end of seam, stopping at edge, backtacking and thread trimming. Can be programmed with intermediate backtacking and automatic foot lift.

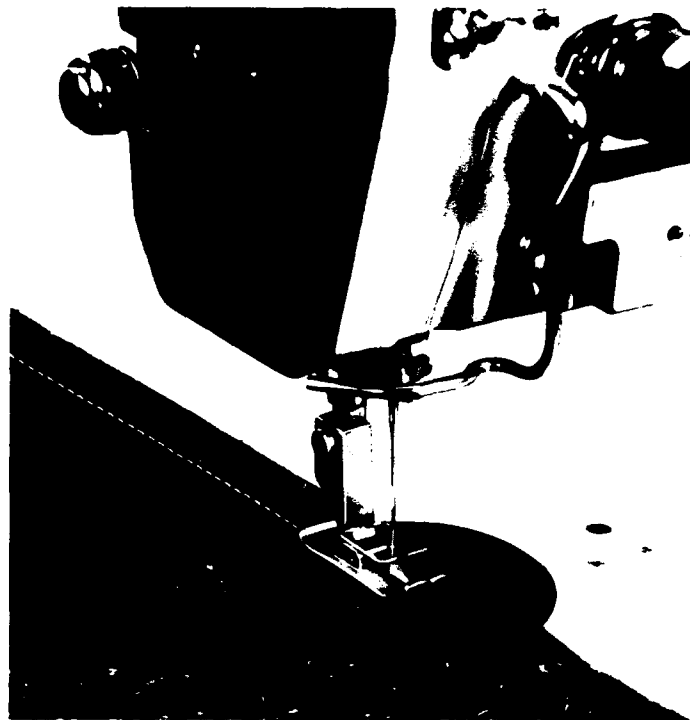

Lock stitch formation.

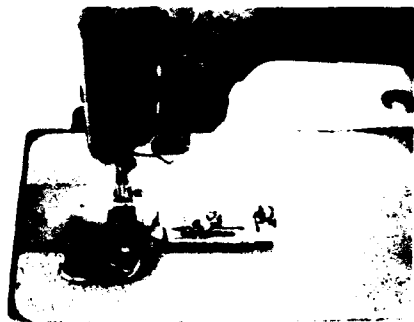

Hemming attachment.

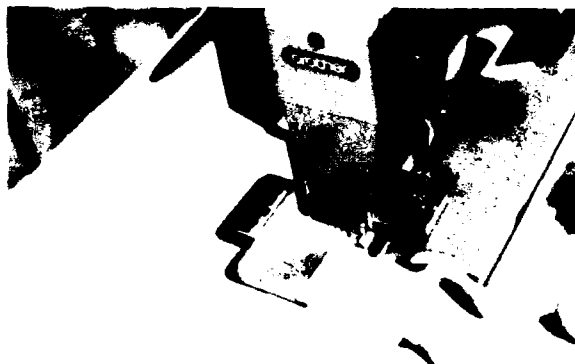

Hem edge of coin pocket using hemming foot attachment.

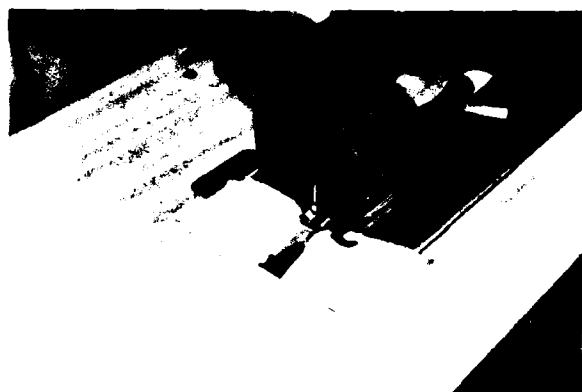

Hemming more than one coin pocket in succession.

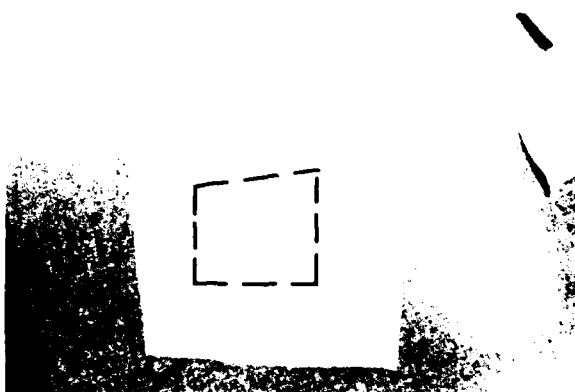

Attach coin pocket to pocket lining. Style has coin pocket on right pocket only.



Join pocket lining to shell fabric yoke section.

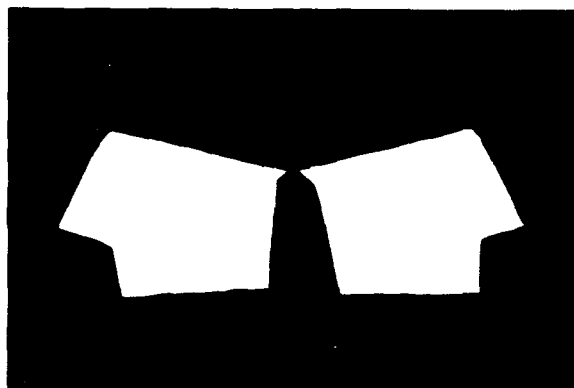

Right and left pocket lining and yoke sections joined.

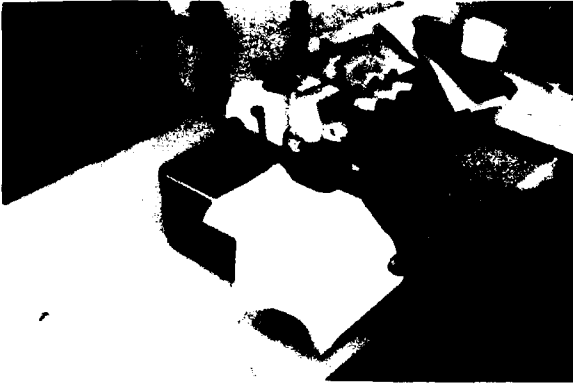

Overedge seams of joined pocket lining and yoke section.

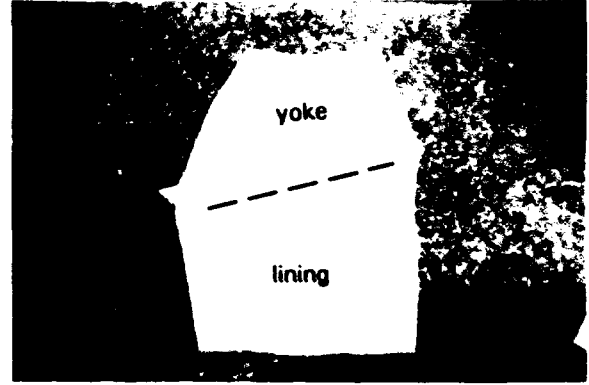

Press assembled sections.



Attach fusible interfacing to pocket fold line at top edge of side front section.

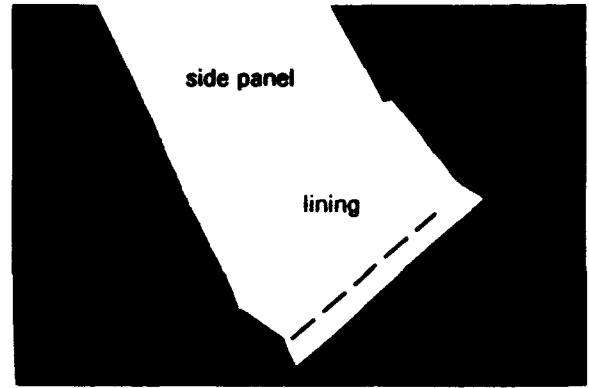

Attach inside pocket section (pocket facing) to edge of shell fabric.

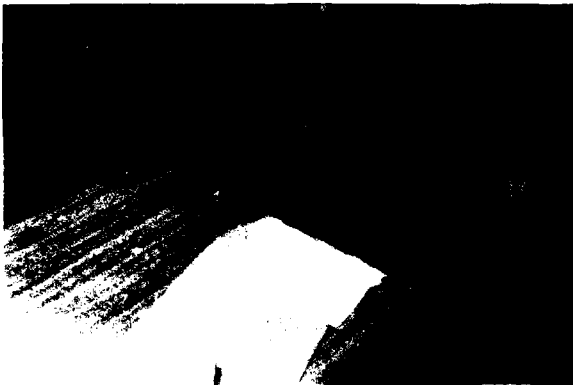

Stitch inside pocket section to panel.

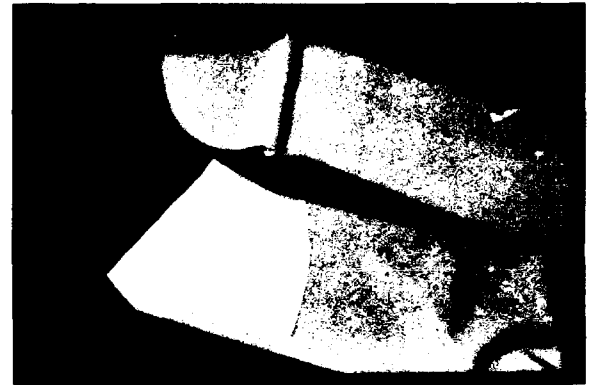

Right and left front side panels of skirt with inside pocket section attached.





Fold pocket section on fold line.

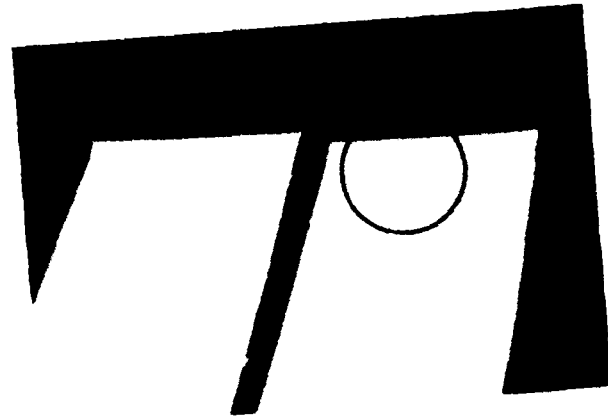

Press and topstitch upper edge of pocket.

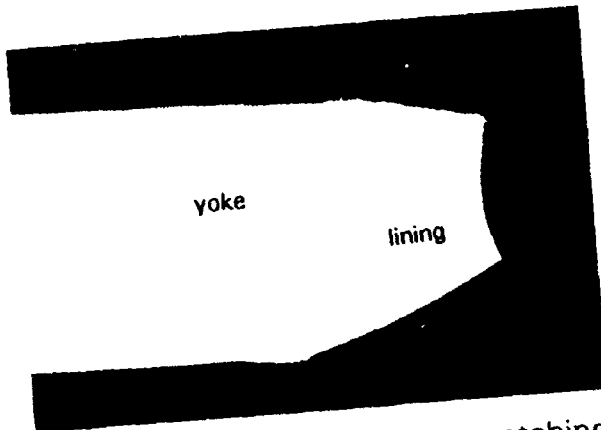

Place pocket edge to yoke, matching notch points.



Using lockstitch machine, stitch pocket sections together at seam areas.



Continue stitching pocket across bottom, matching sections.



Continue stitching to opposite edge of pocket.

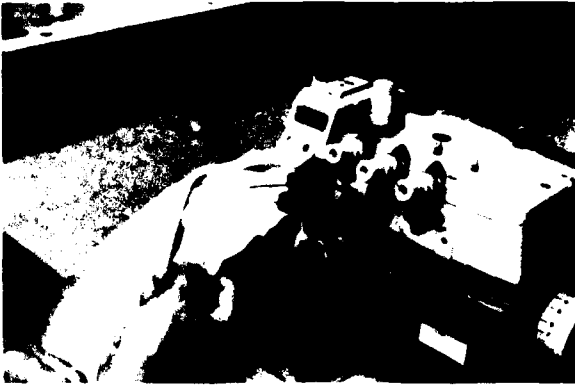

Serge pocket section starting from area under fold.



Continue serging operation along seam line to opposite side.

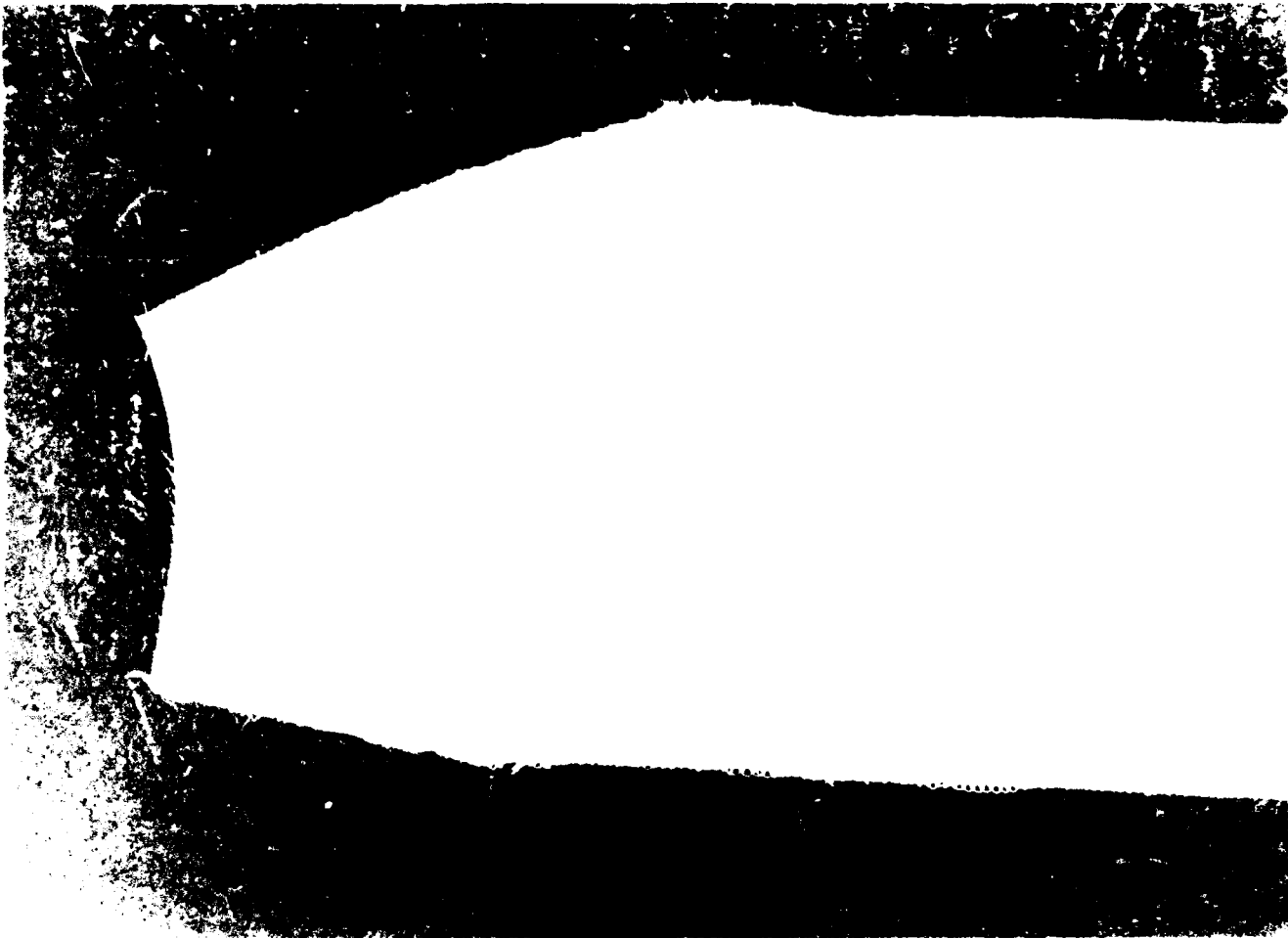

Serging operation of pocket section completed.



Join side front of skirt to center front panel.



Front section joining operation in progress.

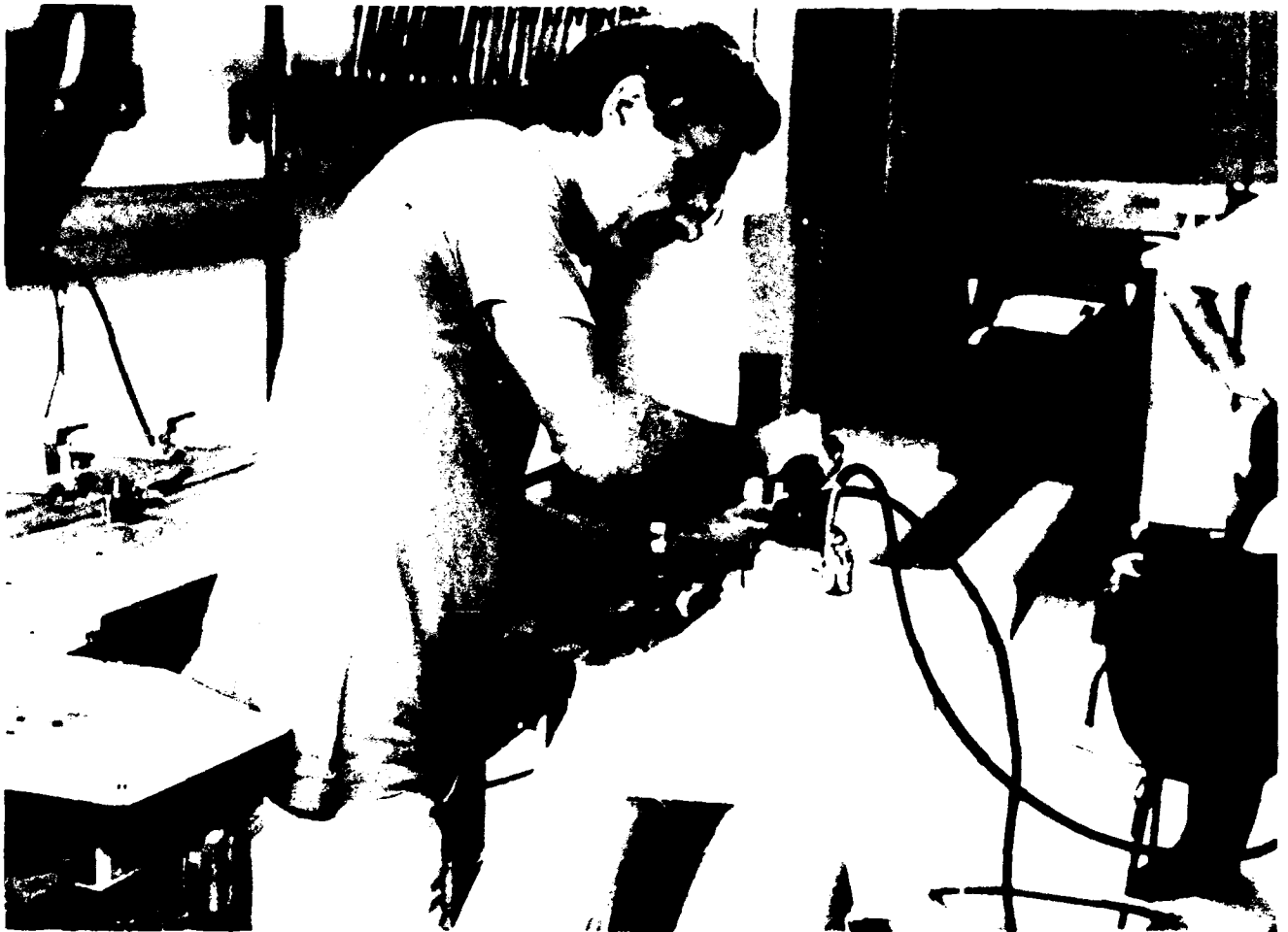

Press seams open with steam hand iron. Steam iron is a self contained unit with vacuum function.

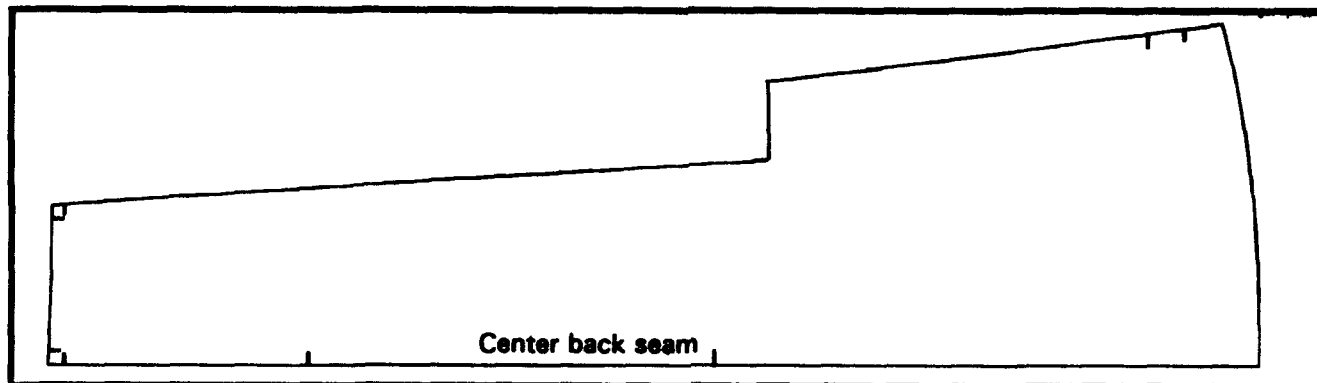

Skirt center back pattern sections if design were developed without kick pleat. Sections would be sewn on an automatic seam stitcher with self monitoring edge guidance.



Automatic seam stitcher. The internal computer controls the top and bottom feeding systems, the speed and all other functions of the machine.



Sensors activate the sewing operations.

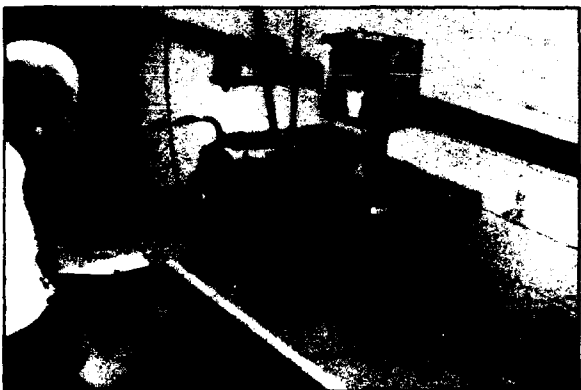

Sewing head sews seam together evenly.

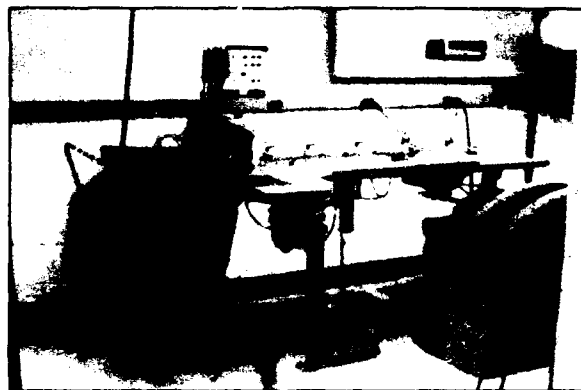

Upon completion, piece is moved to an automatic stacker.

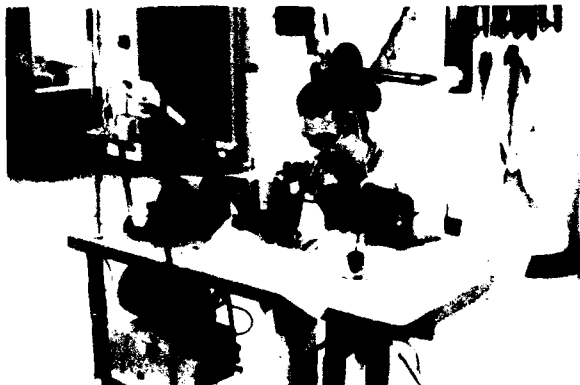

Center back section and kick pleat underlay move together on the UPS.



Kick pleat underlay is stitched into opening of center back section.

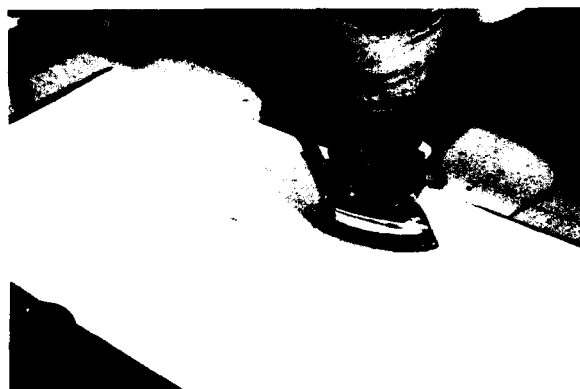

Press kick pleat and center back seam in place.

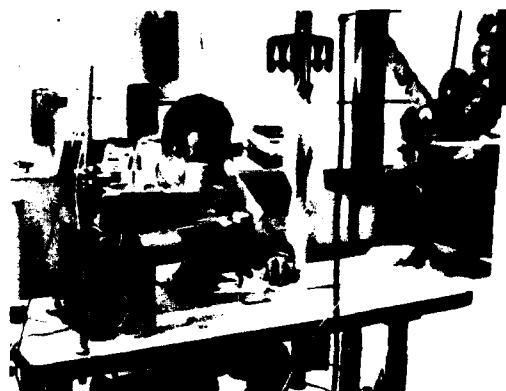

Attach zipper to center back opening.



Lap zipper application.



As zipper insertion application is completed, section moves on the UPS to next sequence.

## INVISIBLE HINGED ZIPPER FOOT

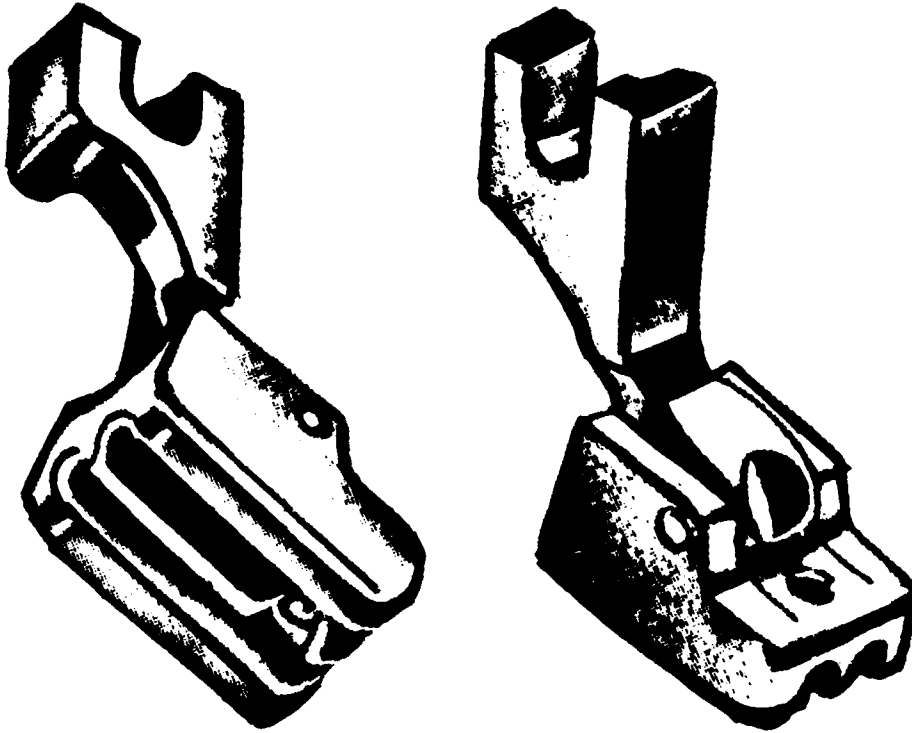

Application of an invisible zipper using special foot may be desired for style.



Position zipper into tunnel of foot and stitch.

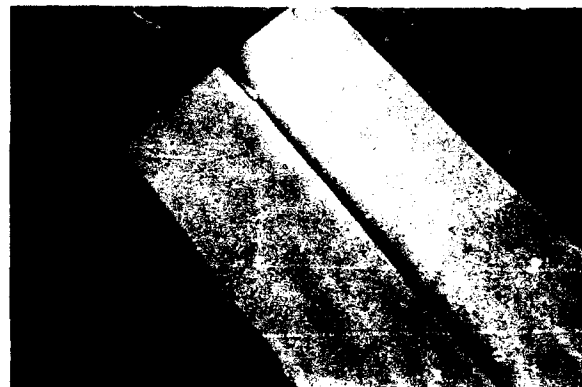

Application of invisible zipper completed.



Side back sections are attached to center back section.



As operation is completed the UPS moves skirt back section to pressing station.



Center back section of skirt is pressed. Pleats are aligned and creased at fold, then pressed.



Back section with pleats pressed.



Pleat underlay to be marked.

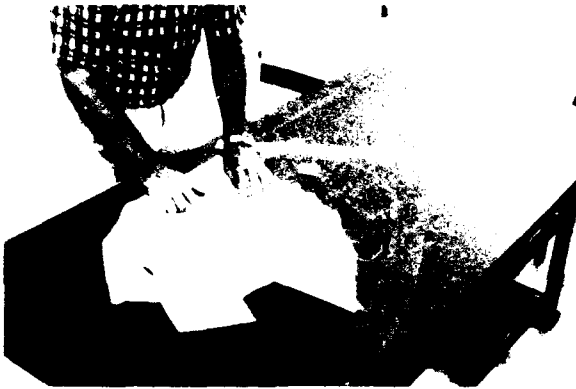

Template for pleat stitching guide placed on pleat.



Pleats are marked on face of garment.

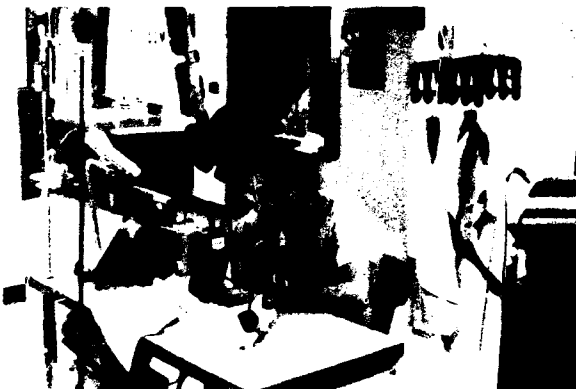

Inverted pleat and two side pleats are stitched using programmable seam length.

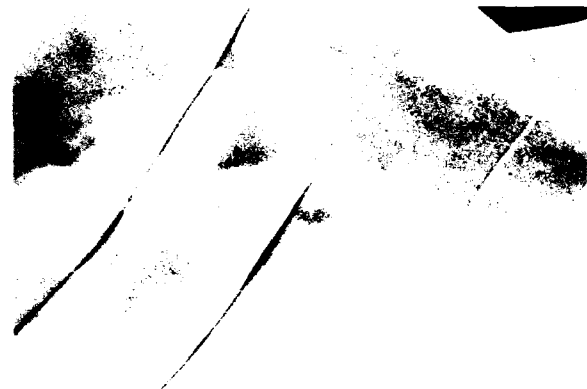

Stitch on pleat lines completed.





Completed back section of skirt.

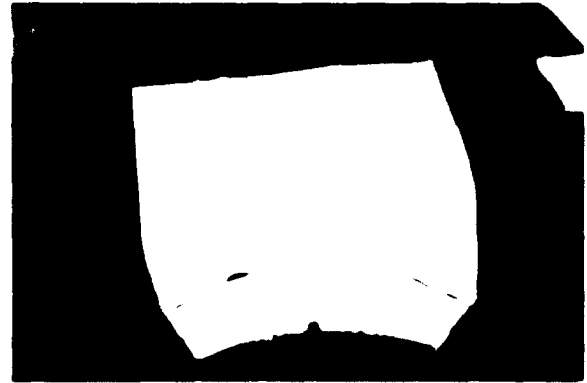

Completed front section of skirt.



Front and back section placed in UPS hanger.

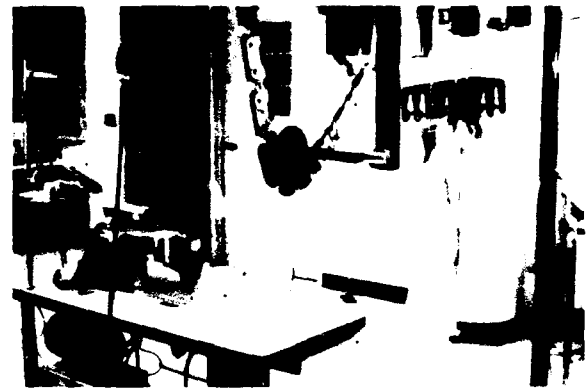

Parts are transported on the UPS.



Front and back sections are stitched together, side seams are joined.



When operation is completed the joined skirt is placed on hanger for next sequence.



Assembled skirt is placed on pressing arm.



Seams are pressed prior to next sequence.

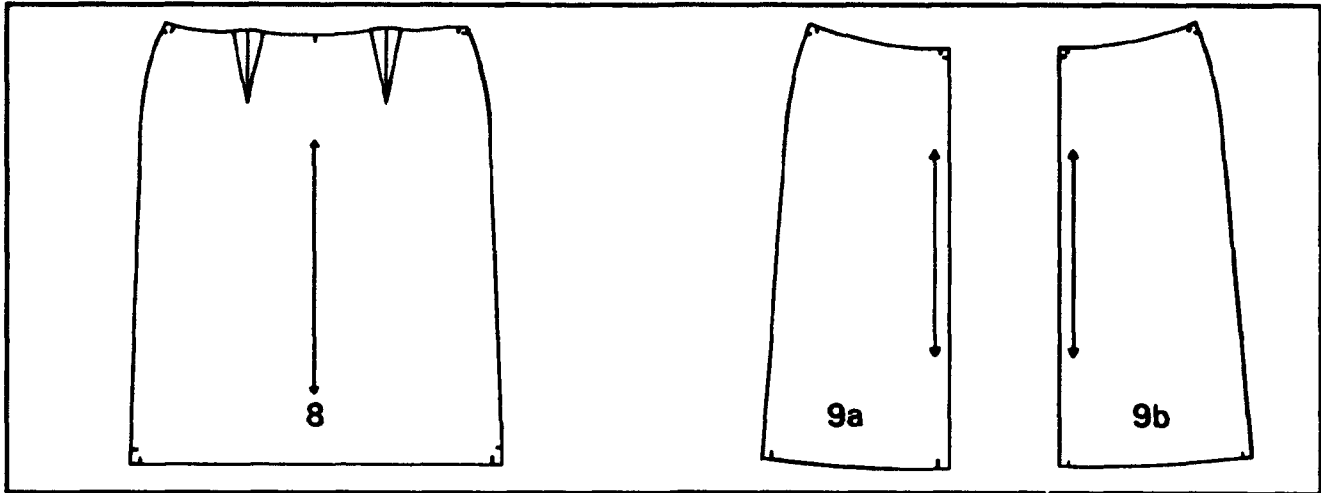

Front and back sections of lining pattern.



Automatic dart sewer programmed for length of dart, back tacking and thread cutting.



Dart edge is folded and placed in line for dart sewing operation.



Automatic sewing operation in action.



Completed operation shows sewn dart.

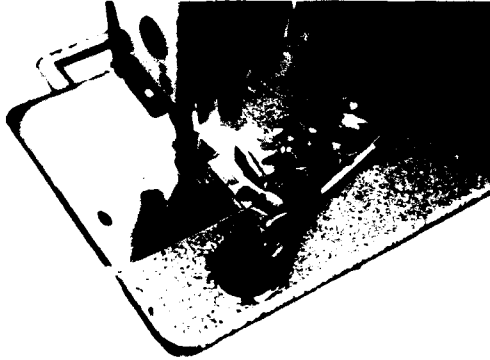

Hemming attachment to hem slit opening and lower edge of skirt lining.

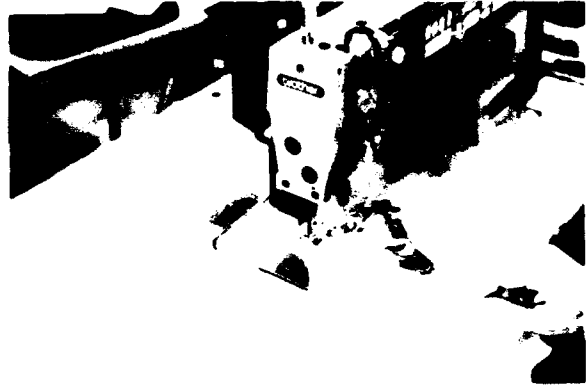

Open front end of hemmer attachment and fold over edge to be hemmed.

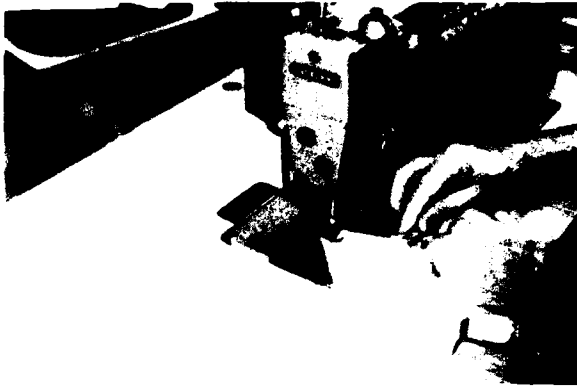

Position hemmer folder over garment part to be hemmed.

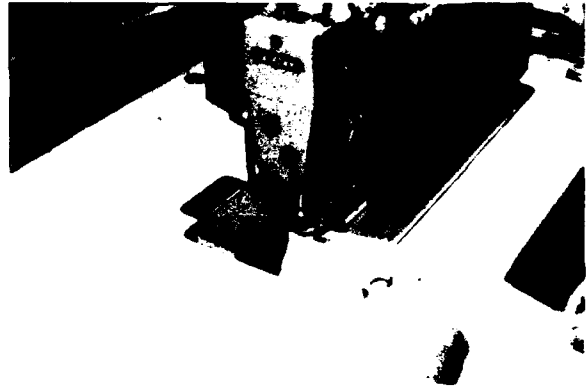

Hemming slit opening at lower edge.

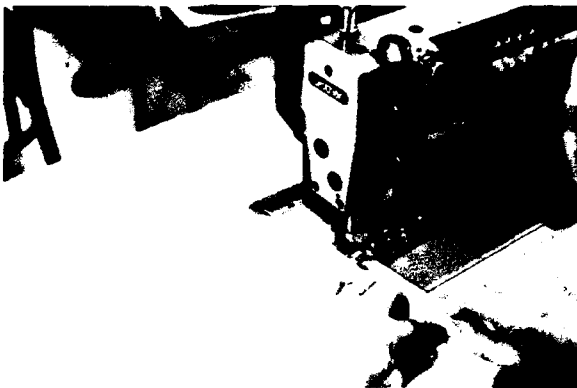

Hemming opening for zipper.



Hemming operation completed.



Serge lining pieces on a two thread overlock machine fitted with an automatic chain cutter.

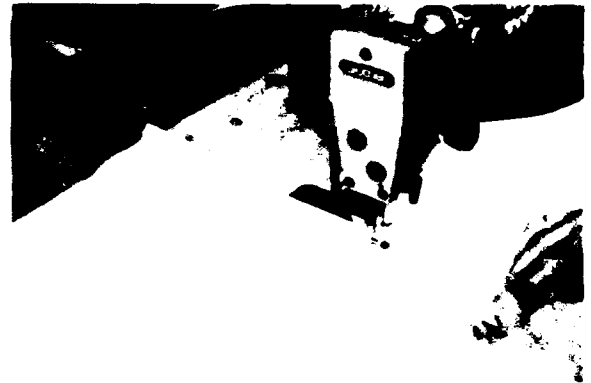

Join center back sections of lining from hemmed slit edge leaving opening for zipper.

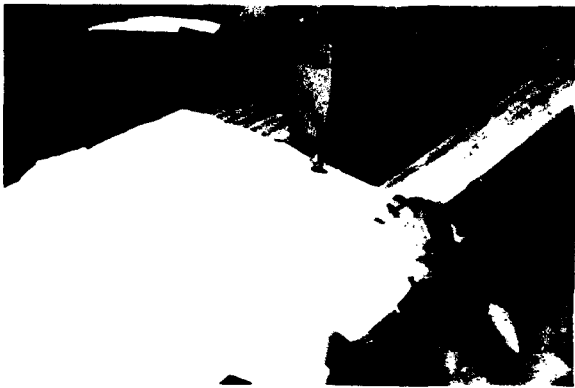

Join side seams of lining.



Press dart at waistline of lining,



Press side seams.



Press center back seam of lining.

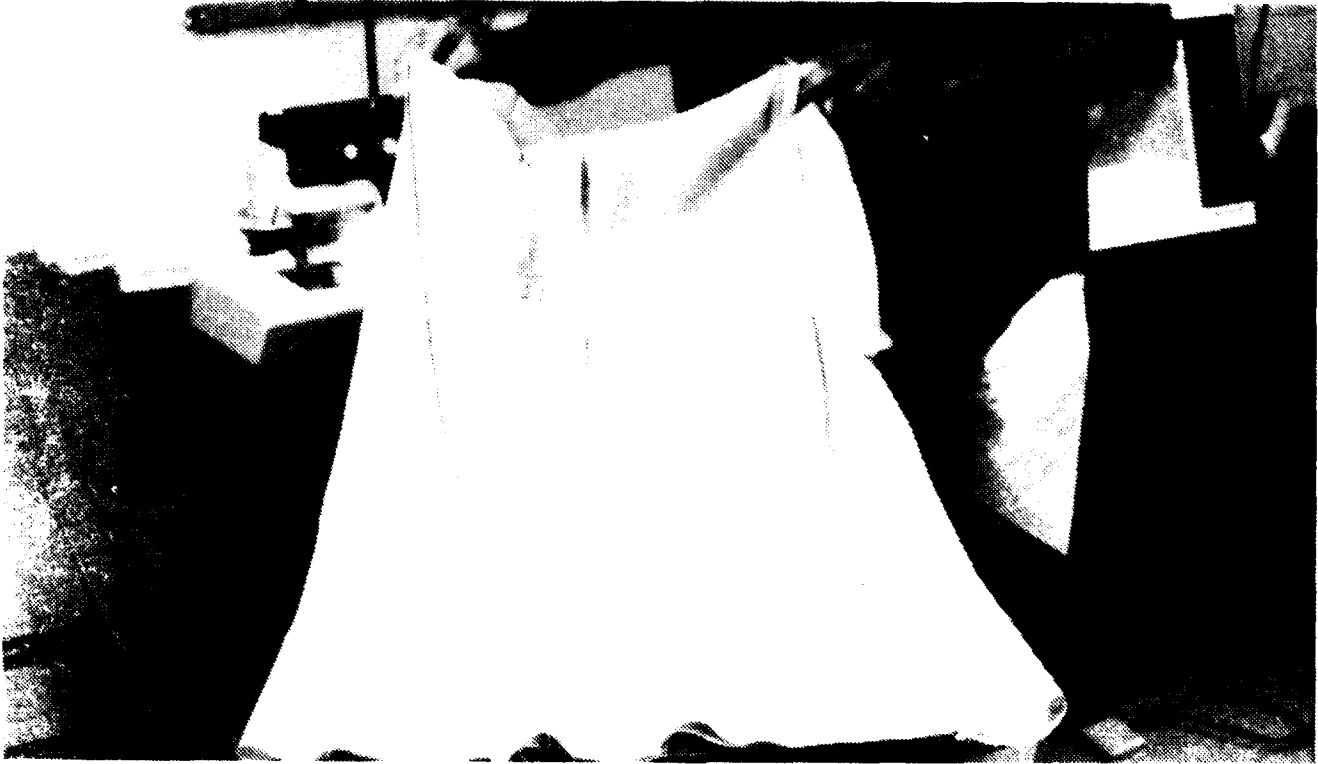

Shirt sections joined.

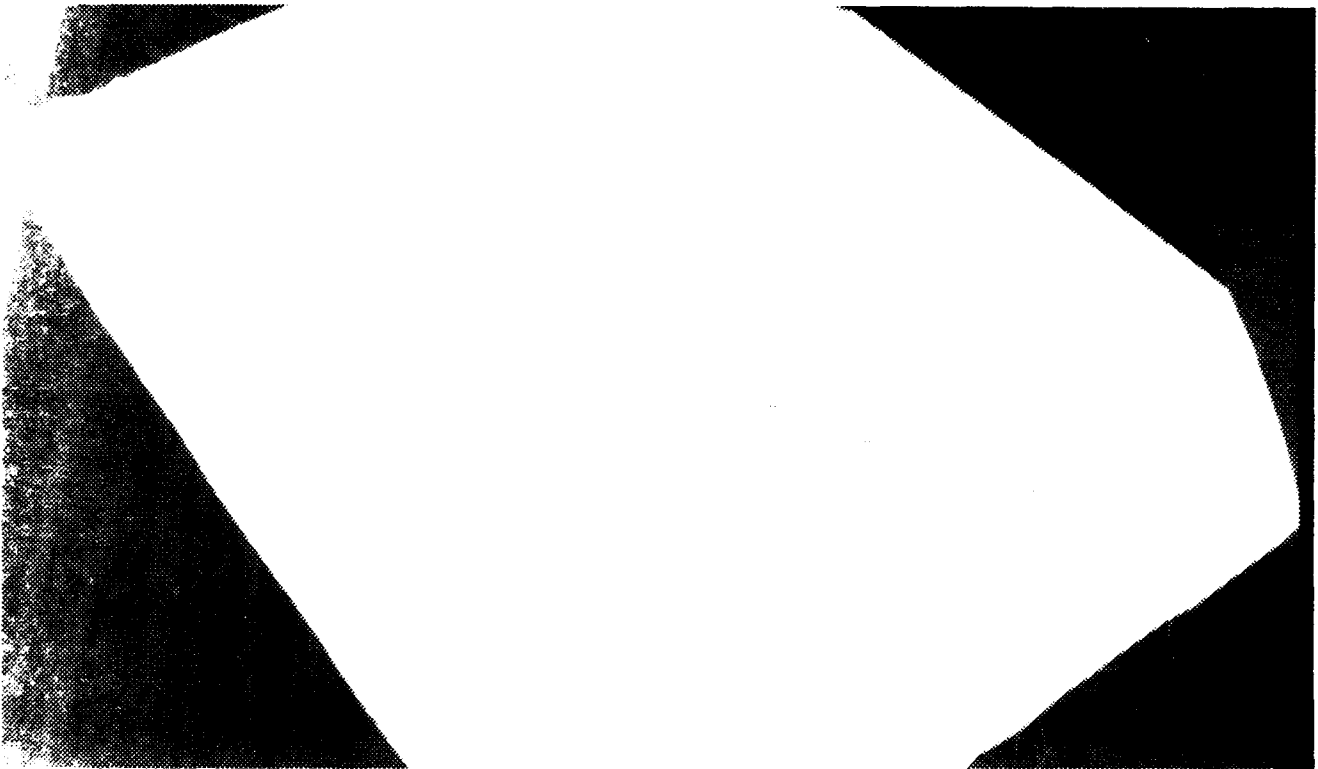

Shirt sections joined.



Skirt and lining section ready to be attached.



Lining positioned to inside of skirt with seams facing each other and matching at waistline.



Prepare skirt hanger strips.



Stitch lining to shell at waistline.



Insert hanger strips at side seams.



Skirt and lining joined, hanger strips attached.



A specific amount of elastic is cut for waistband application.



Stitch elastic to the waistband using a programmable lockstitch machine set for a four bar linear tack.

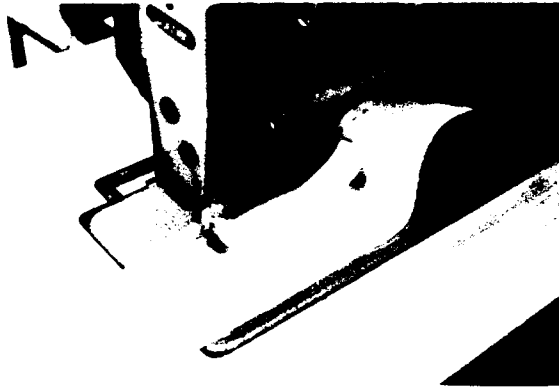

Stitch elastic on opposite sides.



Elastic applied to the left and right sides of waistband.



Match waistband seam to waistline of skirt.



Stitch waistband to skirt waistline.





Hook and eye press with a self feeding unit that also automatically inserts a backing strip.



Apply fastener to waistband prior to closing ends.



Hook and bar fastener applied to waistband.

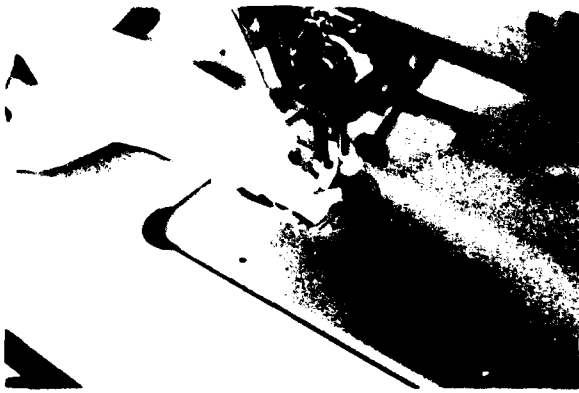

Stitch end corners of waistband.



Corner of waistband stitched.

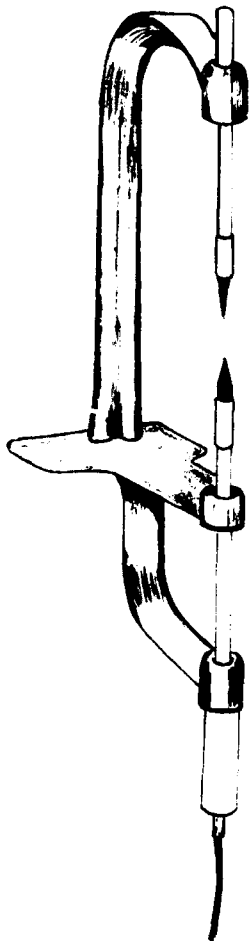

Air operated point turner for turning angled section of garment.



Position corner angle over pointer and activate automatic turner.



Corner of waistband turned.



Fold waistband on fold line and top stitch edge of seam line on face of garment.



Continue top stitch operation to complete waistband attachment.



Apply seam binding to hem edge of skirt.

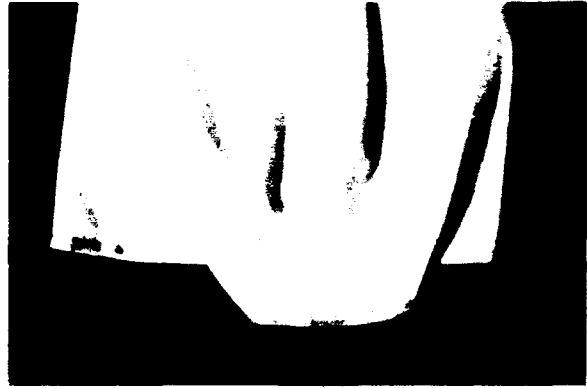

Seam binding applied.



Hemming the skirt on a blindstitch machine.

Note: Hemming operation may be completed prior to attaching lining or after all sewing operations are completed.

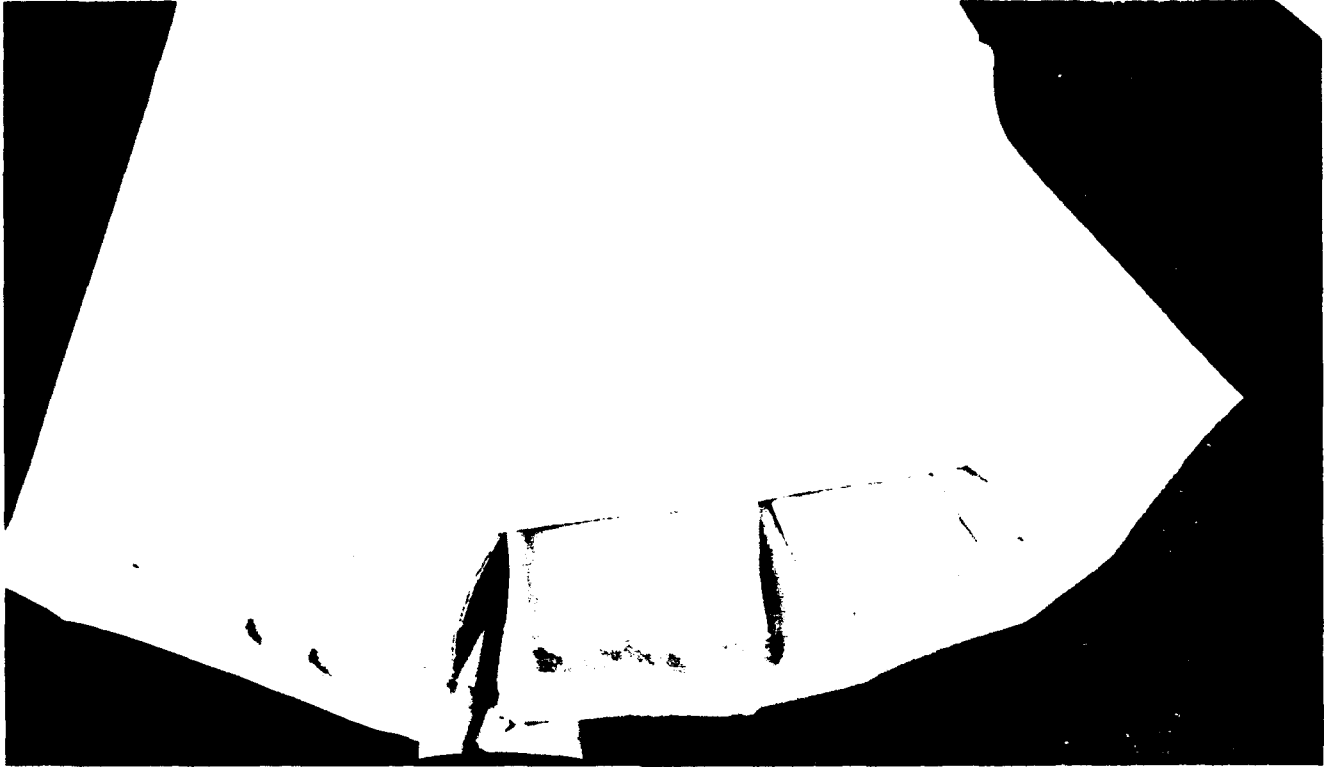

Blindstitch finished hem shown with seam tape/seam binding finished edge.

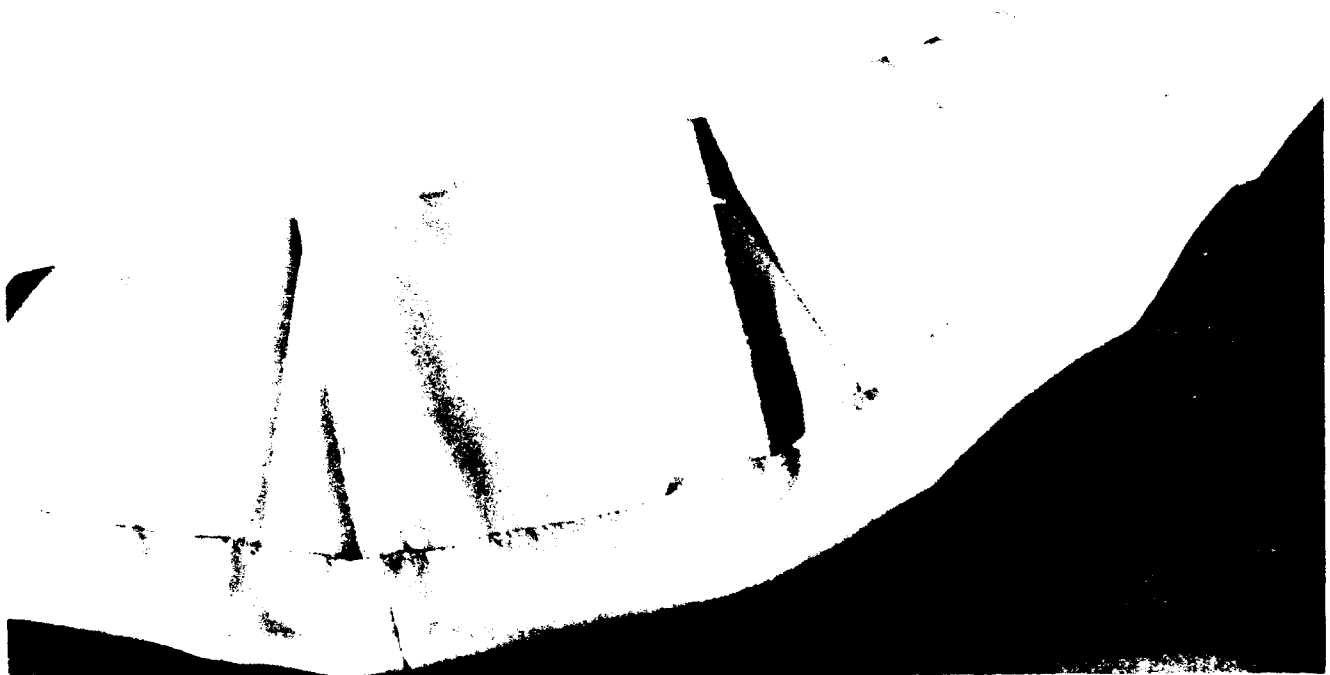

Blindstitch finished hem shown with serged finish.

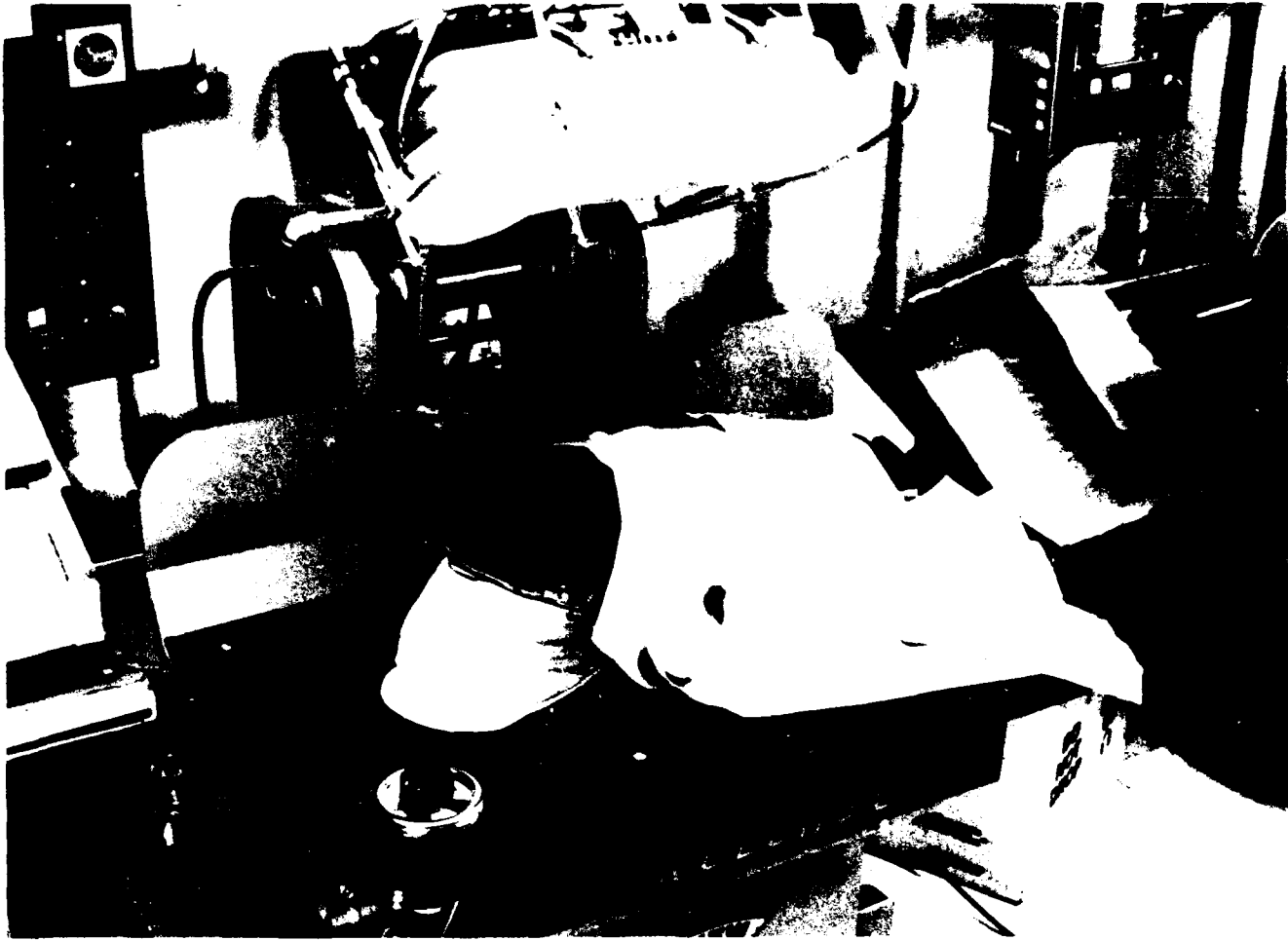

Final pressing of unit on standard pressing machines. Topper press used to press top section of skirt.

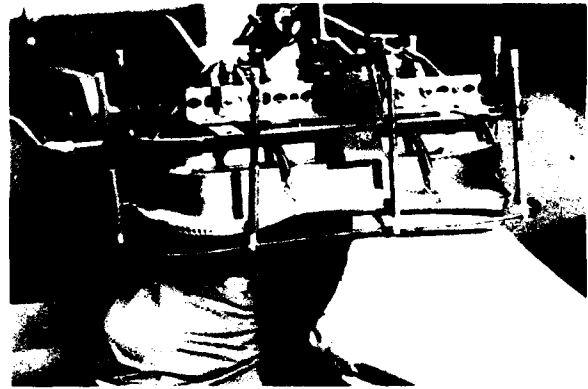
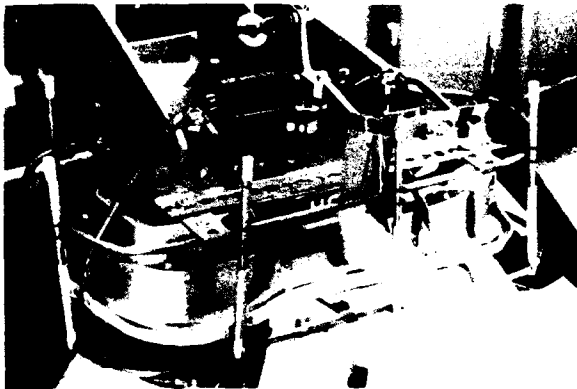

Programmable units allow one presser to operate two machines in tandem.

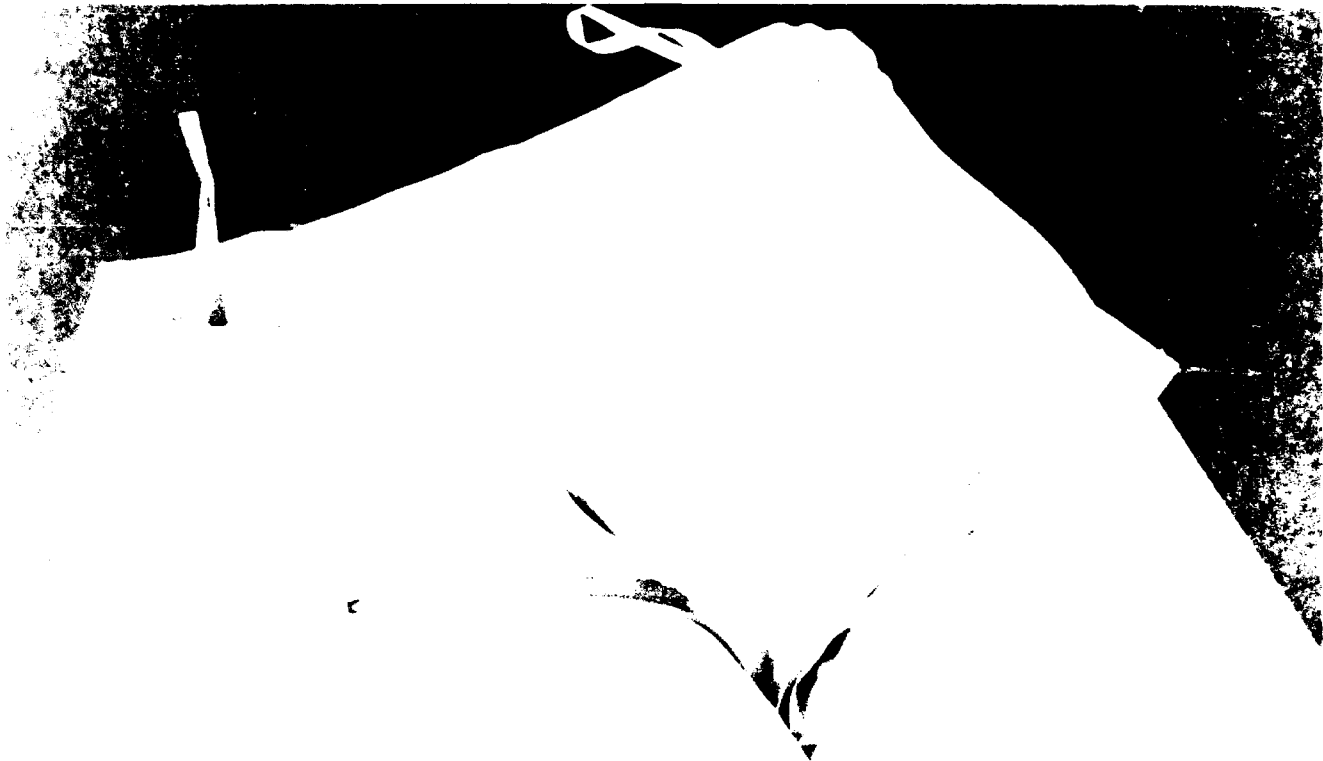

Finished skirt. Inside view.

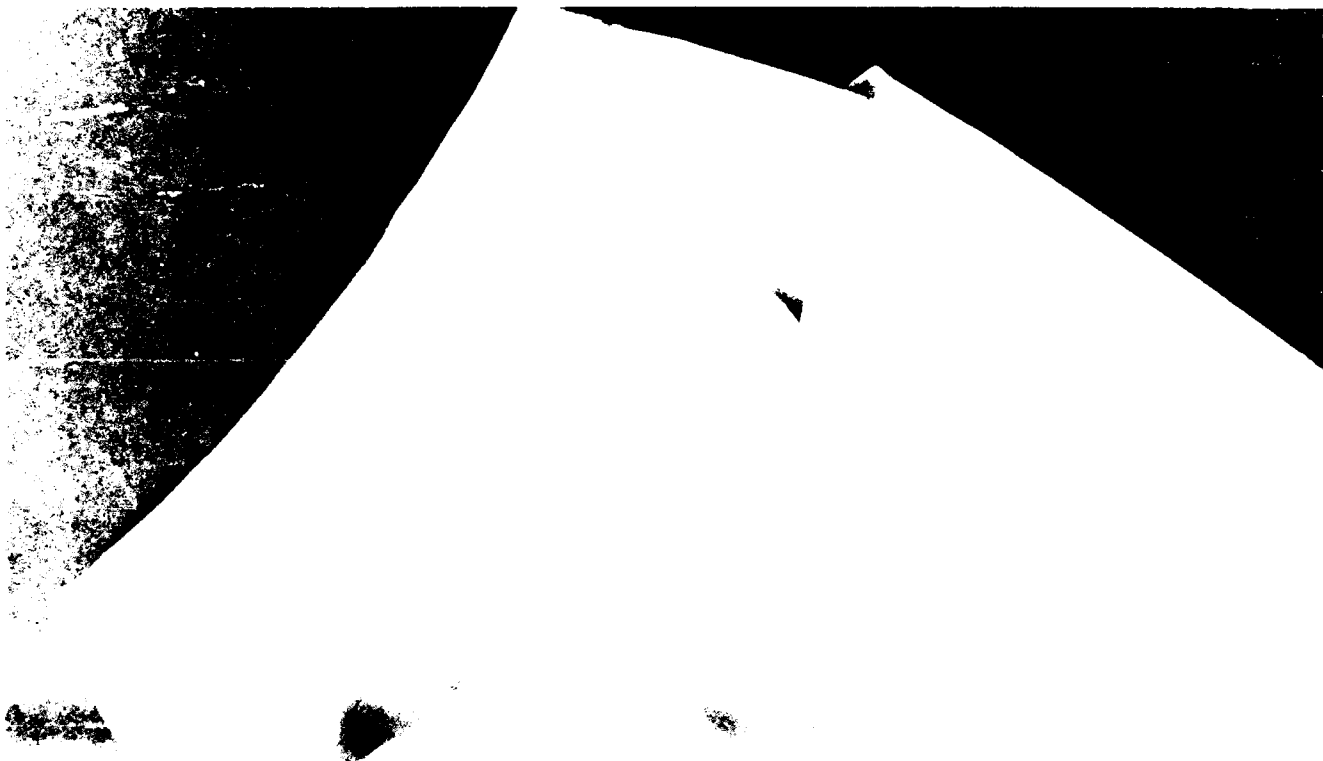

Finished skirt. Outside view.





## **CHAPTER 4**

# **CUSTOM CLOTHIER**

**A custom tailored garment is made to an individual's measurements incorporating dressmaking techniques and/or the skills of hand tailoring operations and fine detailing. A skilled seamstress, trained tailor, or couturier drafts a pattern from measurements or drapes the pattern on the individual's body. The pattern is then laid out and cut from prepared fabric, basted, fitted, sewn and finished in typically "European" traditions of fine tailoring.**

**Custom clothing is assembled singularly to the needs and specifications of an individual. Due to the nature of custom clothing, fine tailoring and specific details usually are employed in the assembling process.**

**Custom Clothier procedures allow for the most intricate assembling of the pocket and coin pocket within the details of the hip yoke. The coin pocket application within the hip yoke provides a clean finished edge within the seam of the front yoke.**

**The center back seam has a two inch seam allowance. The additional seam allowance is designed to act as a stay for the inverted pleat when stitched at the waist into the waistband of the garment.**

**The side back section seam width and shape, are designed wider so the seam allowance acts as a stay keeping the side pleat hanging straight and even when the garment is worn.**

**Developing the pattern to the size and contour of the individual assures perfect fit. Fittings during the various stages of the assembling process provide for changes that may be necessary, thereby eliminating alterations to the final garment.**

**Following is a list of equipment and tools that may be found in a Custom Clothier establishment, as well as a list showing sequence of operations that may be employed for assembling the tailored skirt. In the assembling process, the front sections or the back sections may be put together first.**

**EQUIPMENT AND TOOLS FOUND IN A CUSTOM CLOTHIER ESTABLISHMENT:****Cutting equipment**

- shears
- electric scissors
- cutting machine

**Machines**

- lockstitch sewing machine
- overedge machine
- computer programmable machine with variable sewing functions

**Pressing equipment**

- automatic wide bed press
- pressing table
- ironing board
- steam iron
- gravity fed steam iron
- sleeve board
- seam roll
- clapper
- point turner
- ham
- pressing mitt
- assorted pressing cloths

**Tools**

- hem marker

**SEQUENCE OF OPERATIONS TO DEVELOP AND ASSEMBLE A GARMENT IN CUSTOM CLOTHIER ENVIRONMENT:****I PREPARATION:**

- Measure individual
- Draft or drape pattern
- Fit pattern
- Shrink fabric/press fabric
- Lay out pattern pieces
- Cut out pattern pieces
- Mark seams and notches

**II ASSEMBLE:****Front:**

Overedge coin pocket on three sides  
Attach coin pocket to lining section  
Clip and press  
Interfacing to pocket fold  
Pocket lining to lower edge of side panel  
Press  
Attach pockets to yoke section  
Press  
Attach lower edge of side panel to yoke section  
Sew pocket edges  
Tack pocket fold to yoke  
Overedge seams  
Press  
Overedge seams of center front section  
Join side front sections to center front section  
Press

**Back:**

Overedge sections  
Join center back pieces  
Insert underlay of pleat  
Press  
Insert zipper  
Join center back section to side back sections  
Press  
Mark pleats  
Top stitch pleats

**III ASSEMBLE AND FIT:**

Join side seams of front and back sections  
Fit skirt to individual  
Adjust ease at waistline

**IV WAISTBAND PREPARATION:**

Apply interfacing to waistband  
Press  
Finish lower edge of waistband

**V ASSEMBLE LINING:**

- Sew darts
- Sew center back seam
- Sew side seams
- Overedge seams
- Hem slit opening
- Hem lower edge
- Press

**VI FITTING:**

- Fit finished lining to finished skirt
- Fit waistband to fitted skirt on individual
- Fit elastic to waistband

**VII ASSEMBLE WAISTBAND:**

- Sew waistband to skirt
- Apply hanger loops
- Sew edges closed
- Turn edges
- Crack stitch waistband
- Press
- Apply closure

**VIII HEMMING AND FINISHING:**

- Fit on individuals
- Measure hemline length
- Apply seam tape
- Slip stitch hem by hand
- Clip seam at pleat
- Stitch pleat seam in hem area
- Attach lining to shell at hem line

**IX PRESSING****X FINAL FITTING****XI FINAL PRESSING**



To prepare for measuring, client wears a specially designed body suit.



Take measurement at waist.



Take measurement at abdomen/high hip level.



Take measurement at hip level.



Take measurement at low hip level.



Take length measurement at center front, and/or center back.



Record measurements on measurement chart or individual's profile chart.



Sketch of garment to be made.

CLIENT PROFILE CHART	MEASUREMENTS
Date:	Waist:
Name:	High hip/abdomen:
Fabric:	Hip:
Lining:	Low hip:
Interfacing:	Length:
Findings:	Details:

Measurement/profile chart for record keeping.



Drafting the pattern from measurements. Preparation of paper and squaring lines to establish top and bottom of garment.



Transferring measurements to paper for width and length of pattern draft.



Developing darts for shape and fit, or develop placement for style ease.



Add design and style details and finish draft of skirt pattern.

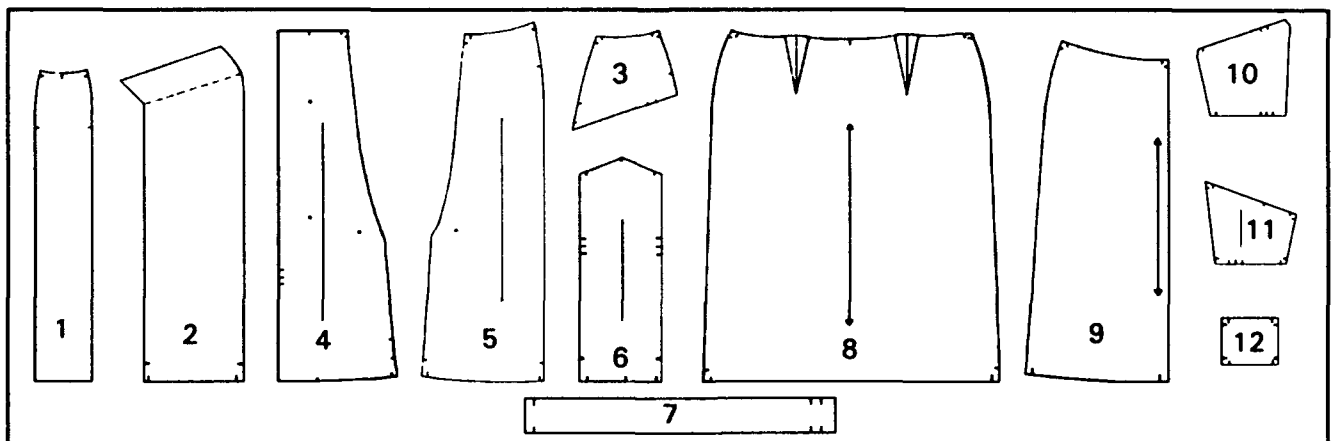

Pattern pieces of skirt: (1) Center front section; (2) Side front section; (4) Center back section; (5) Side back section; (3) Front yoke section; (6) Pleat underlay; (7) Waistband; (8) Front lining section; (9) Back lining section; (10) Pocket lining; (11) Pocket facing; (12) Coin pocket.



Developing the pattern by draping. Fit muslin to center front and drape center front section.



Fit muslin to side front and develop side front section.



Fit muslin to side back and center back and develop sections.



Mark muslin sections at seam lines and style lines on front and back of skirt.



Fit waistband to trued skirt.

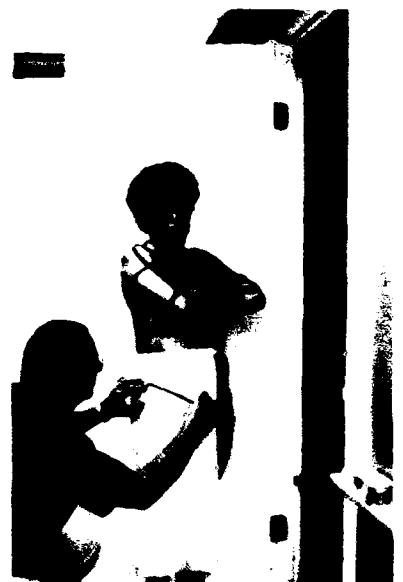

Establish style detail lines for hip yoke and pocket.



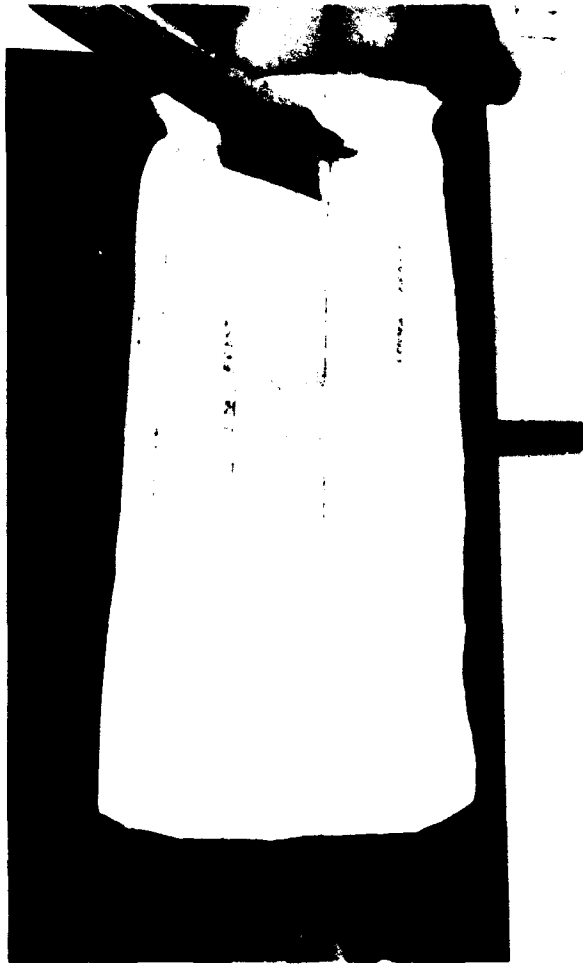

Front pocket detail and hip yoke section developed. Back inverted pleat and side pleats developed.

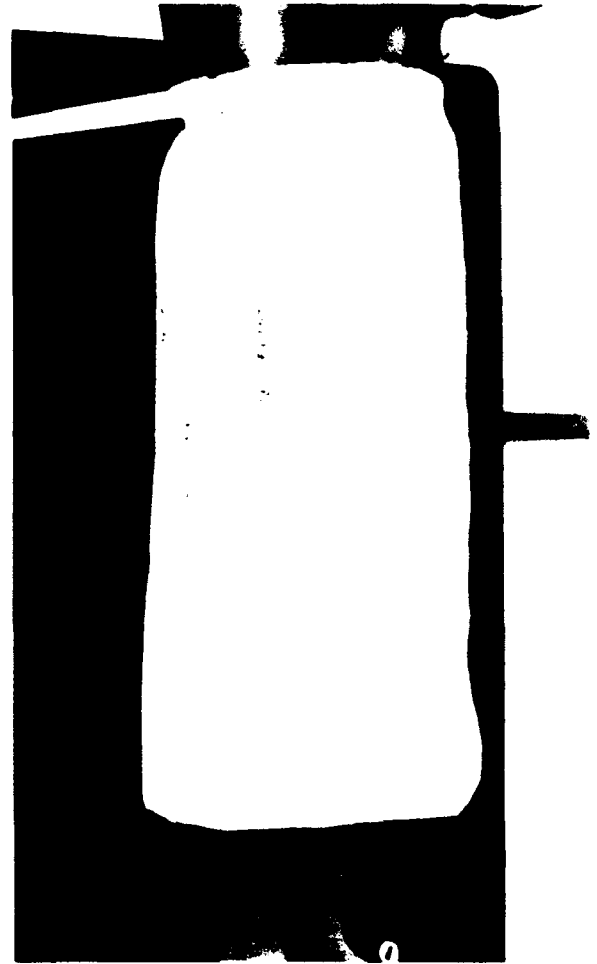

Final fitting of muslin skirt and final fitting of waistband.



Sponging and shrinking fabric using pressing cloth dipped in water.



Wet press cloth spread over fabric and steamed until dry. Process continues for yardage needed for skirt.



Final pressing of shell fabric.



Pressing of lining fabric.



Placing center front pattern section to fold of fabric.

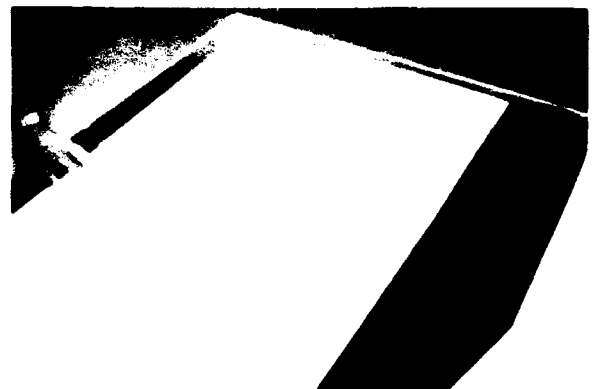

Placing and chalking all pattern pieces on fabric in preparation for cutting.



Measuring grain line for lining pattern placement.



Placing all lining pattern pieces on lining fabric for cutting.



Preparing and cutting pocket fold interfacing.



Interfacing placed to fold line of pocket.



Fusible interfacing section pressed in place.



Lower side section of pattern and pocket facing pieces.



Pocket facing piece placed and pinned to lower side section.



Pocket facing stitched to section.



Pocket facing stitched to edge of lower side front panel.



Press seams flat.



Fold pocket underlay on fold line.



Press pocket fold in place.

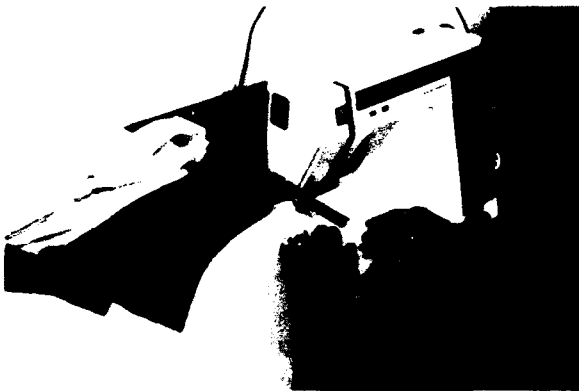

Top stitch at fold line of pocket edge.



Inside view and face view show pocket sections completed.

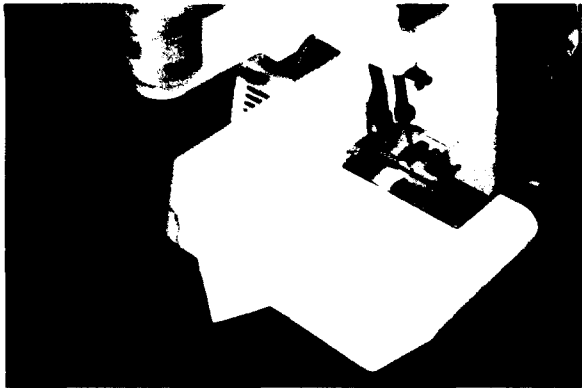

Overedge coin pocket pattern piece around three edges.

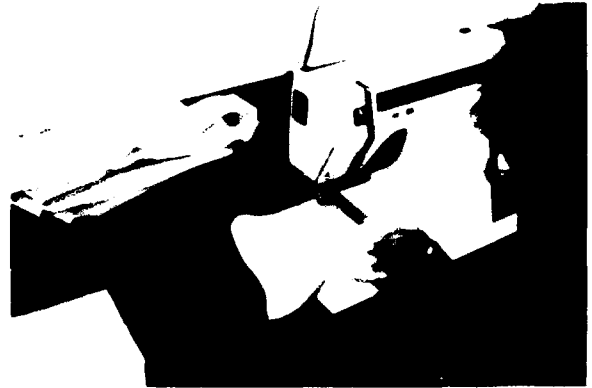

Overedge upper edge of pocket lining section.

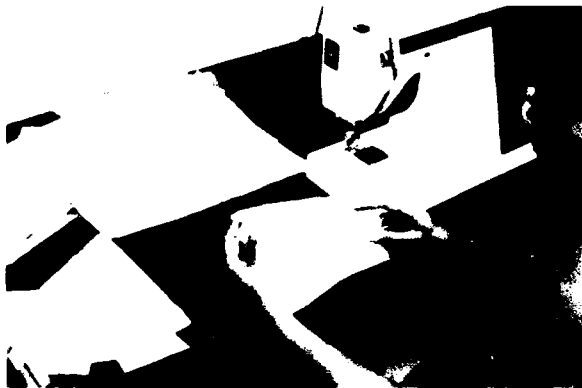

Position coin pocket to upper edge of pocket lining.



Stitch coin pocket in place.



Clip at notch points of upper edge of pocket to release coin pocket seam.



Notches clipped and coin pocket ready to be under pressed.



Under pressing seams of coin pocket and pocket lining.



Pin yoke section (shell fabric) to pocket lining at coin pocket edge.



Stitch seam from edge to notch, skipping coin pocket, and from notch to edge.



Seam stitched.



Front view of yoke showing coin pocket opening within the seam of yoke section and pocket lining.



Front view of section pressed and ready for next sequence.

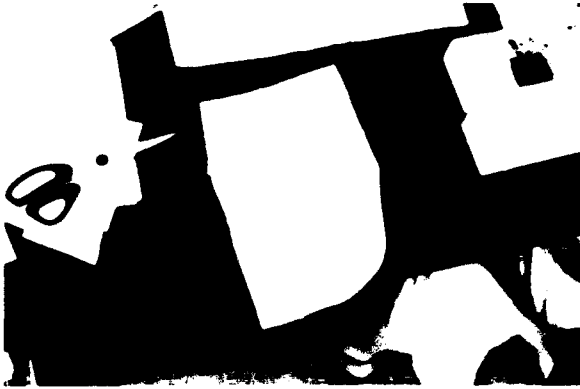

Yoke section and pocket lining sections for opposite side of skirt stitched.



Under pressing of yoke and pocket sections.



Lower side front section of skirt and yoke with pocket sections.

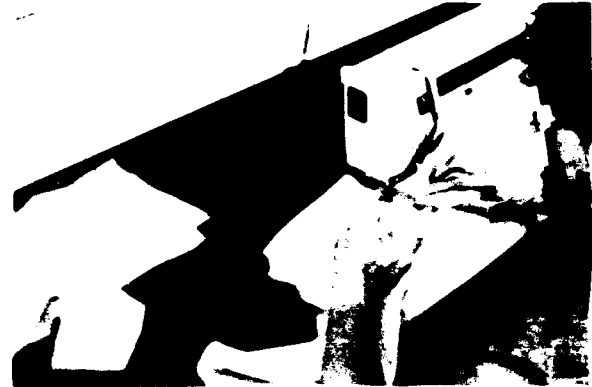

Attaching yoke section to lower side front section.



Inside view showing sections attached.

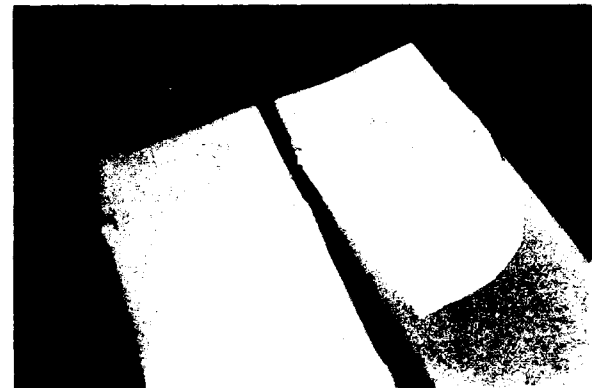

Inside and outside views of both sections of side panel attached to yoke section.



Overedge pocket section seams.

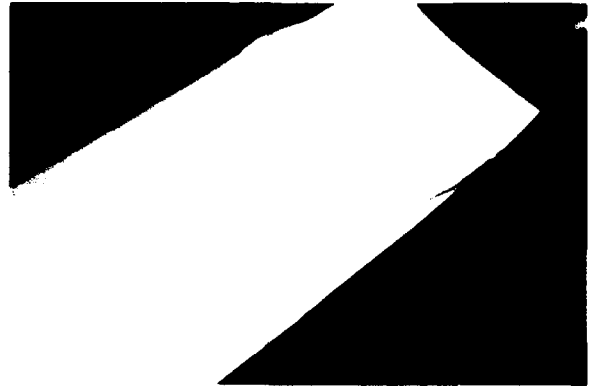

Pocket section overedged.



Underpress section.

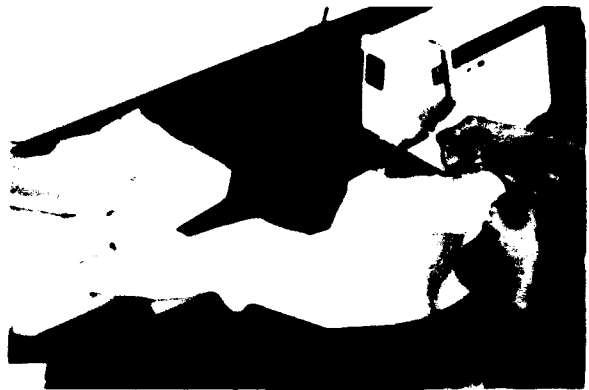

Tack/stitch pocket fold to skirt yoke to avoid shifting during next operation.



Overedge seams of side front sections.



Overedge center front section seams.





Match, pin and stitch center front section to side front section.



Press seam of section.



Press other seam. Press seams in closed position first.



Place seam over seam roll and press open.



Steam and pound to set seam.



Final pressing of seams for front section.



View of skirt front. Center front section attached to side front sections.



Skirt front completed and ready to be assembled to skirt back when completed.

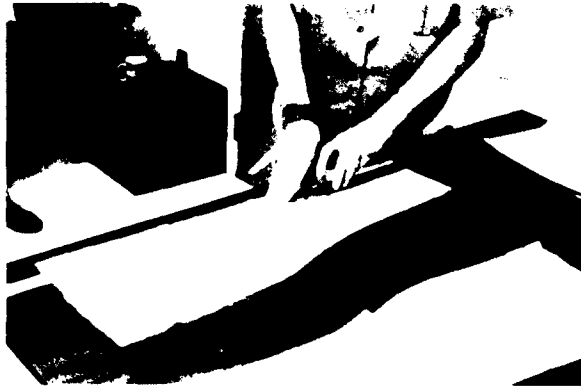

Prepare back section by chalking center back seam lines.

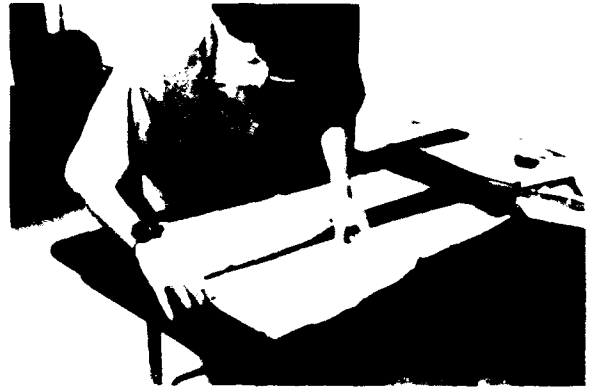

Chalk sewing line for side pleat sections.



Stitch center back line between notches.



Center back sections stitched leaving openings for inverted pleat and zipper insertion.



Attaching inverted pleat underlay to center back seams.



Top edge of underlay section stitching completed.



Inverted pleat underlay section stitched in place.

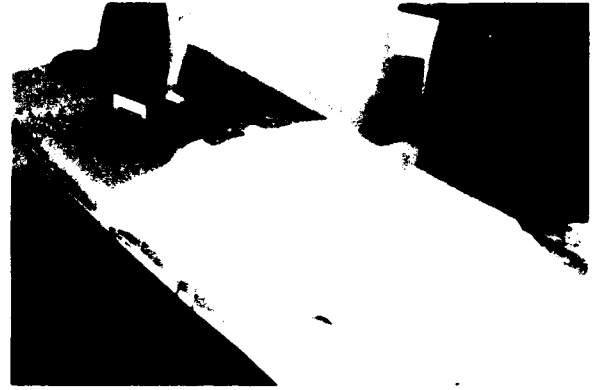

Prepare inverted pleat for pressing.

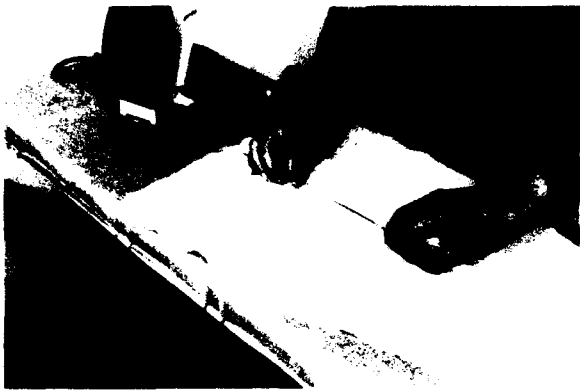

Bring folds of pleat to center of underlay.



Lower section of pleat pinned to board to secure pressing of pleat fold.

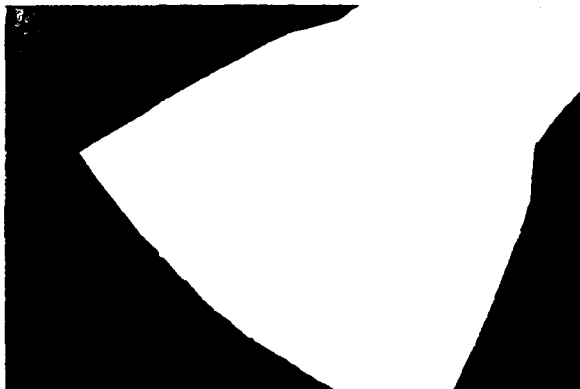

Pleat underlay pressed.

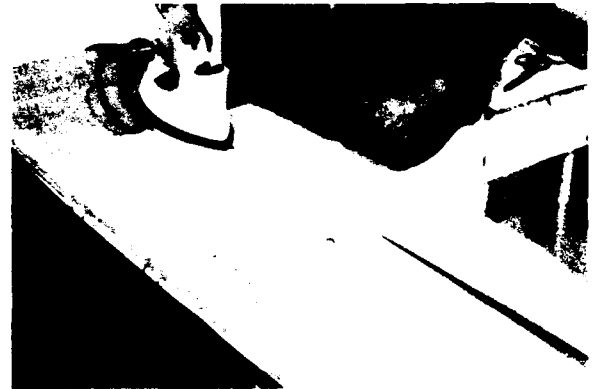

Press zipper seam opening in preparation for insertion of zipper.

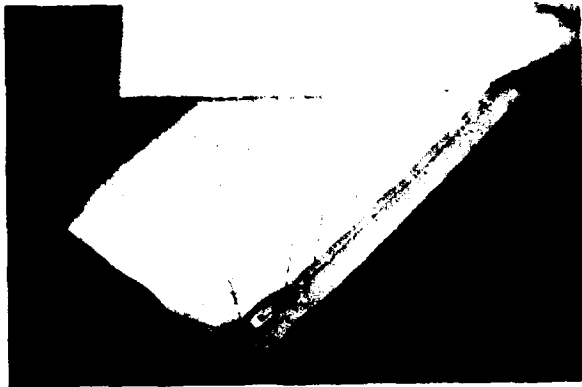

**LAP ZIPPER APPLICATION.** Position and pin zipper slightly away from center back line.



Using zipper foot, stitch zipper in place.

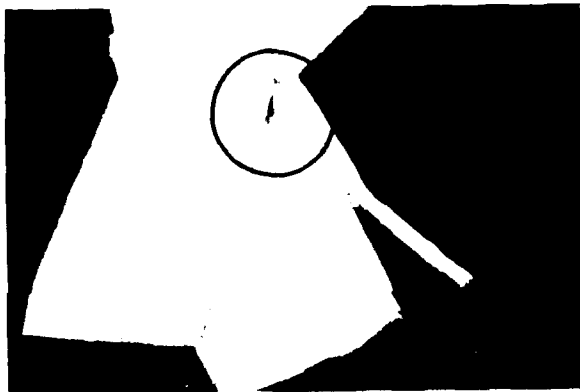

Note placement. This part of zipper is away from center back seam. Application forms underlay to conceal zipper.



Fold and pin center back seam of lap section to center back of opposite section.



Stitch zipper across bottom of lapped section.

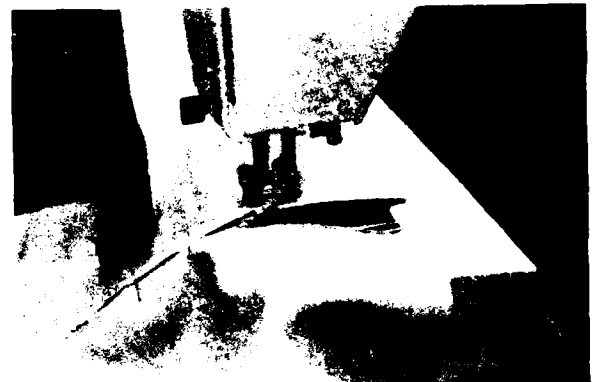

Continue stitching zipper up to end of closure, moving slide top to complete operation.



Lap zipper application completed.

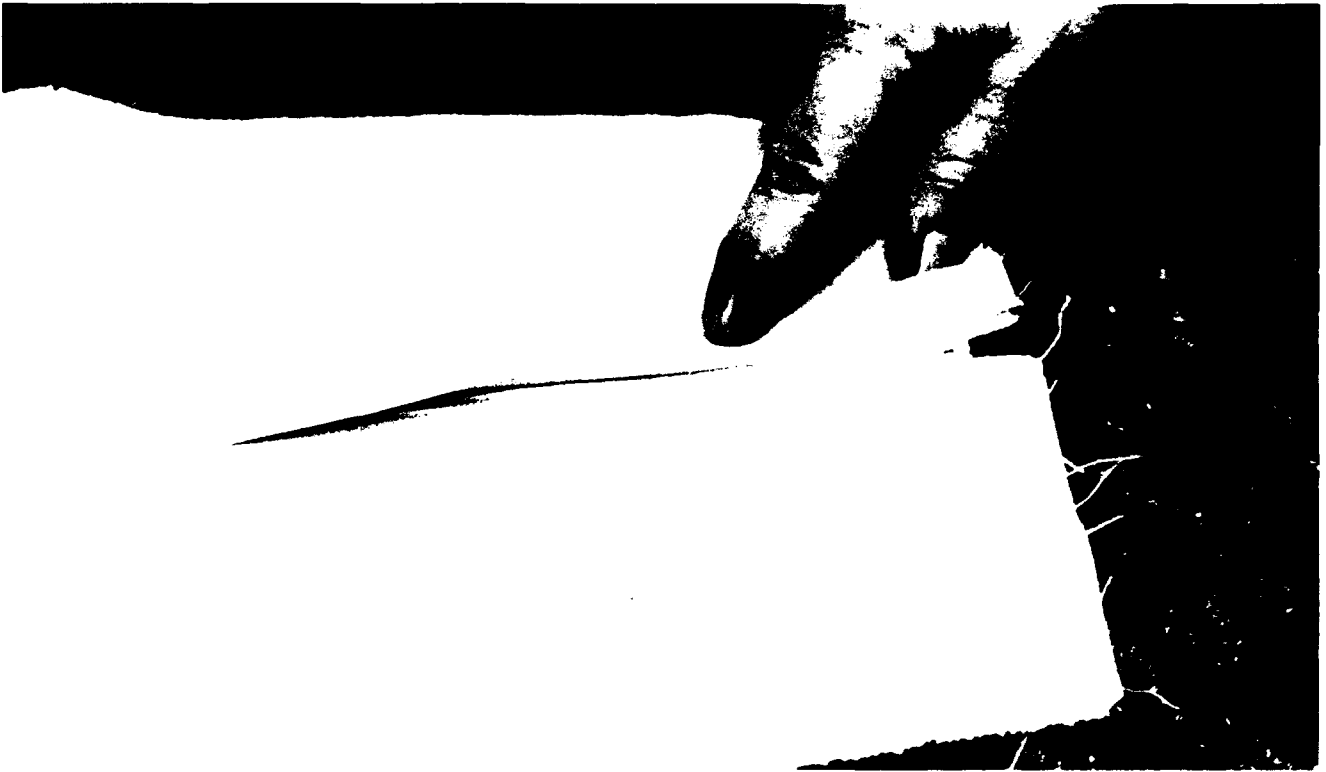

Lap section of zipper held open to show concealed zipper.

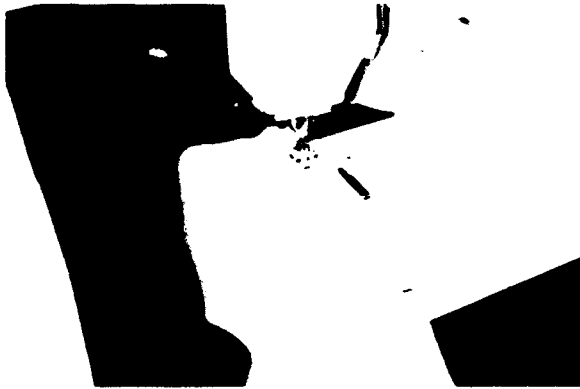

**INVISIBLE ZIPPER APPLICATION.** Use invisible zipper foot and apply zipper to one side of center back seam line.



**Apply zipper to opposite side of center back seam line.**

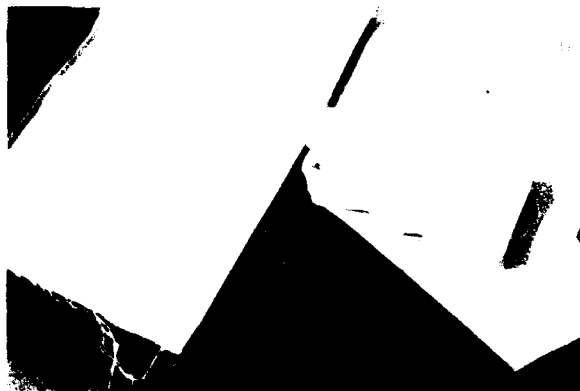

**Both sides of zipper machine stitched in place.**



**Lower edge of center back section stitched together.**



**Invisible zipper viewed in open position on face of garment.**

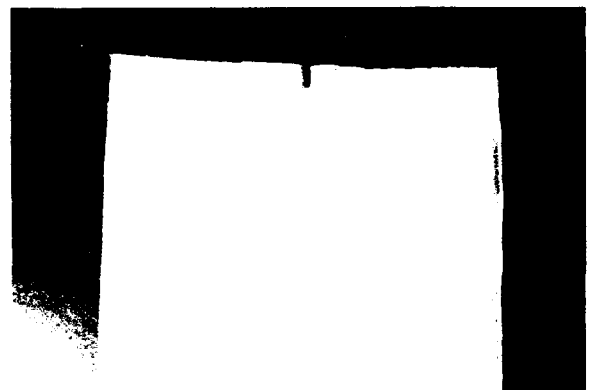

**Invisible zipper inserted in garment viewed in zipped (closed) position.**



**CENTERED ZIPPER APPLICATION.** Position zipper teeth in center of open seam and stitch along one side.



Stitch across bottom. Match center back seam to form centered seam and stitch along opposite side.



Centered zipper application inside view.

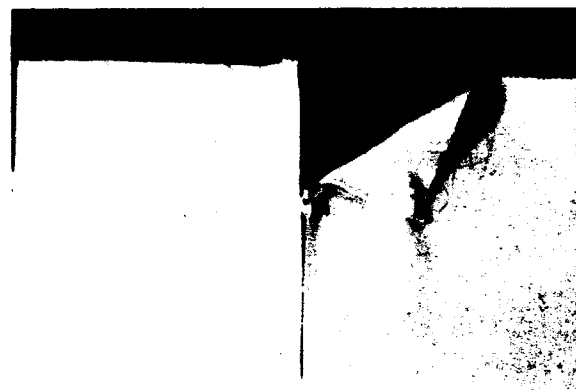

Centered zipper opened to show position of stitching on inside.



Face view of completed center zipper application.

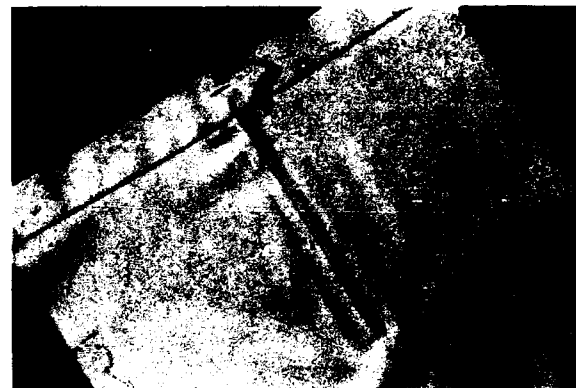

Centered zipper application viewed with waistband attached.





Position and pin side back sections to completed center back section.



Stitch together following chalked guide lines to form side pleat.



Seams of back panels stitched and completed for next sequence.



Press side pleats in place.



Using template, chalk mark stitch line for pleats on face of garment.

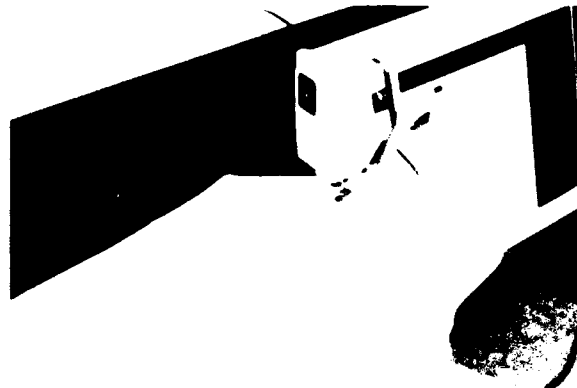

Following chalk line, stitch through all layers of fabric to secure pleats.

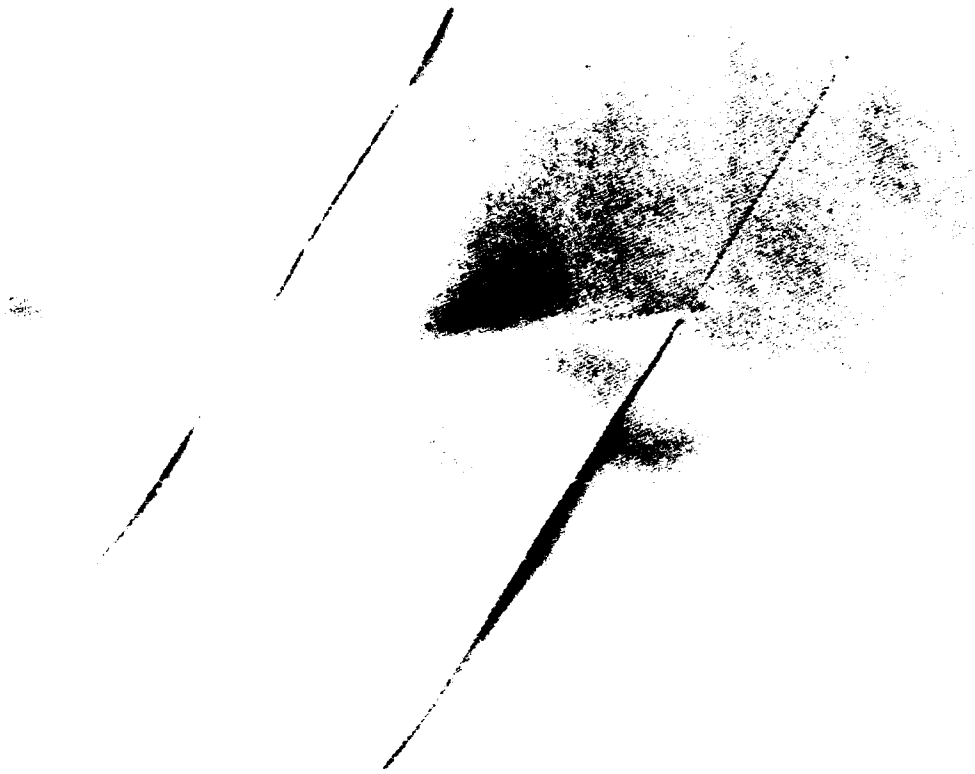

Pleats stitched in place.

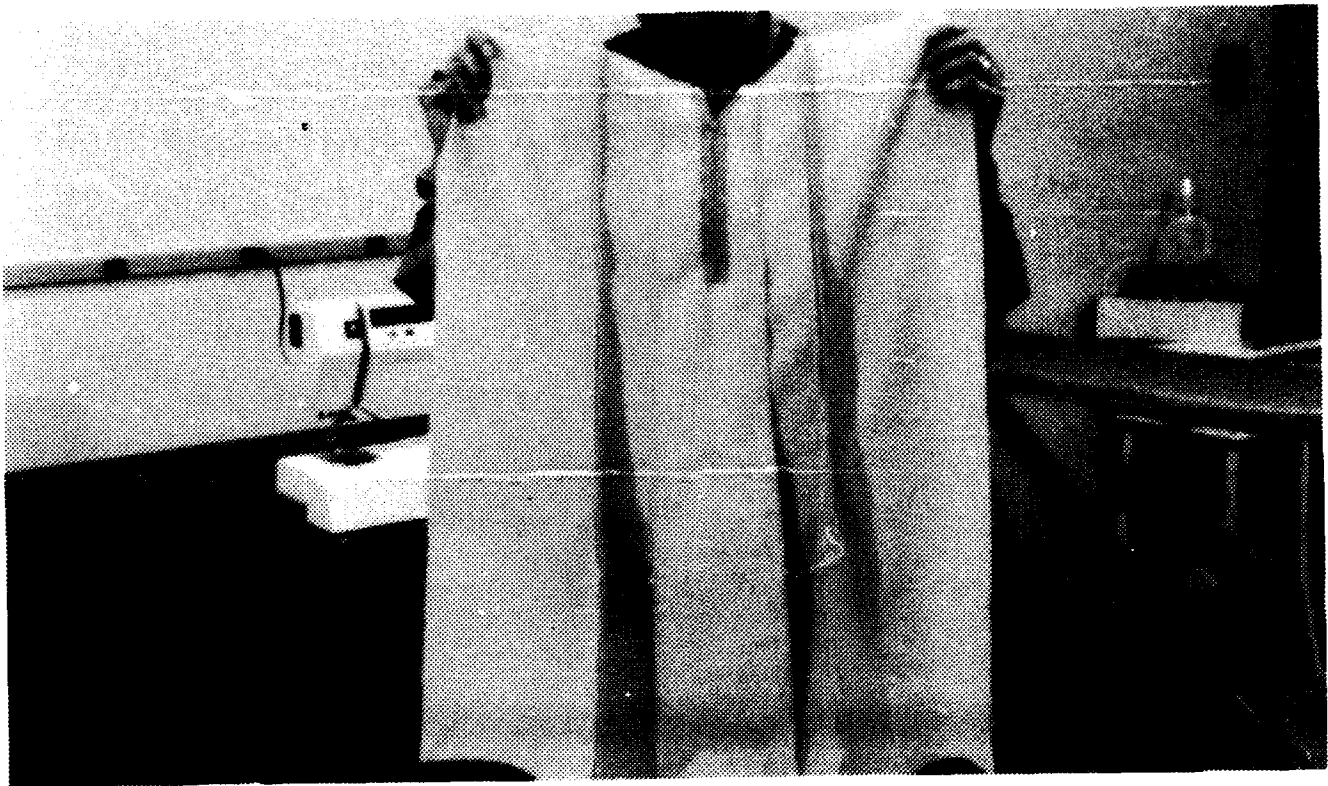

Back section of skirt fully assembled.

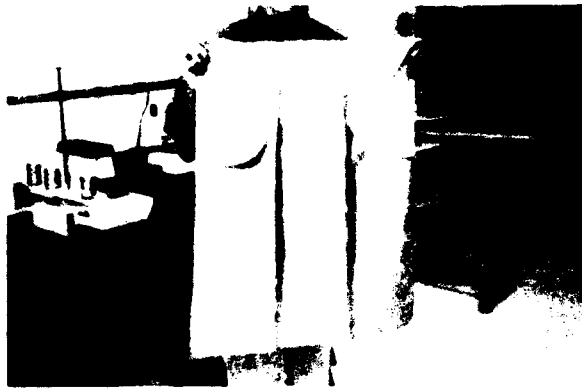

Front section of skirt fully assembled.

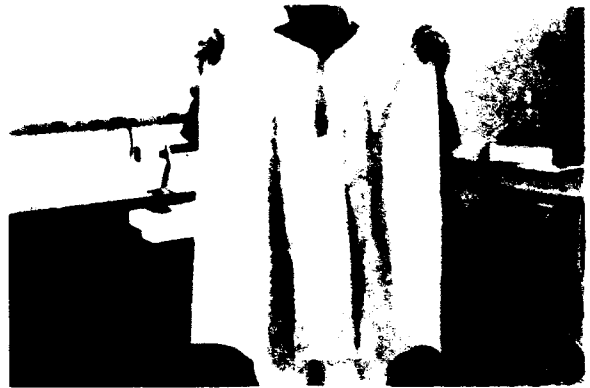

Back section of skirt fully assembled.

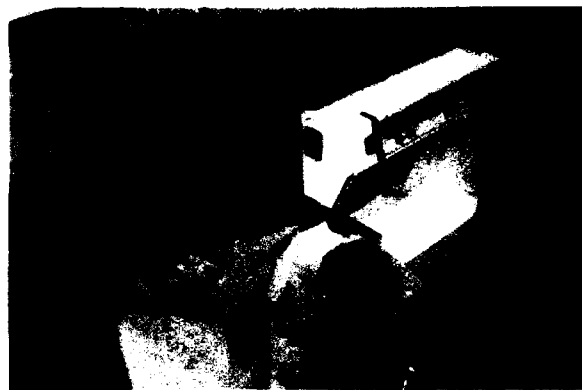

Match front and back side seams of skirt and stitch.



Trim threads from stitched seams.



Place side seams of skirt over seam roll and press open using pounder to set seams.



Front and back of skirt fully assembled and ready for fitting.



Place assembled skirt on individual and check fit at waistline.



Examine hang of seams at side front and side seams.



Examine hang of seam at side back.



Check position of center back sections and hang of inverted pleat.



Check fit of hip yoke and pocket insert.



Overedge seams of lining sections.



Match center back seams of lining.



Stitch center back seam between notches allowing for zipper and slit openings.



Press center back seam of lining.



Clean finish by hemming slit opening at center back seam.



Match front and back of lining together at side seams and stitch.

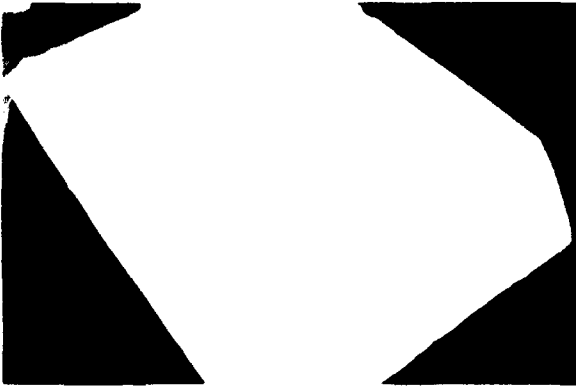

Lining completely assembled and ready for next sequence.

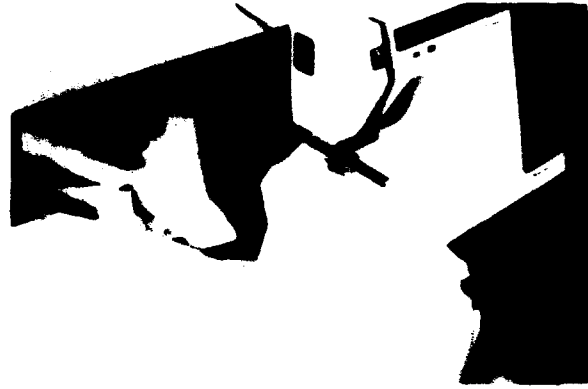

Hem lower edge of lining. Length is determined by finished length of skirt.

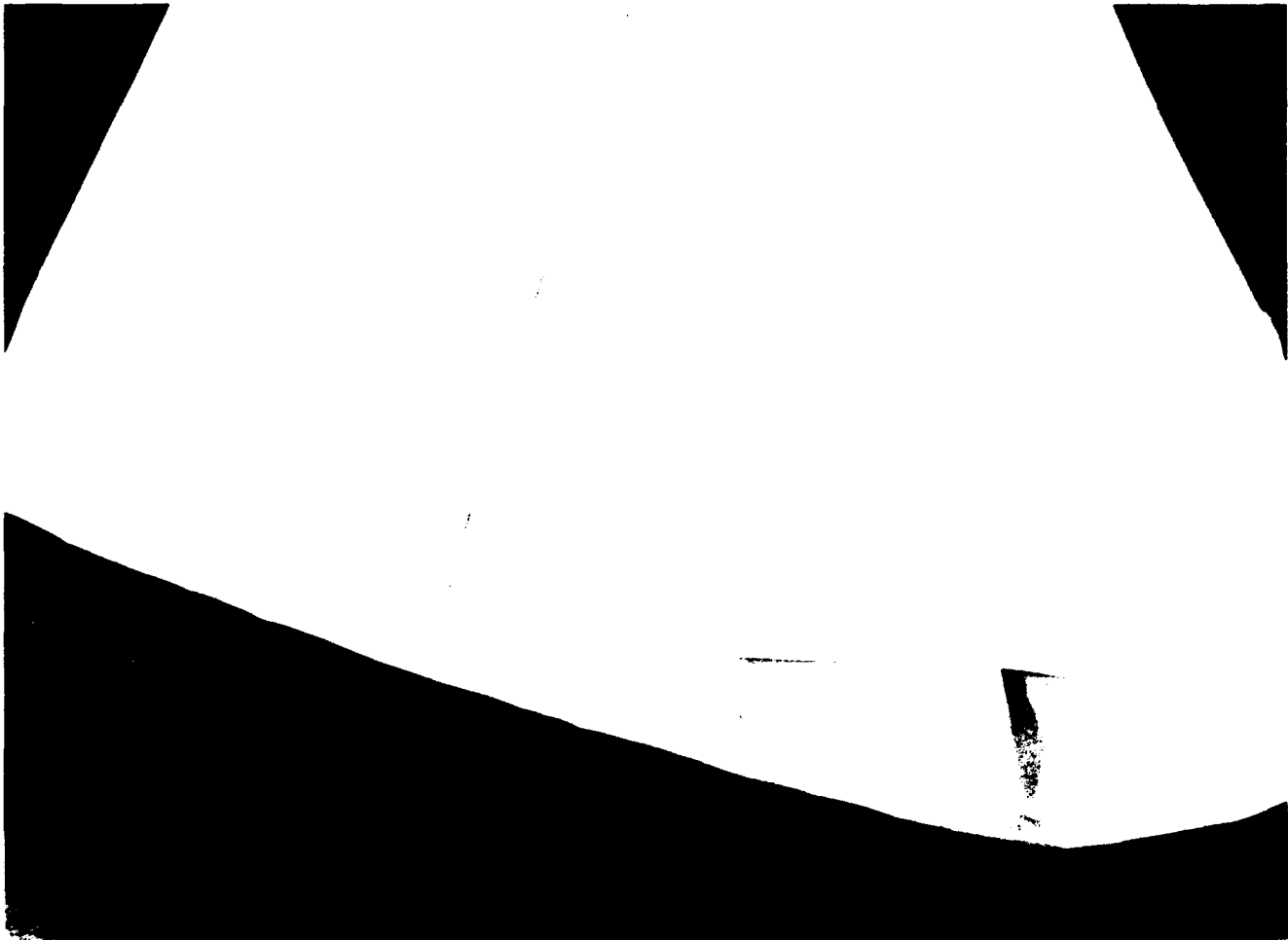

Lining of skirt complete with hem and pressed ready to be attached to finished skirt prior to waistband application.



Finished skirt and finished lining.



Match lining and skirt at waist seam area and stitch together.



Skirt and lining attached.

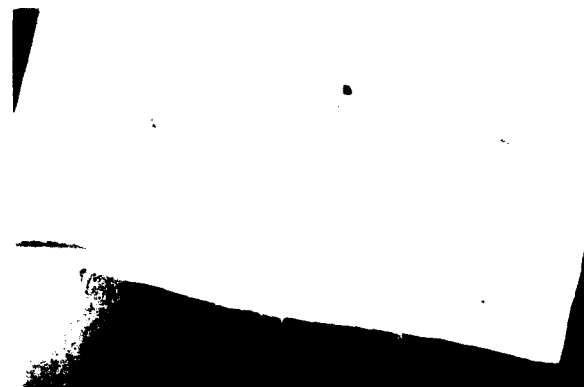

View of skirt and lining at zipper opening. Zipper opening to be completed by hand.

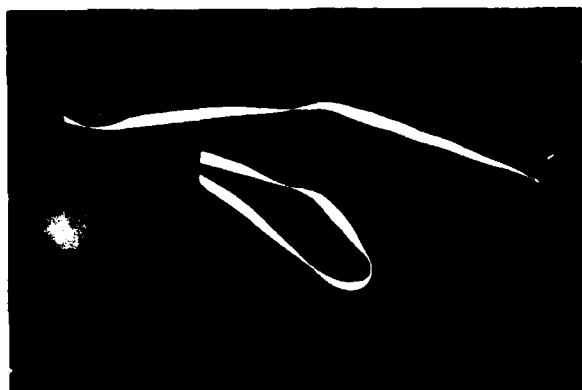

Prepare skirt hanger strips.



Attach skirt hanger strips to inside of skirt at side seams.



Position fusible waistband interfacing to waistband of skirt.



Press, steam and pound interfacing in place.



Waistband with fusible interfacing attached.



Overedge waistband at free edge. (Not edge to be attached to waistline.)



Overedged waistband seam.



Press waistband in half following slotted line of interfacing in preparation for next sequence.





Place skirt on individual and fit waistline area.



Pull threads and ease fullness where needed.



Place fullness over pressing ham and distribute evenly.



Steam fullness.



Place skirt on individual and fit waistband over eased skirt.



Find location for elastic placement and position in place for proper fit.



Place elastic on marked section of waistband.



Stitch elastic in place on three sides.



Elastic placed on both sides of waistband.



Fit waistline seam of waistband to waistline seam of skirt.



Waistband pinned to skirt.



Waistband in place ready for machine stitching.



Waistband stitched to skirt.



Waistband application to skirt waistline completed.

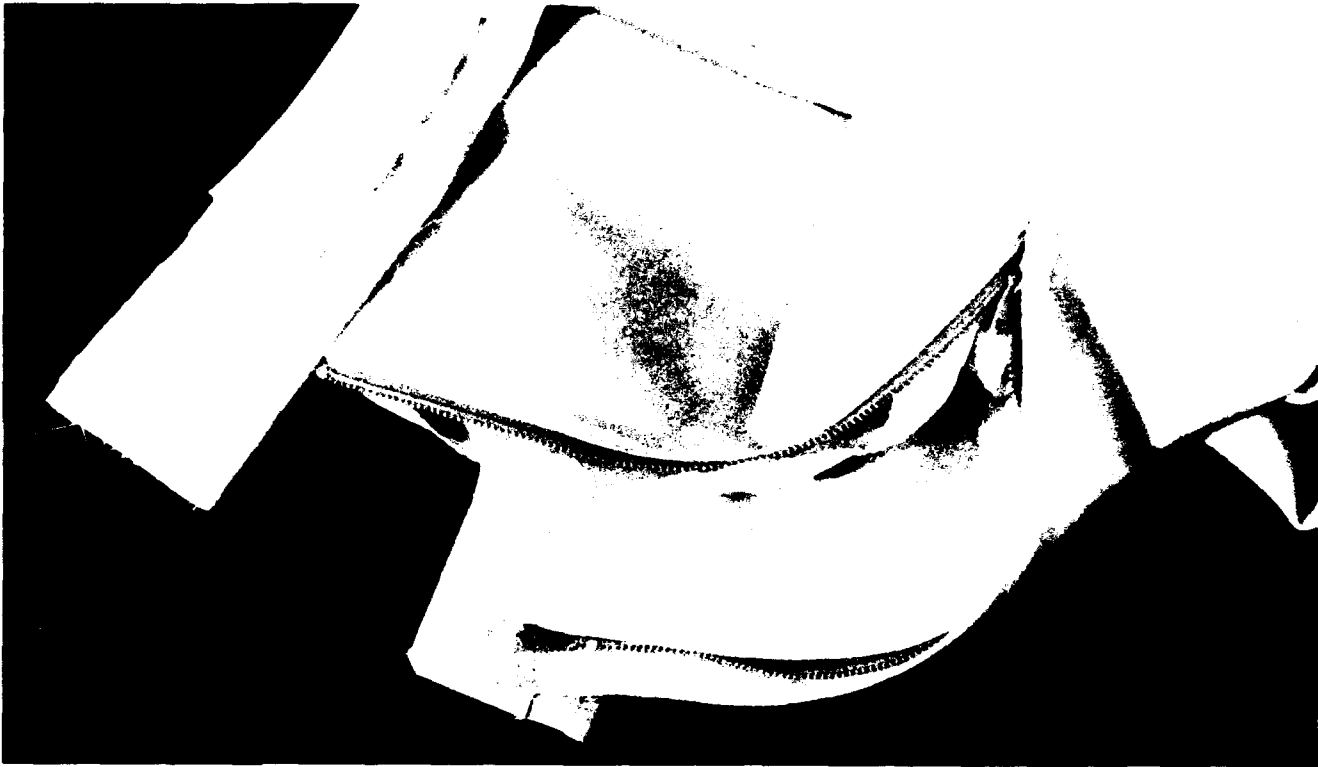

Stitch corner ends of waistband closed.



Corner ends of waistband turned and waistband folded in place.



On face side of garment stitch in the waistline seam through all layers to secure waistband to garment (crack stitch).

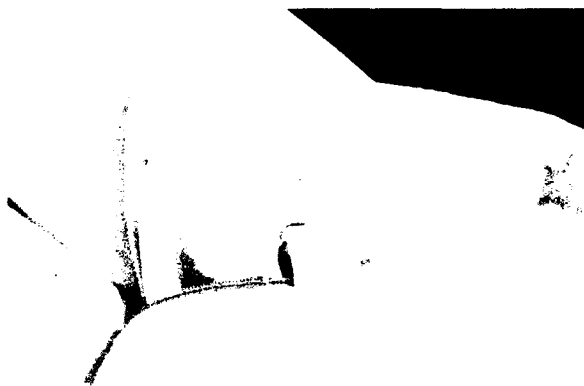

Inside view of waistline stitched to garment.



Completed garment with waistband attached.

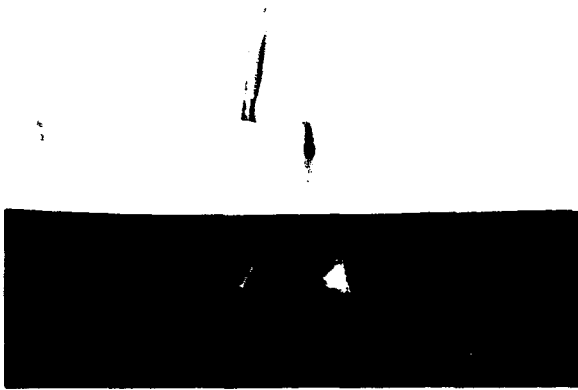

Skirt fasteners to be attached to waistband.



Skirt hook and bar fastener attached to skirt.



Lining opening hand stitched to zipper tape.



Place skirt on individual to mark hem length.

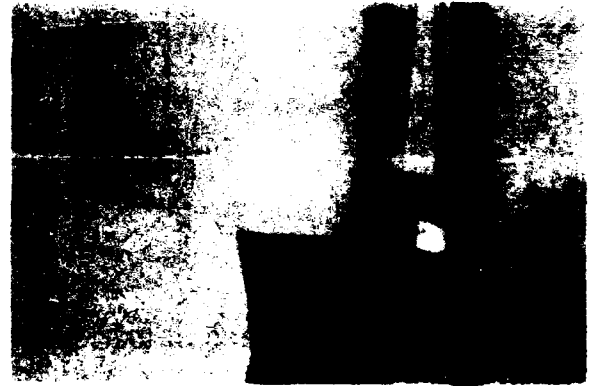

Marking hem with powder marking tool. Yardstick and pins may also be used.



Measure even hem depth from marked line and remove excess.



Apply seam tape/seam binding to lower edge.



Measure the established hem depth and pin in place.



Hand slip stitch hem of skirt.



Press hem in place and press inside seam of pleat from clipped areas.



Stitch pleat seams together to hold pleat seam fold in place.



Hem completed. Pleat seams stitched in place.



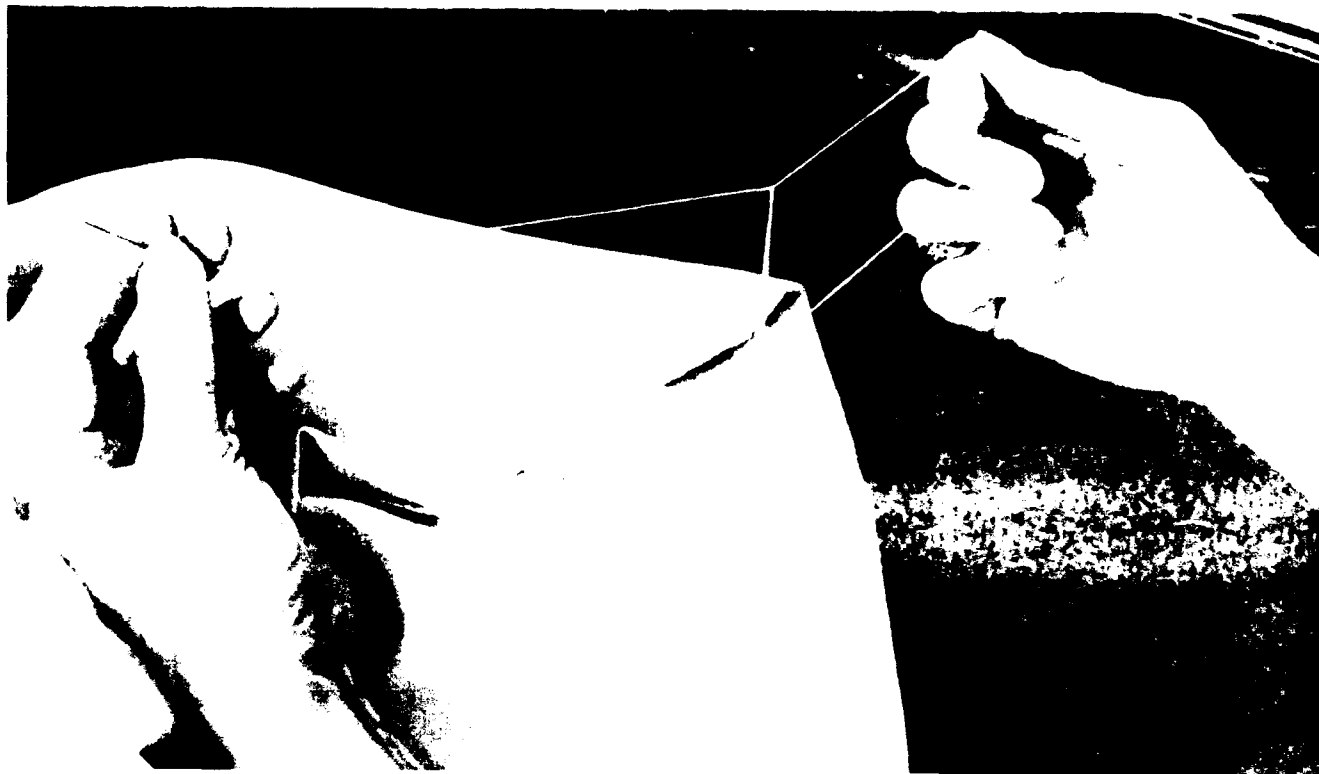

Making a hand chain stitch loop to hold lining to garment.



Chain loop operation completed. Lining and garment attached at hem edge.



Final pressing of skirt.



Completed skirt placed on individual. Side view of finished skirt.



Back view of finished skirt.



Front view of finished skirt.

## CHAPTER 5

# MADE-TO-MEASURE

**Made-to-Measure technology is directed toward customizing tailored clothing for individual customers. Made-to-Measure allows customers to select their own combinations of garment type, model styling, fashion details, piece goods and trimming. The garments are made to fit the individual's particular body type, stance/posture, and measurements.**

**Made-to-Measure tailored garments may be produced by :**

- △ **Conventional manual measurement techniques. The pattern is then drafted from the measurements following a specific style or model. Process is made possible in a custom clothier/tailoring environment.**
- △ **Using a try-on garment and recording the individual's measurements indicating the degree of alterations required. The specifications, other pertinent body data, and piece goods information are entered into the computer data file. Patterns of the selected style, in the computer style file, are adjusted to fit the individual's measurements and body type. The entire process is made possible through the utilization of a computer between the retailer and the factory.**
- △ **Three dimensional computerized measuring techniques which enable the individual's body to be computer scanned into the systems program. Pattern pieces in the data bank are altered to conform to individual's measurements and body type.**

**Made-to-Measure tailored garments may be:**

- △ **Assembled by Custom Clothiers or Custom Tailors using traditional "European" methods of fine tailoring.**
- △ **Assembled in a Traditional Factory within the regular production line or a separate section of the mass production environment.**
- △ **Produced utilizing all the advanced technologies of an Automated Plant such as computerized pattern adjustment programs integrated with computer assisted marker-making for fabric efficiency and computer generated single ply cutting. Assembly procedures would follow all the progressive automated sequences available at the facility.**

The Made-to-Measure chapter shows the procedure for custom fitting a man's jacket. The same process is applicable to a Made-to-Measure tailored skirt.

**SEQUENCE OF OPERATION IN A MADE-TO-MEASURE ENVIRONMENT:**

**I SELECT:**

- Fabric
- Lining
- Trim
- Style
- Fit
- Details

**II MEASURE:**

Specific areas and record measurements

**III FIT:**

Try garment on individual to evaluate fit and analyze corrections needed

**IV TRANSFER MEASUREMENTS AND DATA:**

- Into computer data bank
- To develop pattern
- To correct pattern

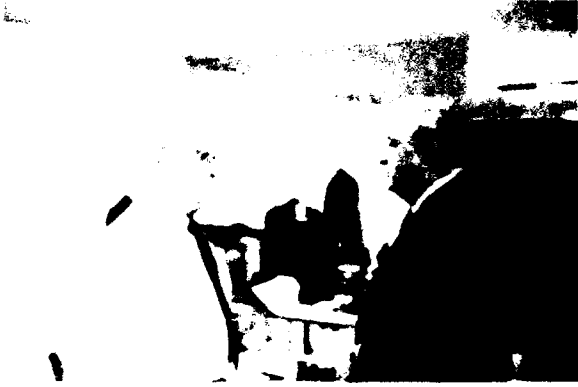

Customer visits Made-to-Measure facility for a Made-to-Measure garment.



Shell fabric and lining fabric may be selected from fabric books.

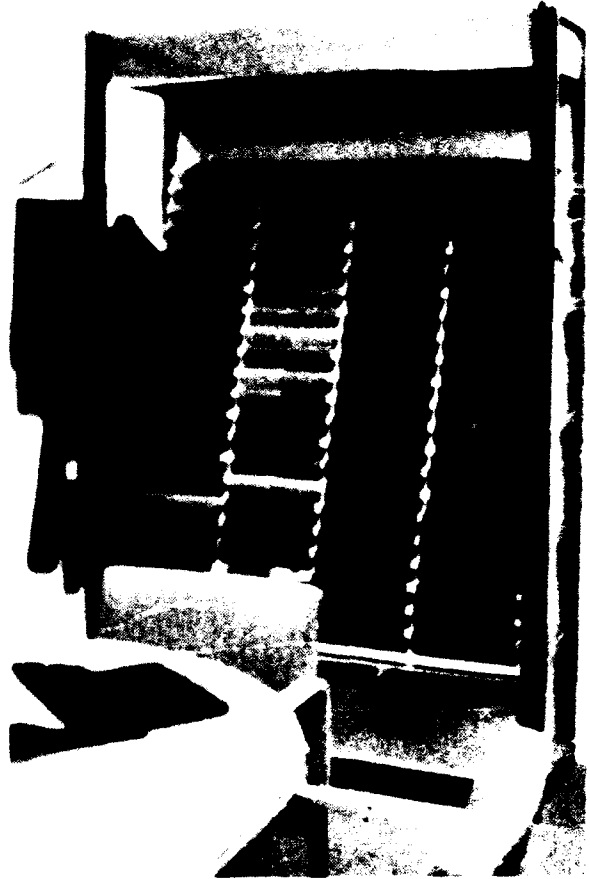

Fabrics for selection are displayed on fabric rack.



Customer selects garment type, garment styling and fashion details desired.



Try-on garment from inventory is selected for approximate size.



Client puts on try-on garment in style selected. Try-on garments are made in established sizes.



Try-on garment is analyzed according to individual's body type and stance.



Individual's measurements are taken. (Only a few are shown.)



Measurement for length of garment is taken.



Sleeve length of try-on garment is adjusted to client's desire.



Sleeve length measurement is taken.



Individual's body type and alteration requirements are selected from manual. Code name and number for pattern adjustments are recorded on form.

CUSTOM MADE ORDER: NO 126952  
MONOGRAM:

CLIENT'S CODE	YOUR ORDER NUMBER	MODEL WANTED JKT SKIRT V	FABRIC	LINING COLOR	SHIPPING DATE	COORDINATION NO.	DATE
---------------	-------------------	-----------------------------	--------	--------------	---------------	------------------	------

<b>SKIRT</b>		<b>VEST</b>		<b>MADE TO MEASURE</b>			
OPTIONS 2 DIGIT		OPTIONS 2 DIGIT		BODY CUT			
MODEL TRIED	SIZE TRIED	TOTAL LENGTH	LENGTH FROM WAIST LEFT	RIGHT	PANTS		
			IN	IN	OPTIONS 2 DIGIT		
AS THE TRY ON GARMENT				MODEL TRIED			
YES <input type="checkbox"/> NO <input type="checkbox"/>				SIZE TRIED			
IF YES, THERE IS NO NEED TO FILL THE NEXT SECTION				FINISHED INSEAM			
CODE POSTURE				1/2 WAIST			
CODE HIP				OPEN BOTTOM			
CODES HIP LEFT				YES <input type="checkbox"/> NO <input type="checkbox"/>			
RIGHT				IN			
1/2 CIRCUMFERENCE				AS THE TRY ON GARMENT			
CODE				BOTTOM WIDTH			
MEASURE				YES <input type="checkbox"/> NO <input type="checkbox"/>			
IN				IN			
3 DIGIT CODES (STARTING WITH 100)				IF YES, THERE IS NO NEED TO FILL THE NEXT SECTION			
L = LIGHT, M = MEDIUM, S = STRONG				3 DIGIT CODES (STARTING WITH 300)			
1 1/2 HIP				1/2 CIRCUMFERENCE			
1/2 THIGH				CODE			
1/2 WAIST				MEASURE			
1/2 DARTS				IN			
TOTAL LENGTH				3 DIGIT CODES			
SKIRT LENGTH FROM WAIST LEFT				RIGHT			
RIGHT				VEST			
				OPENING			
				TOTAL LENGTH			
				IN			
				1/2 WAIST			
				1/2 SEAT			
				OUTSEAM			
				INSEAM			
				RISE			
				BOTTOM			

Sample of form used to record customer/client information.

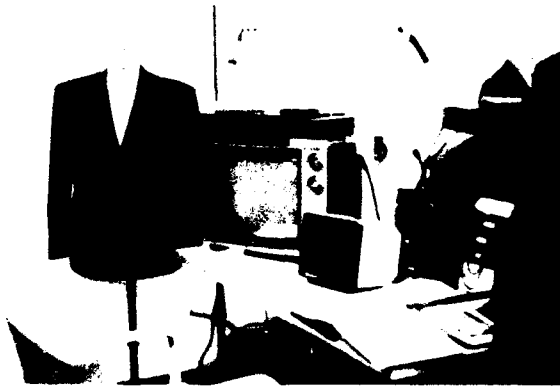

Telecommunication and computer station for computerized Made-to-Measure facility.



Program for computerized Made-to-Measure tailoring system is accessed.



Input for fabric selection and verification of availability.



Input model number and styling detail information.



Transfer specs from the Made-to-Measure order form to computer pattern file.

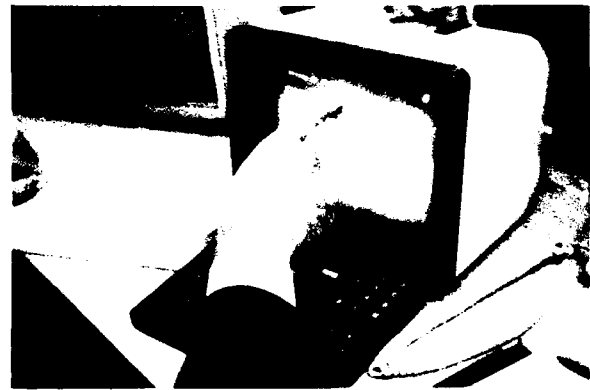

Verification of completed data for customer's garment.

Note: Made-to-Measure garments may be assembled by custom clothier methods, in a traditional plant, or in an automated plant.



## CHAPTER 6

# DESIGN FOR MANUFACTURING AND ASSEMBLY IN APPAREL

**Design for Manufacturing and Assembly in Apparel addresses three different methods of assembling and manufacturing a tailored skirt.**

**The assembling procedures of the tailored skirt were documented in a Sample Room where the style originated and the first pattern and sample garment were developed; Traditional Plant where mass production methods are employed; in an Automated Plant where computer controlled and high technology equipment are used during the production process; and in a Custom Clothier establishment where one garment may be assembled by one individual or handled by several tailors skilled in completing particular segments of the garment.**

**The designer and project leader, as well as other members of the project team, were aware of machinery, equipment, engineering functions and production operations in all of the facilities. Finishing methods and applications for seams and hem edges were performed based on price point of garment, machinery and attachment availability, and production procedures employed in the different plants. The inside edge of the waistband could be overedged/serged; or it could be bound with bias binding. The seams could be serged on an overedge machine; on a semi-automatic overedge machine programmed to cut threads at the completion of the operation, or finished on a fully automatic serging unit programmed to serge desired edges of the garment. Zipper insertion methods include choices of lap zipper application; centered zipper application; or invisible zipper application. Type of application selected will depend on end-use requirement.**

**While documenting all operations performed that were necessary in the development of the design, pattern generation, and assembling of the garment, changes were made to the pattern to facilitate ease of manufacturing and production efficiency as needed to take advantage of the technologies each environment offered. Changes had to be made to the original pattern.**

**Focal points of suggested changes for fabric utilization, assembling efficiency, quality control, costing, and utilization of equipment, included: pocket placement; coin pocket application; width of center back seam designed with inverted pleat; and shape of side back seam of side pleat.**

**Changes:****POCKET**

- a. **Customer Clothier** procedures allow for the most intricate assembly of the pocket and coin pocket within the detail of the hip yoke.
- b. **Traditional Plant** procedures also allow for the assembling of the pocket within the details of the hip yoke. For production efficiency and ease of manufacturing the coin pocket was applied using patch pocket application. The square shape of the pocket bag could be designed rounded for ease of assembly. (see coin pocket page 145).
- c. **Automated Plant** procedures allow for assembling the tailored skirt following methods and applications used in the Traditional Plant. Evaluating the application to take advantage of equipment, production efficiency and ease of manufacturing, the pocket was designed in the side seam of the garment and the coin pocket was applied two different ways. The side seam pocket application would not allow for efficient use of automatic side seamers. The square shape of the pocket bag could be shaped rounded for ease of assembly. (see coin pocket page 146).

**COIN POCKET**

- a. **Custom Clothier** assembling allows for the most intricate application of the coin pocket providing a clean edge finished within the seam of the front yoke.
- b. **Traditional Plant** assembly process; The coin pocket was applied to the face of the pocket lining using a patch pocket application. Patch pocket application requires less matching, clipping, and turning, thereby reducing the time factor.
- c. **Automated Plant:** The patch pocket application to the pocket lining was used as shown in Chapter 3. Evaluating the application for ease of manufacturing and production efficiency, the pocket was designed to be placed within the side seam of the garment. The coin pocket could then be applied within the seam of the waistband or as a patch pocket inside the pocket itself as shown on pages 146 and 147.

**CENTER BACK SEAM WIDTH**

- a. **Custom Clothier** assembling process allowed for a 2" center back seam designed to act as a stay for the inverted pleat when stitched at the waist into the waistband of the garment.
- b. **Traditional Plant** assembly process can also follow the 2" seam allowance necessitating drill hole placement for sewing guides. The width and shape of the center back seam was changed by the designer to improve production efficiencies through better fabric utilization (marker yield); elimination of distortion of drill holes in cutting; reducing possibility of sewing errors while applying the zipper or chance of covering drill holes.

- c. **Automated Plant assembling process** would not be able to utilize automated seam sewing operation for a 2" center back seam, therefore, necessitating the seam allowance to be adjusted to acceptable widths. The inverted pleat was eliminated and replaced with a slit. The entire center back seam allowance was reduced to even and equal widths, to facilitate the use of automated equipment.

#### **SIDE BACK SECTION SEAM WIDTH AND SHAPE**

- a. **Custom Clothier assembling procedures:** The width and shape of the side back seam with side pleat is designed so that seam allowance acts as a stay to keep side pleat hanging straight and even when garment is worn.
- b. **Traditional Plant assembling procedures:** The width and shape of the side seam with side pleat could be assembled as designed. Matching and stitching seams of a wide and shaped seam allowance to cover the drill hole would be time consuming and costly. For ease of manufacturing, production efficiency and quality control the seam allowance was reduced to acceptable widths.
- c. **Automated Plant assembling procedures:** The width and shape of the seam allowance was reduced so seam allowances from waist seam to side pleat were even, allowing for better fabric utilization, ease of manufacturing, production efficiency, and reduced bulk in the seam area.

**NOTE:** The alternative procedure described here are illustrated on the following pages.

### POCKET AND COIN POCKET-CUSTOM CLOTHIER APPLICATION

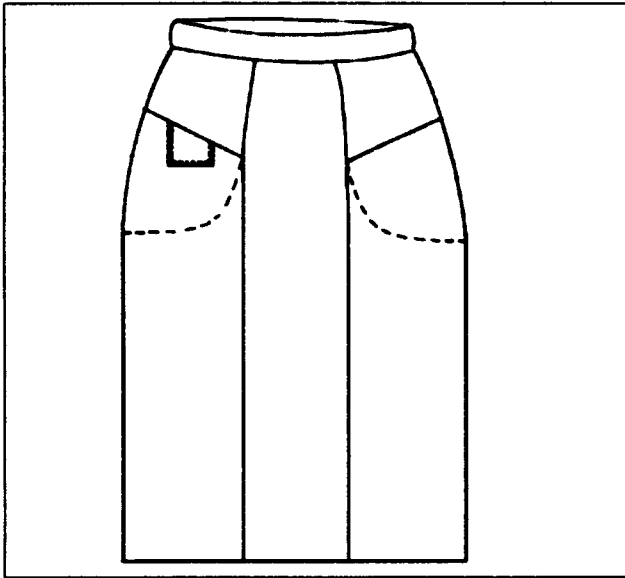

Skirt designed with pocket detail applied at hip yoke and coin pocket assembled at yoke line.

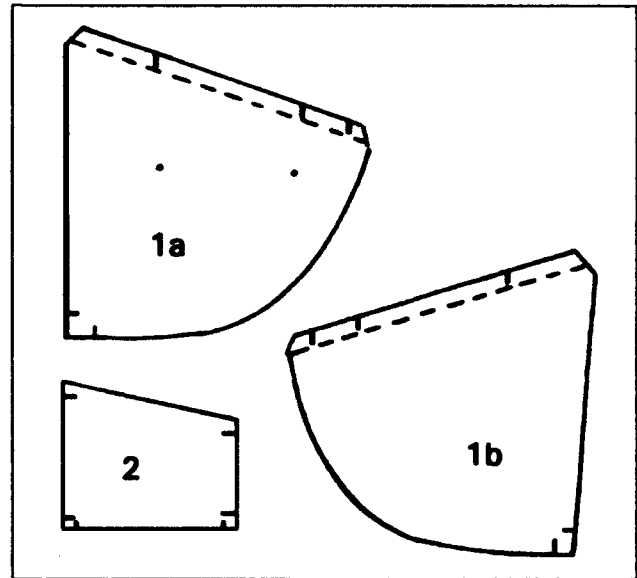

Pattern pieces for pocket cut of lining fabric.

1a - right front pocket lining

1b - left front pocket lining

2 - coin pocket for right pocket only.

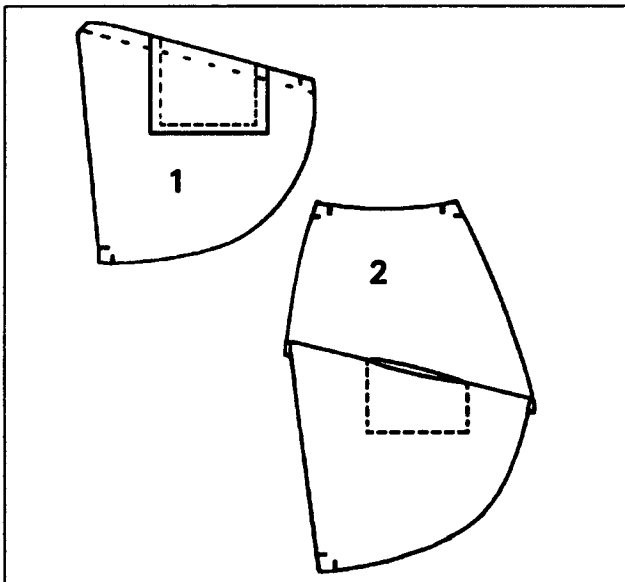

1. Coin pocket stitched to top edge of pocket lining.

2. Coin pocket assembling complete with pocket lining attached to yoke section.

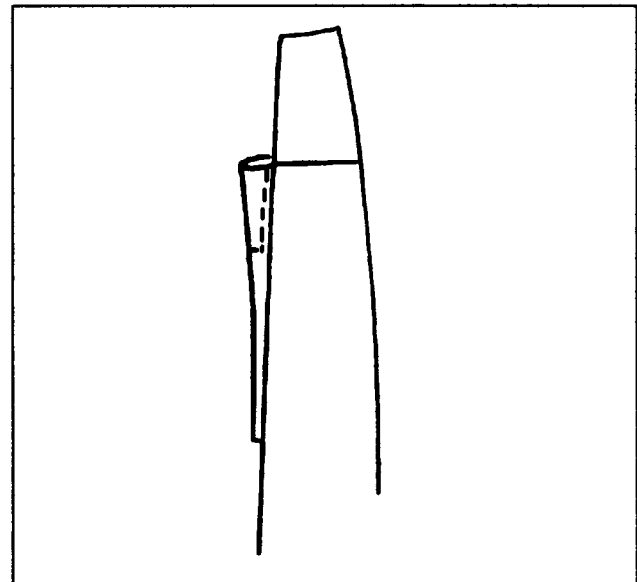

Inside view of completed pocket.

**POCKET AND COIN POCKET-TRADITIONAL PLANT APPLICATION**

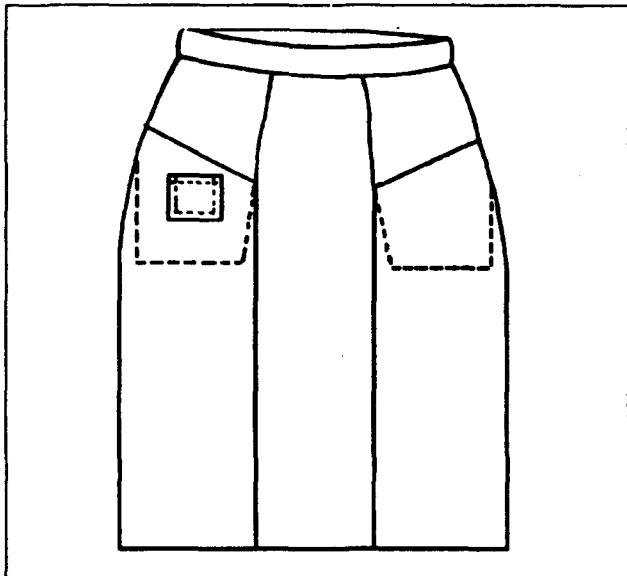

Skirt designed with pocket detail at hip yoke and coin pocket applied as patch pocket to pocket lining.

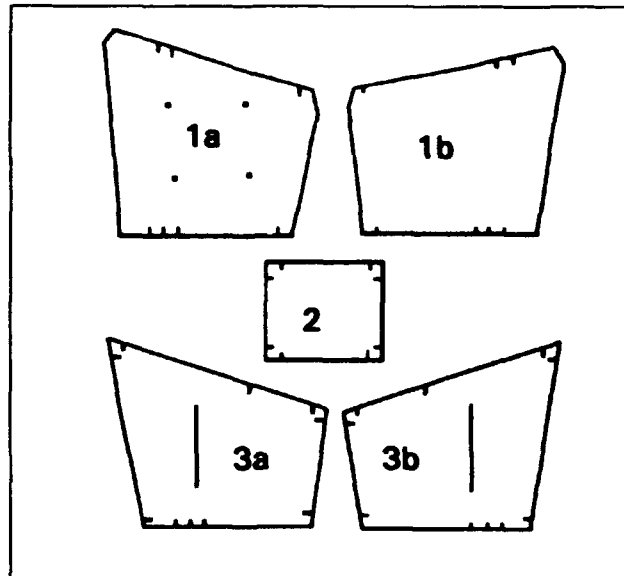

Pattern pieces for pocket.  
 1a and 1b. pocket linings  
 2. coin pocket  
 3a and 3b. pocket facing.  
 All pieces cut in lining fabric.

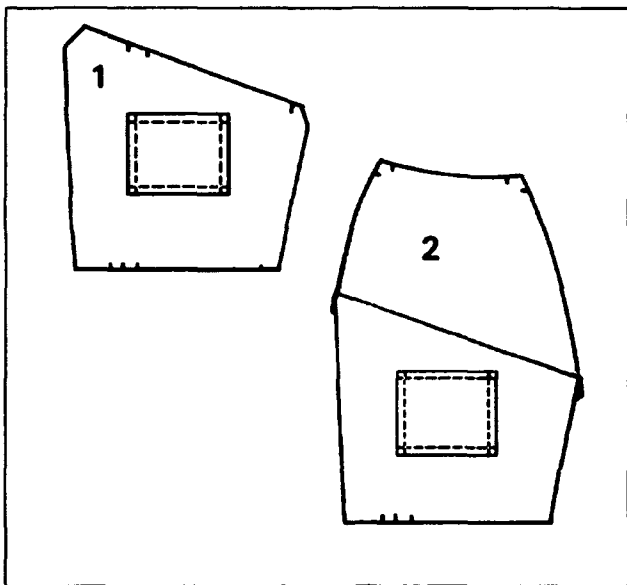

1. Coin pocket applied to pocket lining - patch pocket application method.  
 2. Pocket lining with coin pocket assembled to front hip yoke section.

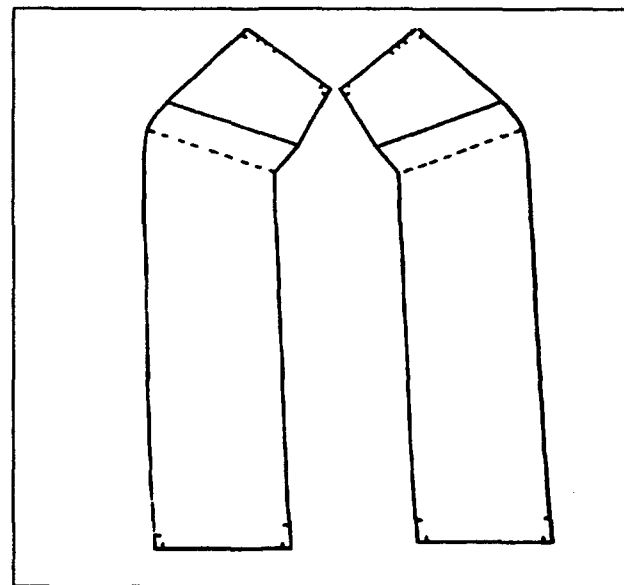

Pocket facing applied to side front section of skirt at pocket extension.

**POCKET AND COIN POCKET-AUTOMATED PLANT APPLICATION  
OPTION I**

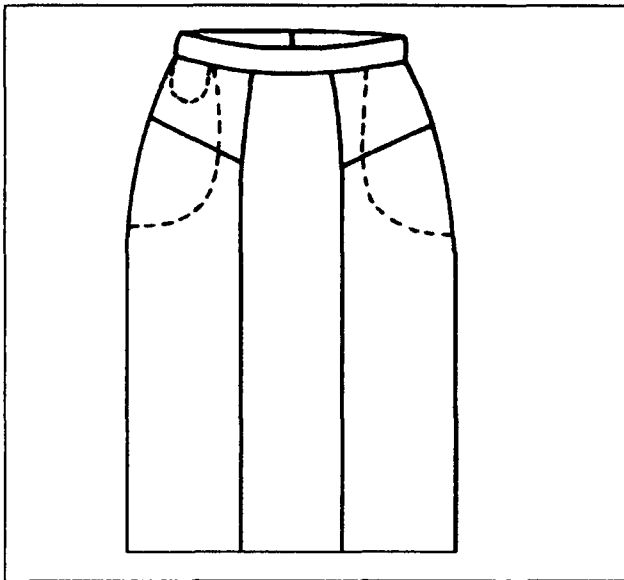

Skirt designed with pocket at side seam and coin pocket applied at waistline of skirt.

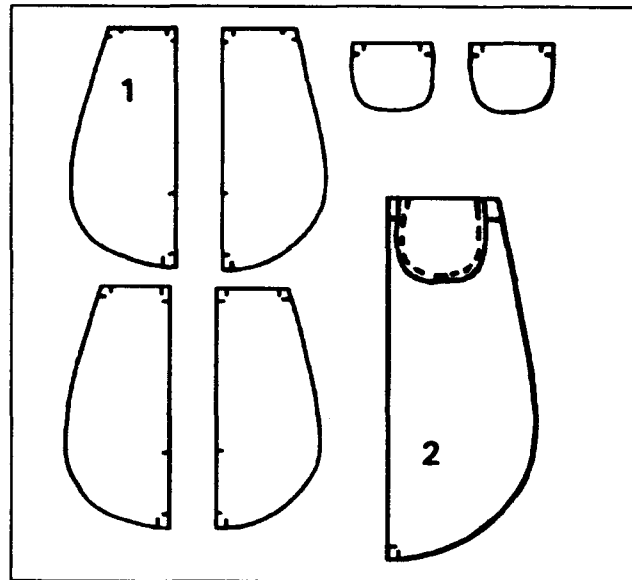

1. Pocket pattern pieces cut in lining fabric.  
2. Coin pocket attached to pocket lining at waistline.

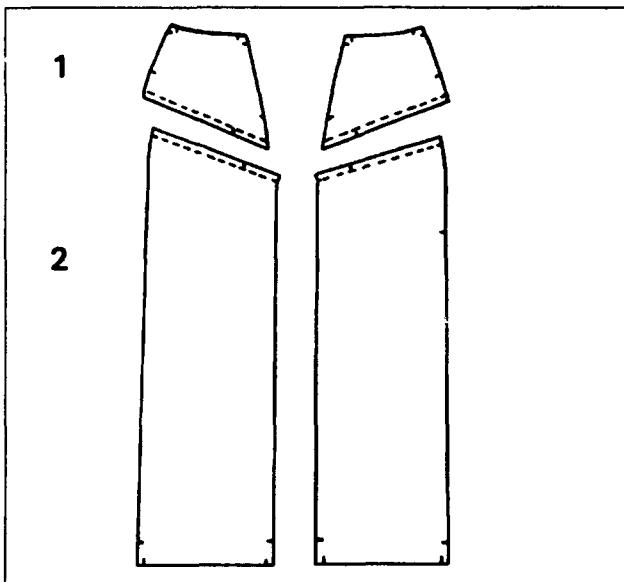

1. Front yoke sections.  
2. Front side sections.

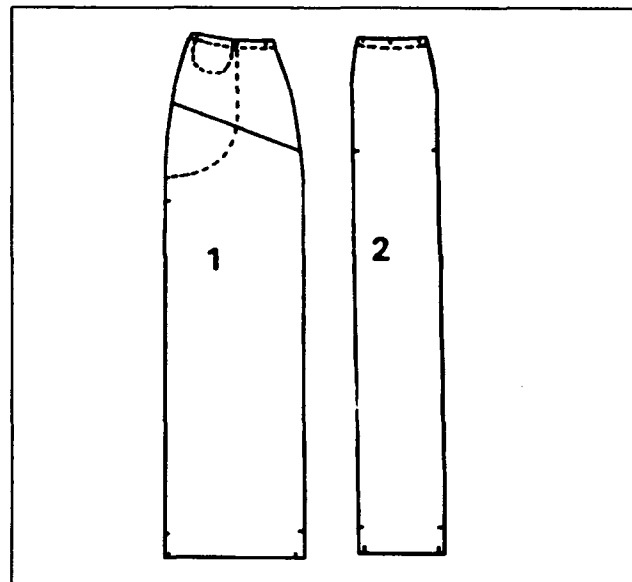

1. Yoke section assembled to side front section. View shows pocket application.  
2. Center front section of skirt.

### POCKET AND COIN POCKET-AUTOMATED PLANT APPLICATION OPTION II

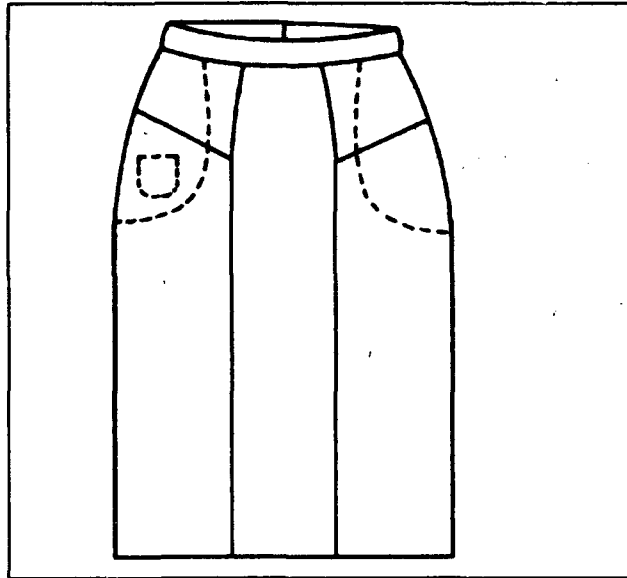

Skirt designed with pocket at side seam and coin pocket applied on pocket lining as patch pocket application.

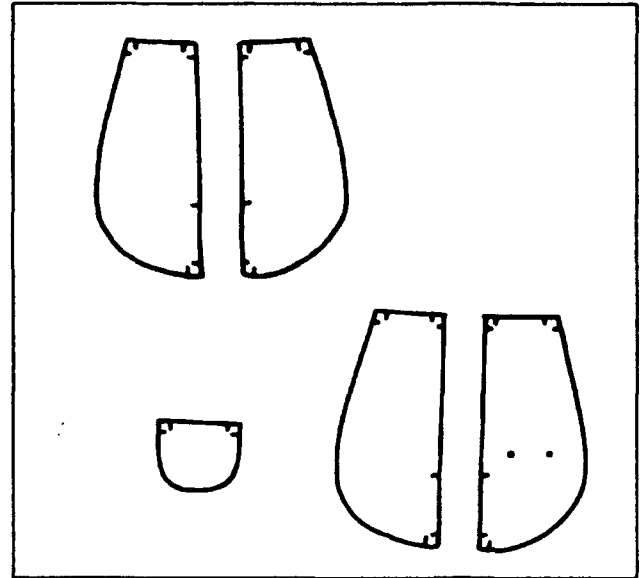

Pocket pattern pieces cut of lining fabric.

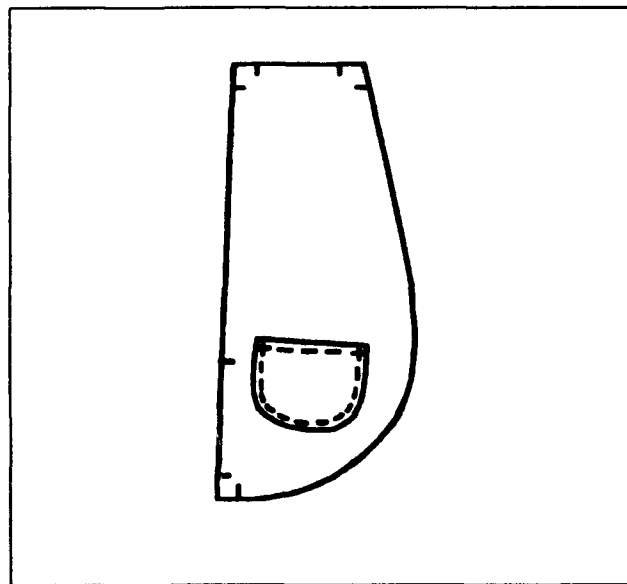

Coin pocket applied to pocket lining.

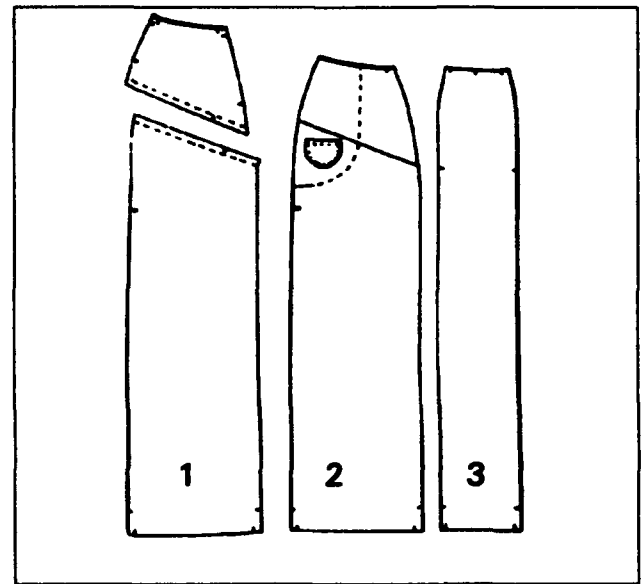

1. Front yoke sections and side front section.
2. Yoke and side front sections assembled and pocket inserted.
3. Center front section.

### CENTER BACK SECTION SEAM ALLOWANCE SIZE AND SHAPE CUSTOM CLOTHIER APPLICATION

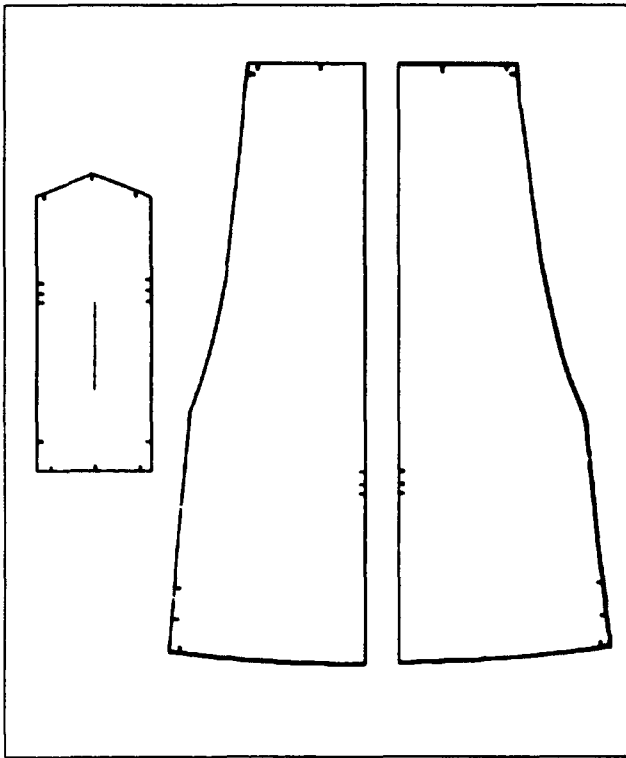

Center back sections. Pattern designed with 2" center back seam and wide shaped seam allowance for side pleat.

Seam lines are drawn on pattern with chalk to indicate sewing lines to be marked. There are no marks for drill holes. Chalked marks indicate where sewing lines start and end.

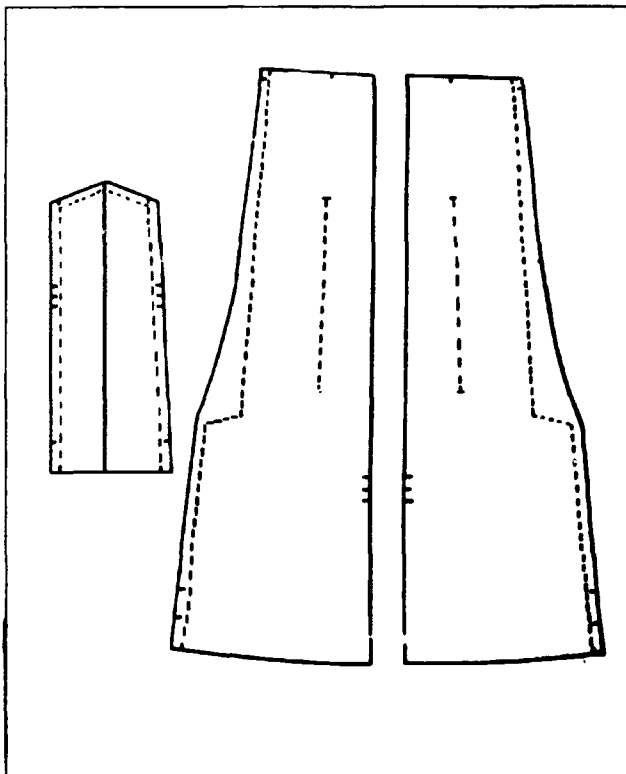

Center back sections shown with stitching line between marked areas for center back seam and for side back panel.



**CENTER BACK SECTION SEAM ALLOWANCE SIZE AND SHAPE  
TRADITIONAL PLANT APPLICATION**

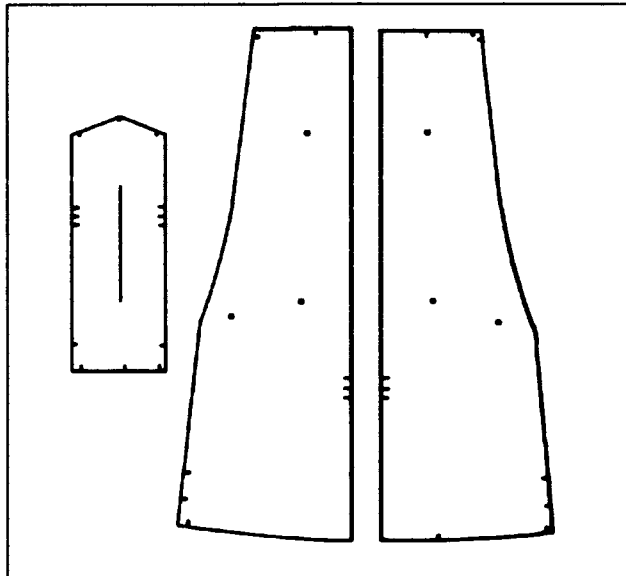

**OPTION I**

Center back sections. Pattern shows 2" seam allowance at center back. Side panel shows wide shaped seam allowance for side pleat and drill holes.

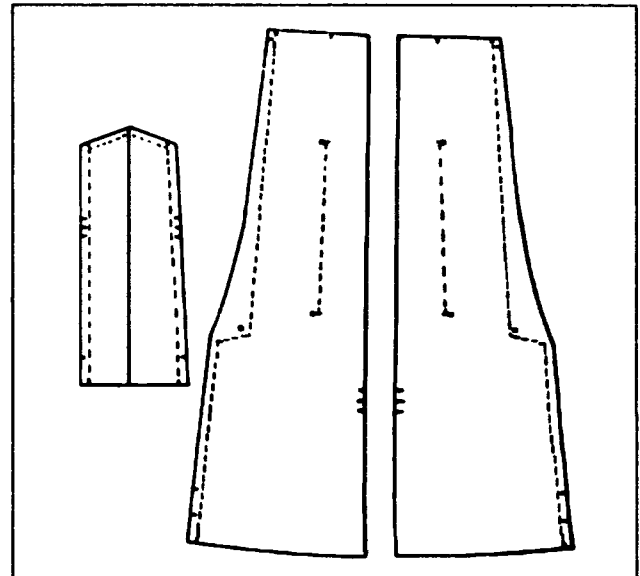

**OPTION I**

Center back sections shown with stitching lines between drill holes at center back seam and for shaped side panel seam.

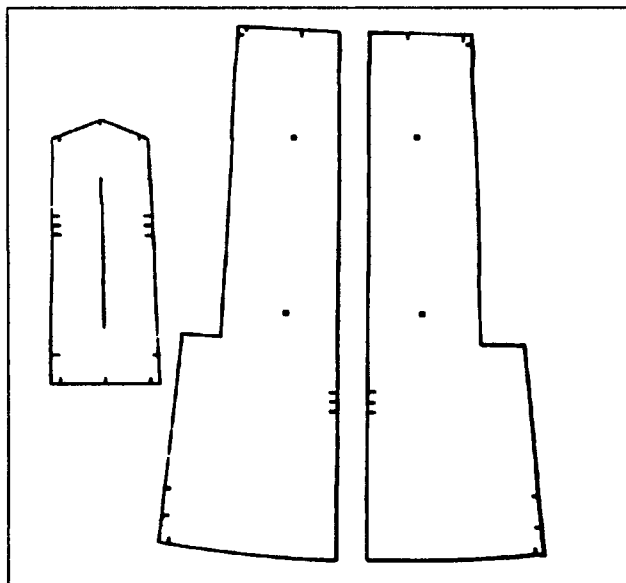

**OPTION II**

Center back sections. Pattern shows 2" seam allowance at center back and even seam allowance for seam with side pleat.

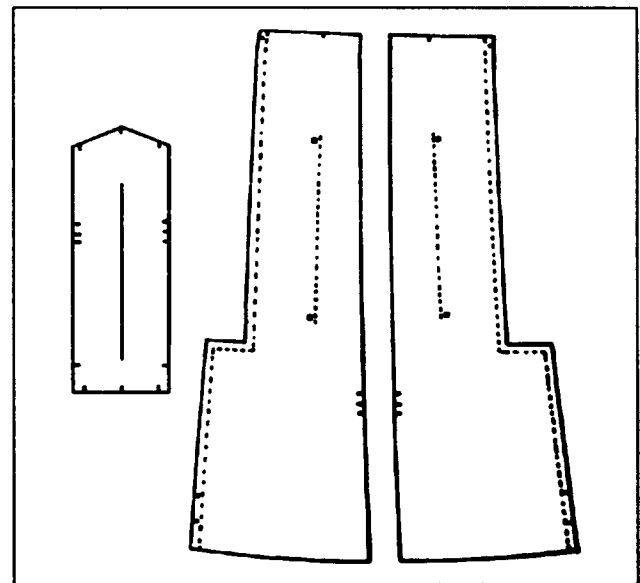

**OPTION II**

Center back sections shown with stitching lines between drill holes at center back seam and stitching lines for panel with side pleat.

**CENTER BACK SECTION SEAM ALLOWANCE SIZE AND SHAPE  
TRADITIONAL PLANT APPLICATION**

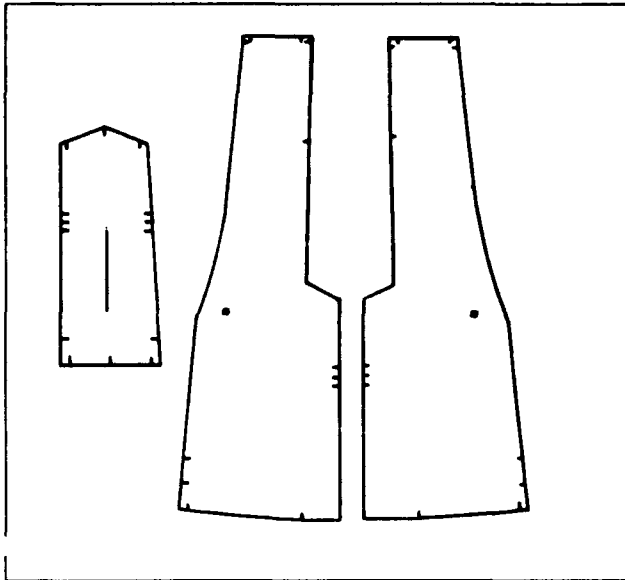

**OPTION III**

Center back sections. Center back seam reduced to even seam allowance. Side panel retains wide shaped seam allowance for pleat.

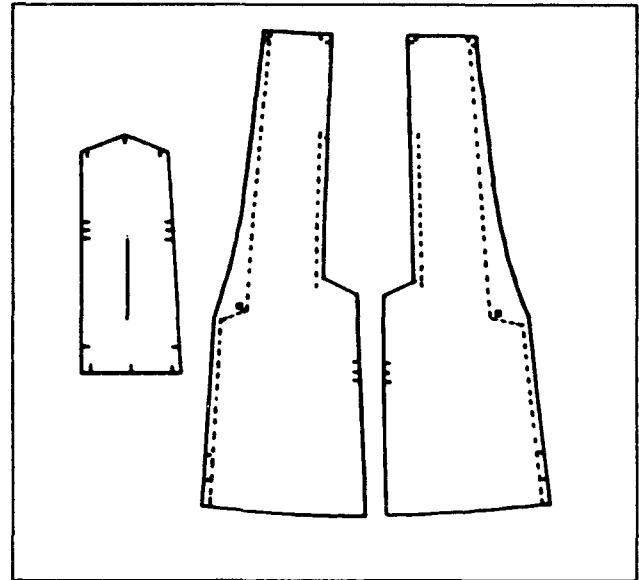

**OPTION III**

Center back sections show stitching line between notches and stitching lines for side panel.

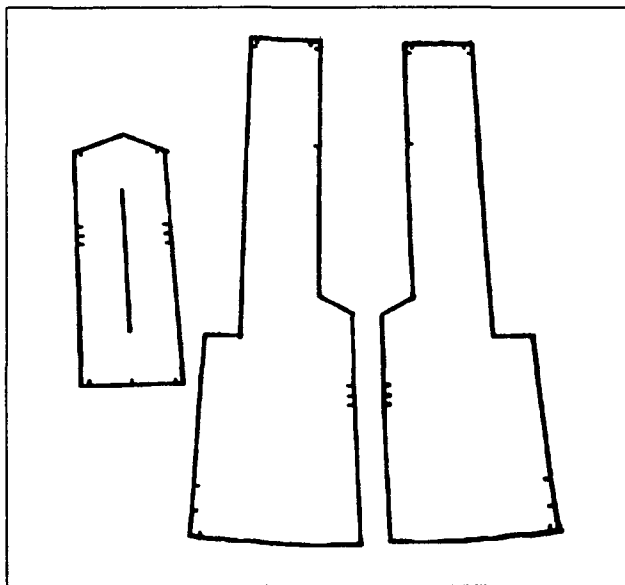

**OPTION IV**

Center back sections. Seams reduced to even seam allowance for center back seam and for side panel seam.

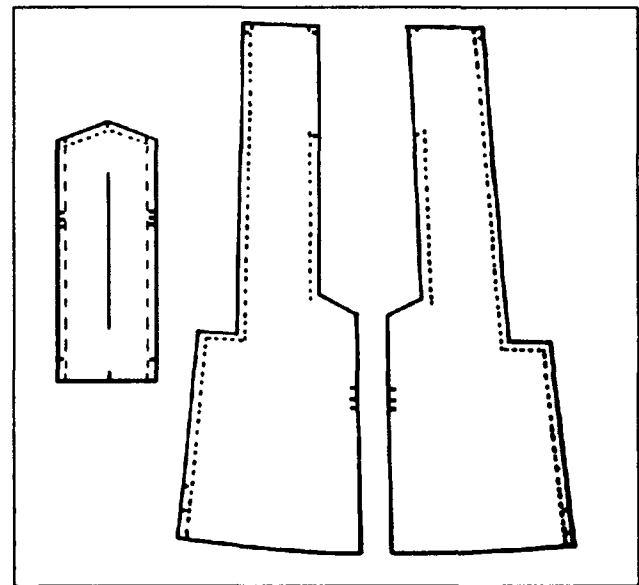

**OPTION IV**

Center back sections show stitching lines for center back seam with inverted pleat and side panel seam with side pleat.

**CENTER BACK SECTION SEAM ALLOWANCE SIZE AND SHAPE  
AUTOMATED PLANT APPLICATION**

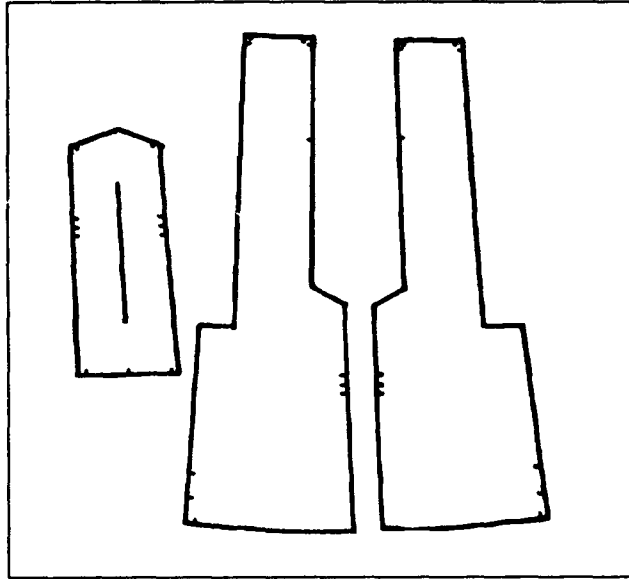

**OPTION I**  
Center back sections. Seams reduced to even seam allowance for center back seam and for side panel seam. Drill holes have been eliminated.

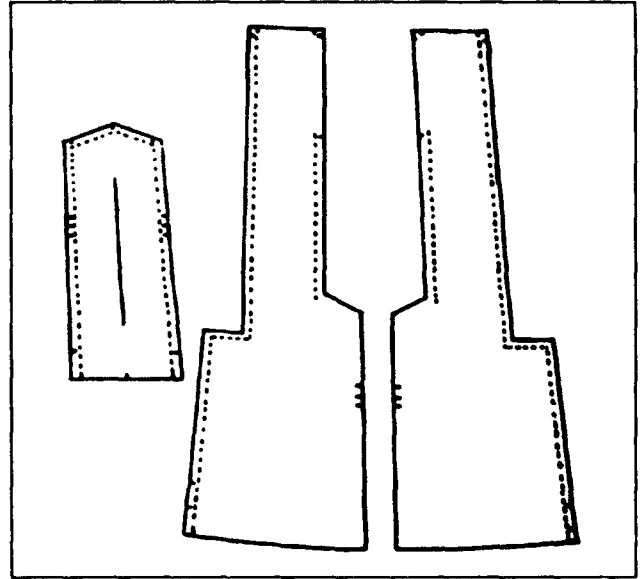

**OPTION I**  
Center back sections shows stitching lines for center back seam with inverted pleat and for side panel seam with side pleats.

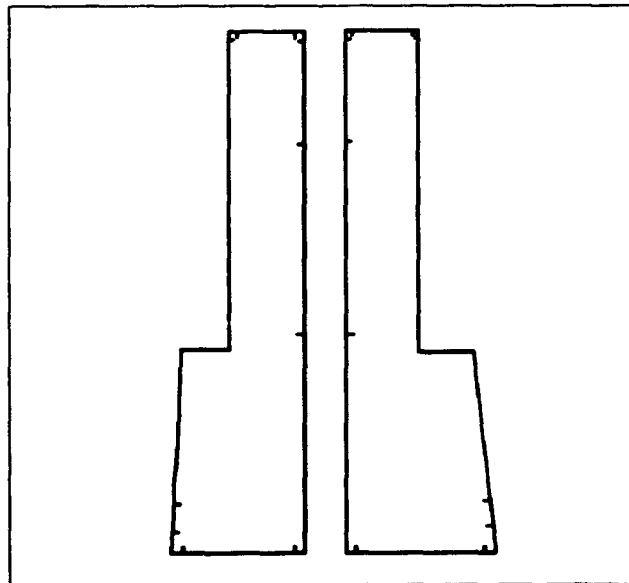

**OPTION II**  
Center back sections. Inverted pleat has been eliminated and slit opening has been substituted. Drill holes have been replaced with notches.

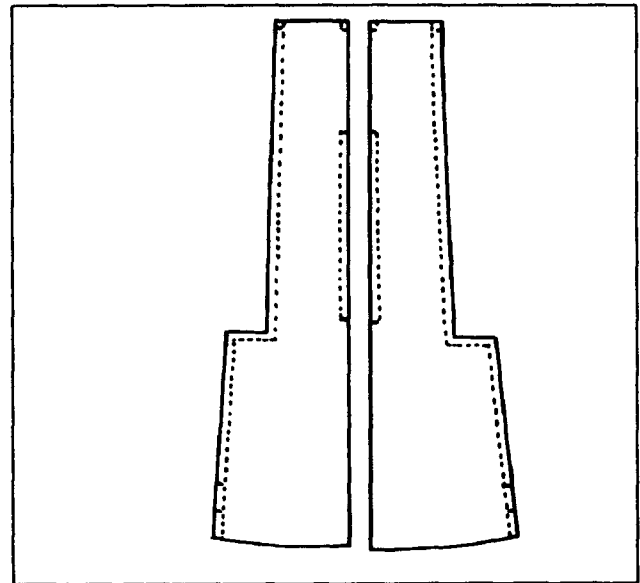

**OPTION II**  
Center back seam shown with stitching line between notches allowing opening for zipper application and for slit opening.

**SIDE BACK SECTION SEAM ALLOWANCE SIZE AND SHAPE  
CUSTOM CLOTHIER APPLICATION - TRADITIONAL PLANT APPLICATION  
AUTOMATED PLANT APPLICATION**

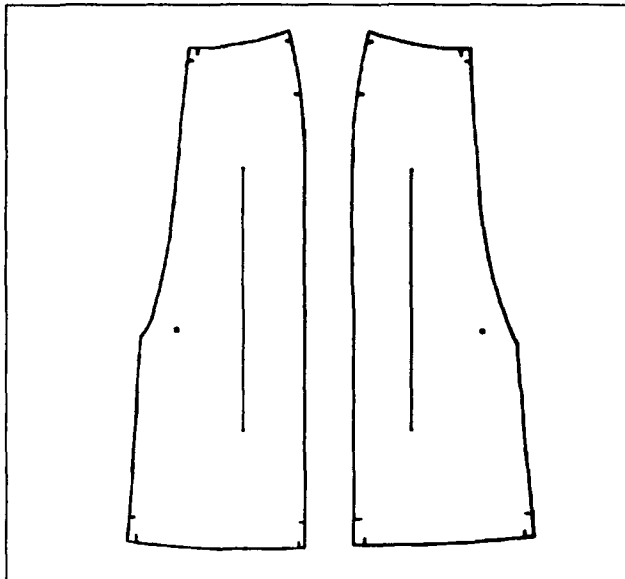
**OPTION I**

Back side sections with side pleat. Side pleat seam has wide seam allowance shaped to allow for pleat stay.

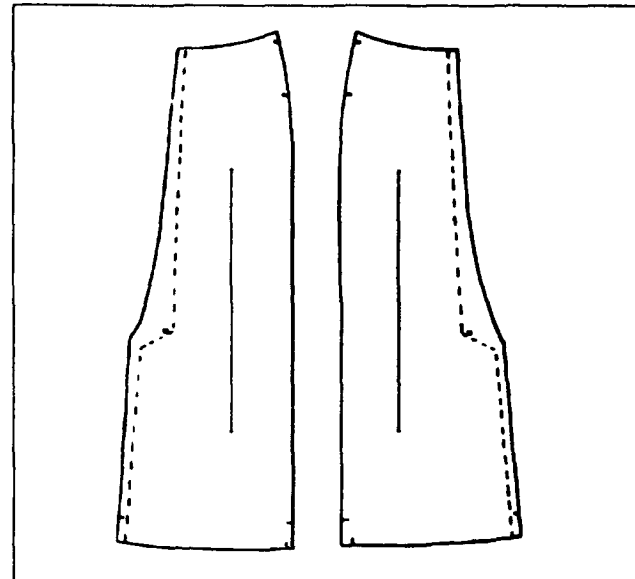
**OPTION I**

Back side sections shown with stitching lines for wide seam allowance and shaped side pleat seam.

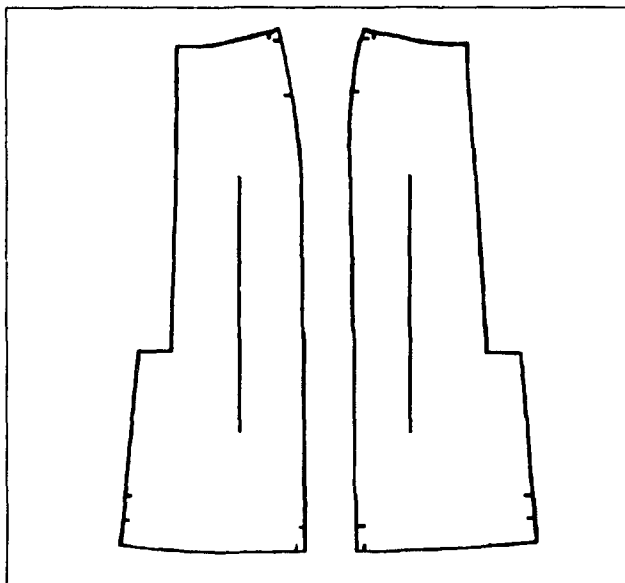
**OPTION II**

Side back sections. Seams reduced to even seam allowance and pleat shaped for ease of assembly.

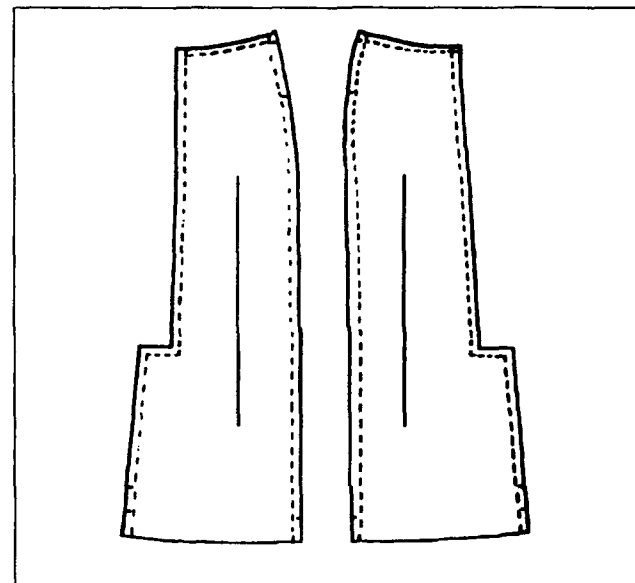
**OPTION II**

Side back sections shown with stitching lines following size and shape of seam with side pleat.

## **CHAPTER 7**

# **FLEXIBLE MANUFACTURING**

Prior to the 1980's the apparel market was sales driven. Consumers were told what products they would like and given specific times to buy them in the stores through limited distribution networks. Over the last decade the marketplace has been evolving with fundamental changes.

Consumer driven merchandising has led to revision of the manufacturing processes employed in the past. Customers today want to be able to buy the product that they need at the time that they need them, not three to six months in advance. The economic conditions of the times, along with the demands of the workplace, have created new challenges.

The shift from the traditional channels of distribution to convenience shopping has resulted in the growth of specialty stores, mail order catalogs, and television cable shop-at-home services. Consumers are also more aware of quality. Because of these changes, apparel manufacturers have been looking at their infra-structure and resources in order to respond to changing consumer needs. The challenge has been to find ways to shrink the time from demand to delivery.

Apparel manufacturers are using a variety of approaches, and in many plants a combination of strategies are in place under the same roof. This type of incorporation and implementation is referred to as FLEXIBLE MANUFACTURING.

Techniques which often are integrated into these flexible production facilities include: PROGRESSIVE BUNDLE SYSTEM, MODULAR MANUFACTURING SYSTEM, and UNIT PRODUCTION SYSTEM, among others. They may be employed together to get the right product out at the right time to the right place at the right price. When the garment is needed, then management, quality assurance, and the operators will meet to develop the accepted method of production for that product. These systems are described in this chapter.

Since military apparel must follow specific methods of construction and tolerances, meetings are geared to educate the workers on the differences between what they have been making and the new product that is coming.

Not all garments lend themselves to one or all traditional or automated technologies. A manufacturing plant can have a traditional bundling system, a unit production system, or a combination of both.

Typically, an apparel plant requires approximately five to eight days for the assembly of a garment. Incorporating the Unit Production System (UPS) appreciably reduces the time requirement for assembling a garment, sometimes to one or two days or less.

The advantage of progressive bundle systems is that the workplace can be designed to perform a specific operation utilizing the best machinery, work aids, and trained operators. The disadvantages are that companies cannot respond to rapid change and they carry high work in process inventory and throughput time is long.

If a company is approached during mobilization, then a modular based plant may be planned. The basis of this structure is quick response. New work may be entered into the system and completed in days instead of weeks. Various modules can be set up to either produce sections of a garment or complete garments.

As one example, traditionally the shell of the garment is made in one area, and the lining in another. In the module, a group of operators make the shell and the lining. It is not always possible to follow a specific sequence of operations to be used in production. Likewise, not all of the machines can be arranged in a set manner.

To overcome the disadvantages of the bundle system and to successfully accommodate the flexible manufacturing of a product or group of products, there is a recommended sequence to follow:

Management of the firm allocates resources for the module and/or UPS and makes a commitment to its successful implementation.

The product to be manufactured must be analyzed and the team members of the module consulted to develop the most appropriate means of assembly.

Any technical changes, work aids, etc. that will be needed, must be developed ahead of time and be ready to be implemented as the product arrives from cutting. There is no excess time in the system for delays of this nature. If unprepared, then the line will shut down.

Operators need to be trained for the modules before they can be assigned to the assembly processes of the modular set-up.

The operators must be cross-trained on a minimum of three operations. It is recommended that they know all of the operations within the module, but the number of operations on complex garments may make this extensive cross-training economically impractical.

The compensation method has to be understandable by management and operators. It should be made clear that this may be changed as the experience of the company with modular manufacturing develops.

Group incentive systems may replace or supplement individual piece work.

An organized method of communication between management and operators must be established and used on a regular basis.

By permitting more and quicker changes in product and in production sequences, Flexible Manufacturing systems provide greater creative opportunities for designers and their merchandising managers. This reinforces the current marketing orientation of apparel business via quick response to consumer needs.

With the plant's ability to make changes of products and styling more easily and inexpensively, the product development team can inject new styles into the product cycle as the current season progresses and consumer reaction is reflected.

The design team also must be organized to compress the time cycle for new product development. Strict adherence to a timetable, use of computer aided design systems to reduce prototyping time, parallel action and decision making to replace sequential action, and consultation with production management are among the ways to achieve faster product development.

Sewing equipment which can be easily changed over to follow different seam configurations also play a role in flexible manufacturing systems. These advanced mechanized machines often have programmable micro processors and other electronic devices. Robots may also be used.

On the other hand, designers should use standard parts and configuration to the fullest extent that the desired aesthetics of the garment allow.

**eton**

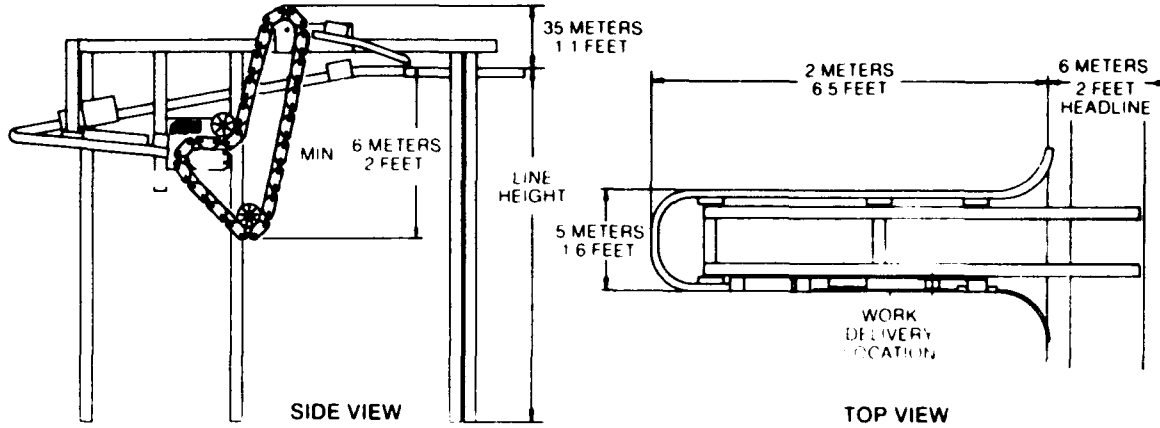

Unit production system schematic.



Flexible chain.

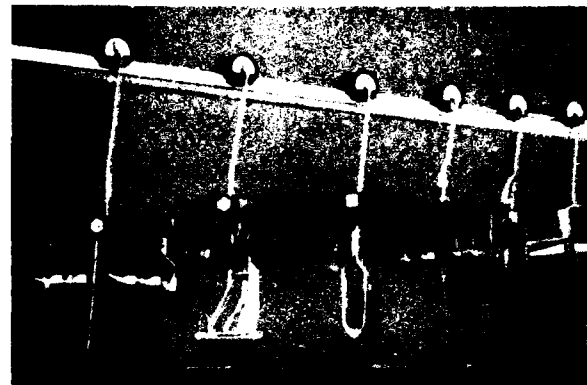

Specialized product carriers.

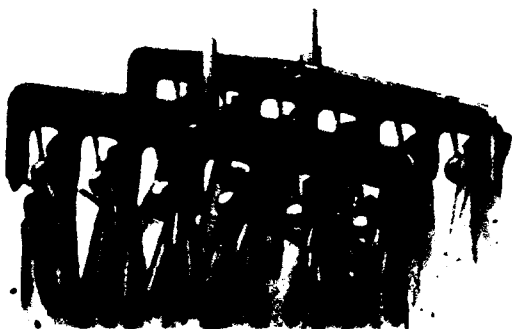

Product on carriers.



Unit production system work station.

Photographs and information courtesy of:  
ETON SYSTEMS, INC., Alpharetta, Georgia



# UNIT PRODUCTION SYSTEMS

The unit production system (UPS) is a mechanism by which garments move through the production process. A typical UPS consists of an overhead chain driven conveyor, a series of workstations, carrier transporters that can hold from one to a dozen garments or garment sections, and work place controllers that interface with the system controller and can display a full series of data about the operator or garment being produced.

The two elements of a unit production system are a computerized control system and a computerized management reporting system. The control system is used to signal the UPS to move a hanger/carrier to the next station. The operator indicates to the UPS that the operation has been completed and the hanger/carrier is ready to be moved to the next scheduled station. The management reporting system is used to record production and payroll data.

Using UPS, the garment moves from work station to work station and each operator is responsible for one stage of the sewing or assembling process. After each part or operation is completed, the operator replaces the piece on the moving carrier and it travels to the next station and stage of assembling operations. Operations may be carried out while the garment remains hanging in the product carrier.

## UNIT PRODUCTION SYSTEM:

The sequence for each style of garment being produced is loaded into the computer by the supervisor prior to its arrival at the loading station

The parts are loaded in a predefined position to minimize handling throughout the production

Garments are loaded onto carriers by the first operator or at a special workstation for loading

The carriers are coded either with a bar code, or reprogrammed chip in the carrier, and the sequence begins

As an operation is completed the information is fed into the system controller and the carrier is automatically directed to its next workstation until it is completed

If a station is full, or another is empty, the information is fed to the supervisor who can adjust the flow, reassign operators, or let the system continue to run on its own backup controls

There are advantages and disadvantages of a UPS to be considered.

**ADVANTAGES:**

- You can see all of the work being produced
- If there is a quality problem it can be seen within a few garments thereby minimizing repairs, seconds, and irregulars, which are costly
- Reduces handling time as bundling is eliminated
- Lifting and pulling of bundles is eliminated
- Reaching and bending for work-in-progress is eliminated
- Reduces work in process as inventory between operations is measured in pieces instead of bundles
- Allows the use of one workstation to perform multiple operations
- Can handle multiple garment constructions at the same time
- Automates payroll
- Allows for the consideration of real-time manufacturing and computer integrated manufacturing (CIM)
- Captures computerized production and work-in-process data

**DISADVANTAGES:**

- Expensive to install, though payback on the investment is generally less than two years
- Requires a good planning system to make sure that all of the raw materials are in the right place, at the right time, as missing direct materials will shut down the line.
- Absenteeism and turnover are more critical than with the progressive bundle system because there is less work-in-process
- More floor space is required
- Employees need to be trained for multiple operations

# MODULAR MANUFACTURING

One of the innovative management techniques now being used in some apparel companies is MODULAR MANUFACTURING, which consists of more employee involvement teamwork, and less use of individual incentive systems (piecework). In a modular environment, responsibilities and accountabilities are distributed more evenly between the line supervisor and the teams. Modular manufacturing enables managers to focus on managing people instead of production.

The modular concept requires a team approach in the manufacturing and assembling of a garment. A group of four to seventeen people work together to produce a finished garment. In modules, each team member works on more than one procedure and members of the team are proficient at more than one operation. Some operators are proficient at each operation.

The modular method reduces through-put to fewer days compared to using the progressive bundling system. Modular manufacturing reduces work-in-process. Using the modular approach, a garment goes from operator to operator with no build up of work-in-process in between.

For the assembly of the skirt described in this handbook, a modified modular manufacturing scheme may be initiated. Each part of the skirt assembling process may be section designated. Each section then becomes a modular unit, with separate units for producing the front, back, waistband, lining and final assembling and finishing.

In a modular set-up where operators have an assigned job or operation to perform, they will rotate to another operation when needed in order for the work progression to be caught up.

Managing modular manufacturing entails keeping consistency of the product that is fed to the operator. The development of a modular production plan should address;

- Work-in-process ..... single piece vs bundle
- Type of modular to use..... stand-up vs sit-down
- Amount of space and equipment needed
- Type of pay plan
- Start up costs

## THE JAPANESE KANBAN MODULAR STYLE:

The operators of a Japanese Kanban modular team work in a standing mode with the last operator of the line pulling the work through the line. Each operator knows how to run all of the operations of the unit and continues to move down the line with the garment until the operator behind comes up to take over the garment and sends the first operator back down the line to the preceding operator in the line, and so on.

**THE JAPANESE KANBAN MODULAR STYLE: (cont'd)**

This type of line is usually a "C", "U", or "J" configuration. Each operator needs to see all of the other operations within the group, and be able to move quickly to fill in the line when needed. As work is passed from operator to operator the distance between operations is minimal.

**ADVANTAGES:**

- Reduced work-in-process
- Higher quality output
- Job enlargement
- Encourages teamwork among the work force
- Allows rapid style changeovers

**DISADVANTAGES:**

- Higher skilled cross-trained operators required
- Increased training time
- Idle equipment if machine is not needed for cycle
- Requires new supervisory skills, especially in the area of group dynamics
- Severely impacted by absenteeism, turnover, machine downtime

Some firms have designed other configurations which are variations on the Kanban theme. Work stations may be arranged in circles, or "Y" shape lines. Operators may be standing or sitting. The end results are what encourages experimentation in flexible manufacturing.

There are advantages and disadvantages of modular style manufacturing to be considered.

**ADVANTAGES:**

- Cooperation between management and employees
- Reduced manufacturing costs
- Minimal work in process
- Quick turn around of product
- Stimulate research for improving manufacturing processes
- Improved quality

**DISADVANTAGES:**

- Lack of supervisors trained in the skill areas needed; job enlargement; line balancing; garment construction; pattern development; group dynamics
- Lack of guidelines or shared information regarding successful methods of compensation
- Lack of experience by managers and other key personnel operating in this type of environment
- Severity of impact due to turnover, absenteeism, and lateness in the workplace



Modular line set-up.



Opposite view of same modular line set-up of above.

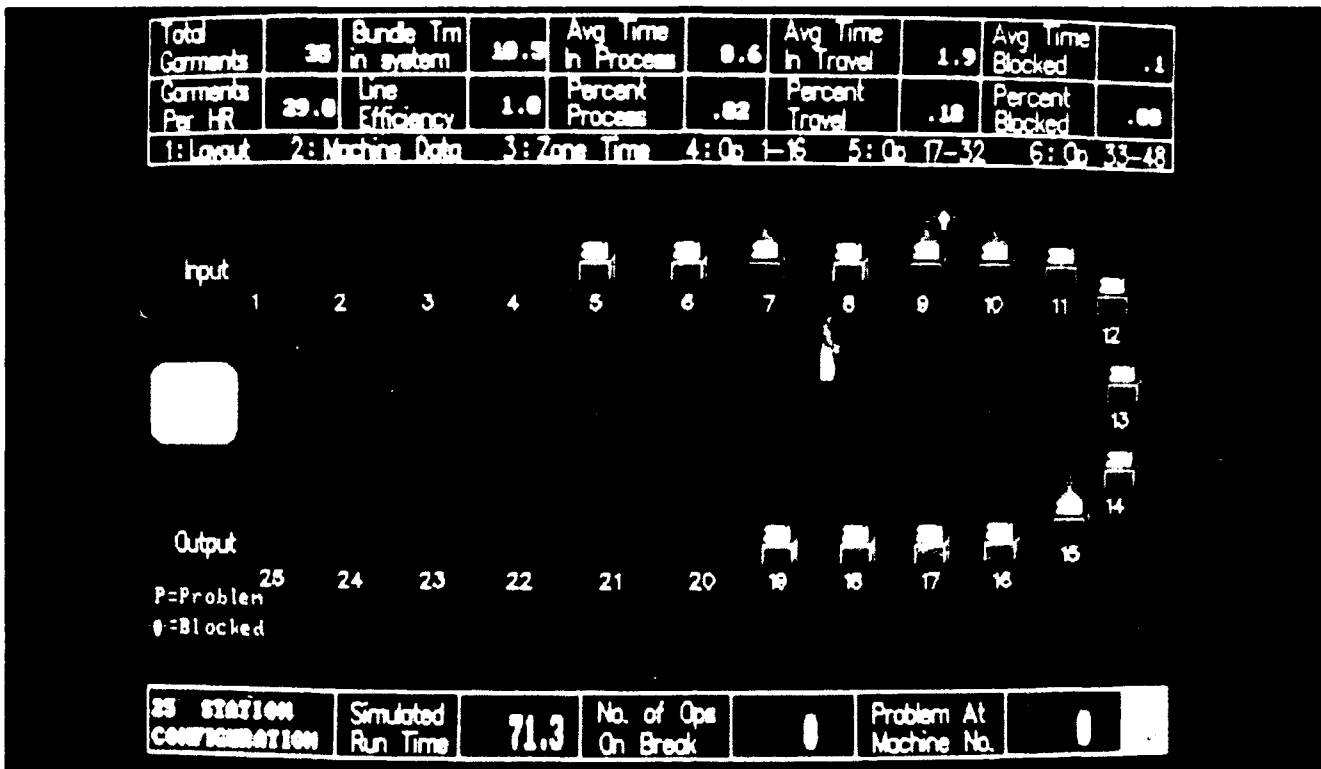

Simulation of a Modular Manufacturing Cell

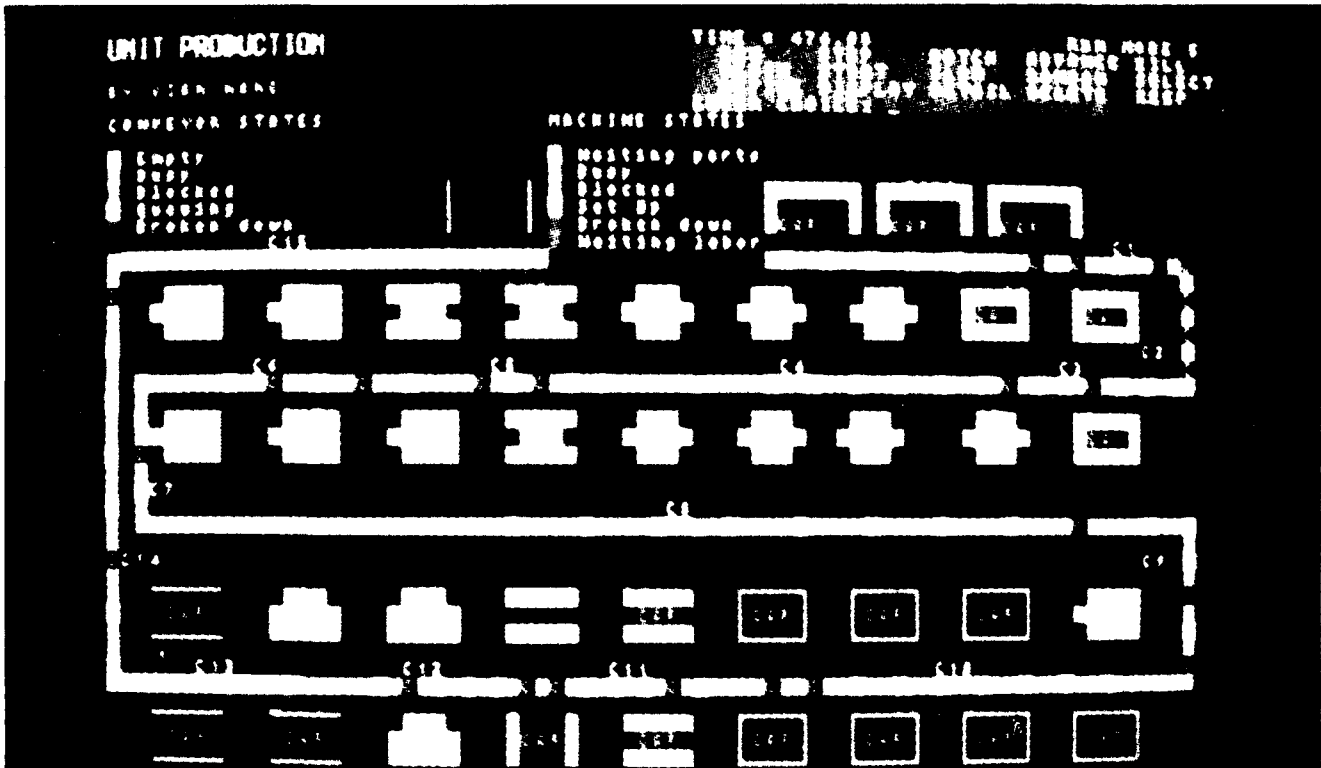

Simulation of a UPS.

Photographs and information courtesy of Textile Clothing Technology Corp. (TC) Raleigh, NC.

# SIMULATION

Computer simulation allows for the viewing of a manufacturing set-up or installation prior to actual implementation. Computer simulation can be used to plan a modular manufacturing set-up or to install unit production systems for the production of a garment, allowing manufacturers to gain flexibility.

Computer simulation allows a manufacturer who has not manufactured in a modular mode to do a "set-up". For the manufacturer who has had experience in modular manufacturing, simulation will project planned changes to an existing set-up.

Modular manufacturing may implement a real-time data collection system on a local area network with bar code reading and display terminals at the operator's workstation. Using the data collection system, a garment passing through a workstation records the information from the garment tag. The system displays operation cost, daily production target and any other data pertinent to the final outcome of the garment and team performance. A program offering both graphic simulation and data simulation allows for the quantifiable statistics to analyze the projected end result.

The information compiled to complete this book shows the list of operations and sequences in the assembling of the skirt. Depending on the manufacturing environment, each sequence varied slightly. However, the sequence information and data may be used for simulation programs. After loading information relevant to the style or garment into the data collection system, the program generates and displays available operations and machines and the list of required operators and machines for the production of the garment.

Through simulation a model may be developed to determine the number of machines and operators needed, as well as a configuration of the workstation for modular set-up and/or for unit production systems.





## **CHAPTER 8**

# **SUMMARY AND CONCLUSIONS**

The role of the designer in the development of apparel products which can be processed most efficiently through available production facilities has been illustrated by this handbook.

Designing with manufacturing and assembly in mind (DFMA) requires a systems approach which incorporates:

- △ Consideration of materials to be used and the ability of the plant to work with them
- △ Knowledge about the equipment and machinery available and how it works
- △ The organization of the production facilities and the flow of work through them
- △ Recognition of the skill levels of the plant production personnel
- △ Understanding of how the garment is to be constructed in production and the best sequence of operations
- △ Constant communications and coordination with other functions, from the earliest stages of product-line development, through the creative process, through the specification and pre-production engineering work, and within the adoption processes
- △ Feedback, from production and research personnel to the designer, of developments affecting design.

Knowledge of production capabilities may enable the designer to achieve a higher level of quality or have a garment adopted because the designer was able to bring the cost of the desired garment down within parameters dictated by marketing considerations. This approach to designing which connects the design function to production facilities enables the designer to quickly make revisions or create new styles in response to ever-changing market demands. Understanding **DESIGNING FOR MANUFACTURING AND ASSEMBLY** will expand the designer's creative opportunities rather than inhibit them.

## **IDENTIFICATION OF PRODUCTION FACILITIES**

Typical production settings and the equipment within these operations have been described for the production of the demonstration skirt via this handbook.

Plant facilities have been discretely classified on the basis of type of equipment and systems as:

- Sample Room - Sample Development**
- Traditional Plant - Conventional Plant**
- Automated Plant - Advanced Manufacturing Plant**
- Custom Clothier**
- Made-to-Measure Operation**
- Flexible Manufacturing**

It should be noted that the advanced plant may evolve from the more traditional plant, with automated equipment gradually placed within various operations. Furthermore, Made-to-Measure apparel can be produced in a plant with advanced equipment, and even the Custom Clothier may have mechanized equipment.

Since any facility may be a blending of conventional and advanced equipment and procedures, it is imperative that designers become familiar with the particular facility where their styles will be produced and make appropriate adjustments as illustrated in the development of the sample skirt used in this handbook.

This handbook was not intended to advocate any one type or system of manufacturing or to promote the acquisition of advanced systems. However, it does encourage the designer to understand the capability of the production facilities which will manufacture their garment and to modify the garment to most effectively utilize those facilities in order to:

- Achieve optimum efficiency**
- Be cost effective so that the garment can be adopted for sale**
- Produce required quality**
- Provide customer service**
- Target a specific market and customer**

When the designer understands the capability of the production facilities, the designer will be in a position to recommend equipment which will advance the manufacturing potential of the company. Also, the designer can help evaluate contracting plants for their ability to correctly produce the adopted styles.

Although this handbook is not intended to promote advanced technology or any one type of facility, many plants around the world, even smaller ones, are adding more automatic and flexible equipment and systems to remain competitive. Therefore, it is essential for the designer to acquire an understanding of these operations and to emphasize their use.

A review of some of the specialized equipment and systems the designer may find available, and brief explanations of their importance to the designer, are contained in the following "mini glossary".

### **CAD-CAM Systems:**

#### **(CAD) Computer Aided Design**

Enables the designer to sketch on the screen, apply a wide variety of fabrics to the original style, and try out many color combinations, very quickly.

Provides an easy way to adjust basic or designers' patterns, to create an altered part or style, or to accommodate production equipment.

Can enhance, rather than inhibit, designers creativity by permitting many alternatives to be considered. The first sketch could be done on paper and transferred to the computer screen for consideration of alternatives of styling, fabrics, and colors.

May provide quick cost comparisons for alternative styling.

May encourage use of standard parts from a style library in a wide variety of configurations for creative styling. This will facilitate the use of advanced equipment because of fewer machine adjustments and less retraining within the production operations.

#### **(CAM) Computer Aided Manufacturing**

Applies to use of computers in preparation for cutting, for actual cutting of fabrics, for sewing and finishing operations, for directing the flow of work through the plant via conveyor systems, and for other operations within the production and distribution complex.

Used for planning and controlling production and materials.

Relates to Computer Integrated Manufacturing to connect between machines, with further integration with the design and preparatory functions.

Some current applications of CAM include:

- Computerized pattern grading
- Computer assisted marker making
- Computer controlled cutting using knives or lasers
- Computer controlled Unit Production Systems (UPS).

CAM benefits to the designer include the following:

Greater accuracy on small parts through computerized cutting, which may encourage further use of decorative elements to enhance design of garments

Quicker check of production patterns to assure correct sizing or to quickly determine need for alteration of the original pattern

Ability to revise styling in response to market reaction because of flexibility and ease of changes in production.

#### **AUTOMATED PLANT EQUIPMENT THAT MAY BE USED:**

##### **Profile stitchers**

Are machines which can sew contours in a fixed path automatically. Generally they perform only one type of operation such as pocket setting on shirts and can only be adjusted for sizes or minor changes in shape. Included in this machine type are machines which:

- Run stitch top and bottom plies and lining for cuffs or collars
- Apply pockets to shirts
- Apply patch pockets to pants
- Sew shirt sleeve plackets or vents

The material usually is placed into holding devices manually, and the machine then sews automatically and stacks the part automatically.

The designer can facilitate efficient use of this type of equipment by specifying standard shapes and sizes wherever aesthetics of the design permit.

##### **Contour seamer**

Similar in concept to profile stitchers but tend to follow the outside contours of the part. May be used for joining or serging long runs, for example, skirt seams, pant legs, sleeve seams. Shape of curves in pattern may affect the operation of the machine. The designer would also consider optimum seam allowance.

**PROM - Programmable Read Only Memory**

These are cassettes used with sewing machines controlled by micro-processors which automatically sew a decorative design pattern while joining parts. May also be used for decorative stitching on a single part. Stitch configuration is easily changed by inserting a different cassette. (Preparation of the cassette is a separate operation which must be anticipated by the designer as production is planned).

This equipment can be used by the designer to enhance a style with more elaborate decorative stitching.

**Stitchless joining**

Joining parts or edge finishing without use of needle and thread. Includes ultra-sonics, adhesives, and meltable thread.

Designers may affect use of these techniques by choice of fabrics and finishes. For example, ultra-sonics require a high content of synthetic fibers in the fabric since the sound waves create heat to melt and fuse the fibers. Use of stitchless joining may substantially reduce costs and therefore help the designer to bring out a style that meets price limitations.

**Fusibles**

Adhesive coated interfacings or interlinings that are applied to shell fabrics with heat and pressure.

Designers must be sure that choice of interfacing and interlining are compatible with the shell fabric with regard to shrinkage and care. Use of fusibles in design give opportunities for cost savings in manufacturing and may actually improve quality.

**Special machines and attachments**

Designers alert to the availability of machines which produce decorative stitching open up wider opportunities for variety in their apparel. For example, there are special overedge machines which produce shell stitching and picot edges. Rufflers and similar attachments also are useful in designing for manufacturing.

**Flexible manufacturing**

As pointed out in Chapter 7, flexible manufacturing systems enable the designer to quickly respond to market demands and to make revisions more easily. More extensive creative opportunities are opened up compared with the constraints of static production facilities and systems.

**Flexible manufacturing systems**

"Ability to produce small quantities of many different items within cost structure that is competitive within the international labor market place."<sup>1</sup>

**FLEXIBLE MANUFACTURING SYSTEMS MAY INCLUDE:****Programmable automatic sewing machines**

Equipment which is not confined to a fixed path (as with profile stitchers), and may use robotics for flexible manipulation of materials through joining operations or parts production.

**Unit Production Systems (UPS)**

Conveyor systems which quickly move parts and sub-assemblies through production operations one-at-a-time. Flow can be controlled by computer programs, and movement readily changed between operators and operations without following a fixed path through the plant.

Cycles times are drastically reduced and work in process inventories minimized since there is little work queued behind each operation. Quality problems are fed back quickly so that a complete lot is not made incorrectly at one operation before it is discovered at a subsequent point.

**MODULAR PRODUCTION UNIT (MPU)**

"A modular production unit is a contained manageable work unit of four to seventeen people performing a measurable task. The operators are interchangeable among tasks within the group to the extent practical, and incentive compensation is based upon the team output of first quality products."<sup>2</sup>

Designers may benefit from "Modular Work Teams" because they add to the flexibility of manufacturing, they more quickly discover problems related to the design and construction of the garment, and they are motivated to suggest changes and solutions. Revisions of the garments tuned to market response can be made more easily and quickly.

<sup>1</sup> Department of Congress Study

<sup>2</sup> ARC Notes-Apparel Research Committee of AAMA, Vol 8, No. 5, Sept., 1989.

## **EFFECT OF DESIGN ROOM OPERATIONS ON MANUFACTURING EFFICIENCY**

**Efficient operation of the design and sample room operations also contribute to the efficiency of manufacturing and assembly:**

**Strict adherence to timetables (merchandise calendars) for product line development helps manufacturing to plan and organize equipment, labor, and material resources more efficiently and timely.**

**Production of duplicate samples for the sales force, showrooms, and buying offices can be timely. Feedback on potential production problems and early corrections in design and construction can be made, therefore avoiding delays and problems on production runs or elimination of the designers' creation from the product line. This includes the early decision and anticipation of need for duplicate sample yardage to assure its availability from the fabric supplier.**

**Early decisions on color combinations to permit timely purchases of matching trims and thread.**

**Clear, orderly input for specifications. For example, sources of fabric and trim used for a sample garment should be noted immediately on a design spec sheet traveling with the original garment so that confusion and hectic, time consuming searches are avoided.**

**Detailed specifications greatly assist the efficient preparation of cost estimates, purchases of materials, and accurate production in the manufacturing facility.**

## **ROLE OF MATERIALS IN DESIGNING FOR MANUFACTURING AND ASSEMBLY**

**Selection and use of fabric and trims play a vital role in designing for manufacturing. Designers' decisions can affect the utilization of materials, either increasing or decreasing costs. And the characteristics of the selected fabrics, such as, "hand", draping qualities, and openness of weave, as well as, shape and size of pattern parts can affect the efficient operation of machinery. Prints and geometrics may limit the use of equipment.**

**Decisions made by designers which may affect material utilization include:**

Choice of symmetrical vs asymmetrical patterned fabrics or fabrics with naps. Pattern parts for asymmetrical fabrics must be marked and cut all one way, which usually requires more material per garment since the pattern parts cannot be interlocked as closely for cutting, as they might be if the pattern could be placed either way in the marker used for cutting.

Whether the garment is symmetrical vs asymmetrical (left side differs from right side) can affect cutting room costs such as spreading and cutting, and might affect fabric utilization.

The shape, size, and number of parts affect material utilization. For example, shortening or re-shaping a curve on the end of a part might allow the part to be placed closer to another part in the marker, thereby reducing waste. Sometimes breaking down a garment section into two parts, instead of one, reduces fabric waste and eases assembly even though an extra sewing operation may be required.

Cutting on the bias uses more fabric than cutting on "the straight", and bias binding using shell fabric requires extra preparatory operations.

Seam allowances, also affecting part size, affects material utilization, as illustrated via the sample skirt.

Width of fabric.

**Some ways that characteristics of fabrics and trims selected by the designer may affect manufacturing equipment:**

Open weave fabrics may not allow automatic pick-up mechanisms to work consistently.

Slippery fabric may be difficult to spread or to cut accurately.

Small parts may not be cut accurately unless die-cutting or computerized cutting is available.

Goods may be too wide for available cutting tables.

The designer should keep in mind these potential constraints, as well as opportunities to find ways to reduce costs, so that a design can be adopted for sale within market price limitations. However, these considerations should not necessarily restrain the designer from a decision to use materials or patterns that result in higher costs and lower efficiencies. Market considerations should prevail.



## HOW TO ACQUIRE KNOWLEDGE OF EQUIPMENT AND SYSTEMS

**The designer can become familiar with specialized equipment and systems by :**

**Plant visits of company-owned and contracting plants.**

**Frequent consultations with production personnel and product and industrial engineers who do garment breakdowns for selection of machines, attachments, sequence of operations, and cost estimation. These discussions should be held as the product line is planned and throughout the line development.**

**Attendance at equipment shows such as, the annual "Bobbin Show" in Atlanta, Georgia where equipment and systems from all over the world are demonstrated. Similar equipment exhibitions are held in Japan and Germany.**

**Visits to show rooms and demonstration labs of equipment and systems companies. Some companies have problem-solving laboratories that are available to designers.**

**College Degree Programs and courses in Apparel Manufacturing are available at:**

**Clemson University, Clemson, SC. \***

**Fashion Institute of Technology, New York, NY. \***

**North Carolina State University, Raleigh, NC.**

**Philadelphia College of Textiles & Science, Philadelphia, PA.**

**Southern College of Technology, Marietta, GA.**

**Associated with Georgia Institute of Technology, Atlanta, GA. \***

**University of Southern Louisiana, Lafayette, LA. \***

**Other universities such as Wisconsin and Colorado State offer related courses.**

**\* Have a demonstration laboratory.**

