

**Intermediate Vocational Course
First Year**

GARMENT MAKING

For the course of Fashion and Garment Making

State Institute of Vocational Education

Directorate of Intermediate Education

Govt of Andhra Pradesh

Hyderabad

2005

Author

Dr. I. Rajitha

M. Sc., Ph.D (Textiles & Clothing)

Faculty, Dept. of Apparel and Textiles

College of Home Science, Saifabad, Hyderabad-4

Editor

Miss. P. M. Geetha

M. Sc., (Textiles & Clothing)

Head of the Department of Garment Technology

Kamala Nehru Polytechnic for Women, Hyderabad

CONTENTS

S. No.	Topics	Page
	Introduction	1
1.	Sewing Machine Types	2-8
	1.1 <i>Types of sewing machines</i>	2
	1.2 <i>Parts of a sewing machine and their functions</i>	3
	1.3 <i>Preparation for stitching</i>	5
	1.4 <i>Common machine troubles</i>	6
	1.5 <i>Care and use of sewing machines</i>	7
2.	Tools Used In Garment Construction	9-16
	2.1 <i>Sewing and embroidery tools</i>	9
	2.2 <i>Cutting tools</i>	10
	2.3 <i>Measuring tools</i>	12
	2.4 <i>Marking tools</i>	14
	2.5 <i>Pressing tools</i>	14
	2.6 <i>Miscellaneous tools</i>	15
3.	Paper Patterns	17-19
	3.1 <i>Types of paper patterns</i>	17
	3.2 <i>Contents of paper patterns</i>	18
	3.3 <i>Uses of paper patterns</i>	19
4.	Stitches, Seams and Seam Finishes	20-32
	4.1 <i>Hand Sewing Techniques</i>	20
	4.1.1 <i>Temporary Stitches</i>	20
	4.1.2 <i>Permanent Stitches</i>	21
	4.2 <i>Seams</i>	23
	4.3 <i>Seam Finishes</i>	29

5.	Fullness	33-41
	5.1 Tucks	33
	5.2 Pleats	35
	5.3 Gathers	36
	5.4 Shirring or Gauging	37
	5.5 Smocking	38
	5.7 Godets	41
6.	Plackets	42-46
	6.1 Inconspicuous Plackets	42
	6.2 Conspicuous Openings and Plackets	44
7.	Necklines	47-51
	7.1 Different methods of finishing necklines	47
	7.2 Facings	48
	7.3 Binding	50
8.	Fasteners	52-58
	8.1 Hooks And Eyes	52
	8.2 Thread Eyes / Loops	53
	8.3 Buttons	54
	8.4 Button Holes	56
9.	Body Measurements	59-64
	9.1 Points considered while taking Measurements	59
	9.2 Equipments required for measuring	60
	9.3 Where and how to take measurements	60
	9.4 Measurement Chart for Bodice and Skirt	63
10.	Bibliography	65

GARMENT MAKING

Introduction

This part of the course introduces the students to the skills required for converting fabrics into a sewn garment. It is a very important skill that gives hands-on experience in garment assembly. Garment making is an introduction to the basic skill of sewing which is essential to convert the design on paper into a garment.

Garment making is one of the basic content of fashion designing. Proficiency in the art of sewing is an essential pre-requisite in garment making. Therefore, it is necessary to know the techniques of sewing for producing attractive garments with good fit. Garment making is thus a technical accomplishment that requires knowledge of fabrics, principles of clothing construction and skills involved in it. This depends on the ability to select the correct fabric, colour, design and accessories to suit an individual occasion. A garment that is made will be attractive if it fits well and proper attention is paid to its finer details.

1.0 SEWING MACHINE TYPES

Introduction

Sewing is a creative and interesting skill. The knowledge of sewing give a confident feeling when it is applied to the construction of garments. The earlier method of sewing by hand is not applicable for all stages of garment making. Therefore, considerable emphasis is given to machine sewing. There are several machines in the market today, each with its own desirable features and advantages. Sewing machines range from most basic having only simple lock stitch to the electronic machines that use advanced computer technology having various functions for example piping, binding, ruffling, pleating, darning, hemming and even making buttonholes and attaching fasteners. A good sewing machine is required to obtain quality products. One has to be familiar with the characteristics of different types of machines for selecting appropriate machine, depending upon the ability and requirements of the person.

1.1 TYPES OF SEWING MACHINES:

Sewing machines are now available in various models such as domestic model, tailor model, industrial model, portable and cabinet models. They may be operated by hand, treadle or electric motor.

Hand – Operated Sewing Machine:

This is the simplest form of sewing machine which is operated by hand. A detachable handle provided to the flywheel is used to operate the machine. This machine is generally suitable for domestic purpose because it does not help in speeding up the work.

Treadle Sewing Machine:

This machine is exactly like the hand sewing machine but it is operated by foot using an additional stand. In this type the balance wheel is operated by a belt with the help of lower stand, which is driven by feet. This machine operates faster than that of the hand-operated machine. This machine is suitable where there is no power supply. When handling this machine both the hands are free to handle the fabric, speeding up the work. Even some of the heavy-duty machines are operated by this method.

Electric Sewing Machine:

This is the fastest sewing machine. One needs practice to handle it. In an electric machine the balance wheel comes to motion by a belt, which is attached to an electric motor.

1.2 PARTS OF A SEWING MACHINE AND THEIR FUNCTIONS:

The basic structure of sewing machine is the same whether it is hand-operated sewing, treadle sewing machine or electric sewing machine. The basic parts of a sewing are listed below and seen in Fig.1

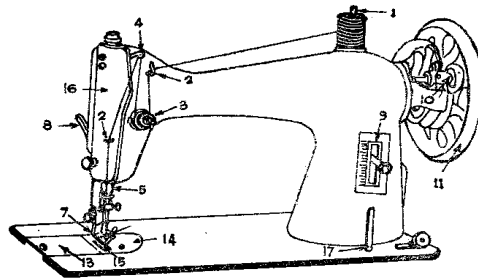

Fig. 1 Parts of a Sewing Machine

1. **Spool pin:** It is fitted on top of the arm to hold the reel.
2. **Thread guide:** It holds the thread in position from the spool to the needle.
3. **Tension disc:** The two concave discs put together with the convex sides facing each other. The thread passes between the two. The tension of the thread is adjusted by a spring and nut which increases or decreases pressure
4. **Take up lever:** It is a lever fitted to the body of the arm. Its up and down motion feeds the thread to the needle and tightens the loop formed by the shuttle.
5. **Needle bar:** This is a steel rod to hold the needle at one end with the help of a clamp. Its main function is to give motion to the needle.

6. **Bobbin case:** This moves into position to catch the top thread and form the stitch as the needle is lowered into the bobbin chamber.
7. **Presser foot:** It is fixed to the presser bar to hold the cloth firmly in position when lowered.
8. **Presser foot lifter:** A lever attached to the presser bar for raising and lowering the presser foot.
9. **Stitch regulator:** This controls the length of the stitch.
10. **Bobbin winder:** A simple mechanism used for winding thread on the bobbin.
11. **Fly Wheel:** When this is made to revolve, it works the mechanism of the motion
12. **Clutch or Thumb Screw:** This is in the center of the fly wheel and it engages and disengages the stitching mechanism.
13. **Slide Plate:** A rectangular plate, which facilitates the removal of the bobbin case without lifting the machine.
14. **Needle Plate or Throat Plate:** A semi-circular disc with a hole to allow the needle to pass through it.
15. **Feed dog:** This consists of a set of teeth fitted below the needle plate. It helps to move the cloth forward while sewing.
16. **Face plate:** A cover which on removal gives access to the oiling points on the needle bar, presser bar and take-up lever.
17. **Spool pin for bobbin winding:** Spool of thread is placed on this at the time of bobbin winding.

1.3 PREPARATION FOR STITCHING

Before starting actual machining, you should check that the needle of the machine is of correct size, is sharp and correctly set. The bobbin should be evenly set. Briefly, the various steps of pre-preparation are:

- Winding the bobbin
- Upper Threading
- Drawing the bobbin thread
- Tension adjustments
- Pressure and feed adjustments
- Selection of thread and needle

A perfect stitch can be obtained only when the thread selected is suitable to the material to be stitched and the needle is of the correct size. For stitching on delicate thin fabrics, use fine thread and fine needle. For heavy fabrics, needles and thread size should be larger. The following Table 1 will be a guide to help selection of appropriate needle and thread sizes.

Table 1: Selection of thread and needles for fabrics

Fabric	Fiber	Thread	Needle	Stitch length
Finely Woven	Synthetic., cotton & blends	synthetic 60 m ercerized 50	9 -11	10-15
Light weight woven	Synthetic., cotton & blends	synthetic 60 m ercerized 50	11-14	12-15
Medium weight woven	Synthetic., cotton & blends	synthetic 60 m ercerized 50	11-14	12-15
Heavy weight woven	Synthetic., cotton & blends	synthetic 60 m ercerized 50	16-18 14	10-12

Types of Threads

The natural fibre threads available in the market are cotton and silk. Synthetic threads are usually made from polyester and terylene. Threads whether natural or synthetic are produced in various thickness: higher the number, finer is the thread and smaller the number, coarser is the thread. It is important to remember that the same thread should be used for the bobbin and top spool.

Selection of needles

Machine needles are selected according to the weight and other characteristics of the fabric, as well as the thread type being used for construction. Generally, a needle should be fine enough to penetrate the fabric without damaging it and yet have an eye, which is big enough so that the thread does not fray or break. Needles come in various sizes, from very fine (size 9) for light weight fabrics to thick (size 18) for very heavy weight and dense fabrics.

1.4 COMMON MACHINE TROUBLES

The sewing like any other machine, gives troubles of stitching like thread breaking, uneven stitching, puckering, bending and breaking of needle, looping of threads, skipping of stitches, etc. Little problems with the sewing machine can be very irritating and time consuming. They can happen to even the most experienced seamstress.

A person operating the machine should be able to rectify these and solve the problems. Some of the common machine problems are listed below:

- breaking needles
- looping of stitches
- skipping stitches
- variation in stitch length
- puckered seams
- upper thread breaking
- lower thread breaking
- machine not feeding properly
- machine working heavily
- layers feed unevenly
- fabric does not feed in straight line
- cause damage to fabric
- Puckering on both layers of fabric
- Puckering on under layer only
- Shows feed marks on the under side
- Fabric is damaged or holes around the stitches

1.5 CARE AND USE OF SEWING MACHINES

A sewing machine needs care for its smooth running. It should be cleaned and oiled regularly to ensure satisfactory sewing and long life. When not in use, your machine should be covered to prevent dust accumulation on it. Use a small dry brush or old toothbrush and soft cloth to remove dust and lint. You should always remove lint deposits, dust and thread bits before oiling any part of the machine. Use a pointed instrument like a needle to pick out the bits of thread and lint that cannot be brushed out.

It is necessary to oil and lubricate the machine periodically. If the machine is used everyday, oil it once a week. After oiling, wipe off the surplus oil and place a piece of folded fabric under the presser foot to absorb any excess oil. To oil thoroughly, remove the upper thread, needle plate, slide plate, face plate, bobbin case, needle and presser foot. Oil the holes on the underside first, after cleaning and then proceed to the upper side. Use only few drops of oil in each hole. Never use coconut oil. Machine oil of different brands may be used for different models of sewing machine, but should be used as recommended in the instruction book.

If the machine becomes gummed with oil, put a drop of kerosene or petrol in each oil hole and joints and run it rapidly for several minutes. Wipe off and re-oil it with machine oil. The motor of electric sewing machine should be greased periodically.

Summary

The knowledge of sewing give a confident feeling when it is applied to the construction of garments. The various parts of a sewing machine and their functions helps one to understand the working of a sewing machine. A brief up on the common machine problems help us to understand and rectify the problems. Above all the care of sewing machine is rather important for a long service of the machine.

Short Answer Questions

1. What is the function of a tension disc?
2. What is feed dog?
3. What are the common sizes of needles used for sewing?
4. What are the steps of preparation before operating a sewing machine?
5. List out the common machine problems that may occur.

Essay Type Questions

1. What are the different types of sewing machines?
2. Give a brief account of the parts of a sewing machine and their functions.
3. What are some of the points for maintaining the machine in good working condition?

2. 0 TOOLS USED IN GARMENT CONSTRUCTION

Introduction

Besides a sewing machine in good condition, well selected sewing equipment and pressing equipment are essential for making garments of good quality and appearance. **Sewing box / kit:** First and foremost, one should have a box or basket with compartments for keeping the things needed for sewing.

2.1 SEWING AND EMBROIDERY TOOLS:

Hand Sewing Needles:

They are found in sizes from the very fine 9 to the heavy 18. The best quality needles are made of hand ground steel. For hand sewing medium length needles with a short oval eye is selected. Crewel needles designed for embroidery work have a long oval eye.

Sewing Machine Needles:

They are found in sizes from the fine 9 to the heavy 18. The needles are made to fit the specific make and model of each sewing machine. The needle size should conform to the weight, thickness, and kind of fabric.

Sewing thread:

With the wide and ever increasing range of fabrics available in the market, it is important to know the right sewing thread for the various types of fabrics. The right kind of thread is important in sewing as both the thread and the garment should share the same characteristics, as they have to be laundered and ironed together, they should shrink and stretch together.

Pins:

These come in different sizes for use in different fabrics. The right choice of pins is most essential for good workmanship, speed, and convenience in sewing. Use silk or stainless steel pins. The ball point pins are useful for fine knits. The other types of pins are *dressmaker* pin (a pin of medium diameter but quite suitable for most sewing needs),

and *silk* (a very slender pin with a needle point to be used on delicate fabrics).

Thimbles:

These are necessary for efficient and accurate hand sewing. A metal thimble should fit snugly on the middle finger of the needle holding hand. There are two types of thimbles: an open-ended thimble, preferred by tailors, and the more common closed-ended thimble, called the dressmakers thimble (Fig.2a).

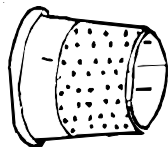

Fig. 2a Thimble

Embroidery Frame:

This is used for keeping the fabric stretched while the work is being carried out.

Embroidery Threads:

These are available in a variety of colours in six stranded skeins. One can use two or three strands at a time.

Stiletto:

This is a sharp pointed instrument for punching holes in material. It is used for forming holes in material. It is used for forming eyelets in belts and for embroidery work.

Bodkin:

This is a flat needle with a blunt end and a large eye for threading elastic and tape.

2.2 CUTTING TOOLS

The following types of shears and scissors are made for both right-handed and left-handed cutting. All cutting tools must be kept sharp, clean, and grease-free for accurate cuts.

Bent-Handle Shears:

They are 8 to 10 inches long (Fig. 2b). They are used for cutting all types of fabrics. Shears differ from scissors in that they have one small ring handle for the thumb and a large ring handle for the second, third and fourth finger.



Fig. 2b Bent handle shears

Scissors:

They are 5 to 6 inches long. They are used for light cutting, trimming, clipping corners, and cutting curves. These have round handles for both the blades. They are designed for snipping threads and trimming seams. They should be held so that the wider blade is above the narrower blade.



Fig. 2c Scissors

Pinking Shears:

They are 9 to 10 inches long (Fig. 2d). They produce a notched cutting line (zig zag) which gives a neat appearance to the inside of garments.



Fig. 2d Pinking shears

Button Hole Scissors:

These can be adjusted so as to cut button holes in any size required (Fig. 2e). They are useful if one needs to make many button holes

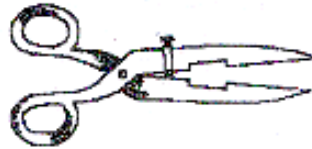

Fig. 2e Buttonhole scissors

Electric Scissors

These are used in most sample rooms. They are ideal for cutting silk, nylon, and soft, hard-to-cut fabric (Fig. 2f).



Fig. 2f Electric scissors

2.3 MEASURING TOOLS**Measuring Tape:**

It has a smooth surface that is clearly marked with increments of inches and centimeters on both sides. It is usually about $\frac{1}{2}$ inch to $\frac{1}{4}$ inch wide and 60 inches long, and has $\frac{1}{8}$ divisions (Fig. 2g). At one end of the tape is attached a brass strip about 3 inches long and at the other end, a small brass covering.

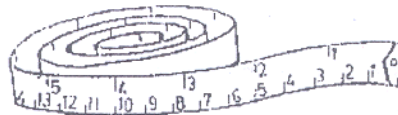

Fig. 2g Measuring tape

Rulers:

They are used in sample room which are either clear plastic or metal. It is useful to have 2 rulers: one is 1 inch wide and 6 inches long, and the second is 2 inches wide and 18 inches long.

Yardstick or meter scale:

It is available in 36 inches or 45 inches in length in wood or metal. They are useful for checking grain lines when fixing pattern pieces on material and for drawing long seam lines on fabric or paper.

L Square:

It is an L-shaped metal ruler; the long arm measures 24 inches, the short arm 14 inches. This has a perfect right angle corner and is used to draw lines at right angles at the time of drafting. It is helpful during the process of “straightening fabric” to check whether the corners of the fabric have got the right-angled structure

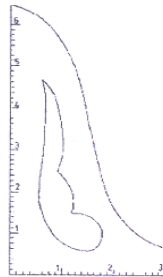

Fig.2h L-square

Skirt Marker:

They mark hem length accurately. Markers are adjustable and are available for use with chalk powder or pins. A six-inch gauge can be made of cardboard or bought from a shop (Fig. 2i). It is useful as a measuring guide for marking width of hems, pleats, seam allowances etc. accurately. Notches are provided at regular intervals along the gauge. One edge of the notch is at right angles to the straight. While measuring or marking, use the straight edge of the notch as a guide.

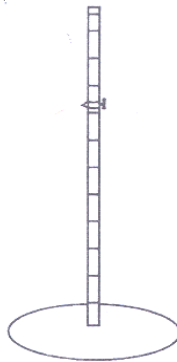

Fig. 2i Hem or skirt marker

2.4 MARKING TOOLS

Tracing Wheel:

It is used to transfer the pattern markings-including seams, darts and pocket placements to the wrong side of the fabric with the aid of tracing paper. The small *serrated edge* tracing wheel is appropriate for most fabrics (Fig.2j). A *smooth edge* tracing wheel is used on fine or knit fabrics to avoid snagging the yarns.

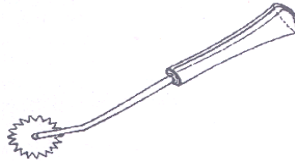

Fig. 2j Tracing wheel

Tracing Paper:

It is a wax-coated paper used with the tracing wheel to transfer pattern markings to the wrong side of the fabric

Tailors Chalk:

It is made of wax or stone chalk that is used to transfer markings to fabric when white carbon is not visible. Stone chalk is also available in pencil form. This is available in assorted colours and in rectangular or triangular shapes.

2.5 PRESSING TOOLS

Iron:

This keep an automatic iron handy for pressing fabric before cutting, during construction and after the garment is completed.

Steam Iron:

It has an adjustable temperature control, and is equipped with a thumb press for automatic steam. Distilled water is heated, and the resulting steam can be released with the thumb press while pressing.

Ironing Board:

It is used for hand pressing which is padded and of convenient height. One may use an ordinary table covered with sheet and blanket for this purpose.

Sleeve Board:

This is a well-padded miniature of a full-sized ironing board and is used to press sleeves and hard-to-reach small details (Fig. 2k). It has a tapered end on one side and a round end on the other side.

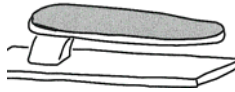

Fig.: 2k Sleeve Board

Press cloth:

Fabric used for press cloth should be colourfast and should be washed or boiled to remove all sizing.

2.6 MISCELLANEOUS TOOLS

Awl:

It is a small, sharp-pointed tool used to punch small, round holes for marking on paper or leathers.



Fig. 2l Awl

Seam Ripper:

It is used to remove basting stitches and to rip out unnecessary machine stitches (Fig. 2m).



Fig. 2m Seam ripper

Loop Turner:

Is a long wire with a latch hook, used for turning bias strips to make spaghetti straps and narrow belts.

Dress Form:

This is a padded form of body and may be made of wood, cardboard, plaster of paris, reinforced plastic. This is a necessity in all sample rooms for designing and fittings.

Paper:

It is for pattern making purposes and fabric cutting. This soft

paper comes in rolls of plain paper or paper with blue dots or other markings at set intervals.

Three-Way Mirror: It is used for model fittings.

Orange-stick:

This is a long tool whose point can be inserted into the corners of collars, seams, etc., so as to give a neat pointed appearance.

Cutting board or table:

This is a table of convenient height and size is a definite aid in cutting and constructing garments. 5' x 3' is a desirable size with 2" x 6" height.

Summary

A variety of tools and equipment are used for performing various functions such as sewing, cutting, measuring, pressing, etc. A knowledge about these tools will help us to choose the right tool to complete a particular task in the process of garment construction.

Short Answer Questions

1. What is stiletto?
2. What is purpose of bodkin?
3. What is the purpose of hip curve
4. What is the purpose of a seam ripper?
5. What is a dress form?

Essay Type Questions

1. List out the tools that you will choose for embroidery work.
2. What are the different types of cutting tools used in the sewing process?
3. Write about the different measuring equipments used.
4. What are the various marking tools used ?
5. What are the other miscellaneous equipment used in the process of sewing?

3.0 PAPER PATTERNS

Introduction

Pattern of a garment is the blue print on the basis of the fabric is cut. The patterns can be prepared using strong brown papers, news papers for rough drafts, strong white paper which is available in a variety of weights and widths, tracing paper or butter paper may be used to develop patterns. A basic pattern of a garment can be prepared by one of these two methods:

- by drafting
- by draping fabric on a model or person concerned

Drafting may be defined as a system of drawing patterns on paper with mechanical precision, on the basis of body measurements. The basic pattern developed on paper may be modified to develop patterns for varied styles. This is also called as flat pattern designing. This is sometimes called as the third type of preparing patterns that is rather imprecise. The basic pattern is also referred to as sloper, block, master or foundation pattern.

3.1 TYPES OF PAPER PATTERNS:

Paper patterns are made and or available in two types – commercial patterns prepared on the bases of standard measurements and patterns drafted using personal measurements.

1. Commercial Patterns:

Commercial patterns are usually done on tissue paper. Since tissue paper is not bulky, it allows many pieces of pattern to be packed compactly in an envelope. Good patterns are carefully labeled with the following information: pattern size, name of each pattern (back, front, sleeve, etc), number of pieces to cut from each pattern piece, pattern markings like notches, buttons and button hole position, seam allowances, grain lines, center front, center back, hem line markings, dart locations, etc. Some companies even give markings for pattern alteration locations. In addition instruction sheets explaining steps involved in using the pattern, to cut the garment, method of cutting specific fabrics with different textures and print, method of construction and fabric suitability.

Commercial patterns for women and children are usually sized according to bust measurements. Pants and skirts according to waist, hip and length measurements. Hence before selecting the patterns, you should take the body measurements accurately and buy the correct size. The measurements are listed on the pattern envelope in some of the good commercial patterns.

2. Patterns Drafted with Personal Measurements:

In many ways it is most advantageous to draft your own patterns rather than buy commercial patterns. It is most economical, since drafting's based on personal measurements fit well.

3.2 CONTENTS OF PAPER PATTERNS

A paper pattern should contain the following information as given in Fig. 3a below:

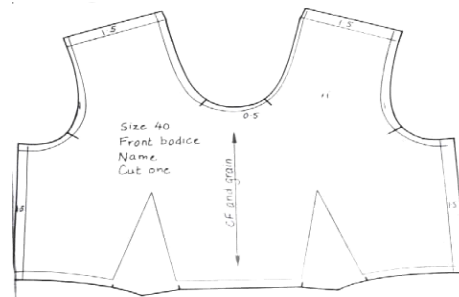

Fig. 3a Paper Pattern

- Name of the block e.g bodice front, back, sleeve, skirt, collar, yoke, pocket, etc.
- Grain line on each pattern piece
- Size e.g. 32, 34, 36, 38, etc
- Centre Front or Centre Back
- Style number or code number of the pattern
- Pattern piece e.g skirt front or back
- Cutting information – how many pieces to be cut e.g cut 1, cut 2, cut on fold.
- Notches – marks needed to help in assembling of garment sections
- Amount of seam allowances

3.3 USES OF PAPER PATTERNS

The paper patterns for various styles can be prepared and stored easily. The basic pattern with alterations at points can be prepared which later can be used to develop other styles. A number of styles can be developed in a short time and used comfortably even if the person using paper patterns do not have any idea of drafting patterns. They are the cheapest ways of designing used for constructing garments of varied styles.

Summary

Pattern making opens scope for developing an infinite variety of styles both regular designs and fantasy patterns. Pattern making largely depend upon fashion during that period. A paper pattern help in garment construction process and give a correct fit if properly drafted.

Short Answer Questions

1. What is drafting?
2. What is a sloper?
3. What is a notch and its use in garment construction?
4. What are the two methods used for developing a pattern?

Essay Type Questions

1. List out the contents of a paper pattern with the help of a figure.
2. What is a commercial pattern and discuss about the contents of a commercial pattern?
3. Write the difference between commercial pattern and patterns developed by using personal measurements.

4.0 STITCHES, SEAMS AND SEAM FINISHES

Introduction

Understanding garment making and regular knowledge of basic sewing techniques such as simple stitches, seams, darts, gathers and pleats etc. would enable appropriate application in garment construction. Before learning to stitch seam on the machine one must learn the basic hand stitches which are used in garment making. Basic hand sewing techniques are divided into constructive and decorative stitches. Constructive stitches are further divided into temporary and permanent.

4.1 HAND SEWING TECHNIQUES

4.1.1 TEMPORARY STITCHES:

Temporary stitches are used to hold the garment pieces together before permanent stitches are made. These are termed as tacking or basting stitches. They are often used to hold two or more layers of material together before the permanent stitches are made. Usually this stitch is horizontal and is worked from right to left with a knot. For tacking it is better to use a contrast colour thread. There are several types of basting stitches -

a. Even basting:

This is used for tacking seams and other details, which must be held securely. The stitches are of equal length about $\frac{1}{4}$ inch on both sides of the material. This is used for tacking seams and other details, which must be held securely (Fig.4.1a)

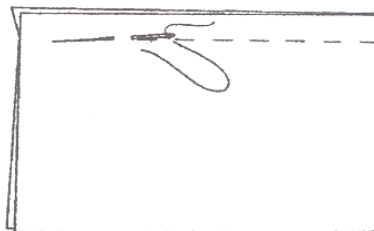

Fig. 4.1a Even basting

b. Uneven basting:

The stitch on the upper side of the fabric is at least twice than that on the under side. The size of the stitch is usually $\frac{1}{2}$ inch. Use this type of basting as guideline where there is little or no strain (Fig.4.1b).

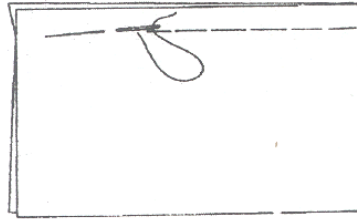

Fig. 4.1 b Uneven basting

4.1.2 PERMANENT STITCHES:

The stitches that are left in the garment and form a part of the stitched garment are permanent stitches. Knots are not generally used for starting the permanent stitches. Two or three stitches at the beginning of a row, especially on flat seams will be helpful in securing the stitches.

a. Running stitch:

This is the simplest form of hand stitch which is used for permanent sewing hand seams such as tucks, gathering, shirring, quilting and mending. It is similar to even basting, but the stitches are much similar. The stitches should be straight, fine and evenly spaced and about $\frac{1}{16}$ to $\frac{1}{8}$ inch in length. Pass the needle through the fabric several times before pulling it through (Fig. 4.1.2a).

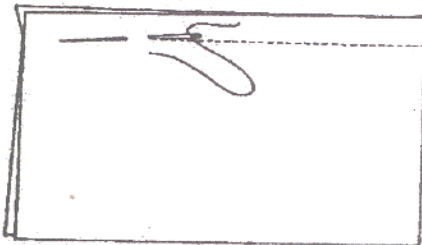

Fig. 4.1.2a Running stitch

b. Backstitch:

The backstitch is strong and is sometimes substituted for machine stitching. Stitches should be about 1/16 to 1/8 inch long on the topside. To make the backstitch, push needle up through the material at a point on the stitching line about 1/8 inch from its right end. Take a stitch inserting the needle 1/8 inch back of the thread at the beginning of the stitching line and bringing it out an equal distance in front of the thread. Repeat this way, keeping stitches uniform in size and fairly firm (Fig.4.1.2 b).

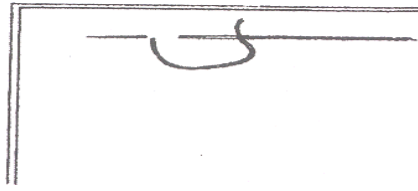

Fig. 4.1.2 b Back Stitching

c. Run and back or combination stitch:

In this a backstitch and three or four running stitches are combined and can be used for working plain seams done by hand. This stitch is faster than the backstitch and stronger than the running stitch.

d. Hemming:

This is used to secure down a folded edge of material like hems. Hemming appears as small slanting stitches on the wrong side and right side. The stitches should be fine and spaced close enough to hold the hem securely in place, but far enough apart to be inconspicuous from the right side of the garment. Before starting the hem, fasten the thread with several tiny stitches on top of each other. Finish off the hemming also with several stitches to fasten it securely. There are two types of hems – slip hemming and knotted hemming.

e. Slip hemming:

This is used for hems, facings or folds where invisibility is more important than strength. Fasten the thread beneath the hem, bringing the needle out through the edge of the fold. Take a tiny stitch in the garment directly beneath the point where the thread leaves the fold. Now insert the needle in the hem, slip it along inside the fold and bring it out again about 1/2 inch away. Repeat the stitch (Fig.4.1.2c).

f. Knotted hemming:

This is worked from right to left. A small vertical hem stitch is made such that the thread passes around the tip of the needle that on pulling the needle out forms a knot around the stitch made. Thus each stitch is fixed securely by means of a knot and therefore is very strong (Fig.4.1.2d).

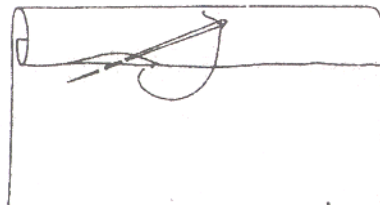

Fig. 4.1.2c Slip hemming

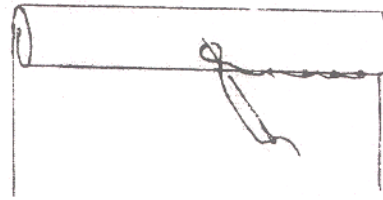

Fig. 4.1.2d Knotted hemming

4.2 SEAMS

A seam is a method of joining two or more pieces of materials together by a row of stitching. The purpose of most of these seams is purely functional and can be called as constructional seams. Seams should be as flat as possible and unseen except those that are used for decorative purposes for garment design and line.

Seams can be classified into flat seams and ridge seams. Plain seam and flat fell seam are examples of flat seams. Ridge seams include the French seam. Seams may also be divided into conspicuous and inconspicuous seams. Inconspicuous seams when finished will not have stitches seen on the right side of the garment, example are plain, corded and French. Conspicuous seams are those that have stitches seen on the right side of the garment like run and fell seam, lapped seam etc

a. Plain seam:

This is the most widely used seam which is pliable and inconspicuous. It is used on all types of fabrics except on very transparent kinds and is suitable for firm fabrics that do not ravel and will not be subjected to hard and frequent laundering. This is used for side seams, under arm .

seams and armhole seams. Place the two pieces of fabrics to be joined together right sides facing. Work a line of tacking stitches on the seam line and machine (Fig.4-2a)

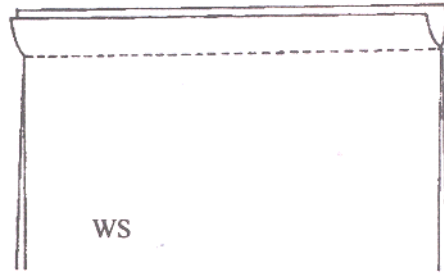

Fig. 4-1.2b Back stitching

c. Run and back or combination stitch:

In this a backstitch and three or four running stitches are combined and can be used for working plain seams done by hand. This stitch is faster than the backstitch and stronger than the running stitch.

d. Hemming:

This is used to secure down a folded edge of material like hems. Hemming appears as small slanting stitches on the wrong side and right side. The stitches should be fine and spaced close enough to hold the hem securely in place, but far enough apart to be inconspicuous from the right side of the garment. Before starting the hem, fasten the thread with several tiny stitches on top of each other. Finish off the hemming also with several stitches to fasten it securely. There are two types of hems – slip hemming and knotted hemming.

e. Slip hemming:

This is used for hems, facings or folds where invisibility is more important than strength. Fasten the thread beneath the hem, bringing the needle out through the edge of the fold. Take a tiny stitch in the garment

directly beneath the point where the thread leaves the fold. Now insert the needle in the hem, slip it along inside the fold and bring it out again about $\frac{1}{2}$ inch away. Repeat the stitch (Fig.4.1.2c).

f. Knotted hemming:

This is worked from right to left. A small vertical hem stitch is made such that the thread passes around the tip of the needle that on pulling the needle out forms a knot around the stitch made. Thus each stitch is fixed securely by means of a knot and therefore is very strong (Fig.4.1.2d).

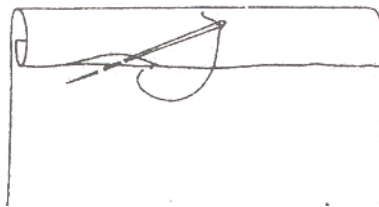

Fig. 4.1.2c Slip hemming

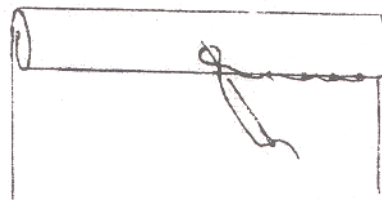

Fig. 4-1.2d Knotted hemming

4.2 SEAMS

A seam is a method of joining two or more pieces of materials together by a row of stitching. The purpose of most of these seams is purely functional and can be called as constructional seams. Seams should be as flat as possible and unseen except those that are used for decorative purposes for garment design and line.

Seams can be classified into flat seams and ridge seams. Plain seam and flat fell seam are examples of flat seams. Ridge seams include the French seam. Seams may also be divided into conspicuous and inconspicuous seams. Inconspicuous seams when finished will not have stitches seen on the right side of the garment, example are plain, corded and French. Conspicuous seams are those that have stitches seen on the right side of the garment like run and fell seam, lapped seam etc

a. Plain seam:

This is the most widely used seam which is pliable and inconspicuous. It is used on all types of fabrics except on very transparent kinds and is suitable for firm fabrics that do not ravel and will not be subjected to hard and frequent laundering. This is used for side seams, under arm seams and armhole seams. Place the two pieces of fabrics to be joined together right sides facing. Work a line of tacking stitches on the seam line and machine (Fig.4.2a).

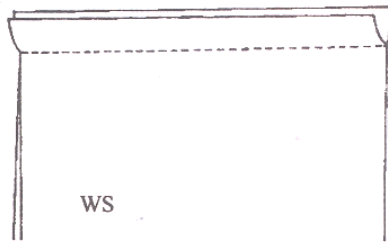
**Fig. 4.2a Plain seam****b. Lapped seam:**

This seam is commonly used for joining a gathered or unaltered section to a straight edge as in a yoke. Take the part of the which is to be laid on top and turn its seam allowance to the wrong side. Place this piece on the top of the second piece, right sides facing and matching the fold to the seam line. Tack in position and machine close to the folded edge (Fig.4.2b).

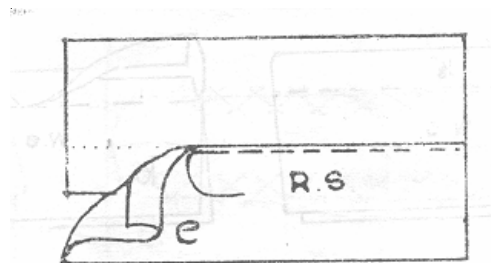
**Fig. 4.2b Lapped seam**

c. French seam:

This is a ridge seam and is used on transparent and light weight fabrics, especially on baby clothes and delicate blouses. It is a neat and durable finish as the raw edges are completely enclosed (Fig.4.2c). It is a neat and durable finish as the raw edges are completely enclosed. The two pieces of materials to be joined are placed together with wrong sides facing. Work a row of stitching $1/8$ inch. Press the seam and turn the work so that the right sides are together. Crease the first row of stitching so that it is directly on the edge. Tack and stitch along the seam line about $1/8$ inch from the fold.

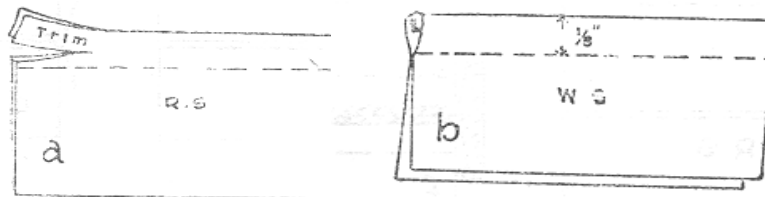
**Fig. 4.2 c French Seam****d. Flat and fell seam:**

This is a flat durable seam used on men's sports shirts, work clothes and children's clothes and pyjamas. Places the pieces to be joined wrong sides facing and stitch on the seam line. Press both seam allowances together in the same direction and trim the under seam to $1/8$ inch and the upper one to $3/8$ inch. Turn under the raw edge of the wide seam allowance so as to make a smooth fold $1/4$ inch wide. Machine stitch close to the folded edge on the right of the garment. The right side of the seam will show two rows of stitching and wrong side will show only one row of stitching (Fig.4-2d).

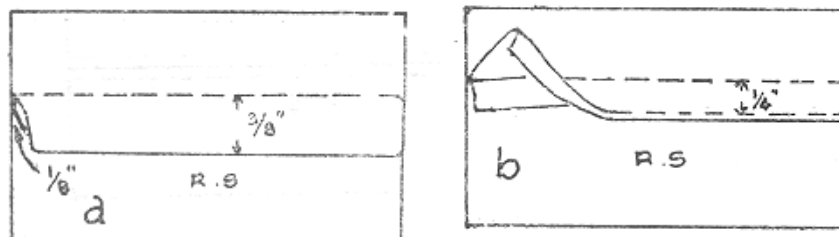
**Fig.4-2d Flat fell seam**

e. Bound seam:

This seam is formed by folding a separate binding strip over one or more plies of material and seaming the strip with one or more rows of stitches. They are frequently used as an edge finish at necklines, hems and sleeve plackets (Fig.4.2e).

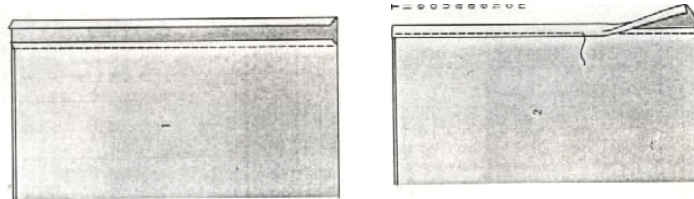
**Fig. 4-2e Bound seam****f. Slot seam:**

This is a variation of lapped seam and is often used down the center front or center back of skirts, coats and dresses. This gives a decorative effect when a different coloured fabric is used for the backing piece stitched in between the two pieces of fabric, which are lapped on to it (Fig.4-2f). Machine baste on the seamline, leaving long threads at each end. Press open the seam. Cut a 1 ½ inch wide underlay of same or contrasting fabric. Centre it under seam and baste.

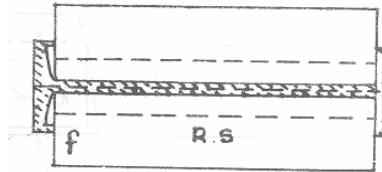
**Fig. 4-2f Slot seam****g. Counter Seam**

This is also a durable flat seam used for very thick materials, men's wear and reversible garments. This can be made by one of the two methods.

Method I

Turn down a little on wrong side (WS) of one piece of fabric and on right side (RS) of the other piece and iron them firmly. Keep wrong side of the first piece of fabric on the right side of the second piece along the edges, maintaining the seam allowances, and tack it in position. Machine stitch along the folded edges (Fig 4-2g). This is called three-layered counter seam

Method II

Turn down 0.5 cm on the wrong side of one piece of fabric and on right side of the other and iron them firmly. Keep wrong side of the first piece on the right side of the second piece and slip the turned down edges under each other. Pin it in position, tack it and machine stitch along the folded edges from the right and wrong sides (Fig 4-2h). This is called four-layered counter seam.

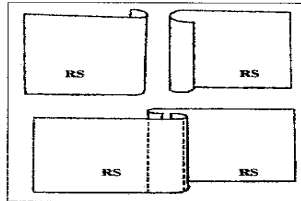

**Fig. 4-2g Counter Seam
(three layered)**

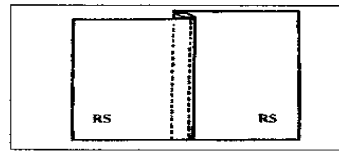

**Fig. 4-2h Counter Seam (four
layered)**

4.3 SEAM FINISHES

Seam finishes are made to prevent fraying of the raw edges and thus make the seams more durable. They also provide a neat appearance to the inside of the garment. Though not essential to completion of the garment, it can add measurably to its life. Three considerations determine the seam finish decision –

- the type and weight of fabric
- the amount and kind of wear and care the garment will receive
- whether or not seams will be seen

There are several types of seam finishes in use.

a. Pinked finish:

This is a quick method done with pinking shears, which is not bulky, but not a suitable finish for fabrics that ravel badly. After stitching plain seam trim off about 1/8 inch of the seam allowance using the pinking shears (Fig.4-3a). Then press the seam open.

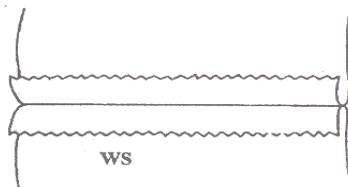
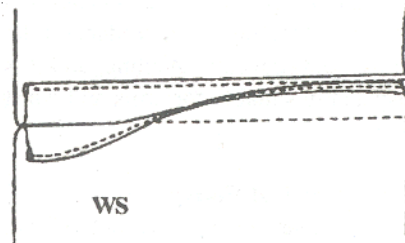

Fig. 4-3a Pinked seam finish

b. Edge stitched finish:

The seam is stitched and pressed open (Fig.4-3b). Then turn under $\frac{1}{4}$ inch on each seam edge and top stitch close to the fold without catching the garment. This is a bulky finish and is not suitable for deeply curved seams. This is mostly used on unlined coats and jackets where the seam allowance is wide.

**Fig. 4-3b Edge stitched finish****c. Double stitch finish:**

After making a plain seam, work an extra line of stitching about $\frac{1}{4}$ inch from the raw edge (Fig.4-3c). This is done for a plain unfinished seam or pinked seam and is not suitable for bulky fabrics.

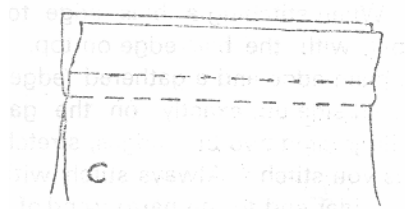
**Fig. 4-3c Double stitch finish****d. Overcast finish:**

This is a common method used for both thick and thin materials that fray easily. It is also suitable for narrow seams and also for seams that receive hard wear or extra strain such as armholes and waistlines. After making the plain seam, press the seam open and work overcasting stitches over the raw edges of the two seam allowances separately (Fig.4-3d)

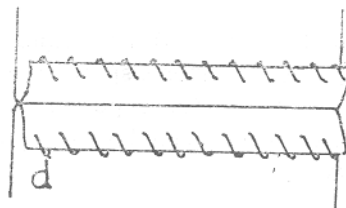
**Fig. 4-3d Overcast seam finish**

e. Herringbone finish:

This finish neatens the raw edges of heavy materials like flannel. It also holds down the turning, making the seam flat avoiding the bulkiness. After pressing the seam open, herringbone stitches are worked on the two raw edges, catching the garment (Fig.43e)

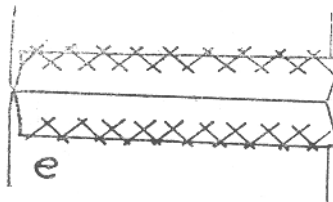

Fig. 4-3e Herring bone finished seam

f. Bound seam edge finish:

In this method the seam is pressed open and the bias binding attached to both the seam edges (Fig.4-3f). For thin fabrics seam allowances could be pressed together and bias binding attached to each layer separately

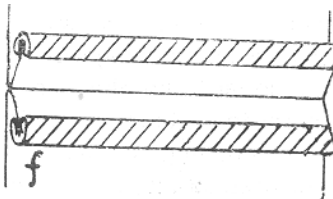

Fig. 4-3f Bound seam edge finish

Summary

A method of joining to layers of fabrics together either by hand or machine is essential in garment construction. Hand sewing stitches may be used depending on the end use – either temporary or permanently. The type of seam used depends upon a number of factors such as texture, durability, purpose of the garment, shape of the seam and current fashion. Seam finishes provide a neat appearance to the inside of the garment and can be chosen depending on the type of the fabric and end use

Short Answer Type Questions

1. What are temporary stitches?
2. What is a seam?
3. Where is lapped seam used?
4. Why are seam finishes necessary in garment construction?
5. What is a counter seam?

Essay Type Questions

1. What are permanent stitches? Write briefly about different types of hemming stitches.
2. Give an account of various seam finishes used.
3. Write about the suitability and application of various seams in garment making process.
4. Give the step wise procedure for finishing a raw edge with bound seam edge finish.

5.0 FULLNESS

Introduction

Fullness of material is an important feature of style as well as a necessity for ease of movement in a well fitted garment, whereas, fashion changes the basic methods of controlling fullness that frequently recur, though adapted to enhance the current style. Darts, tucks, pleats, gathers etc are some of the devices for introducing fullness.

5.1 TUCKS

A tuck is a fold of fabric stitched in place by running stitch or machine stitch on the right side of the garment as a means of - shaping the garment to the body, for holding in fullness or add decorative effect at shoulders, waistlines, yokes, pockets or cuff of sleeves etc. The tucks that are partly stitched help in shaping the garments. These are also used in children's garments to hold the allowance for growth. Tucks add body to thin fabrics and textural interest to plain fabrics.

Tucks can be used in groups or clusters and in graduated width. When calculating the amount of material that is needed, each tuck calls for an allowance equal to twice its finished width. So for making a group of 4 tucks of 1/8 inch finished width, allow
 $4 \times (1/8 \times 2) = 1$ inch extra material.

To stitch each tuck fold along middle so that stitching lines coincide. Then stitch along the markings. Cut the garment section only after completing the stitching of the tucks. There are several methods of tucking:

a. Pin tucks:

These are tiny dainty tucks used on baby clothes and fine blouses. To stitch each tuck fold, along the middle of the markings. Tack or machine baste about 1/8 inch wide from the fold (Fig.5-1a).

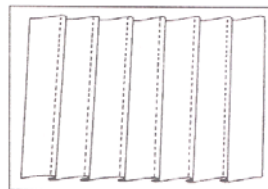

Fig. 5-1a Pin tucks

b. Piped or Corded tucks:

These are made by placing cording on the wrong side of the fabric at center of tuck before stitching the tuck (Fig.5-1b) and stitched close to the cording

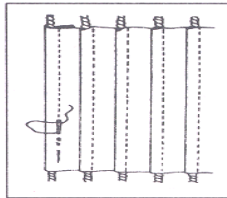

Fig. 5-1b Piped or corded tucks

c. Shell or scalloped tucks:

This is a very decorative tuck made by hand or machine. Stitch the tuck using small running stitches. As you come to each dot, take two overcast stitches through the dot and pull tight, before proceeding further with the running stitches (Fig.5-1c).

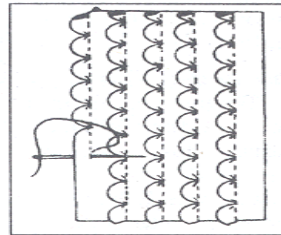

Fig. 5-1c Shell or Scalloped tucks

d. Crossed tucks:

When rows of tucks are stitched along the fabric in both horizontal and vertical directions, the decoration is called cross tucking. First stitch the vertical tucks and press them to one side. Then stitch the horizontal tucks (Fig.5-1d).

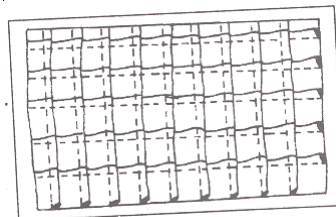

Fig. 5-1d Crossed tucks

5.2 PLEATS

Pleats are folds of fabric that provide fullness in some parts of a garment. They can be placed single or in a series and can be pressed flat or left unpressed, according to the style of the garment. Pressed pleats give a smooth, slimming line to a garment, whereas, unpressed pleats provide a softer and fuller shape.

Pleats are introduced usually at the waist line of skirts and dresses, to provide fullness evenly all around. The preparation of pleats is similar to that of tucks, the main difference being that pleats are seldom stitched all the way down. Sometimes they are stitched part way down the garment for flatness. Each pleat require extra material of twice the width of the finished pleat. If pleats are to touch each other all round the garment, the amount of material needed is three times the finished width. There are different types of pleats that can be used in garment construction. Among more commonly used are.

a. Knife pleats:

They are usually about 1/2 inch to 1 inch wide and are turned towards the same direction (Fig.5-2a). The direction may be reversed at center back or centre front of the garment. Make all the pleats in the same direction. Press them. Pleats can be top stitched in place from waist to hip to produce the slender effect. The main function of a knife pleat in a tailored garment is to provide fullness at the bottom of the garment.

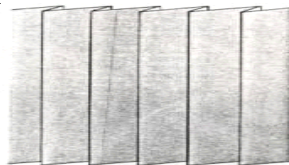

Fig. 5.2 a knife Pleats

b. Box pleats:

Two knife pleats turned away from each other (one to the left and one to the right) form a box pleat (Fig.5-2b). These are used quite often for uniforms.

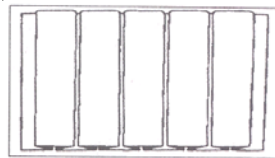

Fig. 5-2b Box pleats

c. Inverted pleat:

It is the opposite of a box. It is made up of two knife pleats turned towards each other so that the folds meet in the middle on the right side of the garment. It is usually designed at centre front or centre back and looks like two knife pleats facing away from each other on the under side (Fig.5-2c)

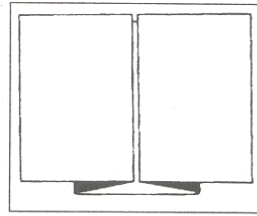

Fig. 5-2c Inverted box pleat

5.3 GATHERS

Gathering is an effective and decorative way of distributing fullness over a given area. Gathers are graceful folds of fabric that provide fullness, suggesting a soft look, which can be made using machine or hand stitches. These are formed by drawing the fabric together on a line of stitching and may be used to control the fullness at round waist, yoke lines, waist lines, neck lines and upper and lower edge of sleeves. Gathering is done by different methods, such as:

a. Gathering by hand:

Work two rows of running stitches $\frac{1}{4}$ inch apart – $\frac{1}{8}$ inch above and below the seam line. Draw the ends of threads until the section measures the desired length and secure the thread by winding round a pin as shown (Fig. 5-3a).

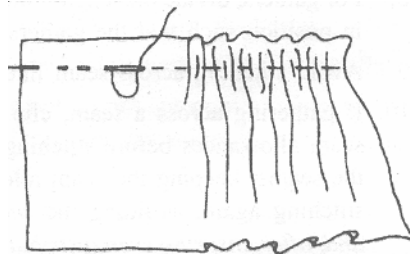

Fig. 5-3a Hand gathering

b. Gathering by machine:

Make seam line on the right side of the fabric by adjusting the machine for long stitch and loosening the upper tension slightly. Now work two rows of machine stitches $\frac{1}{4}$ inch apart. Distribute the fullness evenly by pulling both bobbin threads together (Fig. 5-3b).

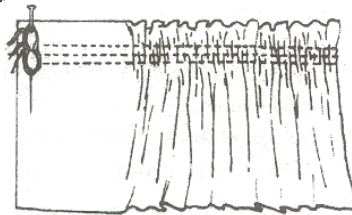

Fig. 5-3b Machine gathering

c. Gathering by using elastic:

Gathers can be made by stretching a narrow strip of elastic and stitching on the part of the garment which is to be gathered (Fig. 5-3c).

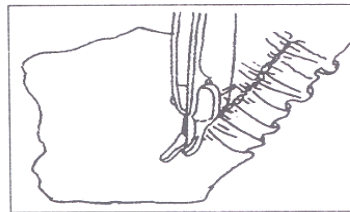

Fig. 5-3c Gathering using elastic

5.4 SHIRRING OR GAUGING

When several rows of gathering (3 or more) are used for a decorative finish these are termed shirring (Fig.5-4). The rows should be evenly spaced. Shirring appears as a decorative feature at the shoulder, waistline, at the lower edge of a sleeve and usually at the narrower parts of garment also allowing a certain degree of stretching. Shirring can be done by these methods –

- Thread shirrs
- Elasticized shirrs



Fig. 5-4 Shirring

5.5 SMOCKING

It is a type of fabric enrichment, consisting of tiny embroidery stitches sewed over the folds of gathers at regularly spaced intervals on the right side of the fabric. It is used to hold fullness or to add texture and surface interest to a bodice, neckline or sleeves of children's or women's dress. Best-suited fabrics for smocking are soft and flat-faced fabrics such as voiles, cambric and crepes. Use a medium-weight and firmly twisted thread of cotton or silk.

Gathering Fabric:

Smocking on plain material requires marking with a series of dots on the wrong side (Fig. 5-5a.a). These dots should be evenly spaced, around 0.3 cm apart, and the distance between the rows may be 0.5 -1 cm. For heavy fabrics the distance can be more. Fabrics with checks, plaids or dots do not require the transfer of the pattern. Using strong thread, pick up the dots along one row and make several running stitches along. Complete all the rows. The number of rows depends on the area to be covered. The width of fabric should be three times as long as the gathered fabric for smocking area smocking is to cover. Draw up the fabric on the threads and fasten the thread ends by winding them together round the pins placed at one end to hold them securely (Fig. 5.5 a.b)

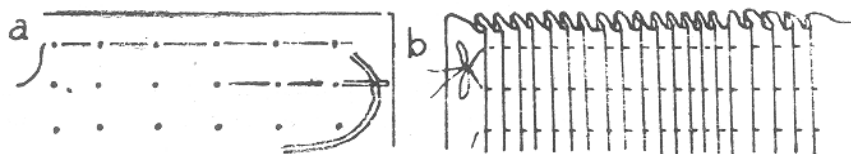

Fig. 5.5a Preparation of material for smocking

Stitches Used for Smocking:

All the stitches are worked from left to right. Good quality embroidery threads of suitable colour are used for smocking.

a. Outline stitch

This is like a stem stitch used to make outlines. Work each row over the tubular fabric folds. Take out needle on the first fold on the extreme left by making small back stitch over the fold. While making the stitch, always keep the thread under the needle. Draw up each fold firmly, after each stitch (Fig.5.5b).

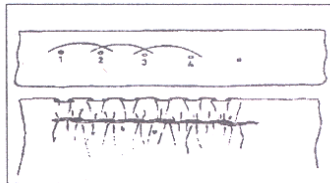

Fig. 5.5b Outline stitch

b. Cable stitch

It is a variation of outline stitch done in two close rows. Start in the same way as for the outline stitch. While taking stitch, keep the thread above the needle for the first stitch and below the needle for the second, and repeat throughout the length of the row (Fig.5.5c).

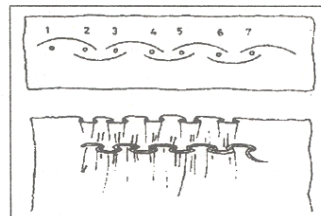

Fig. 5.5c Cable stitch

c. Wave stitch

To make wavy effect, make odd number (5, 7, 9) of outline stitches diagonally upward and then downward. For the upward row keep the thread below the needle and for the downward row keep the thread above the needle. Repeat the process to make rows of diamond shapes or rows of wavy design (Fig.5.5d).

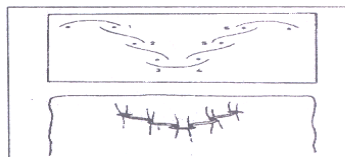

Fig. 5.5d Wave stitch

d. Honeycomb smocking:

To start with, bring the needle out in first pleat; take two tiny backstitches over fold to secure the thread. Pull the needle through the first fold about 0.5 cm below the first stitch, keeping the thread above the needle. With thread below the needle, put the needle through the second fold at the same level. Draw the thread tightly together. Put the needle through the same fold at the same level as the first stitch. With thread above the needle, put the needle through the third fold at the same level. Draw tightly together. Repeat till the end of the row (Fig.5.5e).

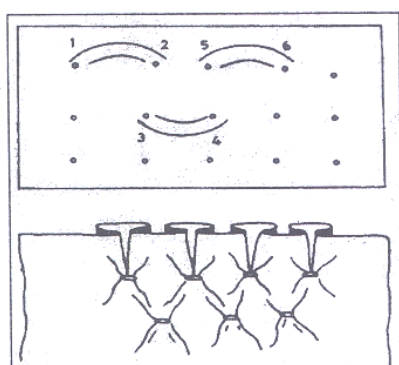

Fig. 5.5e Honey comb stitch

5.6 FRILLS OR RUFFLES

A ruffle is a strip of fabric cut or handled in such a way as to produce fullness. These are used for the purpose of adding decoration to a garment. Sometimes they are used at the hems of skirts and dresses to add length. To make frills allow at least one and a half times the length of the piece to which the frill will be attached. The width of the frill is usually anything from one inch to 3 inches. The longer side should be cut along the lengthwise grain of the material. The gathered edge of the frill can be concealed in a seam, facing, binding or wide band (Fig.5.6).



Fig. 5.6 Frills or Ruffles

5.7 GODETS

These are wedge shaped pieces which are usually set into a skirt so that the wide side of the wedge becomes a part of the hem of the skirt. The godet may be set into a seam of the skirt, or the skirt may be slashed so that the slashed edges form the seams that join into the godet (Fig.5.7). Panels are cut and godets are stitched between panels.

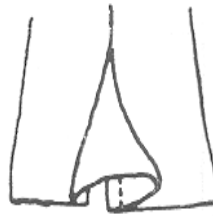

Fig. 5.7 Godet

Summary

Fullness is introduced into garments for various reasons such as - to give good shape and proper fit to the garment; to allow freedom of movement and comfort to the wearer and to make the garment look attractive. Darts, tucks, pleats, gathers etc are some of the devices for introducing fullness.

Short Answer Questions

1. What is tuck?
2. What is godet?
3. Where are shell or scalloped tucks used?
4. What are the different methods of gathering fabric?

Essay Type Questions

1. What is the difference between gathering and shirring?
2. Write briefly about the different types of tucks.
3. Differentiate between box pleat and inverted box pleat.
4. Give the procedure for making godet.
5. What is the procedure for making a ruffle?

6. 0 PLACKETS

Introduction

Plackets are finished openings constructed in order to make it easy to put on or take off a garment. When the garment is in use, plackets are kept closed with the aid of fasteners such as zips, buttons and buttonholes, press buttons, hooks and eyes etc. They are used at waist lines, necklines, wrists and other snug fitting parts of garments. A placket may be made in an opening left in a seam, or in a slash cut in a garment. The former is stronger and gives a better finish when completed. Plackets can be differentiated into two types of plackets – **Inconspicuous** and **Conspicuous**.

6.1 INCONSPICUOUS PLACKETS

The continuous bound plackets, bound and faced plackets and zipper plackets are examples of inconspicuous plackets.

a. Continuous bound placket:

This is also called one-piece placket and may be made in a seam or slash (Fig. 6.1a). It is suitable for children's dresses, undergarments like saree petticoat, and for sleeve openings where a cuff or band is used. Do not use this placket on curved seams and on bulky fabrics

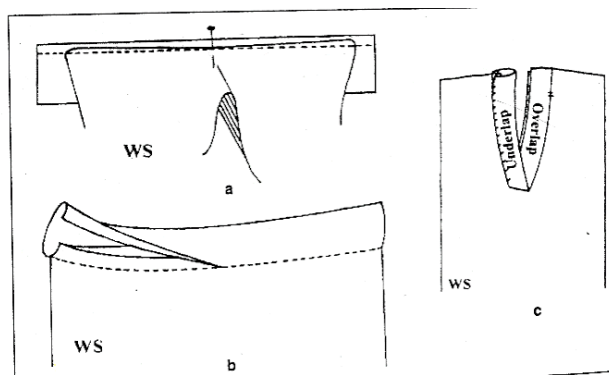

Fig. 6.1a Continuous bound placket

To make a placket in a slash, cut a strip of fabric on the lengthwise grain, $1\frac{1}{4}$ inch to $1\frac{1}{2}$ inch wide and one inch longer than twice the length of the opening. Tack the piece to garment opening and machine stitch keeping the opening flat and pushing the fold of material so as to avoid a pleat in the centre of the fold. Then fold the strip over the seam edge and hem it along the stitching line. Fold the strip under on the overlap section and tack it at the seam. Tacking can be removed after the fasteners are fixed.

b. Bound-and-faced placket or two-piece placket:

This is used in the left seam of skirts or petticoats and back seam of dresses. The underlap side of this placket is finished with a binding and the overlap with a facing. For this, two separate strips of fabric are used, one of width $1\frac{1}{2}$ inches for the overlap and a wider one ($2\frac{1}{4}$ inches) for the underlap. Both the strips should be one inch longer than the placket opening. The one inch extra length of the strips should extend below the placket opening. To finish underlap, crease the strip back over the seam, bring its free edge to the wrong side of garment, turn under $\frac{1}{4}$ inch at the free edge and hem the fold to the stitching line. This forms the bound side of the placket and should be $\frac{1}{2}$ inch to $\frac{3}{4}$ inch wide.

Make a $\frac{1}{4}$ inch or wider fold to the wrong side of overlap's free edge, turn the strip over to the wrong side of the garment (as for a facing) and hem or slip stitch the fold to the garment. Work a line of stitches at the base of the placket catching the underlap and overlap together (Fig.6.1b). This can be done by hand from the wrong side in such a way that no stitches are visible on the wrong side.

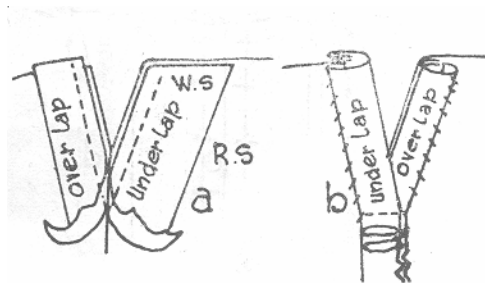

Fig. 6.1b Bound and faced placket

c. Zipper Plackets:

There are several methods of applying zippers. The choice depends on the position of the zipper in the garment and the type of garment. Zippers are usually concealed either with two overlapping fabric edges or with one (fig. 6.1c). The former shows two lines of stitching and is referred to as slot seam zipper placket. The latter is called lapped seam zipper placket and only one line of stitching is visible on this. Generally the lapped seam application is used on side openings in garments and slot seam placket on center back and center front openings.

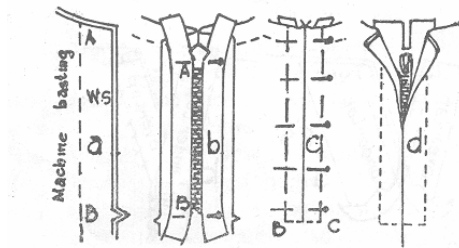

Fig. 6.1c Zipper placket

Close the placket opening temporarily by machine basting from A to B as in fig. 6.1c-a. With the zip closed, place it face down over the pressed open on the wrong side of the garment as in fig. 6.1c-b. The center of the zipper should fall exactly on the machine basted seam line. Match bottom of the metal part of the zipper to bottom of machine basting at B. The top of the zipper should be $\frac{1}{4}$ inch below the finished placket line. Keeping the zip pulled taut, hand baste firmly along each side of the zipper. At the bottom baste across the zipper tape from B to C about $\frac{1}{4}$ inch below the metal part of the zipper. Do the final top stitching from the right side of the garment by machine.

6.2 CONSPICUOUS OPENINGS AND PLACKETS

Tailored plackets are conspicuous plackets commonly seen on men's shirt sleeve, on men's shirt sleeve openings and on neck openings on kurtas, children's dresses.

Kurta plackets:

This is a simple neck finish used on infants and children's clothes. To make this, slash the opening down from the neck at center front or center back and apply bias binding to the openings (Fig. 6.2a).

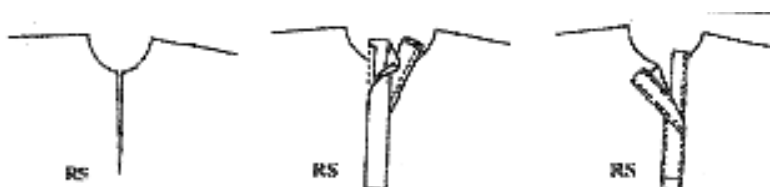

Fig. 6.2a Kurta Placket

The underlap and overlap sides of the garment should extend beyond the centrefront line by $1\frac{1}{2}$ times the finished width of the pleat plus $\frac{3}{4}$ inch. To finish the underlap, mark a fold $\frac{3}{4}$ inch beyond the center front line, make the fold to the wrong side and tack in position (Fig. 6.2a-b). When the garment is finished, the fasteners will hold this fold in position.

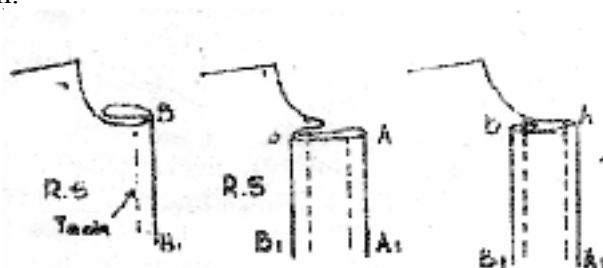

Fig. 6.2b Centre front -box pleat in placket

The overlap edge can be finished by marking the first fold line AA_1 $1\frac{1}{2}$ inches (width of the pleat) away from CC_1 (fig. 6.2b-d) and BB_1 is 3 inches (twice width of the pleat). Turn under the first fold to wrong side so that the raw edge or the selvedge touches the second fold line. Make a second fold to the wrong side on the second fold line BB_1 and tack exactly $\frac{3}{8}$ inch away from this fold as in fig. 6.2b-c. Bring back the first fold AA_1 to the right side and crease along the tacking line to form the box pleat. To hold the pleat in position, machine $\frac{1}{4}$ inch away from the edge BB_1 . Work a row of stitches $\frac{1}{4}$ inch away from the free edge AA_1 . Remove the tacking.

Summary

Plackets are finished openings constructed in order to make it easy to put on or take off a garment. Plackets are kept closed with the aid of fasteners such as zips, buttons and buttonholes, press buttons, hooks and eyes etc. Plackets can be differentiated into two types of plackets – **Inconspicuous** and **Conspicuous**. The continuous bound plackets, bound and faced plackets and zipper plackets are examples of inconspicuous plackets.

Tailored plackets are conspicuous plackets commonly seen on men's shirt sleeve, on men's shirt sleeve openings and on neck openings on kurtas, children's dresses.

Short Answer Type Questions

1. What is a placket?
2. What are the two different types of placket openings?
3. Write about the use of conspicuous placket openings.
4. What are the aids used for closing a placket?

Essay Type Questions

1. Write the procedure for finishing a placket opening with zipper.
2. Differentiate between continuous bound placket and bound and faced placket.
3. Explain the procedure for constructing a kurta placket.

7.0 NECKLINES

Introduction

Neckline is an outline of bodice around the neck. It can be shaped in different ways and styles to get a decorative effect, particularly for ladies garments. Round, square, V-neckline, U-neckline etc. are the most commonly used basic shapes of plain neckline (Fig.7).

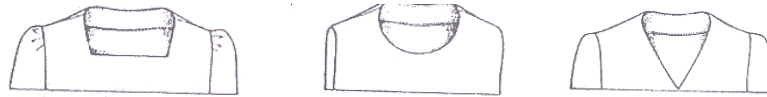

Fig. 7 Different shapes of necklines

7.1 DIFFERENT METHODS OF FINISHING NECKLINES

A neckline may be finished with a facing, binding or a collar. The type of finish chosen will depend on the design of a garment, the fabric and in some cases even personal preference. Necklines are generally curved and hence tend to stretch during handling. It is therefore important to note that before garment construction, a row of stay stitching is done at a distance of 0.5 cm from the edge of the neckline, so that it will not stretch.

A straight piece of material attached to a curve will look bulky and untidy. The elasticity of bias permits it to stretch or contract and thus take the shape of any curved edge giving it a flat smooth finish. Bias strips can be applied as facings and bindings.

Bias and its Uses

True bias falls on a diagonal line at 45° to the lengthwise and crosswise grains. It has the maximum elasticity or in other words it stretches more than any other direction on cloth (Fig. 7.1a).

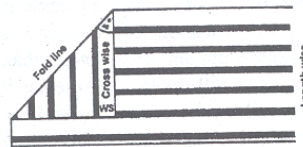

Fig. 7.1a Preparation of bias strip

Cutting bias strips

Fold the fabric diagonally so that the lengthwise threads of the folded part fall parallel to the crosswise threads on the rest of the material. Using a gauge or ruler, measure from the fold to desired width of bias strip and draw parallel lines. Cut strips along the marked lines and trim off ends along warp threads (Fig. 7.1b-a).

Joining bias strips:

Place the two strips to be joined right sides facing and the edges of the outright angles to each other. Shift the top strip $\frac{1}{4}$ inch beyond the other so that the sharp points at the ends of the strips project on either side. Stitch a $\frac{1}{4}$ inch seam joining the points where the sides of the two strips intersect. Press the seam open and trim the seam projections showing on right side (Fig. 7.1b - b & c).

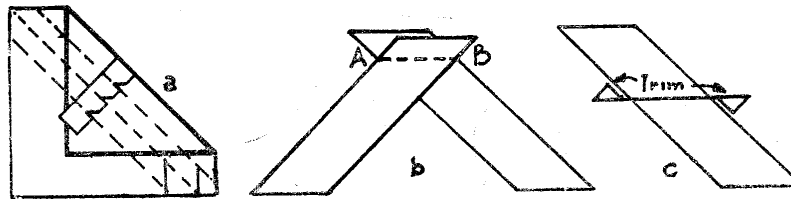

Fig. 7.1 b Cutting and joining of bias strips

7.2 FACINGS:

These are used to provide a neat finish to the raw edges in a garment and to support the shape of necklines, armholes, collars, etc. When the edge to be faced is a straight line, the facing may be cut in one piece with the garment section. Usually facings are applied separately. There are two main types of applied facings - **bias facing** and **shaped facing**.

Shaped facing can be of any width, but bias facing should not be more than $\frac{1}{2}$ inch wide. Facings are usually turned to the inside of the garment and will not show when the garment is worn. Sometimes facings are turned to the outside of the garment for decorative effect.

a. Method of applying bias facing:

Stay stitch edge of garment to be faced. Tack bias strip to edge of garment, right sides facing beginning at a seam. For inward corners to be faced, the bias must be eased and for outward curves it must be stretched. (Easing means holding bias strip slightly loose at the seam line). Stitch bias to the edge of the garment in line with the bias on top. Trim the seam to $\frac{1}{4}$ inch, clip at curves, grade bulky seams and ends coinciding. Turn the strip to wrong side, under stitch the facing to the seam. Making sure that the facing is not visible from the right side of the garment. Now hem or slip stitch the facing to the garment. When finished, the bias facing should be about $\frac{3}{8}$ inch wide (Fig.7.2a).



Fig. 7.2a Applying bias facing

b. Applying shaped / fitted facing:

Shaped facing is cut to the exact shape of the garment edge to which it is to be applied. Usually it is cut on the same grain as the section of the garment. Shaped facing is often used to finish square or V-necklines or scalloped edges. It is easier to apply fitted facing than bias facing and is less conspicuous. It is usually cut separately for front and back. After cutting, join the front and back facings with a plain seam, trim the seam and press it open. Finish the outer edge of the facing by turning up the edge and stitching it. Carefully tack the facing to the garment section, right sides facing, and seam lines, center lines and notches matching. Trim, clip and grade seam edges turn the facing to the wrong side under stitch it at the seam and hem or slip stitch the folded edge of the facing to the garment (Fig. 7.2b).

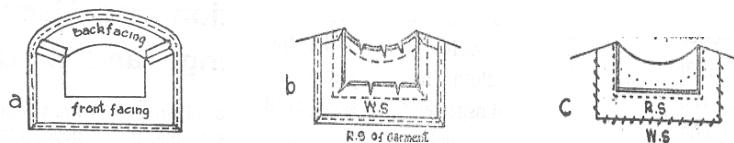

Fig. 7.2b Applying shaped or fitted facing

7.3 BINDING:

Bias binding:

Bias binding is used to finish and strengthen raw edges and to add a decorative trim to a garment. It shows both on the right and wrong sides. It is used to finish necklines, armholes, sleeve edges, front closings, collars, cuffs and seams. It can be adapted equally well to straight, curved, gathered and irregular edges. When finished, bias binding should have uniform width (less than $\frac{1}{4}$ inch) and should lie flat and smooth without any stitches showing on the right side of the garment.

There are two kinds of bias bindings: **Single binding** and **double binding** (or French binding).

a.. Single bias binding:

Cut a bias strip that is twice the finished width plus two seam allowances. Tack the strip to the garment right sides facing. Stitch the binding to the garment with a plain seam. Trim the seam as wide as the finished binding. Turn under $\frac{1}{8}$ to $1\frac{1}{4}$ inch on the outer edge of the bias and fold it over the seam on the wrong side. Now hem the fold to the line of stitching using hemming stitches (Fig. 7.3a).

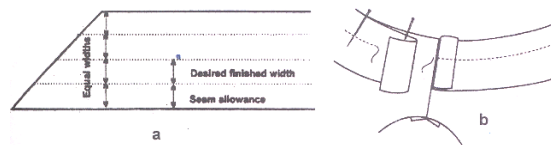

Fig. 7.3a Single bias binding

b. Double bias binding:

Double bias binding or french bias is used on sheer fabrics. Cut bias strip that is six times the desired finished width. Fold the strip in half, wrong sides together, and press. Stitch raw edges of binding to the garment on the right side and hem the folded edge to stitching line on the wrong side (Fig. 7.3b)

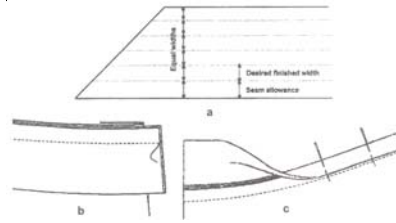

Fig. 7.3b Double bias binding

Summary

Neckline is an outline of bodice around the neck. It can be shaped in different ways and styles to get a decorative effect, particularly for ladies garments. A neckline may be finished with a facing, binding or a collar. A straight piece of material attached to a curve will look bulky and untidy. The elasticity of bias permits it to stretch or contract and thus take the shape of any curved edge giving it a flat smooth finish. Bias strips can be applied as facings and bindings. There are two main types of applied facings - bias facing and shaped facing. Bias binding is used to finish and strengthen raw edges and to add a decorative trim to a garment. There are two kinds of bias bindings: Single binding and double binding (or French binding).

Short Answer Type Questions

1. What are the different ways of finishing a neckline?
2. What is true bias?
3. Where is double bias used?
4. What is the purpose of facings and binding in garment construction?
5. Why do you need to finish a neckline?

Essay Type Questions

1. Give the importance of true bias and the method of cutting and joining the bias strips.
2. Differentiate between bias facing and fitted facing.
3. Write the procedure for finishing a neckline with double bias binding.

8.0 FASTENERS

Introduction

All garments need openings at some point or the other so that they can be put on and taken off easily. These openings can be closed in a variety of ways. The type of closures selected will depend on the position, the amount of strain it will receive and whether it is to remain concealed or form a decorative feature on the garment. It is important to remember with all types of closures that the two sides of the opening match perfectly without any puckering, pulling or gaping of the fabric and give a neat appearance to the garment.

In general, fasteners should be fixed on to double material for strength. They should be fixed in such a way that the right side of the garment laps over the left side for women and the left laps over the right for men. Fasteners should be selected to suit the colour, design and texture of the fabric, the style and use of the garment and the position of the placket. One should also consider the age and sex of the wearer. For example buttons and buttonholes are generally used for men's shirts, trousers etc., just as press buttons and hooks and eye are commonly used for ladies' cholis and children's dresses.

8.1 HOOKS AND EYES

Hooks and eyes are small but comparatively strong fasteners. Though they are mostly applied at single point of a garment opening, such as waistband or neckline, they can also be used to fasten an entire opening. There are several types of hooks and eyes, each designed to serve a particular purpose. General-purpose hooks and eyes are the smallest of all the types and are used primarily as supplementary fasteners, for example a hook and an eye at the top of zipper placket.

Special-purpose hooks and eyes are larger and heavier, which can withstand more strain than those of the general purpose type. The hook is always sewn on to the back of the overlap and positioned so that the end of the hook does not extend further than the edge of underlap of the garment. Oversew, each, loop and across the bar of the hook. Position the metal bar or eye on the opposite right side of the underlap and over

sew around the loops. The hook and eye should appear invisible when fastened.

In some cases, a thread eye can be used as a hook and eye substitute for a metal eye. A thread eye is not as strong as a metal eye; hence should not be used at places where there is much strain (Fig. 8.1).

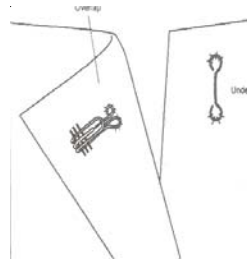

Fig. 8.1 Hooks and eyes (metal)

8.2 THREAD EYES / LOOPS

To form a thread eye, use a single strand of heavy-duty thread or buttonhole twist or double strand of common sewing thread of colour matching with the fabric. A thread eye should be as long as the space between its two placements marks. Insert needle into fabric at one mark and bring it up at the other mark. Apply 2 -3 more stitches in the same way. Cover all the strands with closely spaced blanket stitches, taking care not to catch the fabric beneath. When finished, bring the needle and thread to the wrong side and fasten securely. The thread loop is an inconspicuous fastening which is most often found at the neck edge of collars. To make a thread loop, sew four or five strands of matching thread on the underlap in the correct position, then work button hole stitches over these strands (Fig.8.2)



Fig. 8.2 Thread loops

8.3 BUTTONS

Buttons should be selected carefully to suit both the weight and colour of the fabric. The advantages of using buttons as closures are numerous. They are both functional and decorative. They should be sewn securely by a strong matching thread in such a way that it allows the buttonholes to close under the button without puckering the fabric. The fabric on which the button is attached should be reinforced to prevent tearing or pulling under strain.

There are two types of buttons: Buttons with **holes** and **shank type** buttons. The latter are attached to the garment from the under side. Buttons may be made of fabric, bone, glass, metal, plastic etc. On dresses buttons covered with self-fabric may be used. If you provide scraps of fabric to well established tailors, they get the buttons covered by a special machine. Covering may be done by hand also.

Buttons are placed centrally on the centre front and centre back lines of the garment except in unusual cases. Sufficient buttons should be spaced equally to ensure that the opening is neat without gaping between buttons. The width of spacing varies according to the position of opening, fabric weight and size of button. Very few or many buttons can spoil the appearance of the finished garment. On a shirt or blouse the buttons must be placed to avoid gaping across the bust and on a waisted garment a button must always be used at the waist, because this is the stress point of the garment.

For decoration, buttons can be: (a) grouped in pairs; (b) placed to give a double-breasted effect, and (c) be purely decorative and not as a fastening. Various types of commonly used buttons are flat sew through buttons with two or four holes, buttons with a shank (a small loop on the lower side, used to sew button to the garment), link buttons and covered buttons.

a. Sewing buttons with holes

Sew this type of button using double thread bringing the needle up and down through the holes in the buttons with a pin kept over the button. After working enough stitches, remove the pin, lift the button

and form a shank by winding the thread tightly around the strands about six times. Now fasten the thread on the wrong side. Buttons with four holes may be sewn in the shape of a cross, two parallel lines, a square or an arrow head (Fig. 8.3a).

b. Sewing fancy or shank buttons:

Bring needle through fabric and shank and then back through fabric. Stitch through fabric and shank until button is secure. Fasten thread on underside (Fig. 8.3b).

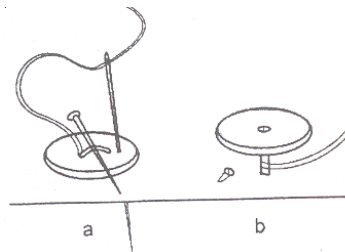

Fig. 8.3 Sewing buttons with (a) holes and (b) shank

C. Sewing Press Buttons or Snaps

Press buttons or Snaps are a kind of small fasteners having less holding power than hooks and eyes (Fig 8.3c). It is best to use them where there is not much strain on the opening. Each press button has two parts - a ball and a socket. General purpose press buttons range in size from fine to heavy.

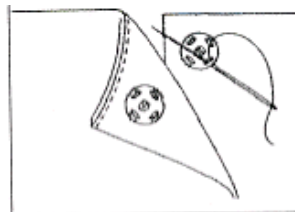

Fig. 8.3c Sewing press buttons

8.4 BUTTON HOLES

Buttonholes are made on the overlap section of the garment opening in line with the buttons on the underlap. They are so placed that when closed the button rests on the centre front or centre back line and centrally on all other openings. Buttonholes can either be **hand worked**, **machine worked** or **bound buttonholes**. The method you choose for a garment will depend on the design of that garment, the fabric and your ability to sew. The steps in working a button hole are as follows-

a. Marking the position for vertical buttonholes:

Vertical buttonholes are often used with a narrow placket, such as a shirt band, or where there are many small buttons involved in closing the garment. They are placed directly on the button placement line and the top of the buttonhole is 3 mm above the mark for centre of button.

b. Marking the position for horizontal buttonholes:

Horizontal buttonholes are the most secure and therefore used on most garments. When buttoned, the pull of the closure is absorbed by the end of the buttonhole with very little distortion. These buttonholes are placed to extend 3 mm beyond the button placement line (Fig. 8.4a).

c. Hand-worked buttonholes:

These are used in children's and men's garments and are worked after the garment is completed. Avoid these on fabrics that stretch and fray. Hand worked buttonholes are used where details of construction are to be finely finished. They should be made with matching thread and should have stitches of uniform length worked close together. Worked buttonholes are made through double fabric, therefore facings, collars and cuffs must be completed first. Mark the centre of the buttonhole with a row of tacking. Mark the length of the buttonhole by placing a button and marking its diameter with a pointed pencil. Do not slash. Stitch around the entire buttonhole, using very fine hand-running stitches to indicate the width of stitching. Fold the buttonhole end to end and make a small cut in the middle with a sharp pointed pair of scissors.

Open cut and slash to each end. Leaving thread unknotted, take a back stitch on the wrong side near the end of the buttonhole. Bring the needle out through the buttonhole to the right side. With the right side of

the garment up, hold the cut buttonhole over the index finger of your left hand and work the buttonhole using buttonhole stitches.

For the **vertical buttonholes**, both the ends are finished in the same shape, either fanned or bar tacked. But for the horizontal buttonholes, the outer end is fanned to accommodate the button shank and the inner end is bar-tacked to give strength (Fig. 8.4 c-f).

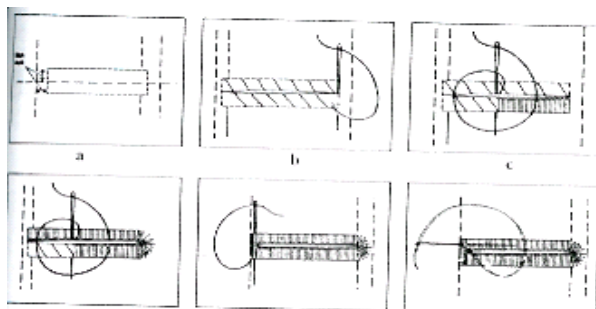

Fig. 8.4 Steps in making button holes (vertical and

d. Bound Button holes

These are more decorative than worked buttonholes and are suitable for women's and children's dresses. A binding strip is used to bind the raw edges of the hole. The binding may also be in contrast colour or design for decorative effects. The steps in construction involve: Pin an interfacing on the wrong side and mark the button hole. Cut a strip of material 1 ½ inch wide and one inch longer than the length of finished button hole. Place the strip with right sides facing and work a row of tacking stitches and then machine baste. Then cut along the tacking line to within ¼ inch of the ends and then cut diagonally to all four corners as in fig. 8.4 a – b. Pull the binding strip through the slit to wrong side of the garment. Next fold back the strip to form an even binding of about 1/8 inch wide along each side meeting the center of opening. Baste the binding along each side of the button hole. Remove the excess interfacing fabric leaving about ¼ inch beyond the button hole at each end.



Fig. 8.4 a & b Steps in working a bound button hole

Summary

All garments need openings at some point or the other so that they can be put on and taken off easily. These openings can be closed in a variety of ways. The type of closures selected will depend on the position, the amount of strain it will receive and whether it is to remain concealed or form a decorative feature on the garment. In general, fasteners should be fixed on to double material for strength. They should be fixed in such a way that the right side of the garment laps over the left side for women and the left laps over the right for men. Fasteners should be selected to suit the colour, design and texture of the fabric, the style and use of the garment and the position of the placket. One should also consider the age and sex of the wearer. Hooks and eyes, buttons, button holes, etc are the different types of fasteners that may be used for fastening an opening.

Short Answer Type Questions

1. What are fasteners?
2. Why are fasteners necessary in garment construction?
3. What are the different ways of working a button hole?
4. What are the different types of eyes that may be used in fastening?
5. What are the possible ways of placing decorative buttons?

Essay Type Questions

1. Explain the steps in working of a vertical button hole.
2. What are the different methods of sewing different types of buttons?
3. Write briefly the procedure for working a bound button hole.

9.0 BODY MEASUREMENTS

Introduction

Accurate body measurements are of vital importance for obtaining best results in cloth construction. Besides good fitting, correct measurements can also contribute towards saving time in constructing a garment. Personal measurements are required not only for stitching the garment at home or getting it stitched, but also for buying readymade garments.

Taking body measurements is a responsible task, which should be undertaken with great care. For this purpose, it is important for a dress maker to have adequate knowledge about correct methods of taking and recording body measurements, equipment required for it and other important points to be considered in taking the measurements.

8.1 POINTS CONSIDERED WHILE TAKING MEASUREMENTS

1. A good quality measuring tape should be used for taking the body measurements. The long metal end of the tape is used for taking vertical measurements and the rounded metal end is used for taking horizontal measurements.
2. Person giving the measurements should stand straight, but in a natural pose and preferably in front of a mirror. A well fitted foundation garments should be worn while giving measurements.
3. Another person is needed to take measurements. Basic lines of the body are to be taken into consideration while measuring body parts.
4. Before body measurements are taken, a cord or tape is fastened around the waist and left until all measurements have been completed. The tape should be kept parallel to the ground while taking girth measurements like bust, waist, hip, etc.
5. The accuracy of several measurements depends on this exact waistline location. Add to these measurements the suggested amount of ease.
6. The amount of ease needed varies with the type of fabric used. More ease is needed for woven fabrics than knits.

7. A proper order and certain sequence should be followed in taking the measurements to make it more systematic.

9.2 EQUIPMENTS REQUIRED FOR MEASURING

Measuring tape, and L-shaped ruler are the most commonly used equipment for taking body measurements. However, for taking body measurements, protractor with spirit level, vernier caliper, ribbons, and marking pencil may also be required

9.3 WHERE AND HOW TO TAKE MEASUREMENTS

Measurements can be taken **directly** on a person for whom the pattern is to be developed

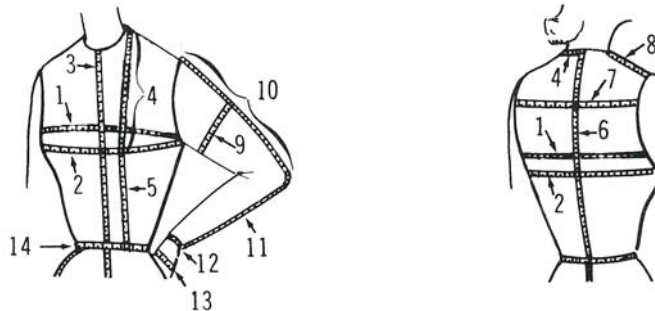

Fig. 9.1 Locations for taking upper body measurements

A. Upper Bodice Measurements:

- 1. High bust:** measure around back and chest just above bust, keeping tape parallel to the floor across back.
- 2. Bust:** measure over the fullest part of bust.
- 3. Center front bodice length** – measure center front from base of neck to waistline tape.

4. Length from center back neck to tip of bust – measure from tip of bust around neck to tip of other bust and divide the measurement into half.

5. Length from center back neck over bust to waistline – measure from waistline over tip of bust around neck over other bust to waistline.

6. Center back bodice length – measure center back from base of neck to waist line tape.

7. Back shoulder width – 4 inches below base of neck at center back, measure distance from armhole to armhole, keeping tape parallel to floor and arms relaxed at sides.

8. Shoulder length – neck to arm socket – measure shoulder length from base of neck to arm socket.

B. Sleeve Measurements:

9. Upper arm circumference – with arm bent and fist clenched, measure around fullest part of the upper arm.

10. Arm length - shoulder to wrist – with arm bent, measure from arm socket over elbow to wrist bone.

11. Wrist circumference – measure around wrist below wrist bone

12. Hand circumference – touch thumb to little finger, then measure at the position of greatest circumference.

C. Lower body measurements:

13. Waistline – measure waist circumference. Allow enough ease for comfort in wearing finished garment.

14. High hip – measure high hip circumference 3 inches below waistline tape. Keep parallel to floor

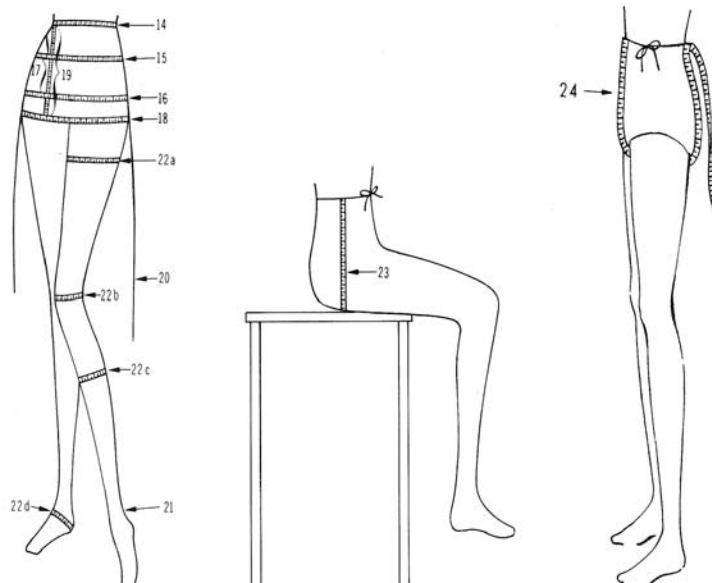

Fig. 9.2 Locations for taking lower body measurements

15. Hip at fullest part - measure fullest part of hip keeping tape about 7 inches down from waist and mark this point midway between side and center front. tape parallel to floor.

17. Waist to fullest part of hip – measure from waistline tape to hip as determined in step 16.

18. Thigh – slip tapeline down to largest measure of thighs, keeping tape parallel to floor.

19. Waist to thigh – measure a distance from waist to thigh as in step 18.

20. Skirt length – measure from waist to floor at center front, center back, right side and left side. Subtract the number of inches skirt is to be worn from floor. Add hem allowance as needed.

21. Pants length – measure from waistline along side seam to desired length for pants.

22. Leg circumference – measure the fullest part of thigh, bent knee, calf, and instep.

9.4 MEASUREMENT CHART FOR BODICE AND SKIRT

Table 2 (in Inches)

Location	32"	34"	36"	38"	40"	42"	44"
Front Length	17 ¼	17 ½	17 ¾	18	18 ¼	18 ½	18 ¾
Width of Bust	9 ½	10	10 ½	11	11 ½	12	12 ½
Centre Front	14 ⅜	14 ½	14 ⅝	14 ¾	14 ⅞	15	15 ⅛
Apex	3 ⅝	3 ¾	3 ⅞	4	4 ⅛	4 ¼	4 ⅜
Under Arm Seam	7 ⅞	8	8 ⅛	8 ¼	8 ⅜	8 ½	8 ⅝
Front Waist line	6 ⅜	6 ¾	7 ⅛	7 ½	7 ⅞	8 ¼	8 ⅝
Waistline to Shoulder	14 ¾	14 ⅞	15	15 ⅛	15 ¼	15 ⅜	15 ½
Shoulder length	4 ⅞	5	5 ⅛	5 ¼	5 ⅜	5 ½	5 ⅝
Centre Front to Princess Line	2 ⅝	2 ¾	2 ⅞	3	3 ⅛	3 ¼	3 ⅜
Width of Back	8 ½	9	9 ½	10	10 ½	11	11 ½
Centre Back Length	16 ½	16 ¾	17	17 ¼	17 ½	17 ¾	18
Back waistline	5 ⅝	6	6 ⅜	6 ¾	7 ⅛	7 ½	7 ⅞
Shoulder blade	6 ⅞	7	7 ⅛	7 ¼	7 ⅜	7 ½	7 ⅞
Center back to princess line	2 ½	2 ⅝	2 ¾	2 ⅞	3	3 ⅛	3 ¼
Front hip line	9 ⅛	9 ⅜	9 ⅝	9 ⅞	10 ⅛	10 ⅜	10 ⅝
Back hip line	9 ⅛	9 ⅜	9 ⅝	9 ⅞	10 ⅛	10 ⅜	10 ⅝

Summary

Accurate body measurements are of vital importance for obtaining best results in cloth construction. Besides good fitting, correct measurements can also contribute towards saving time in constructing a garment. Taking body measurements is a responsible task, which should be undertaken with great care. Measurements can be taken directly on a person for whom the pattern is to be developed or on a standard dress form of intended sizes

Short Answer Type Questions

1. What are the different methods of taking measurements?
2. What are the tools used for taking measurements?
3. Why are accurate body measurements necessary in garment construction?

Essay Type Questions

1. What are the points to be considered while taking body measurements?
2. How do you take upper bodice measurements?
3. Discuss about the various lower bodice measurements that are needed in garment construction process.

Bibliography

- 1.Amanda O' Neill (1991) Needle Work and Sewing Techniques – The Complete Encyclopaedia Quintet Publishing Limited, London.
- 2.Eleanor J. Gawne & Bess V. Oerke (1975) Dress 4th edition Chas A. Bennett Co., Inc. Peoria, Illinois.
- 3.Hilary Campbell Designing Patterns Stanley Thornes Publishers Ltd., USA.
- 4.Janeaton (1986) Complete Stitch Encyclopaedia Hamlyn Publishing, London.
- 5.Labanya Mazumdar & Vatsala. R (2004) Text Book of fundamentals of Clothing Construction, ICAR New Delhi.
- 6.Mary Mathews (1985) Practical Clothing construction – Part I & II Papripack, Chennai.
- 7.Raul Jewel Encyclopaedia of Dress Making (2000) APH Publishing Corporation, New Delhi.
- 8.Unit Method of Clothing Construction (1977) Women's and Men's Wear 6th Iowa Home Economics Association.