

# Grade 12 Chemistry

A Foundation for  
Implementation



# ***GRADE 12 CHEMISTRY***

*A Foundation for Implementation*

**2013**

Manitoba Education

Manitoba Education Cataloguing in Publication Data

Grade 12 chemistry [electronic resource] : a foundation for implementation

ISBN: 978-0-7711-5285-6

1. Chemistry—Study and teaching (Secondary).
  2. Chemistry—Study and teaching (Secondary)—Manitoba.
  3. Chemistry—Curricula.
- 530.0712

Copyright © 2013, the Government of Manitoba, represented by the Minister of Education.

Manitoba Education  
School Programs Division  
Winnipeg, Manitoba, Canada

Every effort has been made to acknowledge original sources and to comply with copyright law. If cases are identified where this has not been done, please notify Manitoba Education. Errors or omissions will be corrected in a future edition. Sincere thanks to the authors, artists, and publishers who allowed their original material to be used.

All images found in this document are copyright protected and should not be extracted, accessed, or reproduced for any purpose other than for their intended educational use in this document.

Any websites referenced in this document are subject to change. Educators are advised to preview and evaluate websites and online resources before recommending them for student use.

Print copies of this resource can be purchased from the Manitoba Text Book Bureau (stock number 80534). Order online at <[www.mtbb.mb.ca](http://www.mtbb.mb.ca)>.

This resource is also available on the Manitoba Education website at <[www.edu.gov.mb.ca/k12/cur/science/scicurr.html](http://www.edu.gov.mb.ca/k12/cur/science/scicurr.html)>.

*Disponible en français.*

Available in alternate formats upon request

# CONTENTS

---

## Acknowledgements *vii*

## Introduction **1**

- Background 1
- Vision for Scientific Literacy 1
- Goals for Canadian Science Education 2
- Beliefs about Learning, Teaching, and Assessing Science 2
- Changing Emphases in Science 3
- Processes That Engage Students in Science Learning 5

## Section 1: Manitoba Foundations for Scientific Literacy **1**

- The Five Foundations 3
- The Nature of Science and Technology 4
- Science, Technology, Society, and the Environment (STSE) 6
- Scientific and Technological Skills and Attitudes 9
- Essential Science Knowledge 12
- The Unifying Concepts 13
- Kindergarten to Grade 10 Science and  
Grades 11 and 12 Chemistry Topic Chart 15

## Section 2: Implementation of Grade 12 Chemistry **1**

- The Senior Years Student and the Science Learning Environment 3
- Effective Teaching in Chemistry: What the Research Says to Teachers 14
- Unit Development in Chemistry 17
- A View of Chemistry Education: Toward Modes of Representation 18
- The Modes of Representation 18
- Toward an Instructional Philosophy in Chemistry 25

## Section 3: Assessment in Grade 12 Chemistry **1**

- Classroom Assessment 3
- Changing Emphases in Assessment 4
- Purposes of Assessment 5
- Assessment Strategies 7
- Planning for Assessment 10
- Characteristics of Effective Assessment 10
- Managing Classroom Assessment 15

## Section 4: Document Organization **1**

- Document Organization and Format 3
- Guide to Reading the Learning Outcomes and the Document Format 3
- Sample Two-Page Layout 6
- General Learning Outcomes 8
- Cluster 0: Skills and Attitudes Outcomes 10
- Specific Learning Outcomes 13

## Grade 12 Chemistry

- Topic 1: Reactions in Aqueous Solutions 1
- Topic 2: Atomic Structure 1
- Topic 3: Chemical Kinetics 1
- Topic 4: Chemical Equilibrium 1
- Topic 5: Acids and Bases 1
- Topic 6: Electrochemistry 1

## Appendices 1

### Topic 1 Appendices 1

- Appendix 1.1A: Developing a Set of Solubility Rules: Lab Activity 3
- Appendix 1.1B: Developing a Set of Solubility Rules: Lab Activity (Teacher Notes) 4
- Appendix 1.2: Solubility Rules 7
- Appendix 1.3: Predicting Precipitation Reactions 8
- Appendix 1.4: Colour Chart for Ions in Aqueous Solutions 10
- Appendix 1.5: Identifying Unknown Solutions (Teacher Notes and Preparation Guide) 11
- Appendix 1.6A: Process Notes for Writing Net Ionic Equations (Teacher Notes) 13
- Appendix 1.6B: Process Notes for Writing Net Ionic Equations (BLM) 14
- Appendix 1.7A: Titration: Lab Activity 15
- Appendix 1.7B: Titration: Lab Activity (Teacher Notes) 18
- Appendix 1.8: Process Notes for Balancing Neutralization Reactions 20
- Appendix 1.9A: Test Tube Mystery: Lab Activity (Guidelines) 21
- Appendix 1.9B: Test Tube Mystery: Lab Activity (Preparation Guide) 23
- Appendix 1.9C: Test Tube Mystery: Lab Activity (Teacher Key 1) 25
- Appendix 1.9D: Test Tube Mystery: Lab Activity (Teacher Key 2) 26
- Appendix 1.10A: Compare and Contrast Oxidation and Reduction 28
- Appendix 1.10B: Compare and Contrast Oxidation and Reduction (Sample Response) 29
- Appendix 1.11: Oxidation Number Rules 30
- Appendix 1.12A: Practical Applications of Redox Reactions (Research Report and Presentation) 31
- Appendix 1.12B: Practical Applications of Redox Reactions (Sample Checklist and Assessment Rubric) 33

### Topic 2 Appendices 1

- Appendix 2.1: Spectral Lines 3
- Appendix 2.2: Gas Discharge Tubes (BLM) 5
- Appendix 2.3: Flaming Salts (Demonstration) 6
- Appendix 2.4: Observing Continuous Spectra and Line Spectra 8
- Appendix 2.5: Blank Periodic Table of the Elements 9
- Appendix 2.6: Table of Electronegativity Values 10
- Appendix 2.7A: Electronegativities (BLM) 11
- Appendix 2.7B: Electronegativities (Teacher Key) 12

**Topic 3 Appendices 1**

Appendix 3.1:	Graphical Determination of Reaction Rate: Lab Activity	3
Appendix 3.2A:	Chemical Kinetics: Assignment 1	6
Appendix 3.2B:	Chemical Kinetics: Assignment 1 (Answer Key)	8
Appendix 3.3A:	Chemical Kinetics: Assignment 2	11
Appendix 3.3B:	Chemical Kinetics: Assignment 2 (Answer Key)	13
Appendix 3.4A:	Chemical Kinetics Problems	16
Appendix 3.4B:	Chemical Kinetics Problems (Answer Key)	18
Appendix 3.5A:	Factors Affecting the Rate of Reactions: Lab Activity	22
Appendix 3.5B:	Factors Affecting the Rate of Reactions: Lab Activity (Answer Key)	26
Appendix 3.6A:	Factors Affecting the Rate of a Reaction: Lab Activity	28
Appendix 3.6B:	Factors Affecting the Rate of a Reaction: Lab Activity (Teacher Notes)	31

**Topic 4 Appendices 1**

Appendix 4.1:	Preparation of Equilibrium Systems (Demonstration)	3
Appendix 4.2:	Solving Equilibrium Problems Using the ICE Table Method	5
Appendix 4.3:	Solving for $K_{\text{eq}}$ Using the BIR/PEC Accounting Method	7
Appendix 4.4:	Equilibrium Problems	9
Appendix 4.5:	Chemical Equilibrium: Lab Activity	10
Appendix 4.6A:	An Analogy for an Equilibrium Reaction: Lab Activity	13
Appendix 4.6B:	An Analogy for an Equilibrium Reaction: Lab Activity (Teacher Notes)	15
Appendix 4.6C:	An Analogy for an Equilibrium Reaction: Lab Report Checklist	16
Appendix 4.7:	Equilibrium and Le Châtelier's Principle (Pre-lab)	17
Appendix 4.8A:	Qualitative Equilibrium: Lab Activity	18
Appendix 4.8B:	Qualitative Equilibrium: Lab Activity (Teacher Notes)	19
Appendix 4.9:	Disrupting Equilibrium Systems: Lab Activity	20
Appendix 4.10:	Interpreting Equilibrium Graphs	24
Appendix 4.11:	Interpreting Concentration versus Time Graphs	27

**Topic 5 Appendices 1**

- Appendix 5.1: Selected Neutralization Indicators 3
- Appendix 5.2: Acid-Base Indicators and pH: Lab Activity 4
- Appendix 5.3A: Measuring pH: Lab Activity 6
- Appendix 5.3B: Measuring pH: Lab Activity (Teacher Notes) 8
- Appendix 5.4: Relative Strengths of Acids 9
- Appendix 5.5: Quantitative Analysis: Acid-Base Titration:  
Lab Activity 10
- Appendix 5.6: Analysis of Household Vinegar: Lab Activity 14
- Appendix 5.7: Analysis of Aspirin: Lab Activity 16
- Appendix 5.8: Potentiometric Analysis of Acid in Soft Drinks:  
Cola versus Non-cola: Lab Activity 18
- Appendix 5.9: Samples of Various Titration Curves (Teacher Notes) 23

**Topic 6 Appendices 1**

- Appendix 6.1: Activity Series: Lab Activity 3
- Appendix 6.2: Table of Standard Reduction Potentials 5

**General Appendices 1**

- Appendix 7: Scientific Communication 3
- Appendix 8: Research 11
- Appendix 9: Assessment 17
- Appendix 10: Developing Assessment Rubrics in Science 23
- Appendix 11: Assessment Rubrics 29
- Appendix 12: General and Specific Learning Outcomes 39

**Bibliography 1**



## ACKNOWLEDGEMENTS

This document is based on a draft version of *Grade 12 Chemistry: A Foundation for Implementation*, which was released on the Manitoba Education website in fall 2004. Manitoba Education gratefully acknowledges the contributions of the following individuals in the development of the draft and final documents.

<b>Principal Writers</b>	George D. Bush	Consulting Science Educator Winnipeg, Manitoba
	Elizabeth Kozoriz	Daniel McIntyre Collegiate The Winnipeg School Division
<b>Members of the Development Team</b>	Madeleine Asselin	Collège Louis-Riel Division scolaire franco-manitobaine
	George D. Bush	Consulting Science Educator Winnipeg, Manitoba
	Kelly Choy (until June 2005)	Minnedosa Collegiate Rolling River School Division
	Kris Coulter (until June 2005)	St. John's High School The Winnipeg School Division
	Leona Groot	Gimli High School Evergreen School Division
	Jennifer Kirk	Balmoral Hall School Independent Schools
	Kent Lewarne	Nellie McClung Collegiate Prairie Spirit School Division
	Angela Russenholt	J. H. Bruns Collegiate Louis Riel School Division
	Rick Wiebe	John Taylor Collegiate St. James-Assiniboia School Division
<b>Post-secondary Advisor</b>	Brian Lewthwaite	Faculty of Education University of Manitoba

**Manitoba Education**  
School Programs Division Staff

Carole Bilyk Project Manager	Development Unit Instruction, Curriculum and Assessment Branch
Louise Boissonneault Coordinator	Document Production Services Unit Educational Resources Branch
Sandra Drummond Administrative Assistant	Development Unit Instruction, Curriculum and Assessment Branch
Darryl Gervais Director	Instruction, Curriculum and Assessment Branch
Lynn Harrison Desktop Publisher	Document Production Services Unit Educational Resources Branch
Heather Knight Wells Science Consultant (from August 2011 to February 2012)	Development Unit Instruction, Curriculum and Assessment Branch
Gabe Kraljevic Science Consultant (from February 2012)	Development Unit Instruction, Curriculum and Assessment Branch
Susan Letkemann Publications Editor	Document Production Services Unit Educational Resources Branch
John Murray Science Consultant (until July 2011)	Development Unit Instruction, Curriculum and Assessment Branch
Aileen Najduch Science Consultant (until June 2005)	Instruction, Curriculum and Assessment Branch
Jacques Dorge Director (until August 2011)	Curriculum Development and Implementation Branch
Danièle Dubois-Jacques Consultant	Curriculum Development and Implementation Branch
Gilbert Michaud Director (from September 2011)	Curriculum Development and Implementation Branch

Bureau de l'éducation française  
Division Staff

# INTRODUCTION

## Background

*Grade 12 Chemistry: A Foundation for Implementation* presents student learning outcomes for Grade 12 Chemistry. These learning outcomes are the same for students in the English, French Immersion, Français, and Senior Years Technology Education Programs, and result from a partnership involving two divisions of Manitoba Education: School Programs Division and Bureau de l'éducation française Division.

Student learning outcomes are concise descriptions of the knowledge and skills [and attitudes] that students are expected to learn in a course or grade in a subject area (Manitoba Education and Training, *A Foundation for Excellence* 14).

Manitoba's student learning outcomes for Grade 12 Chemistry are based, in part, on those found within the *Common Framework of Science Learning Outcomes K to 12: Pan-Canadian Protocol for Collaboration on School Curriculum* (Council of Ministers of Education, Canada) and on those developed as components of the 1998 Manitoba Transitional Curricula. The former, commonly referred to as the *Pan-Canadian Science Framework*, was initiated under the Pan-Canadian Protocol for Collaboration on School Curriculum (1995). It was developed by educators from Manitoba, Saskatchewan, Alberta, British Columbia, the Northwest Territories, the Yukon Territory, Ontario, and the Atlantic Provinces.

*Grade 12 Chemistry: A Foundation for Implementation* provides the basis for learning, teaching, and assessing chemistry in Manitoba. This document also serves as a starting point for future development of curriculum support documents, related teacher support materials, learning resources, assessment tools, and professional learning for teachers. This document also complements the *Pan-Canadian Science Framework* by providing support for its implementation, including suggestions for instruction and assessment.

## Vision for Scientific Literacy

Factors such as global interdependence, rapid scientific and technological innovation, the need for a sustainable environment, economy, and society, and the pervasiveness of science and technology in daily life reinforce the importance of scientific literacy. Scientifically literate individuals can more effectively interpret information, solve problems, make informed decisions, accommodate change, and achieve new understandings. Science education makes possible the development of the foundations necessary to develop a functional scientific literacy and assists in building stronger futures for Canada's young people.

The *Pan-Canadian Science Framework* and *Grade 12 Chemistry: A Foundation for Implementation* support and promote an attainable and realistic vision for scientific literacy.

The [*Pan-Canadian Science Framework*] is guided by the vision that all Canadian students, regardless of gender or cultural background, will have an opportunity to develop scientific literacy. Scientific literacy is an evolving combination of the science-related attitudes, skills, and knowledge students need to develop inquiry, problem-solving, and decision-making abilities, to become lifelong learners, and to maintain a sense of wonder about the world around them.

Diverse learning experiences based on the [*Pan-Canadian Science Framework*] will provide students with many opportunities to explore, analyze, evaluate, synthesize, appreciate, and understand the interrelationships among science, technology, society, and the environment that will affect their personal lives, their careers, and their future (Council of Ministers of Education, Canada 4).

### **Goals for Canadian Science Education**

Several goals promoting the achievement of scientific literacy within Canadian science education were developed as part of the *Pan-Canadian Science Framework*. These goals are addressed through the Manitoba science curricula. It is hoped that science education will

- encourage students at all levels to develop a rational sense of wonder and curiosity about scientific and technological endeavours
- enable students to use science and technology to acquire new knowledge and to solve problems, so they may improve the quality of their own lives and the lives of others
- prepare students to address science-related societal, economic, ethical, and environmental issues critically
- provide students with a proficiency in science that creates opportunities for them to pursue progressively higher levels of advanced study, prepares them for science-related occupations, and engages them in science-related activities appropriate to their interests and abilities
- develop in students of varying aptitudes and interests a knowledge of the wide variety of careers related to science, technology, and support for the natural and human environments

### **Beliefs about Learning, Teaching, and Assessing Science**

To promote a rational, achievable approach to developing scientific literacy among future citizens, it is crucial to recognize how students learn, how science can best be taught, and how learning can be assessed. Students are curious, active learners who have individual interests, abilities, and needs. They come to school with prior knowledge and various personal and cultural experiences that generate a range of attitudes and beliefs about science and life, and connections between these realms.

Students learn most effectively when their study of science is rooted in concrete learning experiences related to a particular context or situation, and applied to their world of experiences, where appropriate. Ideas and understandings that students develop should be progressively extended and reconstructed as students grow in their experiences and in their ability to conceptualize more deeply. Learning involves the process of linking newly constructed understandings with prior knowledge, and then adding new contexts and experiences to current understandings. It is increasingly important that chemistry educators draw professional attention to how fundamental research in learning theory will affect their efforts in the science classroom.

### Changing Emphases in Science

Student learning outcomes in Grade 12 Chemistry encompass changing emphases in *science education content delivery* and changing emphases to promote *inquiry*, as envisioned in the *National Science Education Standards* (National Research Council 113).

<b>Changing Emphases in Science Education Content Delivery</b>	
The <i>National Science Education Standards</i> envision change throughout the system. The science content standards [or student learning outcomes] encompass the following changes in emphases:	
<b>Less Emphasis On</b>	<b>More Emphasis On</b>
Knowing scientific facts and information	Understanding scientific concepts and developing abilities of inquiry
Studying subject matter disciplines (physical, life, Earth sciences) for their own sake	Learning subject matter disciplines in the context of inquiry, technology, science in personal and social perspectives, and history and nature of science
Separating science knowledge and science process	Integrating all aspects of science content
Covering many science topics	Studying a few fundamental science concepts
Implementing inquiry as a set of processes	Implementing inquiry as instructional strategies, abilities, and ideas to be learned

**Changing Emphases in Science Education Content Delivery:** Reprinted with permission from *National Science Education Standards*. Copyright © 1996 by the National Academy of Sciences, courtesy of the National Academies Press, Washington, DC.

<b>Changing Emphases to Promote Inquiry</b>	
<p>The <i>National Science Education Standards</i> envision change throughout the system. The science content standards [or student learning outcomes] encompass the following changes in emphases:</p>	
<b>Less Emphasis On</b>	<b>More Emphasis On</b>
Activities that demonstrate and verify science content	Activities that investigate and analyze science questions
Investigations confined to one class period	Investigations over extended periods of time
Process skills out of context	Process skills in context
Individual process skills such as observation or inference	Using multiple process skills—manipulation, cognitive, procedural
Getting an answer	Using evidence and strategies for developing or revising an explanation
Science as exploration and experiment	Science as argument and explanation
Providing answers to questions about science content	Communicating science explanations
Individuals and groups of students analyzing and synthesizing data without defending a conclusion	Groups of students often analyzing and synthesizing data after defending conclusions
Doing a few investigations in order to leave time to cover large amounts of content	Doing more investigations in order to develop understanding, ability, values of inquiry, and knowledge of science content
Concluding inquiries with the result of the experiment	Applying the results of experiments to scientific arguments and explanations
Management of materials and equipment	Management of ideas and information
Private communication of student ideas and conclusions to teacher	Public communication of student ideas and work to classmates

**Changing Emphases to Promote Inquiry:** Reprinted with permission from *National Science Education Standards*. Copyright © 1996 by the National Academy of Sciences, courtesy of the National Academies Press, Washington, DC.

## Processes That Engage Students in Science Learning

Development of increased scientific literacy is supported by instructional environments that engage students in the following:

- **Science inquiry:** Students are encouraged to converse, ask penetrating questions, and then seek to explore their own constructed explanations alongside scientific explanations through guided research, writing, and planned investigations.
- **Problem solving:** Students apply their acquired expertise and knowledge in novel, often unforeseeable, ways.
- **Decision making:** As students identify rich, large-context problems, questions, or issues related to the human and robotic exploration of the universe around them, they pursue new knowledge that will assist them in making informed, rational, defensible decisions that are rooted in the societal and humanistic domains within which science practice operates.
- **The nature of science:** Students appreciate and value the understanding that science operates with the consent of personal, social, political, environmental, and multicultural orientations of the global society. Moreover, there are consequences when science circumvents its responsibilities among these societal contexts.
- **Science-related skills:** Examples of science-related skills include initiating, planning, performing, recording, analyzing, interpreting, communicating, and team building. All these skills have central importance in learning the dimensions of science. It is important that science students of today not be taught the myth of a single, specifiable “scientific method” that leads to a superior “truth” about the material world. If there is indeed an objective “reality,” philosophers of science often agree that it may be difficult to define, or perhaps may be unknowable. Nevertheless, the methods of science systematically permit new knowledge domains to be constructed, and that knowledge is often robust and durable.
- **Science content knowledge:** Transmission of science content is no longer considered to be the primary outcome of science teaching. Science knowledge is actively constructed from existing and emerging personal and social knowledge. Creative, integrative, and interdisciplinary linkages should be balanced with the traditional “disciplinary focus” of teaching and learning in chemistry. Unifying concepts among traditional, bounded, restricted disciplines now give way to, and add form and substance to, new views of exploration among the sciences that are holistic and interdisciplinary.

Through these processes, students discover the significance of science in their lives and come to appreciate the interrelatedness of science, technology, society, and the environment. Each of these processes can be a starting point for science learning, and may encompass the exploration of new ideas, the development of specific investigations, and the application of ideas that are learned.

To achieve the vision of a scientific literacy for all according to personal interests and inclinations, students could become increasingly more engaged in the planning, development, and evaluation of their own learning experiences. They should have opportunities to work cooperatively with other students, to initiate investigations, to communicate their findings, and to complete projects that demonstrate their learning in a personal, although peer-reviewed, manner.

At the beginning of the instructional design process, teachers and students should identify expected student learning outcomes and establish performance criteria. It is important that these criteria correspond with provincial learning outcomes. This communication between students and teachers helps identify clearly what needs to be accomplished, thereby assisting in the learning process. (See Appendix 11 for related rubrics.)

When students are aware of expected learning outcomes, they will be more focused on their learning, and may be more likely to assess their own progress. Furthermore, they can participate in creating appropriate assessment and evaluation criteria. Assessment methods must be valid, reliable, and fair to students.



# SECTION 1:

## MANITOBA FOUNDATIONS FOR SCIENTIFIC LITERACY

---

The Five Foundations	3
The Nature of Science and Technology	4
Science, Technology, Society, and the Environment (STSE)	6
Scientific and Technological Skills and Attitudes	9
Essential Science Knowledge	12
The Unifying Concepts	13
Kindergarten to Grade 10 Science and Grades 11 and 12 Chemistry Topic Chart	15



# MANITOBA FOUNDATIONS FOR SCIENTIFIC LITERACY

## The Five Foundations

To develop scientifically literate students, Manitoba science curricula are built upon five foundations for scientific literacy that have been adapted from the *Pan-Canadian Science Framework* to address the needs of Manitoba students:

- Nature of Science and Technology
- Science, Technology, Society, and the Environment (STSE)
- Scientific and Technological Skills and Attitudes
- Essential Science Knowledge
- Unifying Concepts

The following conceptual organizer illustrates the five foundations for scientific literacy representing the goals of science learning from Kindergarten to Grade 12 in Manitoba.

## Manitoba Science Curriculum Conceptual Organizer

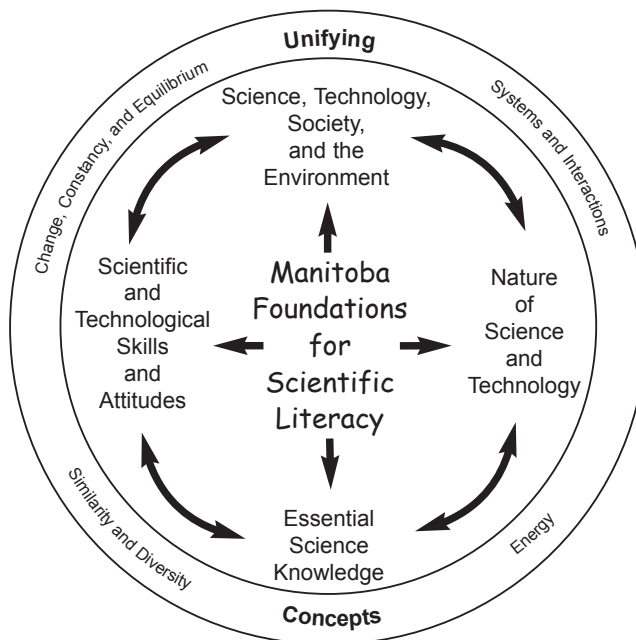

These foundations, which are described in more detail on the following pages, have led to the development of the general learning outcomes identified for Grade 12 Chemistry.

## The Nature of Science and Technology

Students learn that science and technology are creative human activities with long histories in all cultures. Science is a way of learning about the universe. This learning stems from curiosity, creativity, imagination, intuition, exploration, observation, replication of experiments, interpretation of evidence, and debate over that evidence and its interpretations. Scientific activity involves predicting, interpreting, and explaining natural and human-made phenomena. Many historians, sociologists, and philosophers of science presently argue that there is no definable, set procedure for conducting a scientific investigation. Rather, they see science as driven by a combination of theoretical concerns, knowledge, experiments, and processes anchored in the physical world.

Producing science knowledge is an intrinsically collective endeavour. There is no such thing as stand-alone science done in isolation. Scientists submit models and solutions for the assessment of their peers, who judge their logical, rational and experimental soundness through reference to the body of existing knowledge and modes of representation (Larochelle and Désautels 235).

Scientific theories are being tested, modified, and refined continually as new knowledge and theories supersede existing knowledge bases. Scientific debate, both on new observations and on hypotheses that challenge accepted knowledge, involves many participants with diverse backgrounds. This highly complex interplay, which has occurred throughout history, is animated by theoretical discussions; experimentation; social, cultural, economic, and political influences; personal biases; and the need for peer recognition and acceptance. Students will realize that while some of our understandings about how the world works are due to revolutionary scientific developments, many of our understandings result from the steady and gradual accumulation of knowledge. History demonstrates, however, that great advances in scientific thought have completely uprooted certain disciplines, transplanting practitioners and theoreticians alike into an entirely new set of guiding assumptions. Such scientific revolutions, as discussed by Thomas S. Kuhn in his influential *The Structure of Scientific Revolutions*, constitute exemplars that can energize the science teaching enterprise – particularly in chemistry education.

Technology results mainly from proposing solutions to problems arising from human attempts to adapt to the external environment. Technology may be regarded as “a tool or machine; a process, system, environment, epistemology, and ethic; the systematic application of knowledge, materials, tools, and skills to extend human capabilities” (Manitoba Education and Training, *Technology As a Foundation Skill Area 1*). Technology refers to much more than the knowledge and skills related to computers and their applications. Technology is based on the knowledge of concepts and skills from other disciplines (including science), and is the application of this knowledge to meet an identified need or to solve a problem using materials, energy, and tools (including computers). Technology also has an influence on processes and systems, on society, and on the ways people think, perceive, and define their world.

Grade 12 Chemistry emphasizes both the distinctions and relationships between science and technology. The following illustration shows how science and technology differ in purpose, procedure, and product, while at the same time relating to each other.

**Science and Technology: Their Nature and Interrelationships\***

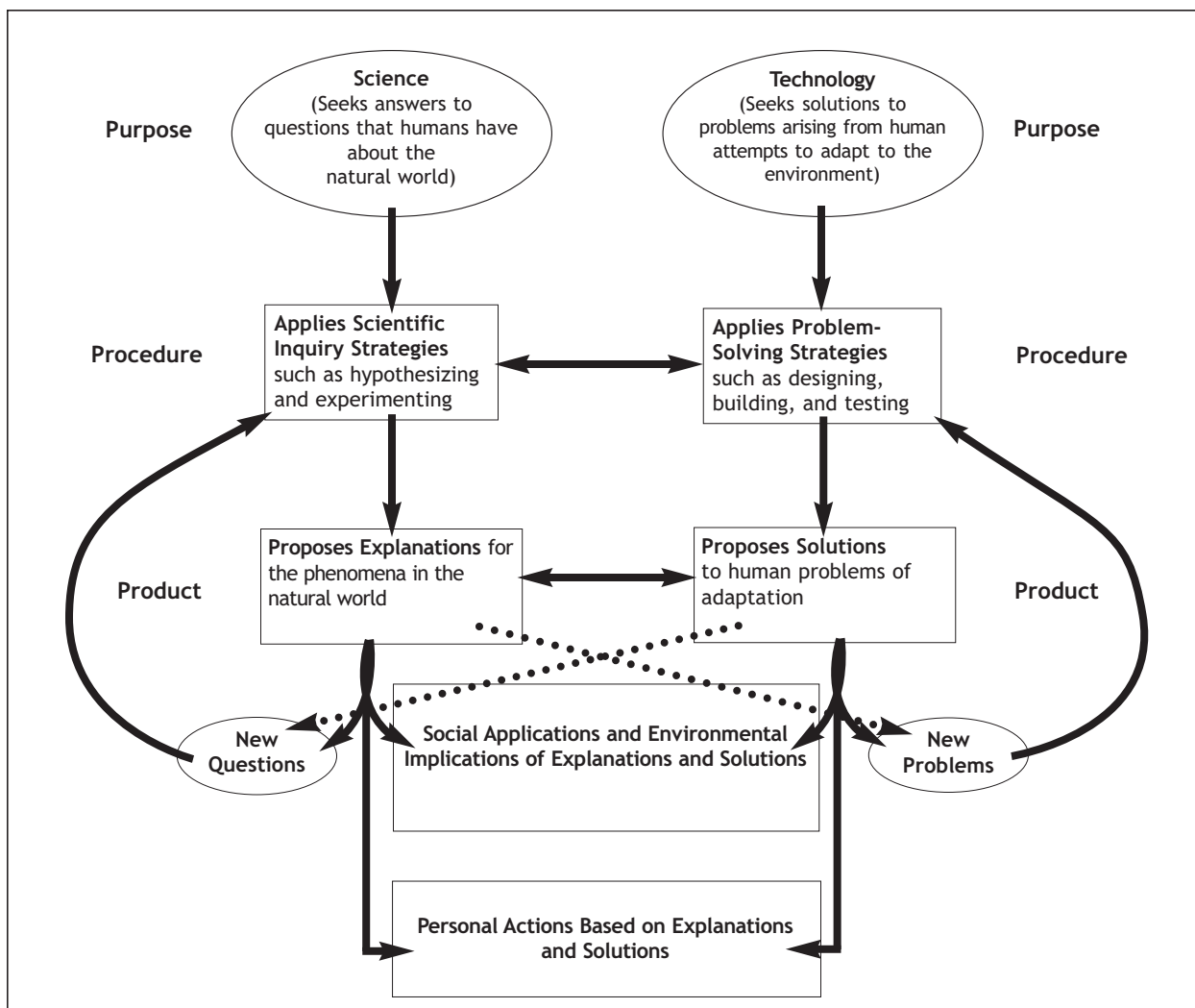

\* Source: Bybee, Rodger W., et al. *Science and Technology Education for the Elementary Years: Frameworks for Curriculum and Instruction*. Rowley, MA: The NETWORK, Inc., 1989. Adapted with permission.

The following general learning outcomes (GLOs) have been developed to define expectations related to the Nature of Science and Technology foundation area. (For a complete listing of the general and specific learning outcomes, see Appendix 12.)

---

### **Nature of Science and Technology General Learning Outcomes**

As a result of their Senior Years science education, students will:

- A1** Recognize both the power and limitations of science as a way of answering questions about the world and explaining natural phenomena.
  - A2** Recognize that scientific knowledge is based on evidence, models, and explanations, and evolves as new evidence appears and new conceptualizations develop.
  - A3** Distinguish critically between science and technology in terms of their respective contexts, goals, methods, products, and values.
  - A4** Identify and appreciate contributions made by women and men from many societies and cultural backgrounds that have increased our understanding of the world and brought about technological innovations.
  - A5** Recognize that science and technology interact with and advance one another.
- 

### **Science, Technology, Society, and the Environment (STSE)**

Understanding the complex interrelationships among science, technology, society, and the environment is an essential component of fostering increased scientific literacy. By studying the historical context, students come to appreciate ways in which cultural and intellectual traditions have influenced the questions and methodologies of science, and how science, in turn, has influenced the wider world of ideas.

Today, most scientists work in industry, where projects are more often driven by societal and environmental needs than by pure research. Many technological solutions have evoked complex social and environmental issues. Students recognize the potential of scientific literacy to inform and empower decision making of individuals, communities, and society as a whole.

Scientific knowledge is necessary, but not sufficient, for understanding the relationships among science, technology, society, and the environment. To understand these relationships fully, it is essential that students consider the values related to science, technology, society, and the environment.

### **Sustainable Development as a Decision-Making Model**

As a component of achieving scientific literacy, students must also develop an appreciation for the importance of sustainable development. Sustainable development is a decision-making model that considers the needs of both present and future generations, and integrates and balances the *health and well-being of the community, the environment, and the impact of economic activities.*

- *Sustainable human health and well-being* is characterized by people coexisting harmoniously within local, national, and global communities, and with nature. A sustainable society is one that is physically, psychologically, spiritually, and socially healthy. The well-being of individuals, families, and communities is of considerable importance.

- A *sustainable environment* is one in which the life-sustaining processes and natural resources of the Earth are conserved and regenerated.
- A *sustainable economy* is one that provides equitable access to resources and opportunities. It is characterized by development decisions, policies, and practices that respect cultural realities and differences, and do not exhaust the Earth's resources. A sustainable economy is evident when decisions, policies, and practices are carried out to minimize their impact on the Earth's resources and to maximize the regeneration of the natural environment.
- Decisions or changes related to any one of the three components – human health and well-being, the environment, or the economy – have a significant impact on the other two components and, consequently, on our *quality of life*. Decision making must take into account all three components to ensure an equitable, reasonable, and sustainable quality of life for all.

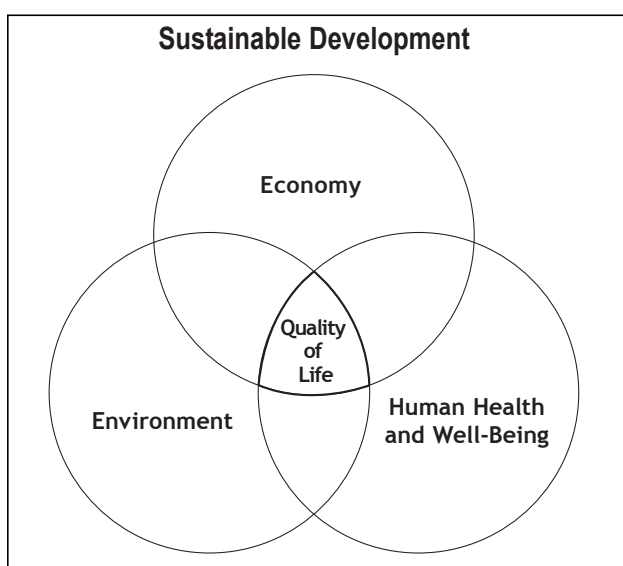

Educators are encouraged to consult *Education for a Sustainable Future* (Manitoba Education and Training), a document that outlines ways of incorporating precepts, principles, and practices to foster appropriate learning environments that would help direct students toward a sustainable future. The document is available online at <[www.edu.gov.mb.ca/k12/docs/support/future](http://www.edu.gov.mb.ca/k12/docs/support/future)>.

### **Sustainable Development, Social Responsibility, and Equity**

Sustainable development supports principles of social responsibility and equity. Robin Williams believes that the concept of equity is essential to the attainment of sustainability. This includes equity among nations, within nations, between humans and other species, as well as between present and future generations.

Sustainable development is, at the same time, a decision-making process, a way of thinking, a philosophy, and an ethic. Compromise is an important idea that underlies the decision-making process within a sustainable development approach. In order to achieve the necessary balance among human health and well-being, the environment, and the economy, some compromises will be necessary.

There can be no greater contribution or more essential element to long-term environmental strategies leading to sustainable development that respects the environment... than the education of future generations in matters relating to the environment (UNESCO).

Public awareness and understanding of the concept of sustainable development and its practices are essential. If we are to change our way of life we must equip present and future generations with the knowledge and training to put sustainable development into effect (Manitoba Sustainability Development Coordination Unit 19).

As students advance from grade to grade, they identify STSE interrelationships and apply decision-making skills in increasingly demanding contexts, such as the following:

- **Complexity of understanding:** from simple, concrete ideas to abstract ideas; from limited knowledge of science to more in-depth and broader knowledge of science and the world
- **Applications in context:** from contexts that are local and personal to those that are societal and global
- **Consideration of variables and perspectives:** from one or two that are simple to many that are complex
- **Critical judgement:** from simple right or wrong assessments to complex evaluations
- **Decision making:** from decisions based on limited knowledge, made with the teacher's guidance, to decisions based on extensive research that are made independently and involve personal judgement

The following GLOs have been developed to define expectations related to the STSE foundation area.

---

### **Science, Technology, Society, and the Environment (STSE) General Learning Outcomes**

As a result of their Senior Years science education, students will:

- B1** Describe scientific and technological developments—past and present—and appreciate their impact on individuals, societies, and the environment, both locally and globally.
  - B2** Recognize that scientific and technological endeavours have been and continue to be influenced by human needs and the societal context of the time.
  - B3** Identify the factors that affect health, and explain the relationships among personal habits, lifestyle choices, and human health, both individual and social.
  - B4** Demonstrate a knowledge of and personal consideration for a range of possible science- and technology-related interests, hobbies, and careers.
  - B5** Identify and demonstrate actions that promote a sustainable environment, society, and economy, both locally and globally.
-



## Scientific and Technological Skills and Attitudes

A science education that strives for developing scientific literacy must engage students in answering questions, solving problems, and making decisions. These processes are referred to as scientific inquiry, technological problem solving (the design process), and decision making (see the following chart). While the skills and attitudes involved in these processes are not unique to science, they play an important role in the development of scientific understandings and in the application of science and technology to new situations.

<b>Processes for Science Education*</b>			
	<b>Scientific Inquiry</b>	<b>Technological Problem Solving (Design Process)</b>	<b>Decision Making</b>
<b>Purpose:</b>	Satisfying curiosity about events and phenomena in the natural world.	Coping with everyday life, practices, and human needs.	Identifying different views or perspectives based on varying information.
<b>Procedure:</b>	What do we know? What do we want to know?	How can we do it? Will it work?	What are the alternatives or consequences? Which choice is best at this time?
<b>Product:</b>	Knowledge about events and phenomena in the natural world.	An effective and efficient way to accomplish a task or meet a need.	A defensible decision in a particular circumstance.

	<b>Scientific Question</b>	<b>Technological Problem</b>	<b>STSE Issue</b>
<b>Example:</b>	Why does my coffee cool so quickly?  <i>An Answer:</i> Heat energy is transferred by conduction, convection, and radiation to the surrounding environment.	How can I keep my coffee hot?  <i>A Solution:</i> A foam cup will keep liquids warm for a long time. So will an insulated cup.	Should we use foam cups or ceramic mugs for our meeting?  <i>A Decision:</i> Since we must use disposable cups for the meeting, we will choose a biodegradable type.

\* Source: © Alberta Education, *Integrated Occupational Program: Teacher Resource Manual, Science 8 and 9*, 1989. Adapted with permission.

A description of each of these *processes* follows. *Attitudes*, which are an important element of each process, are also examined, and are treated as indicators along the pathway of student achievement. Hence, attitudes are to be modelled by teachers and students, but are not formally assessed in the same manner as other specific learning outcomes.

### Scientific Inquiry

Scientific inquiry is a way of learning about the universe. It involves posing questions and searching for explanations of phenomena. Although no single “scientific method” exists, students require certain skills to participate in science-related experiences using a variety of appropriate methods.

Skills such as questioning, observing, inferring, predicting, measuring, hypothesizing, classifying, designing experiments, and collecting, analyzing, and interpreting data are fundamental to scientific inquiry – as are attitudes such as curiosity, skepticism, and creativity. These skills are often represented as a cycle. This cycle involves posing questions, generating possible explanations, and collecting and analyzing evidence to determine which of these explanations is most useful and accurate in accounting for the phenomena under investigation. New questions may arise to reignite the cycle. It must be noted, however, that many scientific inquiries (past and present) do not necessarily follow a set sequence of steps, nor do they always start at the “beginning” of the cycle; scientists can be creative and responsive to scientific challenges as they arise.

### Technological Problem Solving

Technological problem solving seeks solutions to problems arising from human attempts to adapt to or change the environment. In Kindergarten to Grade 8 science, students have been developing these skills using a cycle of steps called the *design process*. This design process includes the proposing, creating, and testing of prototypes, products, and techniques in an attempt to reach an optimal solution to a given problem. Feedback and evaluation are built into this cycle. In Senior Years science, these technological problem-solving skills are incorporated into a *decision-making process*.

### STSE Issues and Decision Making

Students, as individuals and global citizens, are required to make decisions. Increasingly, the types of issues they face demand an ability to apply scientific and technological knowledge, processes, and products to the decisions they make related to STSE. The decision-making process involves a series of steps, which may include

- clarifying the issue
- critically evaluating all available research
- generating possible courses of action
- making a thoughtful decision
- examining the impact of the decision
- reflecting on the process

Students should be actively involved in decision-making situations as they progress through their science education. Not only are decision-making situations important in their own right, but they also provide a relevant context for engaging in scientific inquiry, problem solving, and the study of STSE relationships (as shown in the following illustration).

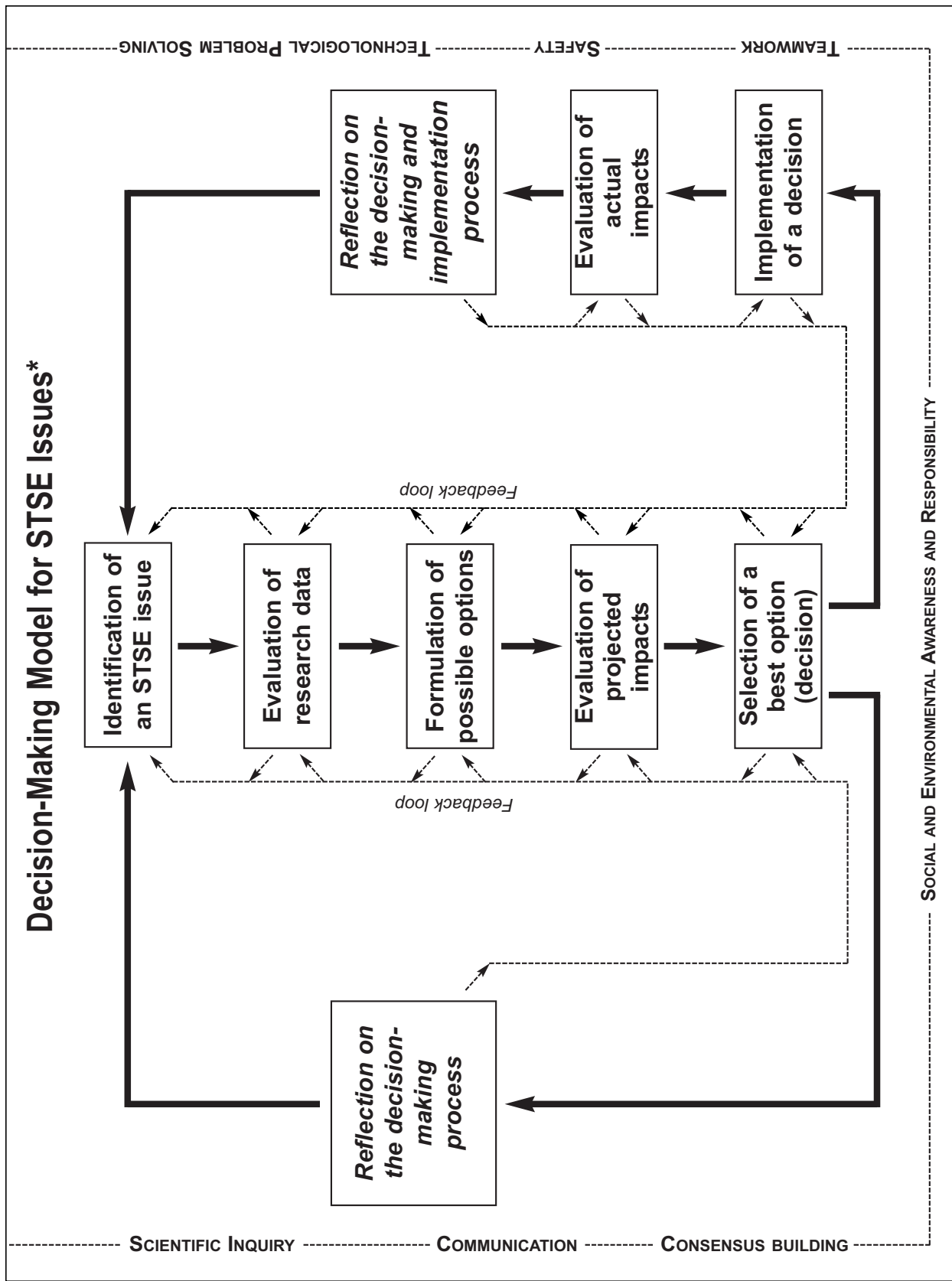

\* Source: Manitoba Education and Youth. *Senior 2 Science: A Foundation for Implementation*. Winnipeg, MB: Manitoba Education and Youth, 2003. Reprinted from Introduction, p. 12.

## Attitudes

Attitudes refer to generalized aspects of behaviour that are modelled for students. Attitudes are not acquired in the same way as skills and knowledge. They cannot be observed at any particular moment, but are evidenced by regular, unprompted manifestations over time. Development of attitudes is a lifelong process that involves the home, the school, the community, and society at large. The development of positive attitudes plays an important role in students' growth, affecting their intellectual development and creating a readiness for responsible application of what they learn.

The following GLOs have been developed to define expectations related to the Scientific and Technological Skills and Attitudes foundation area.

---

## Scientific and Technological Skills and Attitudes General Learning Outcomes

As a result of their Senior Years science education, students will:

- C1** Recognize safety symbols and practices related to scientific and technological activities and to their daily lives, and apply this knowledge in appropriate situations.
- C2** Demonstrate appropriate scientific inquiry skills when seeking answers to questions.
- C3** Demonstrate appropriate problem-solving skills when seeking solutions to technological challenges.
- C4** Demonstrate appropriate critical thinking and decision-making skills when choosing a course of action based on scientific and technological information.
- C5** Demonstrate curiosity, skepticism, creativity, open-mindedness, accuracy, precision, honesty, and persistence, and appreciate their importance as scientific and technological habits of mind.
- C6** Employ effective communication skills and use information technology to gather and share scientific and technological ideas and data.
- C7** Work cooperatively and value the ideas and contributions of others while carrying out scientific and technological activities.
- C8** Evaluate, from a scientific perspective, information and ideas encountered during investigations and in daily life.

---

## Essential Science Knowledge

The subject matter of science includes theories, models, concepts, and principles that are essential to an understanding of life sciences, physical sciences, and Earth and space sciences. Content is a vehicle for essential learnings (Drake), and it will be increasingly important for students of chemistry to make interdisciplinary connections among the following.

- **Life sciences:** This study deals with the growth and interactions of life forms within their environment in ways that reflect their uniqueness, diversity, genetic continuity, and changing nature. Life sciences include the study of organisms (including humans and cells), ecosystems, biodiversity, biochemistry, and biotechnology.

- **Physical sciences:** Primarily associated with chemistry and physics, the physical sciences deal with matter, energy, and forces. Matter has structure, and interactions exist among its components. Energy links matter to gravitational, electromagnetic, and nuclear forces of the universe. The laws of conservation of mass and energy, momentum, and charge are addressed by physical science.
- **Geosciences and the space sciences:** These studies provide students with local, global, and universal perspectives. Earth exhibits form, structure, and patterns of change, as does our surrounding solar system and the physical universe beyond. Earth and space sciences include fields of study such as geology, hydrology, meteorology, and astronomy.

The following GLOs have been developed to define expectations related to the Essential Science Knowledge foundation area.

---

### Essential Science Knowledge General Learning Outcomes

As a result of their Senior Years science education, students will:

- D1** Understand essential life structures and processes pertaining to a wide variety of organisms, including humans.
- D2** Understand various biotic and abiotic components of ecosystems, as well as their interaction and interdependence within ecosystems and within the biosphere as a whole.
- D3** Understand the properties and structures of matter, as well as various common manifestations and applications of the actions and interactions of matter.
- D4** Understand how stability, motion, forces, and energy transfers and transformations play a role in a wide range of natural and constructed contexts.
- D5** Understand the composition of the Earth's atmosphere, hydrosphere, and lithosphere, as well as the processes involved within and among them.
- D6** Understand the composition of the universe, the interactions within it, and the implications of humankind's continued attempts to understand and explore it.

---

### The Unifying Concepts

An effective way to create linkages within and among science disciplines is to use unifying concepts—the key ideas that underlie and integrate all science knowledge and extend into areas such as mathematics and social studies. Unifying concepts help students construct a more holistic, systems-related understanding of science and its role in society.

The following four unifying concepts were used in the development of Grade 12 Chemistry:

- **Similarity and diversity:** The concepts of similarity and diversity provide tools for organizing our experiences with the world. Beginning with informal experiences, students learn to recognize attributes of materials, organisms, and events that help to make useful distinctions between and among them. Over time, students adopt accepted procedures and protocols for describing and classifying objects, organisms, and events they encounter, thus enabling them to share ideas with others and to reflect on their own experiences.

- **Systems and interactions:** An important part of understanding and interpreting the world is the ability to think about the whole in terms of its parts and, alternately, about parts in terms of how they relate to one another and to the whole. A system is a collection of components that interact with one another so that the overall effect is often different from that of the individual parts, even when these are considered together. Students will study both natural and technological systems.
- **Change, constancy, and equilibrium:** The concepts of constancy and change underlie most understandings of the natural and technological world. Through observations, students learn that some characteristics of living things, materials, and systems remain constant over time, whereas others change. Through formal and informal studies, students develop an understanding of the processes and conditions in which change, constancy, and equilibrium take place.
- **Energy:** The concept of energy provides a conceptual understanding that brings together many aspects of natural phenomena, materials, and the processes of change. Energy, whether transmitted or transformed, is the driving force of both movement and change. Students learn to describe energy in terms of its effects and, over time, develop a concept of energy as something inherent within the interactions of materials, the processes of life, and the functions of systems.

The following GLOs have been developed to define expectations related to the Unifying Concepts foundation area.

---

### **Unifying Concepts General Learning Outcomes**

As a result of their Senior Years science education, students will:

- E1** Describe and appreciate the similarity and diversity of forms, functions, and patterns within the natural and constructed world.
  - E2** Describe and appreciate how the natural and constructed world is made up of systems and how interactions take place within and among these systems.
  - E3** Recognize that characteristics of materials and systems can remain constant or change over time, and describe the conditions and processes involved.
  - E4** Recognize that energy, whether transmitted or transformed, is the driving force of both movement and change, and is inherent within materials and in the interactions among them.
-

## Kindergarten to Grade 10 Science and Grades 11 and 12 Chemistry Topic Chart

The following table provides a quick reference to the different thematic clusters from Kindergarten to Grade 10 Science and Grades 11 and 12 Chemistry. It allows teachers to examine, at a glance, students' previous exposure to scientific knowledge in different areas. The chemistry-related content clusters are grey-shaded for reference.

Science	Cluster 0	Cluster 1	Cluster 2	Cluster 3	Cluster 4	
Kindergarten	Overall Skills and Attitudes (To Be Integrated into Clusters 1 to 4)	Trees	Colours	Paper	---	
Grade 1		Characteristics and Needs of Living Things	The Senses	Characteristics of Objects and Materials	Daily and Seasonal Changes	
Grade 2		Growth and Changes in Animals	Properties of Solids, Liquids, and Gases	Position and Motion	Air and Water in the Environment	
Grade 3		Growth and Changes in Plants	Materials and Structures	Forces That Attract or Repel	Soils in the Environment	
Grade 4		Habitats and Communities	Light	Sound	Rocks, Minerals, and Erosion	
Grade 5		Maintaining a Healthy Body	Properties of and Changes in Substances	Forces and Simple Machines	Weather	
Grade 6		Diversity of Living Things	Flight	Electricity	Exploring the Solar System	
Grade 7		Interactions within Ecosystems	Particle Theory of Matter	Forces and Structures	Earth's Crust	
Grade 8		Cells and Systems	Optics	Fluids	Water Systems	
Grade 9		Reproduction	Atoms and Elements	Nature of Electricity	Exploring the Universe	
Grade 10		Dynamics of Ecosystems	Chemistry in Action	In Motion	Weather Dynamics	
Grade 11 Chemistry		Topics: Physical Properties of Matter, Gases and the Atmosphere, Chemical Reactions, Solutions, and Organic Chemistry				
Grade 12 Chemistry		Topics: Reactions in Aqueous Solutions, Atomic Structure, Kinetics, Chemical Equilibrium, Acids and Bases, and Electrochemistry				

## NOTES



## SECTION 2:

# IMPLEMENTATION OF GRADE 12 CHEMISTRY

---

The Senior Years Student and the Science Learning Environment	3
Effective Teaching in Chemistry: What the Research Says to Teachers	14
Unit Development in Chemistry	17
A View of Chemistry Education: Toward Modes of Representation	18
The Modes of Representation	18
Toward an Instructional Philosophy in Chemistry	25



# IMPLEMENTATION OF GRADE 12 CHEMISTRY

## The Senior Years Student and the Science Learning Environment

Each year, teachers are called upon to make many decisions regarding course content, learning materials and resources, and instructional and assessment methods. Successful learning is more likely to occur if these decisions are informed by teachers' understanding of their students and the ways they learn.

Teachers seeking to learn about their students need to be knowledgeable in various areas, including the following:

- **How people learn:** In recent decades, cognitive psychology, brain-imaging technology, and multiple intelligences theory have transformed our understanding of learning. Ongoing professional learning is important to teachers as they seek to update their knowledge of the processes of learning.
- **Ways in which student populations are changing:** The students whom teachers encounter today are different in many respects from students a generation ago. Students are more likely to be living with a single parent or stepfamily. More have part-time jobs. Students are more sophisticated in their knowledge and use of information technology, and much of their understanding of the world comes from television. Classrooms are more likely to be ethnically diverse.
- **Developmental characteristics of students:** The characteristics of adolescent learners have many implications for teachers.
- **The unique qualities of each student:** Family relationships, academic and life experiences, personality, interests, learning approaches, socio-economic status, and rate of development all influence a student's ability to learn. Teachers can gain an understanding of the unique qualities of each student only through daily interaction, observation, and assessment.

## Characteristics of Grade 12 Learners\*

For many students, Grade 12 is a stable and productive year. Many Grade 12 students have developed a degree of security within their peer group and a sense of belonging in school. They show increasing maturity in dealing with the freedoms and responsibilities of late adolescence: romantic relationships, part-time jobs, and a driver's licence. In Grade 12, most students have a great deal of energy and a growing capacity for abstract and critical thinking. Many are prepared to express themselves with confidence and to take creative and intellectual risks. The stresses and preoccupations of preparing for graduation, post-secondary education, or full-time jobs are still a year away. For many students, Grade 12 may be the most profitable academic year of the Senior Years.

---

\* Source: Manitoba Education and Training. *Senior 4 English Language Arts: A Foundation for Implementation*. Winnipeg, MB: Manitoba Education and Training, 2000. Adapted from Section 3, pp. 7-8.

Although many Grade 12 students handle their new responsibilities and the demands on their time with ease, others experience difficulty. External interests may seem more important than school. Because of their increased autonomy, students who previously had problems managing their behaviour at school may now express their difficulties through poor attendance, alcohol and drug use, or other behaviours that place them at risk.

Students struggling to control their lives and circumstances may make choices that seem to teachers to be contrary to their best interests. Communication with the home and awareness of what their students are experiencing outside school continue to be important for Grade 12 teachers. Although the developmental variance evident in previous years has narrowed, students in Grade 12 can still change a great deal in the course of one year or even one semester. Teachers need to be sensitive to the dynamic classroom atmosphere and recognize when shifts in interests, capabilities, and needs are occurring, so they can adjust learning experiences for their students.

The following chart identifies some common characteristics of late adolescence observed in educational studies (Glatthorn; Maxwell and Meiser; Probst) and by Manitoba teachers, and discusses the implications of these characteristics for teachers.

<b>Grade 12 Learners: Implications for Teachers*</b>	
<b>Characteristics of Grade 12 Learners</b>	<b>Significance for Grade 12 Teachers</b>
<b>Cognitive Characteristics</b>	
<ul style="list-style-type: none"> <li>• Most Grade 12 learners are capable of abstract thought and are in the process of revising their former concrete thinking into fuller understanding of principles.</li> <li>• Students are less absolute in their reasoning, more able to consider diverse points of view. They recognize that knowledge may be relative to context.</li> <li>• Many basic learning processes have become automatic by Grade 12, freeing students to concentrate on complex learning.</li> <li>• Students have a clearer self-understanding and have developed specialized interests and expertise. They need to connect what they are learning to the world outside the school. Chemistry must be seen as valuable and necessary.</li> </ul>	<ul style="list-style-type: none"> <li>• Teach to the big picture. Help students forge links between what they already know and what they are learning. Be cognizant of individual differences and build bridges for students who think concretely.</li> <li>• Focus on developing problem-solving and critical thinking skills, particularly those related to STSE and decision making.</li> <li>• Identify the knowledge, skills, and strategies that students already possess, and build the course around new challenges. Through assessment, identify students who have not mastered learning processes at Grade 12 levels and provide additional assistance and support.</li> <li>• Use strategies that enhance students' metacognition. Encourage students to develop scientific skills through exploring areas of interest. Cultivate classroom experts and invite students with individual interests to enrich the learning experience of the class.</li> </ul>

(continued)

\* Source: Manitoba Education and Training. *Senior 4 English Language Arts: A Foundation for Implementation*. Winnipeg, MB: Manitoba Education and Training, 2000. Adapted from Section 3, pp. 9-11.

<b>Grade 12 Learners: Implications for Teachers (continued)</b>	
<b>Characteristics of Grade 12 Learners</b>	<b>Significance for Grade 12 Teachers</b>
<b>Psychological and Emotional Characteristics</b>	
<ul style="list-style-type: none"> <li>• It is important for Grade 12 students to see that their autonomy and emerging independence are respected. They need a measure of control over what happens to them in school.</li> <li>• Students are preparing for senior leadership roles within the school and may be more involved with leadership in their communities.</li> <li>• Students need to understand the purpose and relevance of practices, policies, and processes. They may express their growing independence through a general cynicism about authority and institutions.</li> <li>• Grade 12 students have a clearer sense of identity than they had previously and are capable of being more reflective and self-aware. Some students are more willing to express themselves and disclose their thoughts and ideas.</li> </ul>	<ul style="list-style-type: none"> <li>• Provide choice. Allow students to select many of the resources they will explore and the forms they will use to demonstrate their learning. Collaborate with students in assessment. Teach students to be independent learners. Gradually release responsibility to students.</li> <li>• Provide students with leadership opportunities within the classroom and with a forum to practise skills in public speaking and group facilitation.</li> <li>• Use students' tendency to question social mores to help them develop critical thinking. Negotiate policies and demonstrate a willingness to make compromises. Use students' questions to fuel classroom inquiry.</li> <li>• Provide optional and gradual opportunities for self-disclosure. Invite students to explore and express themselves through their work. Celebrate student differences.</li> </ul>
<b>Physical Characteristics</b>	
<ul style="list-style-type: none"> <li>• Many Grade 12 students have reached adult physical stature. Others, particularly males, are still in a stage of extremely rapid growth and experience a changing body image and self-consciousness.</li> <li>• By Grade 12, students are better able to sit still and concentrate on one learning task for longer periods, but they still need interaction and variety. They have a great deal of energy.</li> <li>• Grade 12 students still need more sleep than adults do, and may come to school tired as a result of part-time jobs or activity overload.</li> </ul>	<ul style="list-style-type: none"> <li>• Be sensitive to the risk students may feel in public performances and increase expectations gradually. Provide students with positive information about themselves.</li> <li>• Put physical energy to the service of active learning instead of trying to contain it. Provide variety; change the pace frequently; use kinesthetic learning experiences.</li> <li>• Be aware that inertia or indifference may be the result of fatigue. Work with students and families to set goals and plan activities realistically so that school work assumes a higher priority.</li> </ul>

*(continued)*

<b>Grade 12 Learners: Implications for Teachers (continued)</b>	
<b>Characteristics of Grade 12 Learners</b>	<b>Significance for Grade 12 Teachers</b>
<b>Moral and Ethical Characteristics</b>	
<ul style="list-style-type: none"> <li>• Grade 12 students are working at developing a personal ethic, rather than following a prescribed set of values and code of behaviour.</li> <li>• Students are sensitive to personal or systemic injustice but are increasingly realistic about the factors affecting social change.</li> <li>• Students are shifting from an egocentric view of the world to one centred in relationships and community. They are able to recognize different points of view and adapt to difficult situations.</li> <li>• Students are becoming realistic about the complexities of adult responsibilities but resist arbitrary authority.</li> </ul>	<ul style="list-style-type: none"> <li>• Explore the ethical meaning of situations in life and in scientific contexts. Provide opportunities for students to reflect on their thoughts in discussion, writing, or representation.</li> <li>• Explore ways in which decision-making activities can effect social change, and link to the continuum of science, technology, society, and the environment.</li> <li>• Provide opportunities for students to make and follow through on commitments and to refine their interactive skills.</li> <li>• Explain the purpose of every learning experience. Enlist student collaboration in developing classroom policies. Strive to be consistent.</li> </ul>
<b>Social Characteristics</b>	
<ul style="list-style-type: none"> <li>• By Grade 12, certain individuals will take risks in asserting an individual identity. Many students, however, continue to be intensely concerned with how peers view their appearance and behaviour. Much of their sense of self is drawn from peers, with whom they may adopt a “group consciousness,” rather than from making autonomous decisions.</li> <li>• Adolescents frequently express identification with peer groups through slang, musical choices, clothing, body decoration, and behaviour.</li> <li>• Crises of friendship and romance, and a preoccupation with relationships, can distract students from academics.</li> <li>• Students begin to recognize teachers as individuals and welcome a personal connection.</li> </ul>	<ul style="list-style-type: none"> <li>• Ensure that the classroom has an accepting climate. Model respect for each student. Use learning experiences that foster student self-understanding and self-reflection. Challenge students to make personal judgements about situations in life and in their natural environment.</li> <li>• Foster a classroom identity and culture. Ensure that every student is included and valued. Structure learning so that students can interact with peers, and teach strategies for effective interaction.</li> <li>• Open doors for students to study personal relationships in science (for example, through biographies of scientists). Respect confidentiality, except where a student’s safety is at risk.</li> <li>• Nurture and enjoy a relationship with each student. Try to find areas of common interest with each one. Respond with openness, empathy, and warmth.</li> </ul>

**Fostering a Will to Learn: Creating Links between Language and Science\***

Experiences of intense involvement are optimal opportunities to teach engagement in learning, and teachers should try to ensure they happen frequently in the classroom. Not every learning task, however, can be intrinsically rewarding to every learner. Being a successful learner also requires a high degree of what Corno and Randi call “sustained voluntary effort” – an attitude expressed in committing oneself to less interesting tasks, persisting in solving problems, paying conscientious attention to detail, managing time, self-monitoring, and making choices between competing values, such as the desire to do well on a homework assignment and the desire to spend the evening with friends. The willingness to make this sustained effort constitutes motivation.

Motivation is a concern of teachers, not only because it is essential to classroom learning, but also because volition and self-direction are central to lifelong learning. Science courses seek to teach students how to interpret and analyze science concepts, and to foster the desire to do so. Motivation is not a single factor that students either bring or do not bring to the classroom. It is multi-dimensional, individual, and often comprises both intrinsic and extrinsic elements. Students hold certain presuppositions about science learning that affect the way they learn. Teachers can promote certain attitudes and skills to facilitate students’ engagement in each learning task, while recognizing and affirming entry-level abilities.

In considering how they can foster motivation, teachers may explore students’ appreciation of the value (intrinsic and extrinsic) of learning experiences and their belief about their likelihood of success. These two elements can be expressed as an equation; the effort students are willing to expend on a task is a product of their expectation of success and of the value they ascribe to success (Good and Brophy).

<b>Expectancy</b>	<b>x</b>	<b>Value</b>	<b>=</b>	<b>Motivation</b>
(the degree to which students expect to be able to perform the tasks successfully if they apply themselves)		(the degree to which students value the rewards of performing a task successfully)		

Teachers may, therefore, want to focus on ensuring that students are able to succeed if they apply reasonable effort, and on helping students recognize the value of classroom learning experiences. The following chart provides teachers with suggestions for fostering motivation.

\* Source: Manitoba Education and Training. *Senior 4 English Language Arts: A Foundation for Implementation*. Winnipeg, MB: Manitoba Education and Training, 2000. Adapted from Section 2, p. 19.

<b>Fostering Motivation*</b>	
<b>Ways to Foster Expectations of Success</b>	<b>Best Practice and Research</b>
<ul style="list-style-type: none"> <li>• Help students to develop a sense of self-efficacy.</li> </ul>	<ul style="list-style-type: none"> <li>• Students who have a sense of self-efficacy are more willing to participate, work harder, persist longer when they encounter difficulties, and achieve at a higher level than students who doubt their learning capabilities (Schunk and Zimmerman).</li> <li>• Teachers foster student self-efficacy by recognizing that each student can succeed and by communicating that belief to the student. A student's perception that he or she is a poor learner is a strong predictor of poor performance, overriding natural ability and previous learning (Silver and Marshall). All students benefit from knowing that the teacher believes they can succeed and will provide the necessary supports to ensure that learning takes place.</li> <li>• Teachers also foster a sense of self-efficacy by teaching students that they can learn how to learn. Students who experience difficulty often view the learning process as mysterious and outside their control. They believe that others who succeed in school do so entirely because of natural, superior abilities. It is highly motivating for these students to discover that they, too, can learn and apply the strategies that successful students use when learning.</li> </ul>
<ul style="list-style-type: none"> <li>• Help students to learn about and monitor their own learning processes.</li> </ul>	<ul style="list-style-type: none"> <li>• Research shows that students with high metacognition (students who understand how they learn) learn more efficiently, are more adept at transferring what they know to other situations, and are more autonomous than students who have little awareness of how they learn. Teachers enhance metacognition by embedding, into all aspects of the curriculum, instruction in the importance of planning, monitoring, and self-assessing. Teachers foster a will to learn when they support "the cognitive curriculum with a metacognitive and motivational one" (Turner 199).</li> </ul>
<ul style="list-style-type: none"> <li>• Assign tasks of appropriate difficulty, communicating assessment criteria clearly and ensuring that students have clear instruction, modelling, and practice so they can complete the tasks successfully.</li> </ul>	<ul style="list-style-type: none"> <li>• Systemic instruction helps students to learn strategies they can apply independently (Ellis et al.).</li> </ul>
<ul style="list-style-type: none"> <li>• Help students to set specific and realistic personal goals and to learn from situations where they do not attain their goals. Celebrate student achievements.</li> </ul>	<ul style="list-style-type: none"> <li>• Research shows that learning is enhanced when students set goals that incorporate specific criteria and performance standards (Foster; Locke and Latham).</li> <li>• Teachers promote goal-setting skills by working in collaboration with students in developing assessment strategies and rubrics (see Section 3: Assessment in Grade 12 Chemistry and Appendix 9: Assessment).</li> </ul>

(continued)

---

\* Source: Manitoba Education and Training. *Senior 4 English Language Arts: A Foundation for Implementation*. Winnipeg, MB: Manitoba Education and Training, 2000. Adapted from Section 2, pp. 20-21.



<b>Fostering Motivation (continued)</b>	
<b>Ways to Foster Expectations of Success</b>	<b>Best Practice and Research</b>
<ul style="list-style-type: none"> <li>• Offer choices</li> </ul>	<ul style="list-style-type: none"> <li>• Intrinsic motivation is closely tied to students' self-selection of topics, texts, learning activities, and creative forms. Teachers may involve students in the choice of a topic for thematic development. Support students in the search for learning resources that are developmentally appropriate and of high interest, and encourage students to bring the world views they value into the classroom. Self-selection allows students to build their learning on the foundation of their personal interests and enthusiasm.</li> </ul>
<ul style="list-style-type: none"> <li>• Set worthwhile academic objectives.</li> </ul>	<ul style="list-style-type: none"> <li>• Rather than asking students to execute isolated skills or perform exercises that are without context, embed instruction in meaningful events and activities that simulate real-world settings, and ensure that students share performances and products with a peer audience.</li> </ul>
<ul style="list-style-type: none"> <li>• Help students to learn about and monitor their own learning processes.</li> </ul>	<ul style="list-style-type: none"> <li>• In teaching specific learning strategies, focus on the usefulness of each strategy for making information meaningful, or for expressing ideas of importance to students. Emphasize the importance of science to the richness and effectiveness of students' lives, and de-emphasize external rewards and consequences such as marks.</li> </ul>
<ul style="list-style-type: none"> <li>• Ensure that scientific experiences are interactive.</li> </ul>	<ul style="list-style-type: none"> <li>• A community that encourages students to share their learning with each other values science. Teachers who model curiosity, enthusiasm, and pleasure in learning science-related concepts, and who share their experiences, foster motivation for scientific literacy.</li> </ul>

### **Creating a Stimulating Learning Environment**

A vital science class grows out of, and is reflected in, a stimulating and inviting physical environment. While the resources and physical realities of classrooms vary, a well-equipped science classroom offers or contains a variety of resources that help stimulate learning. It is helpful to involve students in the classroom design.

Ways to create a stimulating learning environment include the following:

- **Flexible seating arrangements:** Use movable desks or tables to design seating arrangements that reflect a student-centred philosophy and that allow students to interact in various configurations.
- **A media-rich environment:** Have a classroom library of books for self-selected reading. The classroom library may include science periodicals, newspaper articles, newsletters, Internet articles, science-fiction literature, and students' published work. It may also include a binder of student reviews and recommendations, and may be decorated by student-designed posters or book jackets. Classroom reference materials could include dictionaries/encyclopedias of science, books of facts, software and CD-ROM titles, past examinations collated into binders, and manuals.
- **Access to electronic equipment:** Provide access to a computer, television, videocassette recorder, DVD-ROM, and video camera, if possible.

- **Wall displays:** Exhibit posters, Hall of Fame displays, murals, banners, and collages that celebrate student accomplishments. Change these regularly to reflect student interests and active involvement in the science classroom.
- **Display items and artifacts:** Have models, plants, photographs, art reproductions, maps, newspaper and magazine clippings, fossils, musical instruments, and so on, in your classroom to stimulate inquiry and to express the link between the science classroom and the larger world.
- **Communication:** Post checklists, processes, and strategies to facilitate and encourage students' independent learning. Provide a bulletin board for administrative announcements and schedules.
- **Well-equipped and safe laboratory:** Provide regular access to a well-equipped and safe science lab to foster the development of critical lab skills.

### Language Learning Connected to Science

Science curricula involve all aspects of language and literacy development. Halliday suggests that as students actively use the language arts, they engage in three kinds of language learning, which can be linked to broader scientific literacy (cited in Strickland and Strickland 203).

- **Students learn language:** Language learning is a social process that begins at infancy and continues throughout life. Language-rich environments enhance and accelerate the process. Terminology-rich science has a role in new language development.
- **Students learn through language:** As students listen, read, or view, they focus primarily on making meaning from the text at hand. Students use language to increase their knowledge of the world.
- **Students learn about language:** Knowledge of language and how it works is a subject in and of itself; nevertheless, science as a discipline of inquiry relies on a particular use of language for effective communication. Consequently, students also focus on the language arts and their role when applied to science.

Scientific literacy learning is dynamic and involves many processes. The following graphic identifies some of the dynamic processes that form the foundation for effective literacy learning in science classrooms.

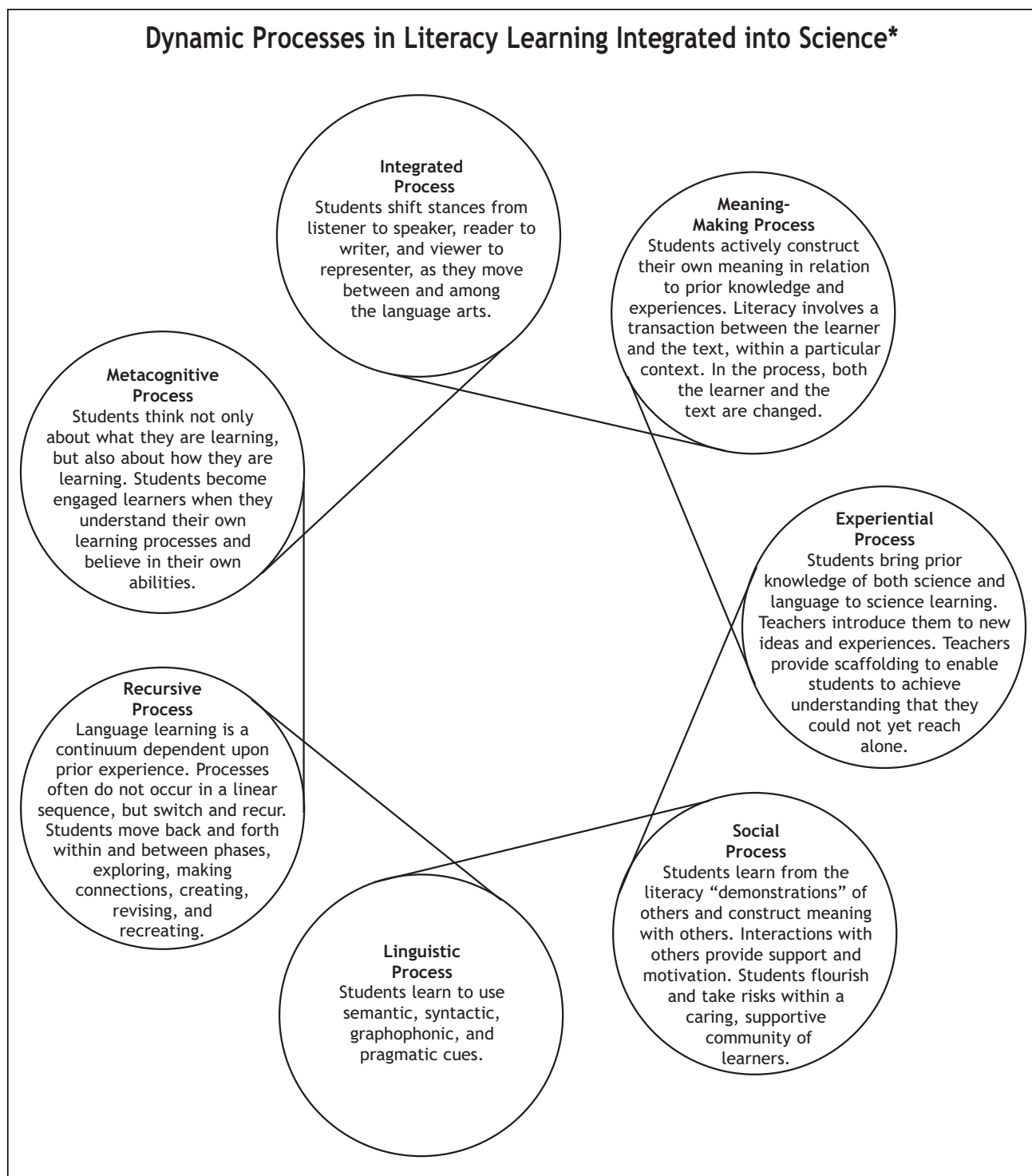

\* Source: Manitoba Education and Training. *Senior 2 English Language Arts: A Foundation for Implementation*. Winnipeg, MB: Manitoba Education and Training, 1998. Adapted from Overview, p. 11.

### **Ethical Issues**

The development of topics within Grade 12 Chemistry should lead to issues and questions that go beyond the traditional curriculum. For example, medical biochemistry, or the implementation of international protocols related to the prospects of global climate change, raises questions of ethics, values, and responsible use of the products of the physical sciences. The environmental consequences of the industrial applications of chemistry, or the atmospheric chemistry of climate change, raise issues of considerable importance, as do the topics of nuclear waste disposal and weapons procurement. These are among the important issues that science is often called upon for advice. As students and teachers address these issues, they will naturally be drawn to the study of the underlying scientific concepts. Students should realize that science only provides the background for making informed personal and social decisions, and that, as informed decision makers, they may have an impact on society and the world. Students of chemistry are not immune to the importance of these aspects of science in a modern, post-industrial world.

Some students and parent(s) may express concern because the perspectives of current science conflict with personal systems of belief. These individuals have a right to expect that science and the public education system will respect those beliefs, although this does not preclude such issues from arising in the classroom. Teachers should explain to students that science is one way of learning about the universe and our unique place embedded in it, and that other explanations, in addition to those of the traditional Western sciences, have been put forth—particularly in the realm of cosmogony.

### **Diversity in the Classroom**

Students come from a variety of backgrounds and have distinct learning requirements, learning and thinking approaches, and prior knowledge and experiences. Their depth of prior knowledge varies, reflecting their experiences inside and outside the classroom. Some entry-level knowledge held by students may be limited or incorrect, impeding new learning. For new learning to occur, it is important for teachers to activate students' prior knowledge, to correct misconceptions, and to encourage students to relate new information to prior experiences.

Manitoba's cultural diversity provides opportunities for embracing a wealth of culturally significant references and learning resources in the Senior Years science classroom. Students from various backgrounds bring socially constructed meanings, references, and values to science learning experiences, as well as their unique learning approaches. As noted in *Senior Years Science Teachers' Handbook*, "To be effective, the classroom must reflect, accommodate, and embrace the cultural diversity of its students" (Manitoba Education and Training 7.13).

In addition, cultural influences can affect how students think about science: reasoning by analogy or by strict linear logic; memorization of specific correct responses or generalizations; problem solving by induction or by deduction; or needing to learn through hands-on apprenticeship to gain one aspect of a skill before moving on to the next step (Kolodny). Cultural prohibitions permeate some societies; for example, values that discourage assertiveness, outspokenness, and competitiveness in some cultures can result in behaviour that can be interpreted as being indifferent, having nothing to say, or being unable to act decisively (Hoy; National Research Council). The problems engendered by these cultural differences are often beyond the ability of teachers of advanced courses to handle on their own. In many such cases, support from other members of the school staff is essential.

### **Learning Resources**

Traditionally, the teaching of science in Senior Years has largely been a textbook-centred enterprise. The use of a single textbook as the sole resource for the teaching and learning of science severely restricts the development of knowledge, skills and strategies, and attitudes that are critical for today's students. Furthermore, it promotes the idea that all answers are enshrined in a textbook. The successful implementation of Grade 12 Chemistry depends on a resource-based learning approach, in which textbooks are used only as one of many reference sources. Research suggests that we should provide a wide range of learning resources for structuring teaching and learning experiences. These include human resources, textbooks, magazines/journals, films, audio and video recordings, computer-based multimedia resources, the Internet, and other materials.

Resources referenced in this curriculum include print reference materials such as *Senior Years Science Teachers' Handbook: A Teaching Resource* (Manitoba Education and Training) and *Science Safety: A Kindergarten to Senior 4 Resource Manual for Teachers, Schools, and School Divisions* (Manitoba Education and Training). In addition, numerous articles from the chemistry education research community are recommended to teachers.

The choice of learning resources, such as text(s), multimedia learning resources (including video, software, CD-ROMs, microcomputer-based laboratory [MBL] probeware, calculator-based laboratory [CBL] probeware), and websites, will depend on the topic, the local situation, the reading level of students, the background of the teacher, community resources, and availability of other materials. A concerted effort should be made to use appropriate learning resources from a wide variety of sources, as not all curricular outcomes can be achieved by using any one resource in the study of a particular topic.

---

### ***Selecting Learning Resources***

For information on selecting learning resources for Grade 11 and Grade 12 Chemistry, see the Manitoba Education website at [www.edu.gov.mb.ca/k12/learnres/bibliographies.html](http://www.edu.gov.mb.ca/k12/learnres/bibliographies.html).

---

## Implementing the Curriculum

Chemistry curricula in the past have focused primarily on presenting a breadth of knowledge (that is, a large amount of content) deemed essential, and on the mathematical manipulation of algorithms. While the Grade 12 Chemistry curriculum continues to be concerned with students gaining relevant knowledge and with providing appropriate mathematical treatment of concepts, it is also concerned both with fostering the development of various skills (context-based process skills, decision-making skills, problem-solving skills, laboratory experimental skills, critical thinking skills, independent learning skills) and with effecting a change of viewpoint. A strong focus of Grade 12 Chemistry is to link science to the experiential life of students.

By offering a multidisciplinary focus where appropriate, Grade 12 Chemistry provides a new set of foundations for fostering increased scientific literacy. Consisting of 28 general learning outcomes (GLOs), each linked with a number of specific learning outcomes (SLOs), the Grade 12 Chemistry curriculum will build upon what students know and are able to do as a result of their studies in Kindergarten to Grade 10 Science (see Kindergarten to Grade 10 Science and Grades 11 and 12 Chemistry Topic Chart at the end of Section 1: Manitoba Foundations for Scientific Literacy). As many foundational concepts are taught in Grade 11 Chemistry, students are strongly encouraged to have completed Grade 11 Chemistry before they begin Grade 12 Chemistry.

Grade 12 Chemistry assumes *110 hours* of instructional time, and is designed to include formal assessments, field excursions, and related co-curricular efforts.

## Effective Teaching in Chemistry: What the Research Says to Teachers

### Findings of Research on How Students Learn

A number of summaries of the instructional implications of recent research on learning are provided below. The National Research Council report *How People Learn: Brain, Mind, Experience, and School* (Bransford, Brown, and Cocking) can be adapted and elaborated specifically for the study of chemistry. That report leads to the following implications for effective chemistry instruction.

- 1. Effective teachers draw out and work with students' current understandings, including those understandings students bring with them to the course and those they develop as the course progresses.**

There is an emerging consensus in science education research, including a substantial body of work specific to introductory chemistry, that, to be effective, instruction must elicit, engage, and respond substantively to student understandings (Champagne, Gunstone, and Klopfer; Clement; Hake; Hestenes, Wells, and Swackhamer; McDermott and Redish). There are now a number of examples of curricula and materials designed to support interaction with students' prior understandings, and there is evidence that these approaches can achieve progress in understanding that is not possible for most students with traditional methods.

**2. Effective teachers address students' metacognitive skills, habits, and epistemologies.**

Students need to understand not only the concepts of chemistry, but also the nature of knowledge and learning (Hammer; Hewson; McDermott; Reif and Larkin; White and Frederiksen). Many students arrive at chemistry courses, including advanced-treatment courses such as Chemistry Advanced Placement (AP), expecting to learn by memorizing formulas disconnected from each other, as well as from the students' experiences of the physical world. Effective instruction challenges these expectations, helping students to see chemistry learning as a matter of identifying, applying, and refining their current understanding. Students learn to examine assumptions hidden in their reasoning; to monitor the quality and consistency of their understanding; to formulate, implement, critique, and refine models of physical phenomena; and to make use of a spectrum of appropriate representational tools. By the end of a chemistry course, students develop a rich sense of the coherent, principled structure of chemistry and are both able and inclined to apply those principles in unfamiliar situations. In short, effective instruction should work toward the objectives identified in Section 1: Manitoba Foundations for Scientific Literacy.

**3. Effective teachers are sophisticated diagnosticians of student knowledge, reasoning, and participation.**

How teachers respond to student thinking depends critically on what they perceive in that thinking, on what they interpret to be the strengths and weaknesses of the students' understanding and approach. Effective teachers continually gather information to support this ongoing assessment from several different sources: written work on assignments, tests, and quizzes; classroom discussions; and contact with students outside the classroom. They ask students to explain their reasoning throughout their work, particularly through the appropriate and measured use of differentiated instruction techniques. Upon gaining new insights into student understanding, effective teachers adapt their instructional strategies and assessments.

**4. Effective teachers teach a smaller number of topics in greater depth, providing many examples in which the same concept is at work.**

This is a common refrain in findings from education research, often expressed in the slogan "less is more." In part, this finding is an implication of the previous two: drawing out and working with student understandings and addressing metacognitive skills and habits all take time, and this necessitates a reduction in the breadth of coverage. Education research also suggests that coming to understand a concept requires multiple encounters in a variety of contexts. This finding is reflected across this chemistry curriculum, drawing on the "spiralling" approach that revisits prior knowledge in new ways, or at an increased level of sophistication.

### **Making Interdisciplinary Connections in the Chemistry Classroom**

An important issue for a field as ancient as chemistry is how it adapts to the needs of society in a given place and time. The field of chemistry today faces a period of transition.

- A period in which technology and knowledge-based industries are the primary drivers of the national economy has begun.
- A period in which other areas of science, such as microbiology and genetics, will undergo rapid progress has also begun.
- The increasing availability, power, and sophistication of computational hardware and software will make possible novel quantitative descriptions of the physical universe. Society in general appears to be rapidly becoming more and more knowledge based. Enormous quantities of information are instantly available on ubiquitous computers.

Teachers of chemistry will need to be able to apply the body of knowledge developed within chemistry to totally new areas. In other words, chemistry teachers will be asked to become more interdisciplinary; they will have to apply their special knowledge and methods to problems that cross the boundaries of traditional disciplines.

On the other hand, the topics that possess several features that naturally allow students to begin to confront interdisciplinary issues are welcome, and align more closely to the new emphases outlined in Section 1: Manitoba Foundations for Scientific Literacy. First, there is the provision for interdisciplinary options (such as biomedical chemistry, historical chemistry, the nature of science as seen through chemistry) that teachers may choose to create.

Collaborative group work of students creates its interdisciplinary dimension through ownership of a collaborative scientific investigation. Such projects can easily involve applying knowledge and methods from several different scientific fields. Increased interdisciplinary content could be added to chemistry courses by developing more contexts such as the biomedical chemistry option mentioned above. Alternatively, the enriched chemistry course might choose to explore examples illustrating how fundamental physical principles apply to a wide variety of areas. For example, the elastic properties of DNA molecules might be used to discuss the range of validity of Hooke's law for spring forces. Biological cell membranes could be used to construct interesting examples of electrical potential differences and electric fields. In agreement with the National Research Council's *National Science Education Standards* (NSES), Manitoba Education encourages teachers to include some experiences with the interdisciplinary applications of chemistry when implementing the chemistry curriculum.



## Unit Development in Chemistry

Grade 12 Chemistry is driven by specific learning outcomes that can be arranged in a variety of groupings. This design empowers teachers to plan appropriate learning experiences based on the nature of their students, school, and community. Teachers are encouraged to seek their own instructional design with the new curriculum, to share approaches and experiences with colleagues, and to use an integrated interdisciplinary focus to develop and extend student experiences and understandings in new ways.

Working with bigger ideas can allow for a more in-depth inquiry. Organizing around a problem or theme will generally present information in the context of real-world applications (Willis). For instance, the treatment of vector analysis or free-body diagrams—usually taught in isolation as discrete mastery skills—could be better served by presenting these concepts at the time when the context will demand their use. Throughout the year, provide students with opportunities to uncover concepts from among the sciences in a substantial way, and to make coherent connections among them to chemistry.

Science deals with major themes in which people are already interested or can readily be interested: life and living things, matter, the universe, information, the “made-world.” A primary reason, therefore, for teaching science to young people is to pass on to them some of this knowledge about the material world, simply because it is both interesting and important—and to convey the sense of excitement that scientific knowledge brings (Millar and Osborne 7).

For teachers adopting a “thematic” or “big ideas from chemistry” approach to organizing the course, choosing an effective theme is critical to the success of such a pathway. Involving students in the selection of a theme (or the important subcomponents of a compulsory topic) will encourage and motivate them by recognizing their interests.

A theme should

- be broad enough for students to find personal areas of interest
- promote learning
- have substance and apply to the real world
- have relevant materials readily available
- be meaningful and age-appropriate
- have depth
- integrate across the disciplines of chemistry, biology, physics, and geosciences
- fascinate students (Willis)

## A View of Chemistry Education: Toward Modes of Representation

Ask your students to respond, in one sentence, to the question, “what is chemistry?” Responses tend to describe previous experiences with chemistry content: “chemistry is molecular motion,” or “chemistry is the study of energy and matter,” or “chemistry is like physics with lots of math in it,” or, from an educator’s standpoint, “chemistry is an understanding of particulate representations not visible to us.” Other responses are more global: “chemistry is the study of the makeup of the universe,” or “chemistry is the science of all things.” The relationship of mathematics to chemistry is predominant; a common lament is “chemistry is math” or “chemistry is figuring out the simple things in everyday life in a mathematically complex way” at the Senior Years. These responses indicate that students see mathematics as *the* process of chemistry. Many see chemistry as an important aspect of their preparation for an uncertain future, but with a varying sense of what chemistry really is and what it could do for them.

What is chemistry? Although answers vary, a common theme exists if we consider the various branches of chemistry and the underlying principles. Chemistry can also be considered as including *particulate representations* in the world we perceive around us. However, those relationships are embedded in visual, social, and historical contexts – a set of lenses through which the relationships are perceived and acted upon. For instance, we contemplate “something interesting,” and then build models to identify fundamental characteristics to determine how they interact and influence each other. From these relationships we are able to predict the behaviour of other “interesting things” that have the same or similar parameters. A major component of chemistry, then, is the study of relationships in a variety of different forms. What makes the study of chemistry so difficult for so many is that relationships can be represented in many different ways – and too often are shown in just one manifestation, the mathematical symbolic relationship.

### The Modes of Representation

The modes of representing relationships include the following:

- macroscopic (visual) mode
- numerical mode
- graphical mode
- symbolic mode
- particulate mode

To facilitate teaching and learning, it is important to understand the various modes of representation and their relationship to each other.

### Macroscopic (Visual) Mode

To illustrate the modes of representation, consider an example making use of the physical properties of gases under changes in pressure. Initially, a single book is placed on top of syringe apparatus (see illustration below). If we then enlarge the scope of the picture by adding other books, we can perceive that a relationship is emerging relating the amount of mass added to the syringe (that is, compressing the gas within the syringe) and the amount of compression in the gas sample. This is what we would call the *macroscopic (visual)* mode of representing a relationship. Its basis is in the “real” world of sense perception and our associated perceptions of how this “world” operates.

In the macroscopic (visual) mode, we suggest a relationship between two variables and then test our hypothesis by observation and experimentation. In the present case, as the downward force increases with the addition of more books, the syringe depresses in some easily observed proportional manner. Sometimes we can even determine the exact relationship. In this case, we can place a hypothetical “straight edge” to line up in a straight line across the syringes, and certainly this does seem to indicate that there is a predictable relationship.

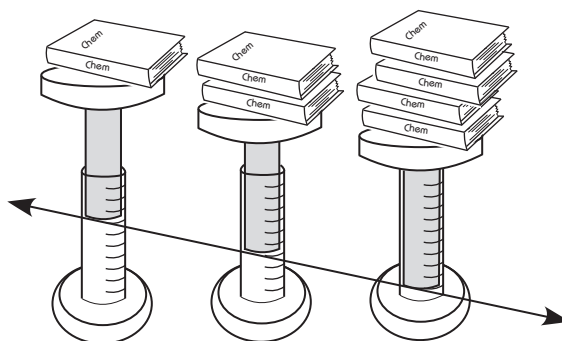

The macroscopic (visual) mode of representation embodies more than conjecture and observation. It incorporates critical and creative thinking as we build and modify models of nature that act as a foundation for our investigations. The “real” world is conceptualized by a set of guiding assumptions we imagine to be true. We may internalize a model to aid this conceptualization, and then we test this model using experiments. A successful model has explanatory and predictive capabilities. A model may incur discrepant events, which may force us to reconsider and modify our model. Our model may be falsified, in which case we abandon the model in search of a more complete and accurate model. For instance, the model of electric charge provides a foundation for the examination of electric phenomena. Historically, the fluid and particle models of charge accounted for experimental observations. However, as our ideas about the structure of matter evolved, the particle model provided a more reliable, predictive, and robust explanatory model.

Although we can make some general descriptions of relationships (e.g., as pressure increases, volume decreases), we cannot always determine an exact relationship using the macroscopic (visual) mode of representation. Therefore, we *quantify* the characteristics and compare the numbers. This is called the *numerical* mode of representation.

### Numerical Mode

In the *numerical* mode of representation, we *operationally define* fundamental properties and use measurement to collect data. In the case here, the pressure exerted on the gas is operationally defined as “changes in the position of the syringe” and is something we can readily see with the eyes. If there is no pressure applied, we see no change in the position of the syringe, and greater force implies greater pressure exerted on the air within the syringe. We can then examine the data to determine an exact relationship. The numerical mode dictates an understanding of proportioning and numerical patterns (e.g., if pressure [P] doubles, volume [V] is halved, and if P triples, V is reduced to a third of the original volume, and so on). This suggests a direct proportion, and we can then formulate a representative “law” describing the predictable behaviour of confined gas samples or other phenomena of interest. However, in most cases that students and researchers are involved in, the collection of data results in systematic errors. Determining the relationship by simple inspection of the data can be very difficult. A picture, however, is worth a thousand numbers to us. Graphing the data usually gives a clearer picture of the relationship. It could be looked upon, for students, as a preparation for examining closely a “picture of the numbers” (the graph).

The following data table is an example of a numerical mode that is of importance to us at Grade 12 – to identify a *direct relationship* if that is the case, or an *inverse relationship* such as in the example here (volume and pressure in a gas sample):

Volume and Pressure in a Gas	
Volume (mL)	Pressure (mmHg)
30.5	739.8
20.3	1122.4
15.2	1493.8
10.2	2232.0

## Graphical Mode

The *graphical* mode of representation is a mathematical picture of the relationship. Fortunately, there are a limited number of pictures one needs to know to determine relationships. In fact, at the introductory Grade 12 Chemistry level, it is only necessary to know three pictures that derive from mathematical relationships: a straight line, a power curve, and an inverse curve. By adjusting the data to “straighten the curve,” we can determine the exact relationship and formulate a law that can be represented in a symbolic manner.

For our purposes here, there can be no better example of the power of mathematical modelling than that from the relationship between the volume of a gas sample and the pressure it exerts on the walls of a container. We, of course, know this as Boyle’s Law, but it is instructive to view this from the point of view of students and our discussion here of modes of representation. Below is a graphical representation of numerical data from a fictitious student lab experience based on Robert Boyle’s original data:

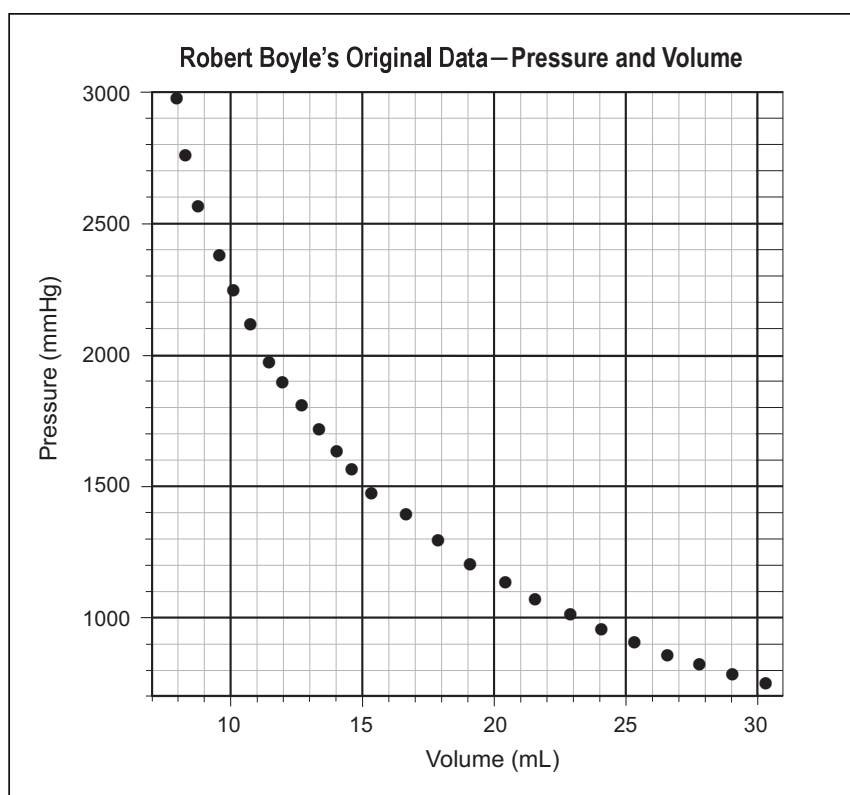

We would expect two things to arise from a discussion of this “picture.” First, the relationship is inverse in some way (as one variable gets larger, the responding variable gets smaller). Second, the inverse behaviour is not “one to one”; that is, it is not a linear relationship. We cannot expect that either volume or pressure can increase or decrease indefinitely in realistic terms. In order to “tease out” or model the physical law that explains this behaviour of gases under pressure, students are instructed in the techniques for *curve straightening* at Grade 12. This technique directly links the *graphical* and *symbolic* modes of representation.

Let's see how this is accomplished. Our initial mathematical model states, using the present example with gases, that some sort of inverse relationship exists between volume and pressure. Expressing this as follows is a good starting point:

Pressure goes down as volume goes up.

$$P \propto \frac{1}{V}$$

or

$$P = k \cdot V^{-1}$$

The implication is that if we replot that data, but this time plot the *inverse of volume* against pressure, a new relationship should become visible:

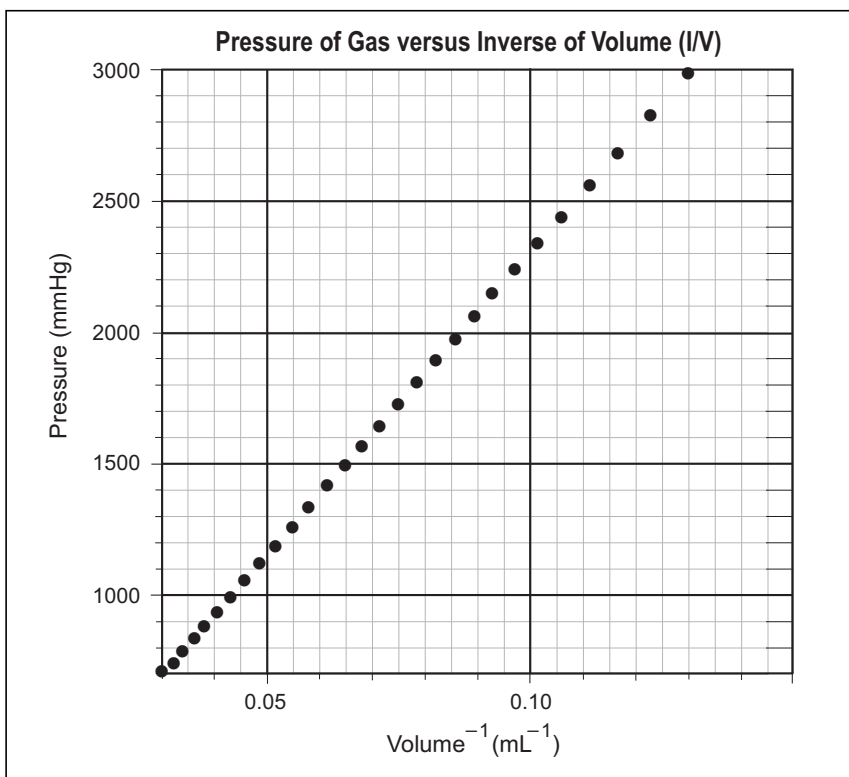

### Symbolic Mode

The fourth mode of representation is the *symbolic* mode. To continue with our example using Boyle's Law, we represent the relationship between the pressure and volume of a gas as an *algebraic* relationship, which can be applied to other physical events that are similar in nature. When we look again at the last graph plotting the inverse of volume with pressure, it is clearly evident that a direct relationship exists between these two quantities. It would be very easy to determine a line of "best fit" for this graph, determine the slope of that line, and close off the discussion with the statement of a fundamental physical law.

If  $P = k \cdot V^{-1}$ , then  $P \cdot V = \text{a constant } (k)$ .

We then can state Boyle's Law as the product of pressure and volume as being a constant....

Thus far, we have represented relationships in four different modes: macroscopic (visual), numerical, graphical, and symbolic. In our model of chemistry education, students should be afforded the opportunity to function in each mode of representation to demonstrate growing understanding and mastery of these modes conceptually.

### Particulate Mode

Now, we will discuss a fifth mode of representation: *particulate* representations. Throughout Grade 12 Chemistry, students will regularly involve themselves with modelling chemical phenomena. This will include building ball-and-stick models, using software simulations, or drawing pictures of events that are occurring at the nanometre scale and are beyond our spatial constraints. For instance, we could illustrate the gas sample featured in this discussion in this manner:

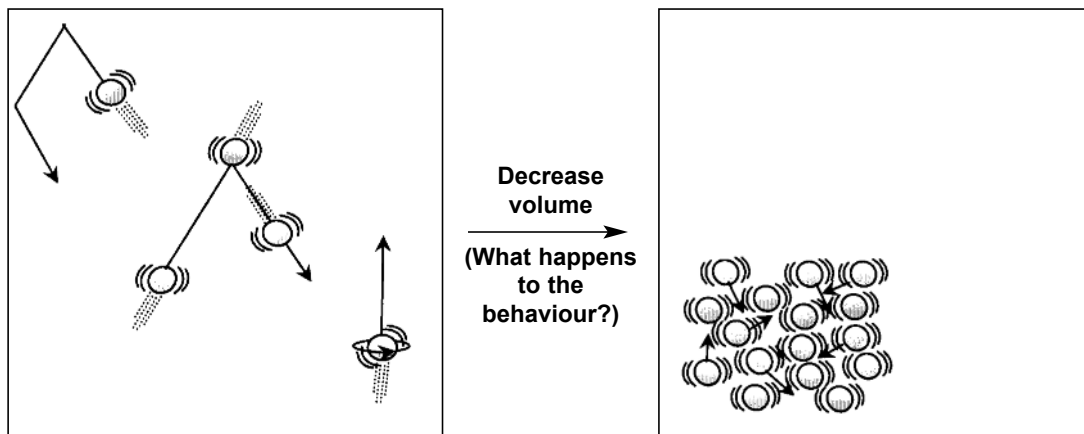

### **The Importance of the Modes of Representation**

It is easy to become caught up in a single mode of representation, especially the symbolic mode, when teaching and learning chemistry. Students often complain about the number of calculations in their chemistry course, or question their purpose. They dutifully memorize equations and notation, learn to substitute for variables, and arrive at numerical solutions. Students and teachers can easily become trapped exclusively within the symbolic mode of representation. Instruction using the symbolic mode is easy because little or no preparation is required. The teacher, already grounded in mathematical principles, only needs to derive an equation algebraically. This “out of context” treatment of relationships between the physical/conceptual (i.e., visual mode variables) and the symbolic presents tremendous difficulties for most students, including those students who are apparently mathematically competent.

Meaningful connections between the symbolic and physical/conceptual modes are difficult to make in a decontextualized setting. Many teachers, whose own instruction in chemistry may have been primarily in the symbolic mode, may never have mediated their own conceptual difficulties. Students taught exclusively in the symbolic mode often know how to arrive at “cookbook” answers, but they rarely understand the chemistry or retain the concepts. In fact, their difficulties rarely focus on chemistry. Confusion appears because of notation, similar types of equations, various algebraic representations of formulas, and calculations. As soon as physical concepts are necessary, as in word problems beyond the “plug and slug” variety, success rates decrease dramatically. Research in chemistry education indicates that many advanced students experience difficulties when operating in the physical/conceptual domain, but do calculations with apparent ease and success. This, of course, may not be surprising if students’ instruction has been almost exclusively in the symbolic mode of representation.

Students need to develop their understanding of relationships more completely, and develop skills in each mode of representation. Students should be able to transfer between modes both fluidly and with facility. Moving through the modes is not necessarily done in consecutive order. A “real scientist” can begin investigations in any mode and transfer easily through any combination of modes. Students who demonstrate a complete understanding of physical/conceptual relationships should be able to move from mode to mode in any order.

While fluency with the modes of representation provides a solid foundation for chemistry education, it is, of itself, not complete when portraying the nature of scientific activity. Albert Einstein, while developing his theory of relativity, conceptualized a hypothesis and then deduced a series of laws symbolically from a set of fundamental assumptions about time and space. He left it to others to observe, and then refute or confirm his propositions. Historical perspectives, and an understanding of the nature of science, will move students toward a more philosophically valid treatment of chemistry.



### Summing up the Modes of Representation for Chemistry Teachers

**Macroscopic (Visual):** Encourage students to discuss the representations they see and experience.

**Numerical:** Use student-generated measurements—always in the context of activities.

**Graphical:** Carefully plot graphs; get the “picture of the numbers,” not “this is a picture of the world.”

**Symbolic:** Emphasize the concept first, and then initially apply formulas as word definitions. Only then work “type” problems using formulas. Ideally, formulas are memorized only in certain instances.

**Particulate:** Frequently make use of physical models that explain or illustrate the invisible world of molecular structure and behaviour. Attempt to connect physical phenomena with the underlying microscale movements of *particles*.

### Toward an Instructional Philosophy in Chemistry

Teaching Grade 12 Chemistry with a focus on both content and processes naturally allows for the use of a variety of instructional strategies. These strategies include the collection and analysis of data from both laboratory work and field work, group and individual instruction, a diversity of questioning techniques, decision-making, problem-solving, and design-process activities, and a resource-based approach to learning. Senior Years science programming should foster critical thinking skills and promote the integration of knowledge and the application of facts to real-life situations. Scientific concepts from other Senior Years science courses may become part of the subject matter as the Grade 12 Chemistry course develops in the classroom. This approach is a valuable and useful means of reinforcing and validating scientific concepts as having relevant and contextual applications.

Chemistry is, in part, a way of thinking that has rules for judging the validity of answers applicable to everyday life. It is an intense human activity, full of trial and error that is influenced by cultural priorities and humanistic perspectives. The myth of total objectivity that often permeates scientific dialogue also needs to be exposed and discussed. Among the natural sciences, “scientific truth” is no longer viewed as an objective reality awaiting discovery; rather, it is placed in the context of something always to be sought. In recognition of the tentative nature of current knowledge claims, “scientific truth” is not a goal that can be reached in absolute terms, but can remain as one of the hallmarks of the traditions of scientific practice.

Students should be encouraged to make distinctions between what is observable and testable, as well as develop the ability to consider the abstract deductions, models, and themes that derive from evolving scientific research and thinking.

Conceptual knowledge in science can also be integrated with principles from other disciplines. The inclusion of social, historical, and political implications in the study of chemistry provides students with opportunities to develop a facility to communicate ideas effectively through verbal and written expression. Finally, students will benefit from opportunities to develop an awareness of the options available to them for careers and vocations in the wide diversity of sciences.

Grade 12 Chemistry, as a component of young people's whole educational experience, will assist in preparing them for a full and satisfying life. This curriculum will sustain and develop the curiosity of young people about the natural world around them, and build their confidence in their ability to inquire into its behaviour, now and in the future. It seeks to foster a sense of wonder, enthusiasm, and interest in science so that young people will feel confident and competent to engage with everyday scientific and technological applications and solutions.

As students study a range of topics through various sub-disciplines of chemistry, they will develop a broad, general understanding of the important ideas and explanatory frameworks of the field as a whole, including the procedures of scientific inquiry that have had a major impact on our material environment and on our culture. They will develop an appreciation for why these ideas are valued and the underlying rationale for decisions that they may wish, or may be advised, to take in everyday contexts, both now and in later life. They will be able to understand, and respond critically to, media reports of issues with a science (particularly a chemistry-related) component. Finally, students will feel empowered to hold and express personal viewpoints on issues with a science component that enter the arena of public debate, and perhaps to become actively involved in some of these issues (Millar and Osborne 12).

### Results-Based Learning\*

In results-based learning, the programming focus is on what students know and can do, rather than on what material is "covered." The learning outcomes are an elaboration of the knowledge, strategies, and skills and attitudes expected of each Grade 12 Chemistry student. All programming decisions are directed toward addressing the gap between the students' present level of performance and the performance specified in the learning outcomes.

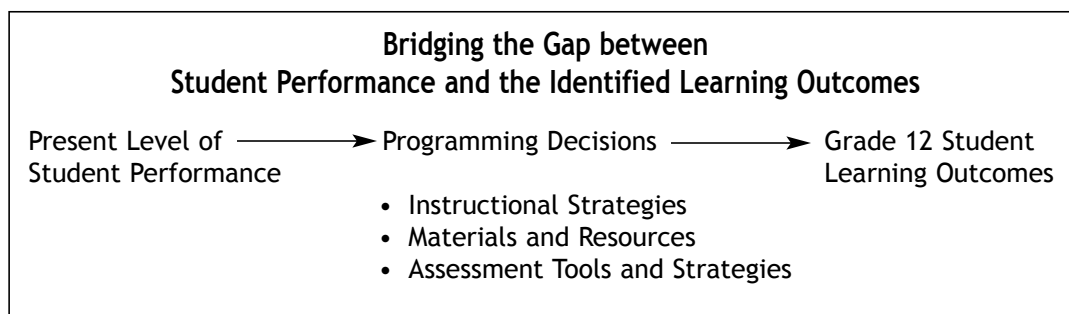

---

\* Source: Manitoba Education and Training. *Senior 4 English Language Arts: A Foundation for Implementation*. Winnipeg, MB: Manitoba Education and Training, 2000. Adapted from Section 2, p. 9.

The student learning outcomes are not taught separately or in isolation. Nor are they taught consecutively in the order in which they appear in the curriculum documents. Most lessons or units draw on knowledge, skills and strategies, and attitudes addressed in several or all general learning outcomes. In the process of planning, teachers are encouraged to identify the learning outcomes they intend to assess, and link all assessment to the specific learning outcomes.

In implementing results-based curricula, experienced teachers may find that they use many of the instructional strategies and resources they have used previously. However, the nature of results-based learning will reshape their programming in several ways:

- Planning is ongoing throughout the semester or year because instruction is informed by learning requirements that become evident through continuous assessment.
- Some learning outcomes, especially skills and attitudes outcomes, are addressed repeatedly in different ways throughout the school semester or year. As students develop new scientific knowledge, skills and strategies, and attitudes, they need to practise and refine those they have previously experienced.

### **Varied Instructional Approaches\***

Teachers wear a number of different “pedagogical hats,” and change their teaching styles in relation to the cognitive gains, attitudes, and skills demanded of the task at hand (Hodson). In planning instruction for Grade 12 Chemistry, teachers may draw upon a repertoire of instructional approaches and methods and use combinations of these in each unit and lesson. Many suggestions are contained in this document.

Instructional approaches may be categorized as

- direct instruction
- indirect instruction
- experiential learning
- independent study
- interactive instruction

Most teachers draw from all these categories to ensure variety in their classroom learning experiences, to engage students with various intelligences and a range of learning approaches, and to achieve instructional goals.

---

\* Source: Manitoba Education and Training. *Senior 4 English Language Arts: A Foundation for Implementation*. Winnipeg, MB: Manitoba Education and Training, 2000. Adapted from Section 2, p. 10.

The following diagram displays instructional approaches and suggests some examples of methods within each approach. Note that the approaches overlap.

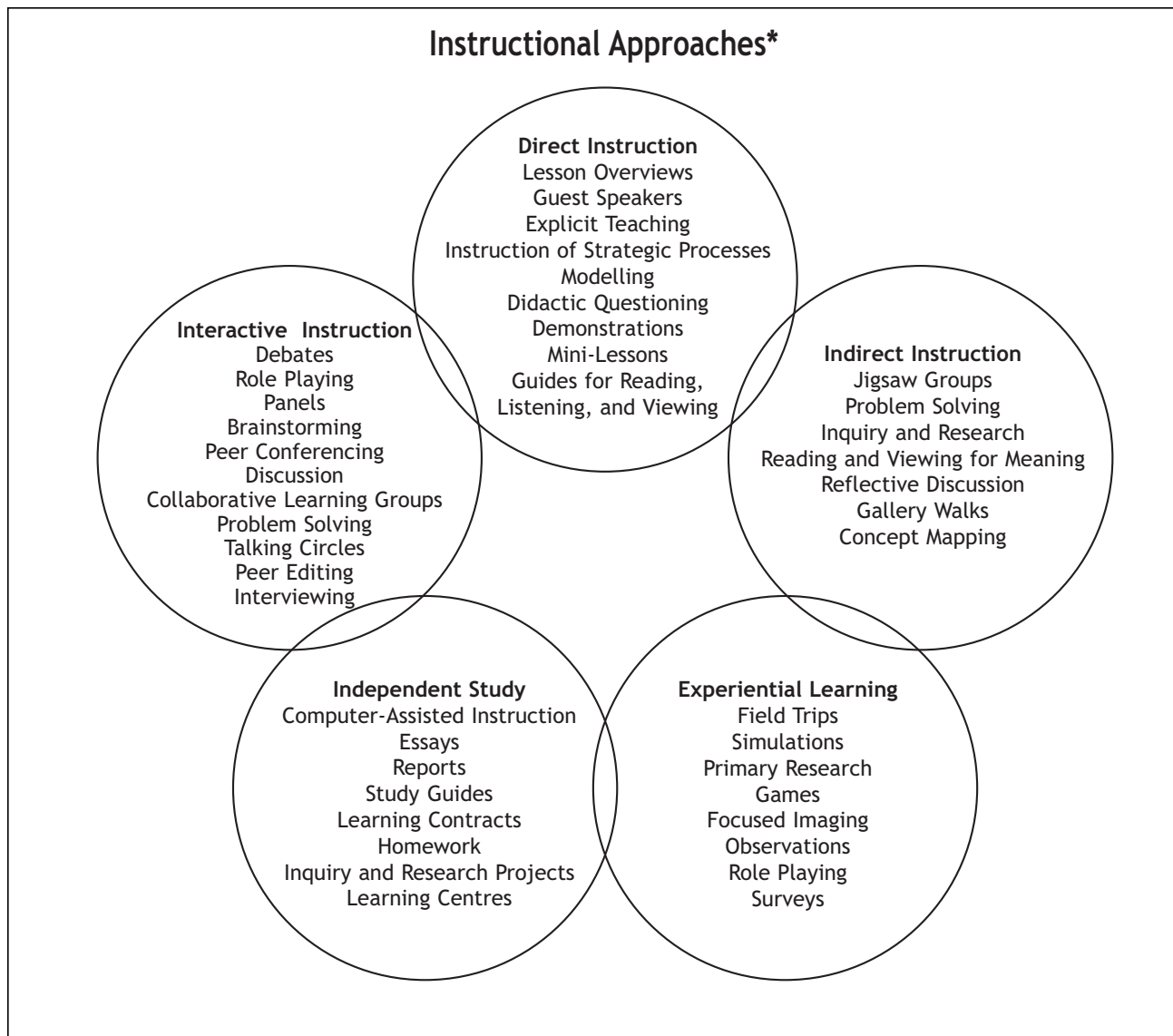

\* Source: © 1991, Government of Saskatchewan. Adapted with permission.

## Instructional Approaches

In selecting instructional approaches and methods, teachers consider which combination will assist students in achieving the learning outcomes targeted for a particular lesson or unit. Teachers consider the advantages and limitations of the approaches and methods, as well as the interests, knowledge, skills, and attitudes of their students. Some of these elements are represented in the following chart.

<b>Instructional Approaches: Roles, Purposes, and Methods*</b>				
<b>Instructional Approaches</b>	<b>Roles</b>	<b>Purposes/Uses</b>	<b>Methods</b>	<b>Advantages/Limitations</b>
<b>Direct Instruction</b>	<ul style="list-style-type: none"> <li>• Highly teacher-directed</li> <li>• Teacher uses didactic questioning to elicit student involvement</li> </ul>	<ul style="list-style-type: none"> <li>• Providing information</li> <li>• Developing step-by-step skills and strategies</li> <li>• Introducing other approaches and methods</li> <li>• Teaching active listening and note making</li> </ul>	Teachers: <ul style="list-style-type: none"> <li>• Explicit teaching</li> <li>• Lesson overviews</li> <li>• Guest speakers</li> <li>• Instruction of strategic processes</li> <li>• Lecturing</li> <li>• Didactic questioning</li> <li>• Demonstrating and modelling prior to guided practice</li> <li>• Mini-lessons</li> <li>• Guides for reading, listening, and viewing</li> </ul>	<ul style="list-style-type: none"> <li>• Effective in providing students with knowledge of steps of highly sequenced skills and strategies</li> <li>• Limited use in developing abilities, processes, and attitudes for critical thinking and interpersonal learning</li> <li>• May encourage passive, not active learning</li> </ul>
<b>Indirect Instruction</b>	<ul style="list-style-type: none"> <li>• Mainly student-centred</li> <li>• Teacher's role shifts to facilitator, supporter, resource person</li> <li>• Teacher monitors progress to determine when intervention or another approach is required</li> </ul>	<ul style="list-style-type: none"> <li>• Activating student interest and curiosity</li> <li>• Developing creativity and interpersonal skills and strategies</li> <li>• Exploring diverse possibilities</li> <li>• Forming hypotheses and developing concepts</li> <li>• Solving problems</li> <li>• Drawing inferences</li> </ul>	Students: <ul style="list-style-type: none"> <li>• Observing</li> <li>• Investigating</li> <li>• Inquiring and researching</li> <li>• Jigsaw groups</li> <li>• Problem solving</li> <li>• Reading and viewing for meaning</li> <li>• Reflective discussion</li> <li>• Concept mapping</li> </ul>	<ul style="list-style-type: none"> <li>• Active involvement an effective way for students to learn</li> <li>• High degree of differentiation and pursuit of individual interests possible</li> <li>• Excellent facilitation and organizational skills required of teachers</li> <li>• Some difficulty integrating focused instruction and concepts of content</li> </ul>

(continued)

\* Source: Manitoba Education and Training. *Senior 4 English Language Arts: A Foundation for Implementation*. Winnipeg, MB: Manitoba Education and Training, 2000. Adapted from Section 2, pp. 11-12.

Instructional Approaches: Roles, Purposes, and Methods (continued)				
Instructional Approaches	Roles	Purposes/Uses	Methods	Advantages/Limitations
<b>Interactive Instruction</b>	<ul style="list-style-type: none"> <li>• Student-centred</li> <li>• Teacher forms groups, teaches and guides small-group skills and strategies</li> </ul>	<ul style="list-style-type: none"> <li>• Activating student interest and curiosity</li> <li>• Developing creativity and interpersonal skills and strategies</li> <li>• Exploring diverse possibilities</li> <li>• Forming hypotheses and developing concepts</li> <li>• Solving problems</li> <li>• Drawing inferences</li> </ul>	Students participating in: <ul style="list-style-type: none"> <li>• Discussions</li> <li>• Sharing</li> <li>• Generating alternative ways of thinking and feeling</li> <li>• Decision making</li> <li>• Debates</li> <li>• Role-playing</li> <li>• Panels</li> <li>• Brainstorming</li> <li>• Peer conferencing</li> <li>• Collaborative learning groups</li> <li>• Problem solving</li> <li>• Talking circles</li> <li>• Interviewing</li> <li>• Peer editing</li> </ul>	<ul style="list-style-type: none"> <li>• Increase of student motivation and learning through active involvement in groups</li> <li>• Key to success is teacher's knowledge and skill in forming groups, instructing, and guiding group dynamics</li> <li>• Effective in assisting students' development of life skills in cooperation and collaboration</li> </ul>
<b>Experiential Instruction</b>	<ul style="list-style-type: none"> <li>• Student-centred</li> <li>• Teacher's role may be to design the order and steps of the process</li> </ul>	<ul style="list-style-type: none"> <li>• Focusing on processes of learning rather than on products</li> <li>• Developing students' knowledge and experience</li> <li>• Preparing students for direct instruction</li> </ul>	Students participating in: <ul style="list-style-type: none"> <li>• Learning activities</li> <li>• Field trips</li> <li>• Simulations</li> <li>• Primary research</li> <li>• Games</li> <li>• Focused imaging</li> <li>• Role-playing</li> <li>• Surveys</li> <li>• Sharing observations and reflections</li> <li>• Reflecting critically on experiences</li> <li>• Developing hypotheses and generalizations in new situations</li> </ul>	<ul style="list-style-type: none"> <li>• Increase in student understanding and retention</li> <li>• Additional resources and time required for hands-on learning</li> </ul>
<b>Independent Study</b>	<ul style="list-style-type: none"> <li>• Student-centred</li> <li>• Teacher's role to guide or supervise students' independent study, teach knowledge, skills, and strategies that students require for independent learning, and provide adequate practice</li> </ul>	<ul style="list-style-type: none"> <li>• Accessing and developing student initiative</li> <li>• Developing student responsibility</li> <li>• Developing self-reliance and independence</li> </ul>	Students participating in: <ul style="list-style-type: none"> <li>• Inquiry and research projects</li> <li>• Using a variety of approaches and methods</li> <li>• Computer-assisted instruction</li> <li>• Essays and reports</li> <li>• Study guides</li> <li>• Learning contracts</li> <li>• Homework</li> <li>• Learning centres</li> </ul>	<ul style="list-style-type: none"> <li>• Students grow as independent, lifelong learners</li> <li>• Student maturity, knowledge, skills, and strategies important to success</li> <li>• Student access to resources essential</li> <li>• Approach flexible (may be used with individual students while other students use other approaches)</li> </ul>

### Linking Instructional Approaches with Specific Instructional Strategies

The interactions of the five instructional approaches just discussed can be linked to more specific strategies commonly found within this curriculum document. Although not exhaustive, the instructional strategies that follow may be used with Grade 12 Chemistry as starting points toward a broader array of strategically used classroom learning experiences with students.

#### *Direct Instruction*

- **Teacher demonstrations:** Demonstrations, such as discrepant events, may be used to arouse student interest and allow for visualization of phenomena. Demonstrations can activate prior knowledge and generate discussion around learning outcomes.
- **Community connections:** Field trips and guest speakers may provide students with opportunities to see science applied in their community and in local natural environments.
- **Prior knowledge activities:** Students learn best when they are able to relate new knowledge to what they already know. Brainstorming, KWL (Know, Want to know, Learned) charts, and Listen-Think-Pair-Share (see *SYSTH*, Chapter 9)\* are just a few of the strategies that may be used to activate and assess students' prior knowledge.

#### *Indirect Instruction*

- **Class discussion (teacher facilitated):** Discussions may be used in a variety of ways. They may spark interest in a topic or learning outcome, activate prior knowledge by inviting speculation on why certain events occur, or generate ideas for solutions to problems.
- **Collaborative teamwork:** Instructional strategies, such as the Jigsaw or Roundtable (see *SYSTH*, 3.19, 3.20, and Appendix 7), encourage students to learn from one another and to develop teamwork skills. The use of cooperative learning activities may lead to increased understanding of content and improved thinking skills.

#### *Interactive Instruction*

- **Class discussion (student facilitated):** Student-led discussions may be used with groups of students who are amenable to this form of interaction once procedures have been well developed in advance. They may spark interest in a topic or learning outcome, activate prior knowledge by inviting speculation on why certain events occur, or generate ideas for solutions to problems.
- **Debates:** Debates draw upon students' own positions on STSE issues. When carefully structured, debates may be used to encourage students' consideration of societal concerns and the opinions of others, and improve their communication and research skills.

---

\* For a discussion of these and other instructional strategies, see *Senior Years Science Teacher's Handbook* (Manitoba Education and Training) – abbreviated as *SYSTH* in this document.

### *Experiential Learning*

- **Student research/reports:** Learning projects that involve student research are among the most effective ways to individualize instruction in a diverse classroom. These learning activities provide students with opportunities to develop their research skills as they gather, process, and evaluate information.
- **Problem-based learning (PBL):** PBL is a curricular design that centres on an authentic problem. Students are assigned roles and presented with a problem that has no single, clear-cut solution. Students acquire content knowledge as they work toward solving the problem.
- **Journal writing:** Science journal writing allows students to explore and record various aspects of their experiences in science class. By sorting out their thoughts on paper or thinking about their learning (metacognition), students are better able to process what they are learning.
- **Laboratory activities:** Laboratory activities, whether student- or teacher-designed, provide students with opportunities to apply their scientific knowledge and skills related to a group of learning outcomes. Students will appreciate the hands-on experience of *doing* science, as opposed to a sense of just learning about science.

### *Independent Study*

- **WebQuests:** A WebQuest is an inquiry-oriented activity in which most or all of the information used by learners comes from resources on the Internet. WebQuests are designed to use learners' time well, to focus on using information rather than looking for it, and to support learners' thinking at the levels of analysis, synthesis, and evaluation.
- **Visual displays:** When students create visual displays, they make their thinking visible. Generating diagrams, concept maps, posters, and models provides students with opportunities to represent abstract information in a more concrete form.

### **Phases of Learning\***

When preparing instructional plans and goals, many teachers find it helpful to consider three learning phases:

- *activating* (preparing for learning)
- *acquiring* (integrating and processing learning)
- *applying* (consolidating learning)

These phases are not entirely linear but are a useful way of thinking and planning. A variety of activating, acquiring, and applying strategies are discussed in *Success for All Learners: A Handbook on Differentiating Instruction* and in *Senior Years Science Teachers' Handbook* (Manitoba Education and Training).

---

\* Source: Manitoba Education and Training. *Senior 4 English Language Arts: A Foundation for Implementation*. Winnipeg, MB: Manitoba Education and Training, 2000. Adapted from Section 2, pp. 12-15.



### *Activating (Preparing for Learning)*

One of the strongest indications of how well students will comprehend new information is their prior knowledge of the subject. Some educators observe that more student learning occurs during this activating phase than at any other time. In planning instruction and assessment, teachers develop student learning experiences and select strategies for activating their students' prior knowledge. Using these activating strategies, the learning experiences then provide information about the extent of students' prior knowledge of the topic to be studied, their knowledge of and familiarity with the context in which that knowledge was acquired, and their knowledge of and proficiency in applying skills for learning.

Learning experiences that draw on students' prior knowledge

- help students relate new information, skills, and strategies to what they already know and can do (e.g., if a text includes unfamiliar vocabulary, students may not recognize the connection between what they know and the new material being presented)
- allow teachers to recognize misconceptions that might make learning difficult for students
- allow teachers to augment and strengthen students' knowledge base when students do not possess adequate prior knowledge and experience to engage with new information and ideas
- help students recognize gaps in their knowledge
- stimulate curiosity and initiate the inquiry process that will direct learning

### *Acquiring (Integrating and Processing Learning)*

In the second phase of learning, students engage with new information and integrate it with what they already know, adding to and revising their previous knowledge. Part of the teacher's role in this phase is to present this new information or to help students access it from various resources.

Since learning is an internal process, however, facilitating learning requires more of teachers than simply presenting information. In the acquiring phase, teachers instruct students in strategies that help them make meaning of information, integrate it with what they already know, and express their new understanding. In addition, teachers monitor these processes to ensure that learning is taking place, using a variety of instruments, tools, and strategies such as observations, conferences, and examination of student work.

In practice, within an actual lesson or unit, the acquiring phase of learning may include a series of steps and strategies, such as

- setting the purpose (e.g., discrepant events, lesson overviews, learning logs, Admit Slips)
- presenting information (e.g., lab demonstrations, guest speakers, mini-lessons, active reading)
- processing information (e.g., note making, group discussions, journals, visual representations)

- modelling (e.g., role-playing, demonstrations)
- checking for understanding (e.g., quizzes, informal conferences)

### *Applying (Consolidating Learning)*

New learning that is not reinforced is soon forgotten. The products and performances by which students demonstrate new learning are not simply required for assessment; they have an essential instructional purpose in providing students with opportunities to demonstrate and consolidate their new knowledge, skills and strategies, and attitudes. Students also need opportunities to reflect on what they have learned and to consider how new learning applies to new situations. By restructuring information, expressing new ideas in another form, or integrating what they have learned in science with concepts from other subject areas, students strengthen and extend learning.

To ensure that students consolidate new learning, teachers plan various learning experiences involving

- reflection (e.g., journals, Exit Slips)
- closure (e.g., sharing of products, debriefing on processes)
- application (e.g., inquiry, design process)

### **Differentiating Instruction**

How can Senior Years science teachers meet each student's learning requirements and still make learning experiences challenging and meaningful for all? One way to help all students achieve the identified student learning outcomes is to differentiate the instructional strategies. Grade 12 Chemistry makes reference to a variety of field-validated strategies for differentiating instruction. Most have been taken from the support document *Senior Years Science Teachers' Handbook* (Manitoba Education and Training).

Through differentiating instruction, teachers can

- activate students' prior knowledge
- accommodate multiple intelligences and the variety of learning and thinking approaches
- help students interpret, apply, and integrate information
- facilitate the transfer of knowledge, skills and strategies, and attitudes to students' daily lives
- challenge students to realize academic and personal progress and achievement

Differentiating instruction does not mean offering different programming to each student. Classroom experiences can be differentiated by offering students choices and by varying instructional and assessment strategies to provide challenging and effective learning experiences for all. Ideas for differentiating instruction are provided in *Senior Years Science Teachers' Handbook* and in *Success for All Learners: A Handbook on Differentiating Instruction* (Manitoba Education and Training).

**Promoting Strategic Learning\***

Many of the tasks science students perform are problem-solving tasks, such as finding sources of information for an inquiry project, making meaning of a difficult text, or organizing a body of information. To solve problems, students require a strategic mindset; when confronted with a problem, students survey a number of possible strategies, select the one that seems likely to work best for the situation, and try an alternative method if the first one does not produce results.

Strategic learners in the sciences need to have not only a strategic mindset, but also a repertoire of strategies for making meaning, for processing information, and for expressing ideas and information effectively. Whereas skills are largely unconscious mental processes that learners use in accomplishing learning tasks, strategies are systematic and conscious plans, actions, and thoughts that learners select or invent and adapt to each task. Strategies are often described as “knowing what to do, how to do it, when to do it, and why it is useful.”

***Scaffolding: Supporting Students in Strategic Learning***

Many scientific tasks involve a complex interaction of skills. The most effective way to learn, however, is not by breaking down the tasks into manageable parts and teaching the skills separately and in isolation. In fact, this approach may be counterproductive. Purcell-Gates uses the analogy of learning to ride a bicycle, a skill that requires children to develop an intuitive sense of balance while also learning to pedal and steer. Children do not learn to ride a bicycle by focusing on only one of these skills at a time. Instead, they observe others who can ride a bicycle successfully, and then make an attempt themselves. In the early stages of learning to ride, a child counts on someone to provide support – to hold the bicycle upright while the child mounts, to keep a hand on the seat to stabilize the bicycle for the first few metres, and to coach and encourage. Gradually, these supports are withdrawn as the rider becomes more competent. Eventually, the process becomes automatic, and the rider is no longer aware of the skills being performed.

Providing this sort of support in teaching is called “scaffolding,” based on the work of Wood, Bruner, and Ross. Teachers scaffold by

- structuring tasks so that learners begin with something they can do
- reducing the complexity of tasks
- calling students’ attention to critical features of the tasks
- modelling steps
- providing sufficient guided and independent practice

---

\* Source: Manitoba Education and Training. *Senior 4 English Language Arts: A Foundation for Implementation*. Winnipeg, MB: Manitoba Education and Training, 2000. Adapted from Section 2, pp. 16–17.

In a sense, each learning strategy is an external support or scaffold. At first, working with a new strategy may be challenging and the main focus of students' attention. Eventually, students use the strategy automatically and rely on it as a learning tool. Students gradually internalize the process of the strategy. They begin to adjust and personalize the process and to apply the thinking behind the strategy automatically.

In strategic instruction, teachers observe and monitor students' use of a strategy for a time, intervening where necessary. Students vary in the length of time they require scaffolding. In this respect, strategic instruction is also a useful tool for differentiation. Struggling learners may work with simplified versions of a strategy, and they may continue to use the supports of a strategy (for example, a graphic organizer for laboratory reports) after other students have internalized the process.

Strategic instruction works best when teachers pace the instruction of new strategies carefully (so that students have time to practise each one), and when they teach a strategy in the context of a specific task of relevant scientific experience.

# SECTION 3:

## ASSESSMENT IN GRADE 12 CHEMISTRY

---

Classroom Assessment	3
Changing Emphases in Assessment	4
Purposes of Assessment	5
Assessment Strategies	7
Planning for Assessment	10
Characteristics of Effective Assessment	10
Managing Classroom Assessment	15



# ASSESSMENT IN GRADE 12 CHEMISTRY

---

## Classroom Assessment

Classroom assessment is an integral part of science instruction. Assessment could be described as the “systematic process of gathering information about what a student knows, is able to do, and is learning to do” (Manitoba Education and Training, *Reporting on Student Progress and Achievement* 5). The primary purpose of classroom assessment is not to evaluate and classify student performance, but to inform teaching and improve learning, and to monitor student progress in achieving year-end learning outcomes.

Rather than emphasizing the recall of specific, detailed and unrelated “facts,” [assessment in science] should give greater weight to an assessment of a holistic understanding of the major scientific ideas and a critical understanding of science and scientific reasoning (Millar and Osborne 25).

Classroom assessment is broadly defined as any activity or experience that provides information about student learning. Teachers learn about student progress not only through formal tests, examinations, and projects, but also through moment-by-moment observation of students in action. They often conduct assessment through instructional activities.

Much of students’ learning is internal. To assess students’ science knowledge, skills and strategies, and attitudes, teachers require a variety of tools and approaches. They ask questions, observe students engaged in a variety of learning activities and processes, and examine student work in progress. They also engage students in peer-assessment and self-assessment activities. The information that teachers and students gain from assessment activities informs and shapes what happens in the classroom; assessment always implies that some action will follow.

To determine whether student learning outcomes have been achieved, student assessment must be an integrated part of teaching and learning. Assessment of student learning involves careful planning and systematic implementation.

## Changing Emphases in Assessment

This view of effective assessment in science for Manitoba is reflective of changes in emphases in science education at the national level and is congruent with international changes in science education. The following chart summarizes some of the changes in the *assessment of student learning*, as envisioned in *National Science Education Standards* (National Research Council).

<b>Changing Emphases in Assessment of Student Learning*</b>	
The <i>National Science Education Standards</i> envision change throughout the system. The assessment standards encompass the following changes in emphases:	
<b>Less Emphasis On</b>	<b>More Emphasis On</b>
Assessing what is easily measured	Assessing what is most highly valued
Assessing discrete knowledge	Assessing rich, well-structured knowledge
Assessing scientific knowledge	Assessing scientific understanding and reasoning
Assessing to learn what students do not know	Assessing to learn what students do understand
Assessing only achievement	Assessing achievement and opportunity to learn
End-of-term assessments by teachers	Students engaged in ongoing assessment of their work and that of others
Development of external assessment by measurements experts alone	Teachers involved in the development of external assessments

\* Source: Reprinted with permission from *National Science Education Standards*, 1996 by the National Academy of Sciences, courtesy of the National Academies Press, Washington, DC.



## Purposes of Assessment

Assessment is integral to instruction and learning. It plays a major role in how students learn, their motivation to learn, and how teachers teach. Research indicates that ongoing formative assessment contributes more significantly to learning than the traditional focus on summative assessment does (Black and Wiliam). Manitoba Education refers to formative assessment as assessment *for* learning and assessment *as* learning.

Each type of assessment serves a purpose and contributes to student success:

- **Assessment *for* learning** helps teachers to gain insight into what students understand so that they can appropriately plan and differentiate teaching strategies and learning opportunities to help students progress. Students need frequent opportunities to obtain meaningful and relevant feedback. Descriptive feedback that includes analytical questions and constructive comments provides information to students that they may use to adjust their learning processes, and is more helpful to students than a numeric or alphabetic grade.
- **Assessment *as* learning** helps students to develop an awareness of how they learn and to use that awareness to adjust and advance their learning, taking an increased responsibility for their learning. When students have the opportunity to become reflective learners they can synthesize their learning, solve problems, apply their learning in authentic situations, and better understand their learning processes.
- **Assessment *of* learning** serves to confirm whether or not students have met curricular outcomes, and provides evidence of achievement to students, teachers, and parents, as well as to the broader educational community. Assessment of learning supports learning when it is used to celebrate success, adjust future instruction, and provide feedback to the learner.

Assessment must be planned with its purpose in mind. Assessment *for*, *as*, and *of* learning all have a role to play in supporting and improving student learning, and must be appropriately balanced. The most important part of assessment is the interpretation and use of the information that is gleaned for its intended purpose. For more information on assessment, consult *Rethinking Classroom Assessment with Purpose in Mind: Assessment for Learning, Assessment as Learning, Assessment of Learning* (Earl, Katz, and Western and Northern Canadian Protocol for Collaboration in Education).

<b>Overview of Planning Assessment*</b>			
	<b>Assessment for Learning</b>	<b>Assessment as Learning</b>	<b>Assessment of Learning</b>
Why Assess?	to enable teachers to determine next steps in advancing student learning	to guide and provide opportunities for each student to monitor and critically reflect on his or her learning and identify next steps	to certify or inform parents or others of student's proficiency in relation to curriculum learning outcomes
Assess What?	each student's progress and learning needs in relation to the curricular outcomes	each student's thinking about his or her learning, what strategies he or she uses to support or challenge that learning, and the mechanisms he or she uses to adjust and advance his or her learning	the extent to which students can apply the key concepts, knowledge, skills, and attitudes related to the curriculum outcomes
What Methods?	a range of methods in different modes that make students' skills and understanding visible	a range of methods in different modes that elicit students' learning and metacognitive processes	a range of methods in different modes that assess both product and process
Ensuring Quality	<ul style="list-style-type: none"> <li>accuracy and consistency of observations and interpretations of student learning</li> <li>clear, detailed learning expectations</li> <li>accurate, detailed notes for descriptive feedback to each student</li> </ul>	<ul style="list-style-type: none"> <li>accuracy and consistency of student's self-reflection, self-monitoring, and self-adjustment</li> <li>engagement of the student in considering and challenging his or her thinking</li> <li>students record their own learning</li> </ul>	<ul style="list-style-type: none"> <li>accuracy, consistency, and fairness of judgments based on high-quality information</li> <li>clear, detailed learning expectations</li> <li>fair and accurate summative reporting</li> </ul>
Using the Information	<ul style="list-style-type: none"> <li>provide each student with accurate feedback to further his or her learning</li> <li>differentiate instruction by continually checking where each student is in relation to the curricular outcomes</li> <li>provide parents or guardians with descriptive feedback about student learning and ideas for support</li> </ul>	<ul style="list-style-type: none"> <li>provide each student with accurate, descriptive feedback that will help him or her develop independent learning habits</li> <li>have each student focus on the task and his or her learning (not on getting the right answer)</li> <li>provide each student with ideas for adjusting, rethinking, and articulating his or her learning</li> <li>provide the conditions for the teacher and student to discuss alternatives</li> <li>students report about their learning</li> </ul>	<ul style="list-style-type: none"> <li>indicate each student's level of learning</li> <li>provide the foundation for discussions on placement or promotion</li> <li>report fair, accurate, and detailed information that can be used to decide the next steps in a student's learning</li> </ul>

\* Source: Earl, Lorna M., Steven Katz, and Western and Northern Canadian Protocol for Collaboration in Education. *Rethinking Classroom Assessment with Purpose in Mind: Assessment for Learning, Assessment as Learning, Assessment of Learning*. Winnipeg, MB: Manitoba Education, Citizenship and Youth, 2006. 85. Available online at [www.edu.gov.mb.ca/k12/assess/wncp/](http://www.edu.gov.mb.ca/k12/assess/wncp/).

### Assessment Strategies\*

A range of assessment strategies can be used in the chemistry classroom, including those described below. The same strategy can be used for both formative and summative assessment, depending on the purpose of the assessment. Teachers are encouraged to develop their own assessment for Senior Years science based on their students' learning requirements and the identified student learning outcomes.

- **Observation:** Observation of students is an integral part of the assessment process. It is most effective when focused on skills, concepts, and attitudes. Making brief notes on index cards, self-adhesive notes, or grids, as well as keeping checklists, helps teachers maintain records of continuous progress and achievement.
- **Interviews:** Interviews allow teachers to assess an individual's understanding and achievement of the student learning outcome(s). Interviews provide students with opportunities to model and explain their understandings. Interviews may be formal and informal. Posing science-related questions during planned interviews enables teachers to focus on individual student skills and attitudes. Students reveal their thinking processes and use of skills and strategies when they are questioned about how they solved problems or answered science questions. Using a prepared set of questions ensures that all interviews follow a similar structure. It is important to keep a record of student responses and/or understandings.
- **Group/peer assessment:** Group assessment gives students opportunities to assess how well they work within a group. Peer assessment gives them opportunities to reflect on one another's work, according to clearly established criteria. During the peer-assessment process, students must reflect on their own understanding in order to evaluate the performance of another student.
- **Self-assessment:** Self-assessment is vital to all learning and, therefore, integral to the assessment process. Each student should be encouraged to assess her or his own work. Students apply known criteria and expectations to their work and reflect on results to determine their progress toward the mastery of a specific learning outcome. Participation in setting self-assessment criteria and expectations helps students to see themselves as scientists and problem solvers. It is important that teachers model the self-assessment process before expecting students to assess themselves.
- **Science journal entries:** Science journal writing provides students with opportunities to reflect on their learning and to demonstrate their understanding using pictures, labelled drawings, and words. These journal entries can be powerful tools of formative assessment, allowing teachers to gauge a student's depth of understanding.

---

\* Source: Manitoba Education and Youth. *Senior 2 Science: A Foundation for Implementation*. Winnipeg, MB: Manitoba Education and Youth, 2003. Reprinted from pp. 48-50.

- **Rubrics/checklists:** Rubrics and checklists are tools that identify the criteria upon which student processes, performances, or products will be assessed. They also describe the qualities of work at various levels of proficiency for each criterion. Rubrics and checklists may be developed in collaboration with students.
- **Visual displays:** When individuals or groups of students prepare visual displays, they are involved in processing information and producing a knowledge framework. The completed work (e.g., poster, concept map, diagram, model) is the product with which teachers can determine what their students are thinking.
- **Laboratory reports:** Laboratory reports allow teachers to gauge the ability of students to observe, record, and interpret experimental results. These tools can aid teachers in determining how well students understand the content.
- **Pencil-and-paper tasks:** Quizzes can be used as discrete assessment tools, and tests can be larger assessment experiences. These written tasks may include items such as multiple-choice questions, completion of a drawing or labelled diagram, problem solving, or long-answer questions. Ensure that both restricted and extended expository responses are included in these assessment devices.
- **Research reports/presentations:** Research projects allow students to achieve the learning outcomes in individual ways. Assessment should be built into the project at every stage, from planning, to researching, to presenting the finished product.
- **Performance assessment/student demonstrations:** Performance tasks provide students with opportunities to demonstrate their knowledge, thinking processes, and skill development. The tasks require the application of knowledge and skills related to a group of learning outcomes. Performance-based tests do not test the information students possess, but the way their understanding of a subject has been deepened, and their ability to apply their learning in a simulated performance. A scoring rubric that includes a scale for the performance of the task helps organize and interpret evidence. Rubrics allow for a continuum of performance levels associated with the task being assessed.

### Performance-Based Assessment Approaches\*

The following performance-based assessment approaches and strategies can be used to assess student knowledge and skills:

- **Interpretation of media reports of science:** Short pieces extracted from newspapers could be used to assess the following: whether pupils understand the scientific content of the piece; whether they can identify and evaluate the possible risks and quality of the evidence presented; whether they can offer well-thought-out reactions to the claims; and, finally, whether they can give their opinions about future action that could be taken by individuals, governments, or other bodies.
- **Demonstration of an understanding of the major explanatory stories of science:** Questions should seek to examine observable results such as the following: whether students have understood, for example, what the particle model of matter is; whether they can give a short account of it; whether they can use it to explain everyday phenomena; and whether they can explain why it is an important idea in science.
- **Asking and answering questions based on data:** Such questions should assess students' abilities to represent data in a variety of ways; to formulate and interpret the messages that can be extracted from data; and to detect errors and dishonesty in the way data are presented or selected. The ability to manipulate and interpret data is a core skill that is of value, not only in science, but also in a wide range of other professions and contexts.
- **Recognizing the role of evidence:** At the heart of scientific rationality is a commitment to evidence. Contemporary science confronts the modern citizen with claims that are contested and uncertain. Questions based on historical or contemporary examples can be used to investigate students' understanding of the role of evidence in resolving competing arguments between differing theoretical accounts.

\* Source: Millar, Robin, and Jonathan Osborne, eds. *Beyond 2000: Science Education for the Future*. London, UK: King's College, 1998. 26. Adapted with permission.

## Planning for Assessment

Assessment purposes, approaches, and tools should be developed with instructional approaches during the planning of the unit. In developing assessment tasks and methods, teachers determine

- what they are assessing
- why they are assessing
- how the assessment information will be used
- who will receive the assessment information
- what assessment activities or tasks will allow students to demonstrate their learning in authentic ways

## Characteristics of Effective Assessment\*

Effective assessment helps focus effort on implementing strategies to facilitate learning both inside and outside the classroom. Effective assessment is

- congruent with instruction and integral to it
- ongoing and continuous
- based on authentic tasks and meaningful science-learning processes and contexts
- based on criteria that students know and understand and that appeal to their strengths
- a collaborative process involving students
- multi-dimensional and uses a wide range of tools and methods
- focused on what students have learned and can do

## Effective Assessment Is Congruent with (and Integral to) Instruction

Assessment requires teachers to be aware continually of the purpose of instruction: What do I want my students to learn? What can they do to show that they have learned it?

How teachers assess depends on what they are assessing – whether they are assessing declarative knowledge, procedural knowledge, or attitudes and habits of mind.

- **Declarative knowledge:** If teachers wish to measure fact-based recall, declarative knowledge is the most straightforward dimension of learning to measure using traditional tools. The purpose of fostering scientific literacy, however, is not met if students simply memorize the declarative knowledge related to science; what is more important is whether students understand and are able to apply this knowledge. For example, it is more important that they understand the purposes and effects of biodiversity, that they respond to and interpret what biodiversity means for them personally and environmentally, and that they use terminology

---

\* Source: Manitoba Education and Training. *Senior 3 English Language Arts: A Foundation for Implementation*. Winnipeg, MB: Manitoba Education and Training, 1999. Adapted from Section 2, pp. 10-14.

with ease to enrich their scientific communication skills, and represent – rather than reproduce – a definition of biodiversity. The challenge teachers face is to design tools that test the application of declarative knowledge.

- **Procedural knowledge:** Tools that are designed to test declarative knowledge cannot effectively assess skills and processes. For example, rather than trying to infer student processes by looking at final products, teachers assess procedural knowledge by observing students in action, by discussing their strategies with them in conferences and interviews, and by gathering data from student reflections, such as journals.
- **Attitudes and habits of mind:** Attitudes and habits of mind cannot be assessed directly. They are implicit in what students do and say. Assessment tools typically describe the behaviours that reflect the attitudes and habits of scientifically literate individuals. They identify the attitudes and habits of mind that enhance science-related language learning and use, and provide students with the means to reflect on their own internal processes. For example, rather than assigning global marks for class participation, teachers assess learning outcomes related to students' effective contributions to large and small groups.

Assessment is intended to inform students of the programming emphases and to help them focus on important aspects of learning. If teachers assess only the elements that are easiest to measure, students may focus only on those things. For example, if science courses place a high value on collaboration, creativity, and divergent thinking (learning outcomes that may be more difficult to measure), then assessment tools and processes must reflect those values. The ways teachers assess (what and how) inform students of what is considered important in learning.

### **Effective Assessment Is Ongoing and Continuous**

Assessment that is woven into daily instruction offers students frequent opportunities to gain feedback, to modify their learning approaches and methods, and to observe their progress. Teachers provide informal assessment by questioning students and offering comments. They also conduct formal assessments at various stages of a project or unit of study.

Continuous assessment provides ongoing opportunities for teachers to review and revise instruction, content, process emphases, and learning resources.

### **Effective Assessment Is Based on Authentic Tasks and Meaningful Science-Learning Processes and Contexts**

Assessment tasks in science should be authentic and meaningful – tasks worth mastering for their own sake, rather than tasks designed simply to demonstrate student proficiency for teachers and others. Through assessment, teachers discover whether students can use knowledge, processes, and resources effectively to achieve worthwhile purposes. Therefore, teachers design tasks that replicate the context in which knowledge will be applied in the world beyond the classroom.

For example, authentic science writing tasks employ the forms used by a wide range of people (for example, scientists, journalists, filmmakers, poets, novelists, publicists, speakers, technical writers, engineers, and academics). As often as possible, students write, speak, or represent their ideas for real audiences and for real purposes. In developing assessment tasks, teachers may consider providing students with the resources people use when performing the same tasks in real-life situations related to issues in science.

Authentic assessment tasks are tests not only of the information students possess, but also of the way their understanding of a subject has deepened, and of their ability to apply learning. They demonstrate to students the relevance and importance of learning. Performance-based tests are also a way of consolidating student learning. The perennial problem teachers have with “teaching to the test” is of less concern if tests are authentic assessments of student knowledge, skills and strategies, and attitudes.

### **Effective Assessment Is Based on Criteria That Students Know and Understand and That Appeal to Their Strengths**

Assessment criteria must be clearly established and made explicit to students before an assignment or a test so that students can focus their efforts. In addition, whenever possible, students need to be involved in developing assessment criteria. Appendix 10: Developing Assessment Rubrics in Science describes a process for creating assessment rubrics in collaboration with students.

Students should also understand clearly what successful accomplishment of each proposed task looks like. Models of student work from previous years and other exemplars assist students in developing personal learning goals.

Each assessment task should test only those learning outcomes that have been identified to students. This means, for example, that laboratory skills tests need to be devised and marked to gather information about students’ laboratory skills, not their ability to express ideas effectively when writing a laboratory report.

### **Effective Assessment Is a Collaborative Process Involving Students**

The ultimate purpose of assessment is to enable students to assess themselves. The gradual increase of student responsibility for assessment is aimed at developing students’ autonomy as lifelong learners. Assessment should decrease, rather than foster, students’ dependence on teachers’ comments for direction in learning and on marks for validation of their accomplishments.

Assessment enhances students’ metacognition. It helps them make judgements about their own learning, and provides them with information for goal setting and self-monitoring.

Teachers increase students’ responsibility for assessment by

- requiring students to select the products and performances to demonstrate their learning



- involving students in developing assessment criteria whenever possible (This clarifies the goals of a particular assignment and provides students with the vocabulary to discuss their own work.)
- involving students in peer assessment, informally through peer conferences and formally using checklists
- having students use tools for reflection and self-assessment at every opportunity (e.g., self-assessment checklists, journals, identification and selection of goals, self-assessment of portfolio items)
- establishing a protocol for students who wish to challenge a teacher-assigned mark (Formal appeals are valuable exercises in persuasive writing, and provide opportunities for students to examine their performance in light of the assessment criteria.)

### Effective Assessment Is Multi-Dimensional and Uses a Wide Range of Tools and Methods

Assessment in science must recognize the complexity and holistic nature of learning for scientific literacy. To compile a complete profile of each student's progress, teachers gather data using many different means over numerous occasions. Student profiles may involve both students and teachers in data gathering and assessment.

The following chart identifies areas for assessment and some suggested assessment instruments, tools, and methods.

<b>Data-Gathering Profile</b>			
<b>Observation of Processes</b>		<b>Observation of Products and Performances</b>	
Teacher: <ul style="list-style-type: none"> <li>• Checklists</li> <li>• Conferences and interviews</li> <li>• Anecdotal comments and records</li> <li>• Reviews of drafts and revisions</li> <li>• Oral presentations</li> <li>• Rubrics and marking scales</li> </ul>	Students: <ul style="list-style-type: none"> <li>• Journals</li> <li>• Self-assessment instruments and tools (e.g., checklists, rating scales, progress charts)</li> <li>• Peer-assessment instruments and tools (e.g., peer-conference records, rating scales)</li> </ul>	Teacher: <ul style="list-style-type: none"> <li>• Written assignments</li> <li>• Demonstrations</li> <li>• Presentations</li> <li>• Seminars</li> <li>• Projects</li> <li>• Portfolios</li> <li>• Student journals and notebooks</li> <li>• Checklists</li> <li>• Rubrics and marking scales</li> </ul>	Students: <ul style="list-style-type: none"> <li>• Journals</li> <li>• Self-assessment instruments and tools</li> <li>• Peer-assessment instruments and tools</li> <li>• Portfolio analysis</li> </ul>
<b>Classroom Tests</b>		<b>Divisional and Provincial Standards Tests</b>	
Teacher: <ul style="list-style-type: none"> <li>• Paper-and-pencil tests (e.g., teacher-made tests, unit tests, essay-style tests)</li> <li>• Performance tests and simulations</li> <li>• Rubrics and marking scales</li> </ul>	Students: <ul style="list-style-type: none"> <li>• Journals</li> <li>• Self-assessment instruments and tools</li> </ul>	Teacher marker: <ul style="list-style-type: none"> <li>• Rubrics and marking scales</li> </ul>	

### **Effective Assessment Focuses on What Students Have Learned and Can Do (Not on What They Have Not Learned or Cannot Do)**

Assessment must be equitable; it must offer opportunities for success to every student. Effective assessment demonstrates the knowledge, skills and strategies, and attitudes of each student and the progress the student is making, rather than simply identifying deficits in learning.

To assess what students have learned and can do, teachers need to use a variety of strategies and approaches, such as the following:

- Use a wide range of instruments to assess the multi-dimensional expressions of each student's learning, avoiding reliance upon rote recall or memorization.
- Provide students with opportunities to learn from feedback and to refine their work, recognizing that not every assignment will be successful, nor will it become part of a summative evaluation.
- Examine several pieces of student work in assessing any particular learning outcome to ensure that data collected are valid bases for making generalizations about student learning.
- Develop complete student profiles by using information from both learning-outcome-referenced assessment, which compares a student's performance to predetermined criteria, and self-referenced assessment, which compares a student's performance to her or his prior performance.
- Avoid using assessment for purposes of discipline or classroom control. Research has found that assessment that is perceived as a tool for controlling student behaviour, meting out rewards and punishments rather than providing feedback on student learning, reduces student motivation (Ryan, Connell, and Deci).

Students are sometimes assigned a mark of zero for incomplete work. Averaging a zero into the student's mark, however, means the mark no longer communicates accurate information about the student's achievement of science learning outcomes. Unfinished assignments signal personal or motivational problems that need to be addressed in appropriate and alternative ways.

- Allow students, when appropriate and possible, to choose how they will demonstrate their competence.
- Use assessment tools appropriate for assessing individual and unique products, processes, and performances.

## **Managing Classroom Assessment\***

Assessment is one of the greatest challenges science teachers face. The practices that make science classrooms vital and effective (promoting student choice, assessing processes, and assessing the subjective aspect of learning) make assessment a complex matter.

Systems and supports that may assist teachers in managing assessment include

- dispensing with ineffectual means of assessment
- using time savers
- sharing the load
- taking advantage of technology
- establishing systems of recording assessment information

A discussion of these suggestions follows.

### **Dispensing with Ineffectual Means of Assessment**

Teachers need to question the efficacy, for example, of writing lengthy commentaries on summative assessment of student projects. Detailed comments are best provided as formative assessment (when students can make immediate use of the feedback) and shared orally in conferences (which provide opportunities for student-teacher discussion).

The time spent in assessment needs to be learning time, both for the teacher and the student.

### **Using Time Savers**

Many effective assessment tools are time savers. Developing checklists and rubrics is time-consuming; however, well-written rubrics may eliminate the need to write extensive comments, and may mean that student performances can be assessed largely during class time.

### **Sharing the Load**

While the ultimate responsibility for assessment rests with the teacher, student self-assessment also provides a wealth of information. Collaborating with students to generate assessment criteria is part of effective instruction. Grade 12 students may develop checklists and keep copies of their own goals in an assessment binder for periodic conferences. Students may be willing to contribute work samples to be used as models in other classes.

Collaborating with other teachers in creating assessment tools saves time and provides opportunities to discuss assessment criteria.

---

\* Source: Manitoba Education and Training. *Senior 2 English Language Arts: A Foundation for Implementation*. Winnipeg, MB: Manitoba Education and Training, 1998. Adapted from Assessment, pp. 9-10.

### **Taking Advantage of Technology**

Electronic tools (e.g., audiotapes, videotapes, and computer files) can assist teachers in making and recording observations. Word processors allow teachers to save, modify, and reuse task-specific checklists and rubrics.

### **Establishing Systems for Recording Assessment Information**

Collecting data from student observations is especially challenging for Senior Years teachers, who may teach several classes of students in a given semester or term. Teachers may want to identify a group of students in each class for observation each week. Binders, card files, and electronic databases are useful for record keeping, as are self-adhesive notes recording brief observations on student files, which can later be transformed into anecdotal reports.

Teachers may also want to develop comprehensive forms for listing the identified learning outcomes, and for recording data.

# SECTION 4:

## DOCUMENT ORGANIZATION

---

Document Organization and Format	3
Guide to Reading the Learning Outcomes and the Document Format	3
Sample Two-Page Layout	6
General Learning Outcomes	8
Cluster 0: Skills and Attitudes Outcomes	10
Specific Learning Outcomes	13



# DOCUMENT ORGANIZATION

---

## Document Organization and Format

The suggestions for instruction and assessment contained within *Grade 12 Chemistry: A Foundation for Implementation* provide teachers with strategies for assisting students in achieving the general and specific learning outcomes identified for this curriculum. The instructional and assessment suggestions offer teachers a range of strategies from which to select appropriate directions with students. Although they are not prescriptive, the strategies presented can be considered starting points from which teachers can include their own initiatives, style, and effective techniques to foster learning.

The topic-related appendices (found at the end of each topic) and the general appendices (found at the end of this document) provide additional information on student learning activities, teacher support materials related to instruction and assessment, and a variety of assessment rubrics. These complementary resources are closely linked to the learning outcomes and to the skills and attitudes outcomes, and are designed to support, facilitate, and enhance student learning.

At-a-glance listings of the general learning outcomes, skills and attitudes outcomes, and specific learning outcomes for Grade 12 Chemistry are provided at the end of this section of this document, as well as in Appendix 12.

## Guide to Reading the Learning Outcomes and the Document Format

The specific learning outcomes identified for Grade 12 Chemistry are organized according to the following five thematic topics:

- Topic 1: Reactions in Aqueous Solutions
- Topic 2: Atomic Structure
- Topic 3: Chemical Kinetics
- Topic 4: Chemical Equilibrium
- Topic 5: Acids and Bases
- Topic 6: Electrochemistry

The suggested strategies for implementing the curriculum outcomes within each chemistry topic include the following components:

- **Specific Learning Outcomes (SLOs):** The SLOs identified at the top of each page outline the intended learning to be achieved by the student by the end of the course. They include the SLOs related to the particular chemistry topic, in addition to the learning outcomes related to Cluster 0: Skills and Attitudes, selected to correspond to the Suggestions for Instruction.
- **General Learning Outcome (GLO) Connections:** The GLOs provide links across the entire scope of the Kindergarten to Grade 12 continuum of learning in science. These GLOs provide connections to the Five Foundations for Scientific Literacy that guide all Manitoba science curricula in all science discipline areas.

- **Suggestions for Instruction:** The instructional strategies relate directly to the achievement of the identified SLOs.
  - **Entry-Level Knowledge:** Students will have prior knowledge in relation to some learning outcomes. Identification of students' entry-level knowledge, where included, links instructors to key areas of the science curriculum from previous years, providing information about where students should be in relation to the present learning outcomes. Prior knowledge learning activities can then be used to provide students with a rationale about what is to come or to refresh conceptual or procedural knowledge that has lapsed over time.
  - **Student Learning Activities:** Student learning activities are suggested for all learning outcomes. The examples of teacher-facilitated instructional strategies presented in this document are designed to be student-centred, engaging the learner directly in some contextual way.
- **Teacher Notes:** Incorporated throughout this document as needed, these notes provide teachers with definitions and content background (often beyond what students are required to know), planning hints, special-interest material, cautions and safety information, and depth of treatment on certain issues related to the identified learning outcomes.
- **Suggestions for Assessment:** These suggestions offer strategies for assessing students' achievement of the specific learning outcomes.
- **Learning Resources Links:** The links to additional chemistry resources are intended to guide and support instruction, the learning process, and student assessment. While only titles, authors, and page references are provided in the Learning Resources Links for the specific learning outcome(s), the complete bibliographic information is cited in the Bibliography of this document. It is important to recognize that new editions of standard texts in the field of chemistry can be expected about every two years – often with minimal changes to content. The editions of learning resources identified in this document include those that were used directly in the preparation of *Grade 12 Chemistry: A Foundation for Implementation*. Teachers are encouraged to seek out newer versions of texts considered as “standards in the field.”

The following resources are cited most frequently in the **Learning Resources Links**:

- Chang, Raymond. *Chemistry*. 9th ed. Boston, MA: McGraw-Hill Higher Education, 2007.
- Chastko, Audrey, Jeff Goldie, Frank Mustoe, Ian Phillips, and Sandy Searle. *McGraw-Hill Ryerson Inquiry into Chemistry*. Toronto, ON: McGraw-Hill Ryerson, 2007.
- Davies, Lucille, Maurice Di Giuseppe, Ted Gibb, Milan Sanader, and Angela Vavitsas. *Nelson Chemistry 12: College Preparation*. Ontario Edition. Toronto, ON: Thomson Nelson, 2003.
- Davis, Joseph E., W. Keith McNab, Edward L. Haenisch, A. L. McClellan, and Paul R. O'Connor. *Laboratory Manual for Chemistry: Experiments and Principles*. Lexington, MA: D.C. Heath and Company, 1968.
- Dingrando, Laurel, Kathleen (Gregg) Tallman, Nichols Hainen, and Cheryl Wistrom. *Glencoe Chemistry: Matter and Change*. Columbus, OH: Glencoe/McGraw-Hill, 2005.



- \_\_\_\_\_. *Glencoe Chemistry: Matter and Change: ChemLab and MiniLab Worksheets*. Columbus, OH: Glencoe/McGraw-Hill, 2002.
- \_\_\_\_\_. *Glencoe Chemistry: Matter and Change, Laboratory Manual*. Columbus, OH: Glencoe/McGraw-Hill, 2005.
- \_\_\_\_\_. *Glencoe Chemistry: Matter and Change: Small-Scale Laboratory Manual, Teacher Edition*. Columbus, OH: Glencoe/McGraw-Hill, 2002.
- \_\_\_\_\_. *Glencoe Chemistry: Matter and Change, Teacher Wraparound Edition*. Columbus, OH: Glencoe/McGraw-Hill, 2005.
- Fisher, Douglas. *Glencoe Chemistry: Matter and Change, Science Notebook*. Columbus, OH: Glencoe/McGraw-Hill, 2005.
- Jenkins, Frank, Hans van Kessel, Lucille Davies, Oliver Lantz, Patricia Thomas, and Dick Tompkins. *Nelson Chemistry 11*. Ontario Edition. Toronto, ON: Nelson Thomson Learning, 2002.
- Manitoba Education and Training. *Senior Years Science Teachers' Handbook: A Teaching Resource*. Winnipeg, MB: Manitoba Education and Training, 1997.
- Merrill, Phyllis, Robert W. Parry, and Robert L. Tellefsen. *Chemistry: Experimental Foundations, Laboratory Manual*. 3rd ed. Englewood Cliffs, NJ: Prentice Hall, Inc., 1982.
- Mustoe, Frank, Michael P. Jansen, Ted Doram, John Ivanco, Christina Clancy, and Anita Ghazariansteja. *McGraw-Hill Ryerson Chemistry*. Combined Atlantic Edition. Toronto, ON: McGraw-Hill Ryerson, 2004.
- Penrose, Mike, Ted Gibb, Milan Sanader, and Angela Vavitsas. *Nelson Chemistry 12: College Preparation Teacher's Resource*. Toronto, ON: Nelson, 2004.
- Phillips, John S., Victor S. Strozak, and Cheryl Wistrom. *Glencoe Chemistry: Concepts and Applications*. Columbus, OH: Glencoe/McGraw-Hill, 2005.
- Silberberg, Martin S. *Chemistry: The Molecular Nature of Matter and Change*. 3rd ed. Boston, MA: McGraw-Hill Higher Education, 2003.
- Slater, A., and G. Rayner-Canham. *Microscale Chemistry Laboratory Manual*. Reading, MA: Addison-Wesley Publishers Limited, 1994.
- van Kessel, Hans, Frank Jenkins, Lucille Davies, Donald Plumb, Maurice Di Giuseppe, Oliver Lanz, and Dick Tompkins. *Nelson Chemistry 12*. Ontario Edition. Toronto, ON: Thomson Nelson, 2003.
- Wagner, Maxine. *Prentice Hall Chemistry: The Study of Matter, Laboratory Manual*. 3rd ed. Needham, MA: Prentice Hall, Inc., 1989.
- Waterman, Edward L., and Stephen Thompson. *Prentice Hall Chemistry: Small-Scale Chemistry Laboratory Manual*. Boston, MA: Pearson Prentice Hall, 2004.
- Whitman, Ronald Laurie, and Ernest E. Zinck. *Prentice Hall Chemistry Today: Laboratory Manual*. Scarborough, ON: Prentice-Hall of Canada, 1976.
- Wilbraham, Antony C., Dennis D. Staley, and Michael S. Matta. *Prentice Hall Chemistry: Laboratory Manual*. Boston, MA: Pearson Prentice Hall, n.d.
- \_\_\_\_\_. *Prentice Hall Chemistry: Laboratory Manual, Teacher's Edition*. Boston, MA: Pearson Prentice Hall, n.d.
- Wilbraham, Antony C., Dennis D. Staley, Michael S. Matta, and Edward L. Waterman. *Prentice Hall Chemistry*. Upper Saddle River, NJ: Pearson Education/Prentice Hall, 2005.
- \_\_\_\_\_. *Prentice Hall Chemistry: Small-Scale Chemistry Laboratory Manual*. Upper Saddle River, NJ: Pearson Education/Prentice Hall, 2005.
- Zumdahl, Steven S., and Susan A. Zumdahl. *Chemistry*. 5th ed. Boston, MA: Houghton-Mifflin, 2000.

## Sample Two-Page Layout

The following clarification on reading the document format is based on a sample two-page layout from *Grade 12 Chemistry: A Foundation for Implementation*.

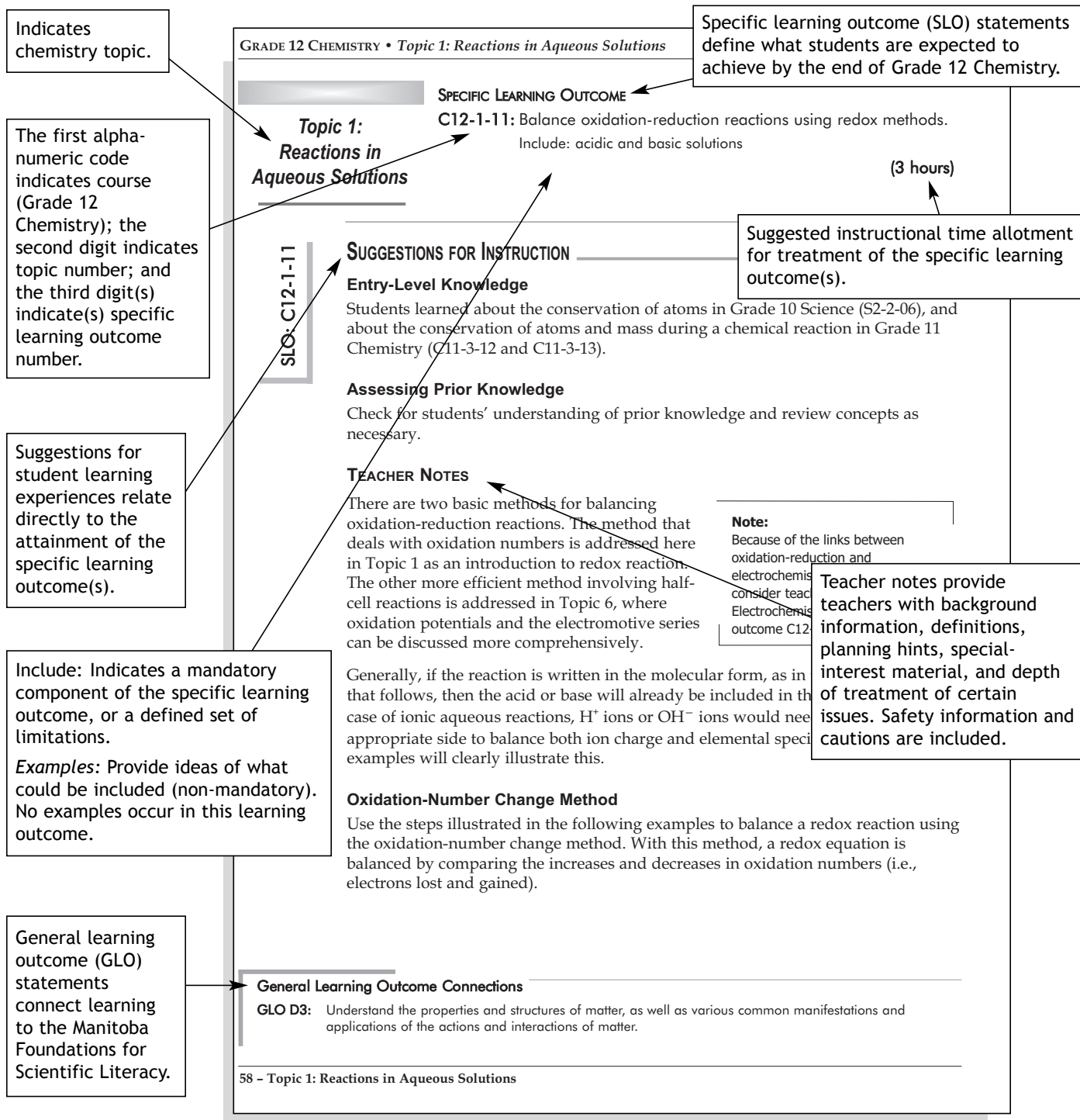

Skills and attitudes learning outcomes define expectations across all topics in Grade 12 Chemistry.

GRADE 12 CHEMISTRY • Topic 1: Reactions in Aqueous Solutions

**SKILLS AND ATTITUDES OUTCOMES**

**C12-O-U1:** Use appropriate strategies and skills to develop an understanding of chemical concepts.

*Examples: analogies, concept frames, concept maps, manipulatives, particulate representations, role-plays, simulations, sort-and-predict frames, word cycles . . .*

**C12-O-U2:** Demonstrate an understanding of chemical concepts.

*Examples: use accurate scientific vocabulary, explain concepts to others, compare and contrast concepts, apply knowledge to new situations and/or contexts, create analogies, use manipulatives . . .*

**SUGGESTIONS FOR ASSESSMENT**

**Paper-and-Pencil Task**

Have students balance redox equations using process notes (see SYSTH 13.14).

**Journal Writing**

Students may wish to write an account of the technology that goes into the functioning and use of a traditional breathalyzer.

**LEARNING RESOURCES LINKS**



*Glencoe Chemistry: Concepts and Applications* (Phillips, Strozak, and Wistrom)  
Breathalyzer Test, 569

*Glencoe Chemistry: Matter and Change* (Dingrando, et al.)  
Section 20.2: Balancing Redox Equations, 644  
The Oxidation-Number Method, 644  
Section 20.3: Half-Reactions, 650

*McGraw-Hill Ryerson Chemistry, Combined Atlantic Edition* (Mustoe, et al.)  
18.2: Oxidation Numbers, 721  
18.3: The Half-Reaction Method for Balancing Equations, 730

*Prentice Hall Chemistry* (Wilbraham, et al.)  
Section 20.3: Balancing Redox Equations, 645

**Selecting Learning Resources**

For additional information on selecting learning resources for Grade 11 and Grade 12 Chemistry, see the Manitoba Education website at <[www.edu.gov.mb.ca/k12/learnres/bibliographies.html](http://www.edu.gov.mb.ca/k12/learnres/bibliographies.html)>.

Suggested assessment strategies relate directly to assessing student achievement of the specific learning outcome(s).

Links indicate the titles, authors, and page references (or URLs) where SLO-related content is treated within the various learning resources.

## General Learning Outcomes

General learning outcomes (GLOs) provide connections to the Five Foundations for Scientific Literacy that guide all Manitoba science curricula in all science discipline areas.

### Nature of Science and Technology

As a result of their Senior Years science education, students will:

- A1 Recognize both the power and limitations of science as a way of answering questions about the world and explaining natural phenomena.
  - A2 Recognize that scientific knowledge is based on evidence, models, and explanations, and evolves as new evidence appears and new conceptualizations develop.
  - A3 Distinguish critically between science and technology in terms of their respective contexts, goals, methods, products, and values.
  - A4 Identify and appreciate contributions made by women and men from many societies and cultural backgrounds that have increased our understanding of the world and brought about technological innovations.
  - A5 Recognize that science and technology interact with and advance one another.
- 

### Science, Technology, Society, and the Environment (STSE)

As a result of their Senior Years science education, students will:

- B1 Describe scientific and technological developments—past and present—and appreciate their impact on individuals, societies, and the environment, both locally and globally.
  - B2 Recognize that scientific and technological endeavours have been and continue to be influenced by human needs and the societal context of the time.
  - B3 Identify the factors that affect health, and explain the relationships among personal habits, lifestyle choices, and human health, both individual and social.
  - B4 Demonstrate knowledge of and personal consideration for a range of possible science- and technology-related interests, hobbies, and careers.
  - B5 Identify and demonstrate actions that promote a sustainable environment, society, and economy, both locally and globally.
-

**Scientific and Technological Skills and Attitudes**

As a result of their Senior Years science education, students will:

- C1 Recognize safety symbols and practices related to scientific and technological activities and to their daily lives, and apply this knowledge in appropriate situations.
  - C2 Demonstrate appropriate scientific inquiry skills when seeking answers to questions.
  - C3 Demonstrate appropriate problem-solving skills when seeking solutions to technological challenges.
  - C4 Demonstrate appropriate critical thinking and decision-making skills when choosing a course of action based on scientific and technological information.
  - C5 Demonstrate curiosity, skepticism, creativity, open-mindedness, accuracy, precision, honesty, and persistence, and appreciate their importance as scientific and technological habits of mind.
  - C6 Employ effective communication skills and use information technology to gather and share scientific and technological ideas and data.
  - C7 Work cooperatively and value the ideas and contributions of others while carrying out scientific and technological activities.
  - C8 Evaluate, from a scientific perspective, information and ideas encountered during investigations and in daily life.
- 

**Essential Science Knowledge**

As a result of their Senior Years science education, students will:

- D1 Understand essential life structures and processes pertaining to a wide variety of organisms, including humans.
  - D2 Understand various biotic and abiotic components of ecosystems, as well as their interaction and interdependence within ecosystems and within the biosphere as a whole.
  - D3 Understand the properties and structures of matter, as well as various common manifestations and applications of the actions and interactions of matter.
  - D4 Understand how stability, motion, forces, and energy transfers and transformations play a role in a wide range of natural and constructed contexts.
  - D5 Understand the composition of the Earth's atmosphere, hydrosphere, and lithosphere, as well as the processes involved within and among them.
  - D6 Understand the composition of the universe, the interactions within it, and the implications of humankind's continued attempts to understand and explore it.
-

### Unifying Concepts

As a result of their Senior Years science education, students will:

- E1 Describe and appreciate the similarity and diversity of forms, functions, and patterns within the natural and constructed world.
  - E2 Describe and appreciate how the natural and constructed world is made up of systems and how interactions take place within and among these systems.
  - E3 Recognize that characteristics of materials and systems can remain constant or change over time, and describe the conditions and processes involved.
  - E4 Recognize that energy, whether transmitted or transformed, is the driving force of both movement and change, and is inherent within materials and in the interactions among them.
- 

### Cluster 0: Skills and Attitudes Outcomes

In Grade 12 Chemistry, Cluster 0 comprises four categories of specific learning outcomes that describe the skills and attitudes involved in scientific inquiry and the decision-making process for science, technology, society, and the environment (STSE) issues. From Grades 5 to 10, students develop scientific inquiry through the development of a hypothesis/prediction, the identification and treatment of variables, and the formation of conclusions. Students begin to make decisions based on scientific facts and refine their decision-making skills as they progress through the grades, gradually becoming more independent. Students also develop key attitudes, an initial awareness of the nature of science, and other skills related to research, communication, the use of information technology, and cooperative learning.

In Grade 12 Chemistry, students continue to use scientific inquiry as an important process in their science learning, but also recognize that STSE issues require a more sophisticated treatment through the decision-making process.

Teachers should select appropriate contexts to introduce and reinforce scientific inquiry, the decision-making process, and positive attitudes within the thematic topics (Topics 1 to 6) throughout the school year. To assist in planning and to facilitate curricular integration, many specific learning outcomes within the Skills and Attitudes cluster can link to specific learning outcomes in other subject areas.

### Demonstrating Understanding

**C12-0-U1** Use appropriate strategies and skills to develop an understanding of chemical concepts.

*Examples: analogies, concept frames, concept maps, manipulatives, particulate representations, role-plays, simulations, sort-and-predict frames, word cycles . . .*

**C12-0-U2** Demonstrate an understanding of chemical concepts.

*Examples: use accurate scientific vocabulary, explain concepts to others, compare and contrast concepts, apply knowledge to new situations and/or contexts, create analogies, use manipulatives . . .*

---

**Scientific Inquiry**

- C12-0-S1** Demonstrate work habits that ensure personal safety and the safety of others, as well as consideration for the environment.  
Include: knowledge and use of relevant safety precautions, Workplace Hazardous Materials Information System (WHMIS), and emergency equipment
- C12-0-S2** State a testable hypothesis or prediction based on background data or on observed events.
- C12-0-S3** Design and implement an investigation to answer a specific scientific question.  
Include: materials, independent and dependent variables, controls, methods, and safety considerations
- C12-0-S4** Select and use scientific equipment appropriately and safely.  
*Examples: volumetric glassware, balance, thermometer . . .*
- C12-0-S5** Collect, record, organize, and display data using an appropriate format.  
*Examples: labelled diagrams, graphs, multimedia applications, software integration, probeware . . .*
- C12-0-S6** Estimate and measure accurately using Système International (SI) and other standard units.  
Include: SI conversions and significant figures
- C12-0-S7** Interpret patterns and trends in data, and infer and explain relationships.
- C12-0-S8** Evaluate data and data-collection methods for accuracy and precision.  
Include: discrepancies in data, sources of error, and percent error
- C12-0-S9** Draw a conclusion based on the analysis and interpretation of data.  
Include: cause-and-effect relationships, alternative explanations, and supporting or rejecting a hypothesis or prediction
- 

**Research**

- C12-0-R1** Synthesize information obtained from a variety of sources.  
Include: print and electronic sources, specialists, and other resource people
- C12-0-R2** Evaluate information obtained to determine its usefulness for information needs.  
*Examples: scientific accuracy, reliability, currency, relevance, balance of perspectives, bias . . .*
- C12-0-R3** Quote from or refer to sources as required and reference information sources according to an accepted practice.
- C12-0-R4** Compare diverse perspectives and interpretations in the media and other information sources.
- C12-0-R5** Communicate information in a variety of forms appropriate to the audience, purpose, and context.
-

### **Communication and Teamwork**

**C12-0-C1** Collaborate with others to achieve group goals and responsibilities.

**C12-0-C2** Elicit, clarify, and respond to questions, ideas, and diverse points of view in discussions.

**C12-0-C3** Evaluate individual and group processes.

---

### **Nature of Science**

**C12-0-N1** Explain the roles of theory, evidence, and models in the development of scientific knowledge.

**C12-0-N2** Describe, from a historical perspective, how the observations and experimental work of many individuals led to modern understandings of matter.

**C12-0-N3** Describe how scientific knowledge changes as new evidence emerges and/or new ideas and interpretations are advanced.

---

### **STSE**

**C12-0-T1** Describe examples of the relationship between chemical principles and applications of chemistry.

**C12-0-T2** Explain how scientific research and technology interact in the production and distribution of beneficial materials.

**C12-0-T3** Provide examples of how chemical principles are applied in products and processes, in scientific studies, and in daily life.

---

### **Attitudes**

**C12-0-A1** Demonstrate confidence in their ability to carry out investigations in chemistry and to address STSE-related issues.

**C12-0-A2** Value skepticism, honesty, accuracy, precision, perseverance, and open-mindedness as scientific and technological habits of mind.

**C12-0-A3** Demonstrate a continuing, increasingly informed interest in chemistry and chemistry-related careers and issues.

**C12-0-A4** Be sensitive and responsible in maintaining a balance between the needs of humans and a sustainable environment.

---



## Specific Learning Outcomes

The specific learning outcomes (SLOs) identified here constitute the intended learning to be achieved by the student by the end of Grade 12 Chemistry. These statements clearly define what students are expected to achieve and/or be able to perform at the end of the course. These SLOs, combined with the Skills and Attitudes SLOs, constitute the source upon which assessment and instructional design are based.

### Topic 1: Reactions in Aqueous Solutions

- C12-1-01** Explain examples of solubility and precipitation at the particulate and symbolic levels.
- C12-1-02** Perform a laboratory activity to develop a set of solubility rules.
- C12-1-03** Use a table of solubility rules to predict the formation of a precipitate.
- C12-1-04** Write balanced neutralization reactions involving strong acids and bases.
- C12-1-05** Perform a laboratory activity to demonstrate the stoichiometry of a neutralization reaction between a strong base and a strong acid.
- C12-1-06** Calculate the concentration or volume of an acid or a base from the concentration and volume of an acid or a base required for neutralization.
- C12-1-07** Design and test a procedure to determine the identity of a variety of unknown solutions.
- C12-1-08** Outline the development of scientific understanding of oxidation and reduction reactions.  
Include: gain and loss of electrons, oxidizing agent, and reducing agent
- C12-1-09** Determine the oxidation numbers for atoms in compounds and ions.
- C12-1-10** Identify reactions as redox or non-redox.  
Include: oxidizing agent, reducing agent, oxidized substance, and reduced substance
- C12-1-11** Balance oxidation-reduction reactions using redox methods.  
Include: acidic and basic solutions
- C12-1-12** Research practical applications of redox reactions.  
*Examples: rocket fuels, fireworks, household bleach, photography, metal recovery from ores, steel making, aluminum recycling, fuel cells, batteries, tarnish removal, fruit clocks, forensic blood detection using luminol, chemiluminescence/ bioluminescence, electrolytic cleaning, electrodeposition, photochemical etching, antioxidants/ preservatives . . .*
-

## Topic 2: Atomic Structure

- C12-2-01** Describe qualitatively the electromagnetic spectrum in terms of frequency, wavelength, and energy.
- C12-2-02** Recognize, through direct observation, that elements have unique line spectra.  
Include: flame tests or gas discharge tubes and spectroscopes or diffraction gratings
- C12-2-03** Describe applications and/or natural occurrences of line spectra.  
*Examples: astronomy, aurora borealis, fireworks, neon lights . . .*
- C12-2-04** Outline the historical development of the quantum mechanical model of the atom.
- C12-2-05** Write electron configurations for elements of the periodic table.  
Include: selected elements up to atomic number 36 (krypton)
- C12-2-06** Relate the electron configuration of an element to its valence electron(s) and its position on the periodic table.
- C12-2-07** Identify and account for periodic trends among the properties of elements, and relate the properties to electron configuration.  
Include: atomic radii, ionic radii, ionization energy, and electronegativity
- 

## Topic 3: Chemical Kinetics

- C12-3-01** Formulate an operational definition of *reaction rate*.  
Include: examples of chemical reactions that occur at different rates
- C12-3-02** Identify variables used to monitor reaction rates (i.e., change per unit of time,  $\Delta x / \Delta t$ ).  
*Examples: pressure, temperature, pH, conductivity, colour . . .*
- C12-3-03** Perform a laboratory activity to measure the average and instantaneous rates of a chemical reaction.  
Include: initial reaction rate
- C12-3-04** Relate the rate of formation of a product to the rate of disappearance of a reactant, given experimental rate data and reaction stoichiometry.  
Include: descriptive treatment at the particulate level
- C12-3-05** Perform a laboratory activity to identify factors that affect the rate of a chemical reaction.  
Include: nature of reactants, surface area, concentration, pressure, volume, temperature, and presence of a catalyst
- C12-3-06** Use the collision theory to explain the factors that affect the rate of chemical reactions.  
Include: activation energy and orientation of molecules
-

- C12-3-07** Draw potential energy diagrams for endothermic and exothermic reactions.  
Include: relative rates, effect of a catalyst, and heat of reaction (enthalpy change)
- C12-3-08** Describe qualitatively the relationship between the factors that affect the rate of chemical reactions and the relative rate of a reaction, using the collision theory.
- C12-3-09** Explain the concept of a reaction mechanism.  
Include: rate-determining step
- C12-3-10** Determine the rate law and order of a chemical reaction from experimental data.  
Include: zero-, first-, and second-order reactions and reaction rate versus concentration graphs
- 

#### Topic 4: Chemical Equilibrium

- C12-4-01** Relate the concept of equilibrium to physical and chemical systems.  
Include: conditions necessary to achieve equilibrium
- C12-4-02** Write equilibrium law expressions from balanced chemical equations for heterogeneous and homogeneous systems.  
Include: mass action expression
- C12-4-03** Use the value of the equilibrium constant ( $K_{\text{eq}}$ ) to explain how far a system at equilibrium has gone towards completion.
- C12-4-04** Solve problems involving equilibrium constants.
- C12-4-05** Perform a laboratory activity to determine the equilibrium constant of an equilibrium system.
- C12-4-06** Use Le Châtelier's principle to predict and explain shifts in equilibrium.  
Include: temperature changes, pressure/volume changes, changes in reactant/product concentration, the addition of a catalyst, the addition of an inert gas, and the effects of various stresses on the equilibrium constant
- C12-4-07** Perform a laboratory activity to demonstrate Le Châtelier's principle.
- C12-4-08** Interpret concentration versus time graphs.  
Include: temperature changes, concentration changes, and the addition of a catalyst
- C12-4-09** Describe practical applications of Le Châtelier's principle.  
*Examples: Haber process, hemoglobin production at high altitude, carbonated beverages, eyes adjusting to light, blood pH, recharging of batteries, turbocharged/supercharged engines, ester synthesis, weather indicators, arrangement of produce, carbonated beverages in a hen's diet . . .*
- C12-4-10** Write solubility product ( $K_{\text{sp}}$ ) expressions from balanced chemical equations for salts with low solubility.
-

- C12-4-11** Solve problems involving  $K_{sp}$ .  
Include: common ion problems
- C12-4-12** Describe examples of the practical application of salts with low solubility.  
*Examples: kidney stones, limestone caverns, osteoporosis, tooth decay . . .*
- C12-4-13** Perform a laboratory activity to determine the  $K_{sp}$  of a salt with low solubility.
- 

### **Topic 5: Acids and Bases**

- C12-5-01** Outline the historical development of acid-base theories.  
Include: the Arrhenius, Brønsted-Lowry, and Lewis theories
- C12-5-02** Write balanced acid-base chemical equations.  
Include: conjugate acid-base pairs and amphoteric behaviour
- C12-5-03** Describe the relationship between the hydronium and hydroxide ion concentrations in water.  
Include: the ion product of water,  $K_w$
- C12-5-04** Perform a laboratory activity to formulate an operational definition of  $pH$ .
- C12-5-05** Describe how an acid-base indicator works in terms of colour shifts and Le Châtelier's principle.
- C12-5-06** Solve problems involving  $pH$ .
- C12-5-07** Distinguish between strong and weak acids and bases.  
Include: electrolytes and non-electrolytes
- C12-5-08** Write the equilibrium expression ( $K_a$  or  $K_b$ ) from a balanced chemical equation.
- C12-5-09** Use  $K_a$  or  $K_b$  to solve problems for  $pH$ , percent dissociation, and concentration.
- C12-5-10** Perform a laboratory activity to determine the concentration of an unknown acid or base, using a standardized acid or base.
- C12-5-11** Predict whether an aqueous solution of a given ionic compound will be acidic, basic, or neutral, given the formula.
-

**Topic 6: Electrochemistry**

- C12-6-01** Develop an activity series experimentally.
- C12-6-02** Predict the spontaneity of reactions using an activity series.
- C12-6-03** Outline the historical development of voltaic (galvanic) cells.  
Include: contributions of Luigi Galvani and Alessandro Volta
- C12-6-04** Explain the operation of a voltaic (galvanic) cell at the visual, particulate, and symbolic levels.  
Include: writing half-cell reactions, the overall reaction, and shorthand (line) notation
- C12-6-05** Construct a functioning voltaic (galvanic) cell and measure its potential.
- C12-6-06** Define *standard electrode potential*.  
Include: hydrogen electrode as a reference
- C12-6-07** Calculate standard cell potentials, given standard electrode potentials.
- C12-6-08** Predict the spontaneity of reactions using standard electrode potentials.
- C12-6-09** Compare and contrast voltaic (galvanic) and electrolytic cells.
- C12-6-10** Explain the operation of an electrolytic cell at the visual, particulate, and symbolic levels.  
Include: a molten ionic compound and an aqueous ionic compound
- C12-6-11** Describe practical uses of electrolytic cells.  
*Examples: electrolysis of water, electrolysis of brine, electroplating, production and purification of metals . . .*
- C12-6-12** Using Faraday's law, solve problems related to electrolytic cells.
-

## NOTES

# GRADE 12 CHEMISTRY

---

Topic 1: Reactions in Aqueous Solutions

Topic 2: Atomic Structure

Topic 3: Chemical Kinetics

Topic 4: Chemical Equilibrium

Topic 5: Acids and Bases

Topic 6: Electrochemistry





**TOPIC 1:**  
**Reactions in AQUEOUS SOLUTIONS**

---



## Topic 1: Reactions in Aqueous Solutions

- C12-1-01** Explain examples of solubility and precipitation at the particulate and symbolic levels.
- C12-1-02** Perform a laboratory activity to develop a set of solubility rules.
- C12-1-03** Use a table of solubility rules to predict the formation of a precipitate.
- C12-1-04** Write balanced neutralization reactions involving strong acids and bases.
- C12-1-05** Perform a laboratory activity to demonstrate the stoichiometry of a neutralization reaction between a strong base and a strong acid.
- C12-1-06** Calculate the concentration or volume of an acid or a base from the concentration and volume of an acid or a base required for neutralization.
- C12-1-07** Design and test a procedure to determine the identity of a variety of unknown solutions.
- C12-1-08** Outline the development of scientific understanding of oxidation and reduction reactions.  
Include: gain and loss of electrons, oxidizing agent, and reducing agent
- C12-1-09** Determine the oxidation numbers for atoms in compounds and ions.
- C12-1-10** Identify reactions as redox or non-redox.  
Include: oxidizing agent, reducing agent, oxidized substance, and reduced substance
- C12-1-11** Balance oxidation-reduction reactions using redox methods.  
Include: acidic and basic solutions
- C12-1-12** Research practical applications of redox reactions.  
*Examples: rocket fuels, fireworks, household bleach, photography, metal recovery from ores, steel making, aluminum recycling, fuel cells, batteries, tarnish removal, fruit clocks, forensic blood detection using luminol, chemiluminescence/bioluminescence, electrolytic cleaning, electrodeposition, photochemical etching, antioxidants/preservatives . . .*

**Suggested Time: 18 hours**

**Topic 1:**  
**Reactions in**  
**Aqueous Solutions**

## SPECIFIC LEARNING OUTCOME

C12-1-01: Explain examples of solubility and precipitation at the particulate and symbolic levels.

(0.5 hour)

SLO: C12-1-01

## SUGGESTIONS FOR INSTRUCTION

## Entry-Level Knowledge

The solution process was addressed in detail in Grade 11 Chemistry (Topic 4: Solutions). Students explained the solution process of simple ionic and covalent compounds, using visual and particulate representations and chemical equations. Students performed a laboratory activity to illustrate the formation of solutions in terms of the polar and non-polar nature of substances, which included the terms *soluble* and *insoluble*.

## Assessing Prior Knowledge

Check for students' understanding of prior knowledge, and review concepts as necessary. Prior knowledge can be reviewed and/or assessed by using any of the KWL (Know, Want to Know, Learned) strategies (e.g., Concept Map, Knowledge Chart, Think-Pair-Share) found in Chapter 9 of *Senior Years Science Teachers' Handbook* (Manitoba Education and Training) – hereinafter referred to as *SYSTH*.

## TEACHER NOTES

## Demonstration

Provide students with several examples of solutions and have them explain the solution process at the molecular level and the symbolic level. In this context, the term *molecular* is considered interchangeable with the term *particulate*.

Example 1:  $\text{NaCl}_{(s)}$  dissolved in water

■ **Molecular level:**

$\text{NaCl}_{(s)} + \text{H}_2\text{O}_{(l)}$

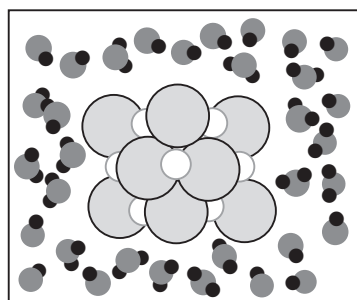

$\text{NaCl}_{(aq)}$

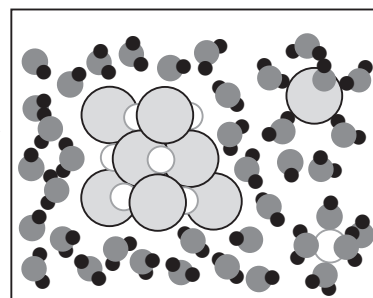

## General Learning Outcome Connections

**GLO D3:** Understand the properties and structures of matter, as well as various common manifestations and applications of the actions and interactions of matter.

**SKILLS AND ATTITUDES OUTCOME**

**C12-0-U1:** Use appropriate strategies and skills to develop an understanding of chemical concepts.

*Examples: analogies, concept frames, concept maps, manipulatives, particulate representations, role-plays, simulations, sort-and-predict frames, word cycles . . .*

- **Symbolic level:**

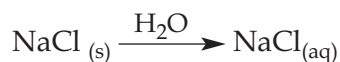

*Example 2:*  $\text{NaCl}_{(aq)}$  and  $\text{AgNO}_{3(aq)}$  combined together

- **Molecular level:**

First show both solutions individually in their beakers. In beaker 1,  $\text{NaCl}_{(aq)}$  is drawn with the  $\text{Na}^+$  and  $\text{Cl}^-$  ions circulating amidst the water molecules. In beaker 2,  $\text{AgNO}_{3(aq)}$  is drawn with the  $\text{Ag}^+$  and  $\text{NO}_3^-$  ions floating around the water molecules.

Then, in the third diagram, show the mixing of the two solutions. Students should see that the  $\text{Ag}^+$  ions will precipitate with the  $\text{Cl}^-$  ions, forming a white precipitate.

- **Symbolic level:**

Molecular equation:

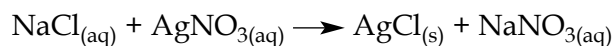

Ionic equation:

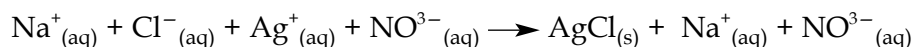

Net ionic equation:

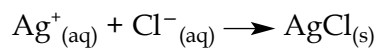
**Animations**

Have students view animations of precipitation reactions online.

*Sample Website:*

Virtual Crezlab Qualitative Analysis. "Precipitation Reactions: Another Example of Precipitation Reaction." *Teaching Laboratory*. Crescent Girls' School.

<[www.crescent.edu.sg/crezlab/webpages/pptReaction4.htm](http://www.crescent.edu.sg/crezlab/webpages/pptReaction4.htm)> (18 Jan. 2012).

This animation shows the reaction that takes place between solutions of sodium chloride and silver nitrate.

**Note:** Not all mixtures of ions produce a precipitation reaction. For example, if we mix together a solution of sodium chloride ( $\text{NaCl}$ ) and a solution of potassium iodide ( $\text{KI}$ ), no precipitation will occur. All ions will stay in the solution.

**Topic 1:  
Reactions in  
Aqueous Solutions**

---

**SPECIFIC LEARNING OUTCOME**

**C12-1-01:** Explain examples of solubility and precipitation at the particulate and symbolic levels.

(continued)

---

**SUGGESTIONS FOR ASSESSMENT**

---

**Paper-and-Pencil Task**

Ask students to diagram various reactions, showing the reaction at the molecular (particulate) level and at the symbolic level.

---

**LEARNING RESOURCES LINKS**

---



*Chemistry* (Chang 489)

*Chemistry* (Zumdahl and Zumdahl 133)

*Chemistry: The Molecular Nature of Matter and Change* (Silberberg 136)

*Glencoe Chemistry: Matter and Change* (Dingrando, et al. 455)

*McGraw-Hill Ryerson Inquiry into Chemistry* (Chastko, et al. 169)

*Prentice Hall Chemistry* (Wilbraham, et al. 488)

**Website**

Virtual Crezlab Qualitative Analysis. "Precipitation Reactions: Another Example of Precipitation Reaction." *Teaching Laboratory*. Crescent Girls' School. <[www.crescent.edu.sg/crezlab/webpages/pptReaction4.htm](http://www.crescent.edu.sg/crezlab/webpages/pptReaction4.htm)> (18 Jan. 2012).

**Selecting Learning Resources**

For additional information on selecting learning resources for Grade 11 and Grade 12 Chemistry, see the Manitoba Education website at <[www.edu.gov.mb.ca/k12/learnres/bibliographies.html](http://www.edu.gov.mb.ca/k12/learnres/bibliographies.html)>.

**SKILLS AND ATTITUDES OUTCOME**

**C12-0-U1:** Use appropriate strategies and skills to develop an understanding of chemical concepts.

*Examples: analogies, concept frames, concept maps, manipulatives, particulate representations, role-plays, simulations, sort-and-predict frames, word cycles . . .*

---

**NOTES**

**Topic 1:  
Reactions in  
Aqueous Solutions****SPECIFIC LEARNING OUTCOME****C12-1-02:** Perform a laboratory activity to develop a set of solubility rules.

(2 hours)

SLO: C12-1-02

**SUGGESTIONS FOR INSTRUCTION****Entry-Level Knowledge**

In Grade 9 Science (specific learning outcome S1-2-13), students defined the term *precipitate* and recognized the formation of a precipitate to be one of the indicators of a chemical change.

In Grade 10 Science (S2-2-07), students investigated double displacement reactions. Grade 11 Chemistry (Unit 4: Solutions) presented the concepts of species being soluble or insoluble. Concentration was also addressed in detail in Grade 11 Chemistry.

**Assessing Prior Knowledge**

Check for students' understanding of prior knowledge and review concepts as necessary. Prior knowledge can be reviewed and/or assessed by using any of the KWL strategies (e.g., Concept Map, Knowledge Chart, Think-Pair-Share – see *SYSTH*, Chapter 9).

**TEACHER NOTES**

The following demonstration is meant to be an activation activity. Students will be able to review reactions they have studied in Grade 10 Science and in Grade 11 Chemistry. Encourage students to draw molecular representations of these reactions.

**General Learning Outcome Connections**

- GLO B3:** Identify the factors that affect health, and explain the relationships among personal habits, lifestyle choices, and human health, both individual and social.
- GLO B5:** Identify and demonstrate actions that promote a sustainable environment, society, and economy, both locally and globally.
- GLO C1:** Recognize safety symbols and practices related to scientific and technological activities and to their daily lives, and apply this knowledge in appropriate situations.
- GLO C2:** Demonstrate appropriate scientific inquiry skills when seeking answers to questions.
- GLO C5:** Demonstrate curiosity, skepticism, creativity, open-mindedness, accuracy, precision, honesty, and persistence, and appreciate their importance as scientific and technological habits of mind.
- GLO C8:** Evaluate, from a scientific perspective, information and ideas encountered during investigations and in daily life.



**SKILLS AND ATTITUDES OUTCOMES**

- C12-0-S1:** Demonstrate work habits that ensure personal safety and the safety of others, as well as consideration for the environment.  
Include: knowledge and use of relevant safety precautions, Workplace Hazardous Materials Information System (WHMIS), and emergency equipment
- C12-0-S3:** Design and implement an investigation to answer a specific scientific question.  
Include: materials, independent and dependent variables, controls, methods, and safety considerations
- C12-0-S5:** Collect, record, organize, and display data using an appropriate format.  
*Examples: labelled diagrams, graphs, multimedia applications, software integration, probeware . . .*
- C12-0-S7:** Interpret patterns and trends in data, and infer and explain relationships.
- C12-0-S9:** Draw a conclusion based on the analysis and interpretation of data.  
Include: cause-and-effect relationships, alternative explanations, and supporting or rejecting a hypothesis or prediction
- C12-0-A1:** Demonstrate confidence in their ability to carry out investigations in chemistry and to address STSE-related issues.
- 

**Demonstration**

Show students the reaction between potassium iodide and lead(II) nitrate, or between cobalt(II) chloride and a saturated calcium hydroxide solution (limewater). These double displacement reactions demonstrate two indicators of a chemical change (colour and precipitate formation). As an extension, have students predict the products of the reaction and balance the equation. Remind students that both solutions have a concentration, which is a numeric reflection of the moles of solute compared to the volume of solution. The precipitate produced by the reaction is insoluble, or slightly soluble, in the other aqueous product.

**Laboratory Activity**

Have students develop their own procedure to create a set of solubility rules. For this experiment, see Appendix 1.1A: Developing a Set of Solubility Rules: Lab Activity. Provide students with 0.1 mol/L solutions of various anions and cations so that they can observe whether precipitates are formed. These observations will help students develop a set of solubility rules for the positive and negative ions used in the lab activity. A list of the solubility rules can be found in Appendix 1.1B: Developing a Set of Solubility Rules: Lab Activity (Teacher Notes) and in the resources listed in the Learning Resources Links.

**SUGGESTIONS FOR ASSESSMENT**

---

**Laboratory Report**

The lab activity could be assessed as a formal lab report using the Laboratory Report Outline or the Laboratory Report Format (see SYSTH 11.38, 14.12). Word processing and spreadsheet software could be used to prepare reports. Also refer to the Lab Report Assessment rubric in Appendix 11.

**Topic 1:  
Reactions in  
Aqueous Solutions**

---

**SPECIFIC LEARNING OUTCOME**

**C12-1-02:** Perform a laboratory activity to develop a set of solubility rules.

(continued)

**Laboratory Skills**

Periodically and randomly review the lab skills of individual students, so that eventually all students are assessed. Sample checklists for assessing lab skills and work habits are available in *SYSTH* (6.10, 6.11).

**Paper-and-Pencil Task**

Students can report on why certain ions are insoluble or soluble.

**Journal Writing**

Have students answer the following question in their science journals:

Do you think that “solubility guidelines” might be a better phrase to use than “solubility rules”? Why or why not?

**Class Discussion**

Students can share their results with each other and come up with some general guidelines regarding the solubility of ions in solution. The students’ rules can then be reconfirmed by the solubility rules table.

**LEARNING RESOURCES LINKS**

---



*Chemistry* (Chang 118)

*Chemistry* (Zumdahl and Zumdahl 150)

*Chemistry: The Molecular Nature of Matter and Change* (Silberberg 142)

*Glencoe Chemistry: Matter and Change* (Dingrando, et al. 920)

*McGraw-Hill Ryerson Inquiry into Chemistry* (Chastko, et al. 161)

*Nelson Chemistry 12: College Preparation Teacher’s Resource* (Penrose, et al.)  
LSM 1.15–1: The Solubility Rules, 97

*Prentice Hall Chemistry* (Wilbraham, et al. 344)

**Investigations**

*Laboratory Manual for Chemistry: Experiments and Principles* (Davis, et al.)  
Experiment 17: Reactions between Ions in Aqueous Solutions, 50

*Microscale Chemistry Laboratory Manual* (Slater and Rayner-Canham)  
Experiment 20: Solubilities of Salts, 60

*Prentice Hall Chemistry: The Study of Matter, Laboratory Manual* (Wagner)  
Lab 31: Precipitates and Solubility Rules, 157

**SKILLS AND ATTITUDES OUTCOMES**

**C12-0-S1:** Demonstrate work habits that ensure personal safety and the safety of others, as well as consideration for the environment.

Include: knowledge and use of relevant safety precautions, Workplace Hazardous Materials Information System (WHMIS), and emergency equipment

**C12-0-S3:** Design and implement an investigation to answer a specific scientific question.

Include: materials, independent and dependent variables, controls, methods, and safety considerations

**C12-0-S5:** Collect, record, organize, and display data using an appropriate format.

*Examples: labelled diagrams, graphs, multimedia applications, software integration, probeware . . .*

**C12-0-S7:** Interpret patterns and trends in data, and infer and explain relationships.

**C12-0-S9:** Draw a conclusion based on the analysis and interpretation of data.

Include: cause-and-effect relationships, alternative explanations, and supporting or rejecting a hypothesis or prediction

**C12-0-A1:** Demonstrate confidence in their ability to carry out investigations in chemistry and to address STSE-related issues.

---

**Appendices**

Appendix 1.1A: Developing a Set of Solubility Rules: Lab Activity

Appendix 1.1B: Developing a Set of Solubility Rules: Lab Activity  
(Teacher Notes)

**Selecting Learning Resources**

For additional information on selecting learning resources for Grade 11 and Grade 12 Chemistry, see the Manitoba Education website at <[www.edu.gov.mb.ca/k12/learnres/bibliographies.html](http://www.edu.gov.mb.ca/k12/learnres/bibliographies.html)>.

**Topic 1:  
Reactions in  
Aqueous Solutions****SPECIFIC LEARNING OUTCOME****C12-1-03:** Use a table of solubility rules to predict the formation of a precipitate.**(1 hour)**

SLO: C12-1-03

**SUGGESTIONS FOR INSTRUCTION****Entry-Level Knowledge**

In Grade 11 Chemistry (C11-4-03), students were introduced to the fact that when ionic compounds are placed in water, they dissociate (i.e., they separate into their ions). In Grade 10 Science (SLO S2-2-07), students classified reactions such as double displacement reactions. When solutions of two ionic compounds are placed into water, the ions will interact with each other and a double displacement reaction may occur. A precipitation reaction occurs when two aqueous solutions are mixed and a solid (precipitate) is formed. Refer to specific learning outcome C12-1-01 in Topic 1: Reactions in Aqueous Solutions, which addresses the process of double displacement reactions at the particulate level and the symbolic level.

**TEACHER NOTES**

Precipitation reactions are used in water treatment plants, in qualitative analysis, and as a preparation method for many salts. They are also a means by which limestone caverns are formed.

**Writing Net Ionic Equations**

Take students through the following steps to ensure that they will be able to write net ionic equations.

**General Learning Outcome Connections**

- GLO B3:** Identify the factors that affect health, and explain the relationships among personal habits, lifestyle choices, and human health, both individual and social.
- GLO B5:** Identify and demonstrate actions that promote a sustainable environment, society, and economy, both locally and globally.
- GLO C1:** Recognize safety symbols and practices related to scientific and technological activities and to their daily lives, and apply this knowledge in appropriate situations.
- GLO C2:** Demonstrate appropriate scientific inquiry skills when seeking answers to questions.
- GLO C5:** Demonstrate curiosity, skepticism, creativity, open-mindedness, accuracy, precision, honesty, and persistence, and appreciate their importance as scientific and technological habits of mind.
- GLO C8:** Evaluate, from a scientific perspective, information and ideas encountered during investigations and in daily life.
- GLO D3:** Understand the properties and structures of matter, as well as various common manifestations and applications of the actions and interactions of matter.

**SKILLS AND ATTITUDES OUTCOMES**

**C12-0-U1:** Use appropriate strategies and skills to develop an understanding of chemical concepts.

*Examples: analogies, concept frames, concept maps, manipulatives, particulate representations, role-plays, simulations, sort-and-predict frames, word cycles . . .*

**C12-0-U2:** Demonstrate an understanding of chemical concepts.

*Examples: use accurate scientific vocabulary, explain concepts to others, compare and contrast concepts, apply knowledge to new situations and/or contexts, create analogies, use manipulatives . . .*

**C12-0-S1:** Demonstrate work habits that ensure personal safety and the safety of others, as well as consideration for the environment.

Include: knowledge and use of relevant safety precautions, Workplace Hazardous Materials Information System (WHMIS), and emergency equipment

**C12-0-S9:** Draw a conclusion based on the analysis and interpretation of data.

Include: cause-and-effect relationships, alternative explanations, and supporting or rejecting a hypothesis or prediction

*Sample Problem:*

Write a net ionic equation for the reaction between  $\text{BaCl}_2$  and  $\text{Na}_2\text{SO}_4$ .

- Predict the products of the reaction and ensure that the equation is balanced.

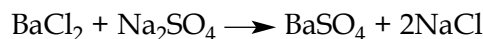

- Use Appendix 1.2: Solubility Rules to identify which ionic substances will precipitate from aqueous solutions. (Any chemistry text listed in the Learning Resources Links will have a table of rules.) Looking at these solubility rules, students should notice that the  $\text{Cl}^-$  ion is soluble with the  $\text{Na}^+$  ion. Therefore,  $\text{NaCl}$  will stay in solution; that is, it is written as  $\text{NaCl}_{(\text{aq})}$ . Students should also notice from the solubility rules that the  $\text{Ba}^{2+}$  ion forms an insoluble product with the  $\text{SO}_4^{2-}$  ion. Therefore,  $\text{BaSO}_4$  is written with a subscript  $_{(\text{s})}$ , as it forms a precipitate in the beaker. Those substances that form a precipitate should be followed by  $_{(\text{s})}$ , and those that do not form a precipitate should be followed by  $_{(\text{aq})}$ .

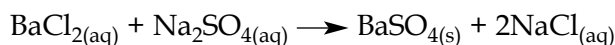

This is known as the *balanced molecular equation*.

- Recognize that soluble aqueous ionic compounds will dissociate into ions, whereas insoluble compounds will not. Students must make sure that their equation is balanced.

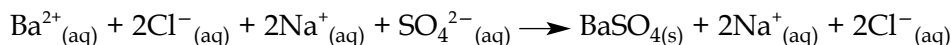

This is known as the *complete ionic equation, total ionic equation, or ionic equation*.

- Cancel out all spectator ions (those that appear on both sides of the equation), and rewrite the equation.

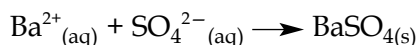
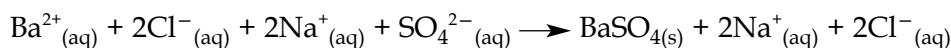

This is known as the *net ionic equation*.

See Appendix 1.3: Predicting Precipitation Reactions for more sample problems.

**Topic 1:  
Reactions in  
Aqueous Solutions**

---

**SPECIFIC LEARNING OUTCOME****C12-1-03:** Use a table of solubility rules to predict the formation of a precipitate.*(continued)***Animations**

A variety of animations of precipitation reactions are available online.

*Sample Websites:*

The North Carolina School of Science and Mathematics (NCSSM). Distance Education and Extended Programs. "Science Secondary Level." *STEM@NCSSM*. <[www.dlt.ncssm.edu/stem/sci-secondary](http://www.dlt.ncssm.edu/stem/sci-secondary)> (3 Aug. 2012).

Dozens of chemistry animations, images, documents, and videos can be found on this website.

\_\_\_\_\_. \_\_\_\_\_. "Chemistry Graphics – Moles." *Teacher's Instructional Graphics and Educational Resource (TIGER)*. <[www.dlt.ncssm.edu/stem/sci-secondary](http://www.dlt.ncssm.edu/stem/sci-secondary)> (18 Jan. 2012).

The animation entitled "DoubleDisp\_Reaction\_Precipitation.html (.exe or .mov)" shows the double displacement reaction between lead(II) nitrate and potassium iodide to form a slightly soluble precipitate.

Virtual Crezlab Qualitative Analysis. "Precipitation Reactions: Precipitation Explained." *Teaching Laboratory*. Crescent Girls' School. <[www.crescent.edu.sg/crezlab/webpages/pptReaction3.htm](http://www.crescent.edu.sg/crezlab/webpages/pptReaction3.htm)> (18 Jan. 2012).

This animation shows the precipitation reaction of lead(II) nitrate and potassium iodide.

**Laboratory Activity**

Provide students with well plates and four unknown solutions in dropper bottles. Students should be able to determine the identity of each solution, using experimentation, their solubility rules, and a colour chart (see Appendix 1.4: Colour Chart for Ions in Aqueous Solutions). For a sample procedure, see Appendix 1.5: Identifying Unknown Solutions (Teacher Notes and Preparation Guide).

**Discrepant Event**

If you have not already done the demonstration suggested for C12-1-01, show students that two clear solutions mixed together do not necessarily give a clear product (e.g., lead(II) nitrate and potassium iodide).

Alternatively, for a more environmentally friendly demonstration, show students a precipitation reaction with a variety of colours involved.

**SKILLS AND ATTITUDES OUTCOMES**

**C12-0-U1:** Use appropriate strategies and skills to develop an understanding of chemical concepts.

*Examples: analogies, concept frames, concept maps, manipulatives, particulate representations, role-plays, simulations, sort-and-predict frames, word cycles . . .*

**C12-0-U2:** Demonstrate an understanding of chemical concepts.

*Examples: use accurate scientific vocabulary, explain concepts to others, compare and contrast concepts, apply knowledge to new situations and/or contexts, create analogies, use manipulatives . . .*

**C12-0-S1:** Demonstrate work habits that ensure personal safety and the safety of others, as well as consideration for the environment.

Include: knowledge and use of relevant safety precautions, Workplace Hazardous Materials Information System (WHMIS), and emergency equipment

**C12-0-S9:** Draw a conclusion based on the analysis and interpretation of data.

Include: cause-and-effect relationships, alternative explanations, and supporting or rejecting a hypothesis or prediction

---

*Example:*

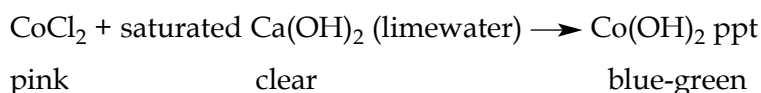
**SUGGESTIONS FOR ASSESSMENT**

---

**Paper-and-Pencil Task**

Have students use process notes to solve problems using a set of solubility rules to predict the potential formation of a precipitate in a double replacement reaction. For examples of problems, see Appendix 1.3: Predicting Precipitation Reactions.

**Laboratory Skills**

Periodically and randomly review the lab skills of individual students, so that eventually all students are assessed. Sample checklists for assessing lab skills and work habits are available in *SYSTH* (6.10, 6.11).

**Journal Writing/Process Notes**

Students can explain the steps to writing out net ionic equations in their science journals. See Appendix 1.6A: Process Notes for Writing Net Ionic Equations (Teacher Notes) and Appendix 1.6B: Process Notes for Writing Net Ionic Equations (BLM).

**Visual Displays**

Have students create a Word Cycle using the terms *ions*, *spectator ions*, *precipitate*, *molecular equation*, *total ionic equation*, *net ionic equation*, and *double displacement reaction* (see Word Cycle, *SYSTH* 10.21).

**Topic 1:  
Reactions in  
Aqueous Solutions**

**SPECIFIC LEARNING OUTCOME**

**C12-1-03:** Use a table of solubility rules to predict the formation of a precipitate.

(continued)

**LEARNING RESOURCES LINKS**



*Chemistry* (Chang 118)

*Chemistry* (Zumdahl and Zumdahl 150)

*Chemistry: The Molecular Nature of Matter and Change* (Silberberg 142)

*Glencoe Chemistry: Concepts and Applications* (Phillips, Strozak, and Wistrom)  
ChemLab Solution Identification, 456

*Glencoe Chemistry: Matter and Change* (Dingrando, et al. 290)

*McGraw-Hill Ryerson Chemistry, Combined Atlantic Edition* (Mustoe, et al. 289)

*McGraw-Hill Ryerson Inquiry into Chemistry* (Chastko, et al. 161)

*Nelson Chemistry 12: College Preparation Teacher's Resource* (Penrose, et al.)  
LSM 1.15-1: The Solubility Rules, 97

*Nelson Chemistry 12: College Preparation, Ontario Edition* (Davies, et al.)  
Using Solubility Rules to Predict Precipitate Formation, 54

*Prentice Hall Chemistry* (Wilbraham, et al. 344)

**Investigations**

*Glencoe Chemistry: Matter and Change* (Dingrando, et al.)  
MiniLab: Observing a Precipitate-Forming Reaction, 295

*McGraw-Hill Ryerson Chemistry, Combined Atlantic Edition* (Mustoe, et al.)  
Investigation 8-A: The Solubility of Ionic Compounds, 283

*Prentice Hall Chemistry Today: Laboratory Manual* (Whitman and Zinck)  
Solutions and Solubility, 58

**Websites**

The North Carolina School of Science and Mathematics (NCSSM). Distance Education and Extended Programs. "Science Secondary Level." *STEM@NCSSM*. <[www.dlt.ncssm.edu/stem/sci-secondary](http://www.dlt.ncssm.edu/stem/sci-secondary)> (3 Aug. 2012).

\_\_\_\_\_. \_\_\_\_\_. "Chemistry Graphics – Moles." *Teacher's Instructional Graphics and Educational Resource (TIGER)*. <[www.dlt.ncssm.edu/tiger/chem2.htm#moles](http://www.dlt.ncssm.edu/tiger/chem2.htm#moles)> (18 Jan. 2012).

Virtual Crezlab Qualitative Analysis. "Precipitation Reactions: Precipitation Explained." *Teaching Laboratory*. Crescent Girls' School. <[www.crescent.edu.sg/crezlab/webpages/pptReaction3.htm](http://www.crescent.edu.sg/crezlab/webpages/pptReaction3.htm)> (18 Jan. 2012).



**SKILLS AND ATTITUDES OUTCOMES**

**C12-0-U1:** Use appropriate strategies and skills to develop an understanding of chemical concepts.

*Examples: analogies, concept frames, concept maps, manipulatives, particulate representations, role-plays, simulations, sort-and-predict frames, word cycles . . .*

**C12-0-U2:** Demonstrate an understanding of chemical concepts.

*Examples: use accurate scientific vocabulary, explain concepts to others, compare and contrast concepts, apply knowledge to new situations and/or contexts, create analogies, use manipulatives . . .*

**C12-0-S1:** Demonstrate work habits that ensure personal safety and the safety of others, as well as consideration for the environment.

Include: knowledge and use of relevant safety precautions, Workplace Hazardous Materials Information System (WHMIS), and emergency equipment

**C12-0-S9:** Draw a conclusion based on the analysis and interpretation of data.

Include: cause-and-effect relationships, alternative explanations, and supporting or rejecting a hypothesis or prediction

---

**Appendices**

Appendix 1.2: Solubility Rules

Appendix 1.3: Predicting Precipitation Reactions

Appendix 1.4: Colour Chart for Ions in Aqueous Solutions

Appendix 1.5: Identifying Unknown Solutions (Teacher Notes and Preparation Guide)

Appendix 1.6A: Process Notes for Writing Net Ionic Equations (Teacher Notes)

Appendix 1.6B: Process Notes for Writing Net Ionic Equations (BLM)

**Selecting Learning Resources**

For additional information on selecting learning resources for Grade 11 and Grade 12 Chemistry, see the Manitoba Education website at <[www.edu.gov.mb.ca/k12/learnres/bibliographies.html](http://www.edu.gov.mb.ca/k12/learnres/bibliographies.html)>.

**Topic 1:**  
**Reactions in**  
**Aqueous Solutions**

**SPECIFIC LEARNING OUTCOMES**

- C12-1-04:** Write balanced neutralization reactions involving strong acids and bases.
- C12-1-05:** Perform a laboratory activity to demonstrate the stoichiometry of a neutralization reaction between a strong base and a strong acid.

(2.5 hours)

SLO: C12-1-04  
SLO: C12-1-05

**SUGGESTIONS FOR INSTRUCTION****Entry-Level Knowledge**

The following learning outcomes were addressed in Grade 10 Science:

- S2-2-03:** Write formulas and names of binary ionic compounds.  
Include: IUPAC guidelines and rationale for their use
- S2-2-06:** Balance chemical equations.  
Include: translation of word equations to balanced chemical equations, and balanced chemical equations to word equations
- S2-2-10:** Explain how acids and bases interact to form a salt and water in the process of neutralization.

In Grade 11 Chemistry (C11-3-03), students were shown how to write formulas and names for polyatomic compounds using International Union of Pure and Applied Chemistry (IUPAC) nomenclature.

**Assessing Prior Knowledge**

Check for students' prior knowledge and review concepts as necessary.

**TEACHER NOTES****Rules for Naming Binary and Polyatomic Acids**

Introduce the rules for naming binary and polyatomic acids.

To name binary acids, follow these steps:

1. Use the prefix *hydro-*.
2. Use the root of the anion.
3. Use the suffix *-ic*.
4. Use the word *acid* as the second word in the name.

**General Learning Outcome Connections**

- GLO C2:** Demonstrate appropriate scientific inquiry skills when seeking answers to questions.
- GLO C5:** Demonstrate curiosity, skepticism, creativity, open-mindedness, accuracy, precision, honesty, and persistence, and appreciate their importance as scientific and technological habits of mind.
- GLO D3:** Understand the properties and structures of matter, as well as various common manifestations and applications of the actions and interactions of matter.

**SKILLS AND ATTITUDES OUTCOMES**

**C12-0-U1:** Use appropriate strategies and skills to develop an understanding of chemical concepts.

*Examples: analogies, concept frames, concept maps, manipulatives, particulate representations, role-plays, simulations, sort-and-predict frames, word cycles . . .*

**C12-0-U2:** Demonstrate an understanding of chemical concepts.

*Examples: use accurate scientific vocabulary, explain concepts to others, compare and contrast concepts, apply knowledge to new situations and/or contexts, create analogies, use manipulatives . . .*

**C12-0-S5:** Collect, record, organize, and display data using an appropriate format.

*Examples: labelled diagrams, graphs, multimedia applications, software integration, probeware . . .*

**C12-0-S8:** Evaluate data and data-collection methods for accuracy and precision.

*Include: discrepancies in data, sources of error, and percent error*

---

*Example 1:*

Naming a binary acid: HCl

1. hydro-
2. -chloride
3. -chloric
4. hydrochloric acid

To name polyatomic acids, follow a different set of rules. Many of the oxygen-rich polyatomic negative ions form acids that are named by replacing the suffix *-ate* with *-ic* and the suffix *-ite* with *-ous*. To name oxyacids (acids containing the element oxygen), students should be able to recognize oxyacids by the general formula  $H_aX_bO_c$ , where X represents an element other than hydrogen or oxygen. If enough  $H^+$  ions are added to a (root)ate polyatomic ion to completely neutralize its charge, the (root)ic acid is formed.

*Examples of polyatomic acids:*

$HNO_3$  (nitric acid) is formed by adding one  $H^+$  ion to nitrate,  $NO_3^-$

$H_2SO_4$  (sulphuric acid) is formed by adding two  $H^+$  ions to sulphate,  $SO_4^{2-}$

A *strong acid* completely dissociates into ions. This means that if 100 molecules of HCl are dissolved in water, 100 ions of  $H^+$  and 100 ions of  $Cl^-$  are produced.

Emphasize that there are only six strong acids: hydrochloric acid (HCl), hydrobromic acid (HBr), hydroiodic acid (HI), sulphuric acid ( $H_2SO_4$ ), nitric acid ( $HNO_3$ ), and perchloric acid ( $HClO_4$ ). Students should memorize the names of these acids, as this nomenclature forms the basis for naming other acids. Naming of other oxyacids and weak acids will be dealt with in Topic 5: Acids and Bases.

To name a base, the name of the metal is combined with the anion,  $OH^-$ , hydroxide ion. For example, NaOH would be named sodium hydroxide. A *strong base* completely dissociates into ions. This means that if 100 formula units of NaOH are dissolved in water, 100 ions of  $Na^+$  and 100 ions of  $OH^-$  are produced. Strong bases include any ionic compound that contains the hydroxide ( $OH^-$ ) ion. When combined with the hydroxide ion, elements found in groups 1 (IA) and 2 (IIA) form strong bases.

---

**Topic 1:**  
**Reactions in**  
**Aqueous Solutions**

**SPECIFIC LEARNING OUTCOMES**

**C12-1-04:** Write balanced neutralization reactions involving strong acids and bases.

**C12-1-05:** Perform a laboratory activity to demonstrate the stoichiometry of a neutralization reaction between a strong base and a strong acid.

(continued)

These are the only acids and bases that students will be dealing with in Topic 1: Reactions in Aqueous Solutions.

When a strong acid and a strong base combine together they react completely. This means that all the hydrogen ions (from the acid) and all the hydroxide ions (from the base) will react to form water.

Remind students that acids and bases are ionic compounds, so that when placed into water, they will separate into their ions and undergo a double displacement reaction where a salt and water are formed.

*Example 2:*

Write an equation for the neutralization reaction between  $\text{H}_2\text{SO}_4$  and  $\text{NaOH}$ .

- Predict the products of the reaction and ensure that the equation is balanced.

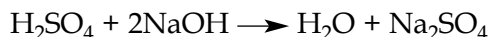

- Use the solubility rules to confirm whether each product will be aqueous, solid, or liquid.

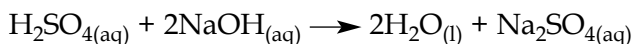

**Note:** Point out to students that water is a liquid, since aqueous solutions are dissolved in water.

- Write a total ionic equation, showing all ions that are in solution.

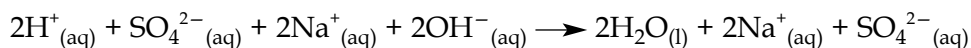

- Cancel the spectator ions and write the net ionic equation.

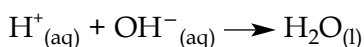
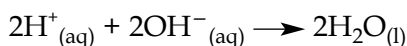
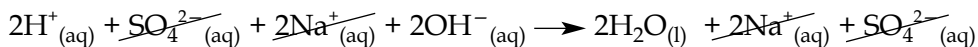

**SKILLS AND ATTITUDES OUTCOMES**

**C12-0-U1:** Use appropriate strategies and skills to develop an understanding of chemical concepts.

*Examples: analogies, concept frames, concept maps, manipulatives, particulate representations, role-plays, simulations, sort-and-predict frames, word cycles . . .*

**C12-0-U2:** Demonstrate an understanding of chemical concepts.

*Examples: use accurate scientific vocabulary, explain concepts to others, compare and contrast concepts, apply knowledge to new situations and/or contexts, create analogies, use manipulatives . . .*

**C12-0-S5:** Collect, record, organize, and display data using an appropriate format.

*Examples: labelled diagrams, graphs, multimedia applications, software integration, probeware . . .*

**C12-0-S8:** Evaluate data and data-collection methods for accuracy and precision.

*Include: discrepancies in data, sources of error, and percent error*

---

**Discrepant Event**

Show students that neutralization reactions can produce a greater volume than the sum of the volumes of the reactants. Traditional demonstrations include adding 125 mL of 0.1 mol/L HCl to 125 mL of 0.1 mol/L NaOH in a 250 mL graduated cylinder. An increase in volume of 2 to 3 mL should be observed. Have students explain this demonstration using particulate representations.

**Animations/Simulations**

Have students view online animations/simulations of neutralization reactions.

*Sample Websites:*

International Union of Pure and Applied Chemistry (IUPAC). Home Page.

[www.iupac.org](http://www.iupac.org) (18 Jan. 2012).

Virtual Crezlab Qualitative Analysis. "Acid-Base Reactions." *Teaching Laboratory*. Crescent Girls' School.

[www.crescent.edu.sg/crezlab/webpages/AcidReaction3.htm](http://www.crescent.edu.sg/crezlab/webpages/AcidReaction3.htm) (18 Jan. 2012).

This simulation demonstrates the neutralization reaction between sodium hydroxide and hydrogen chloride solutions. The spectator ions are also indicated in the simulation.

**TEACHER NOTES**

In Grade 10 Science, students worked with a 1:1 ratio for the neutralization reaction. In the following suggested lab activity, students will look at a 2:1 ratio. It is recommended that teachers avoid any discussion of Brønsted-Lowry acids and bases in addressing learning outcomes C12-1-04 and C12-1-05. A more in-depth titration will be done in Topic 5: Acids and Bases.

**Laboratory Activity**

Provide students with 0.1 mol/L solutions of NaOH and H<sub>2</sub>SO<sub>4</sub>. Have them perform a microscale titration so that they can compare the stoichiometric ratio to the experimental molar ratio between the reactants. Refer to Dispensing Drops from a Pipet onto a Reaction Surface (Waterman and Thompson 10). See Appendix 1.7A: Titration: Lab Activity and Appendix 1.7B: Titration: Lab Activity (Teacher Notes).

**Topic 1:  
Reactions in  
Aqueous Solutions**

---

**SPECIFIC LEARNING OUTCOMES**

**C12-1-04:** Write balanced neutralization reactions involving strong acids and bases.

**C12-1-05:** Perform a laboratory activity to demonstrate the stoichiometry of a neutralization reaction between a strong base and a strong acid.

(continued)

---

**SUGGESTIONS FOR ASSESSMENT**

---

**Process Notes**

Ask students to explain the steps involved in writing neutralization reactions using process notes. For an example, see Appendix 1.8: Process Notes for Balancing Neutralization Reactions.

**Paper-and-Pencil Task**

Students should be able to write balanced neutralization reactions.

**Laboratory Reports**

The lab activity could be assessed as a formal lab report using the Laboratory Report Outline or the Laboratory Report Format (see *SYSTH* 11.38, 14.12). Word processing and spreadsheet software could be used to prepare reports. Also refer to the Lab Report Assessment rubric in Appendix 11.

**Laboratory Skills**

Periodically and randomly review the lab skills of individual students, so that eventually all students are assessed. Assess skills such as ensuring consistent trials, proper use of a micropipette, and safe handling of chemicals. Sample checklists for assessing lab skills and work habits are available in *SYSTH* (6.10, 6.11).

**LEARNING RESOURCES LINKS**

---



*Chemistry* (Chang 125)

*Chemistry* (Zumdahl and Zumdahl 161)

*Chemistry: The Molecular Nature of Matter and Change* (Silberberg 144, 148)

*Glencoe Chemistry: Concepts and Applications* (Phillips, Strozak, and Wistrom 521)

*Glencoe Chemistry: Matter and Change* (Dingrando, et al. 250, 295, 617)

*McGraw-Hill Ryerson Inquiry into Chemistry* (Chastko, et al. 163, 224)

*Prentice Hall Chemistry* (Wilbraham, et al. 217, 612)

### SKILLS AND ATTITUDES OUTCOMES

**C12-0-U1:** Use appropriate strategies and skills to develop an understanding of chemical concepts.

*Examples: analogies, concept frames, concept maps, manipulatives, particulate representations, role-plays, simulations, sort-and-predict frames, word cycles . . .*

**C12-0-U2:** Demonstrate an understanding of chemical concepts.

*Examples: use accurate scientific vocabulary, explain concepts to others, compare and contrast concepts, apply knowledge to new situations and/or contexts, create analogies, use manipulatives . . .*

**C12-0-S5:** Collect, record, organize, and display data using an appropriate format.

*Examples: labelled diagrams, graphs, multimedia applications, software integration, probeware . . .*

**C12-0-S8:** Evaluate data and data-collection methods for accuracy and precision.

*Include: discrepancies in data, sources of error, and percent error*

---

### Investigations

*Microscale Chemistry Laboratory Manual (Slater and Rayner-Canham)  
Volumetric Acid-Base Titration, 24*

*Prentice Hall Chemistry: Small-Scale Chemistry Laboratory Manual  
(Waterman and Thompson)  
Dispensing Drops from a Pipet onto a Reaction Surface, 10*

### Websites

International Union of Pure and Applied Chemistry (IUPAC). Home Page.  
<[www.iupac.org](http://www.iupac.org)> (18 Jan. 2012).

Virtual Crezlab Qualitative Analysis. "Acid-Base Reactions." *Teaching Laboratory*. Crescent Girls' School.  
<[www.crescent.edu.sg/crezlab/webpages/AcidReaction3.htm](http://www.crescent.edu.sg/crezlab/webpages/AcidReaction3.htm)>  
(18 Jan. 2012).

### Appendices

Appendix 1.7A: Titration: Lab Activity

Appendix 1.7B: Titration: Lab Activity (Teacher Notes)

Appendix 1.8: Process Notes for Balancing Neutralization Reactions

#### Selecting Learning Resources

For additional information on selecting learning resources for Grade 11 and Grade 12 Chemistry, see the Manitoba Education website at <[www.edu.gov.mb.ca/k12/learnres/bibliographies.html](http://www.edu.gov.mb.ca/k12/learnres/bibliographies.html)>.

**Topic 1:**  
**Reactions in**  
**Aqueous Solutions**

**SPECIFIC LEARNING OUTCOME**

**C12-1-06:** Calculate the concentration or volume of an acid or a base from the concentration and volume of an acid or a base required for neutralization.

(1 hour)

SLO: C12-1-06

**SUGGESTIONS FOR INSTRUCTION****Entry-Level Knowledge**

In addressing learning outcome C12-1-05, students obtained experimental data related to the stoichiometry of a neutralization reaction between a strong base and a strong acid.

**Demonstrations/Activating Activity**

Before applying the suggested problem-solving strategy for sample neutralization problems, teachers can perform several acid-base demonstrations to activate students' interest. Have students write their observations on the chemical reaction taking place (i.e., first describe the reactants and then describe the resulting products).

The following list is a sample of the variety of demonstrations teachers can choose to perform. References for these demonstrations are given in the Learning Resources Links.

- **Orange Juice to Strawberry Float**

This demonstration involves mixing sodium bicarbonate and Alconox in water. Methyl orange indicator is added to this solution, which results in a solution similar to orange juice. Then hydrochloric acid is added quickly but very carefully. The reaction is very vigorous and produces a solution that looks like a strawberry float.

**Note:**

Because some of these demonstrations involve weak acids, students should not be asked to write balanced equations after they are shown.

**Caution:**

This is a very messy demonstration and strict safety precautions should be taken.

**General Learning Outcome Connections**

**GLO C2:** Demonstrate appropriate scientific inquiry skills when seeking answers to questions.

**GLO C5:** Demonstrate curiosity, skepticism, creativity, open-mindedness, accuracy, precision, honesty, and persistence, and appreciate their importance as scientific and technological habits of mind.

**GLO D3:** Understand the properties and structures of matter, as well as various common manifestations and applications of the actions and interactions of matter.



**SKILLS AND ATTITUDES OUTCOMES**

**C12-0-U1:** Use appropriate strategies and skills to develop an understanding of chemical concepts.

*Examples: analogies, concept frames, concept maps, manipulatives, particulate representations, role-plays, simulations, sort-and-predict frames, word cycles . . .*

**C12-0-S5:** Collect, record, organize, and display data using an appropriate format.

*Examples: labelled diagrams, graphs, multimedia applications, software integration, probeware . . .*

---

**■ pH Rainbow Tube**

This demonstration starts with a tube filled with green solution. At one end, a few drops of acid are added, and at the other end, a few drops of base are added. As a result, a whole spectrum of colours appears.

**■ Multi-Use for “MoM”**

For this demonstration, a mixture of magnesium hydroxide ( $\text{Mg}(\text{OH})_2$ ), also known as milk of magnesia, hydrochloric acid, and universal indicator shows a colour change from blue (basic) to red (acidic). The full colour range of universal indicator is shown during this process.

**■ Indicator Sponge**

This demonstration shows an indicator colour transition between pH 3 (blue) and pH 5 (red). Materials needed are a light-coloured cellulose sponge, a congo red indicator, sodium bicarbonate, and acetic or hydrochloric acid.

**■ Magic Pitcher Demo**

Several beakers are set up and, with the “magic pitcher,” students observe different colour changes in the beakers. The key to this demonstration is that all the beakers have had some drops of either acid or base, with varying concentrations, added to them.

**TEACHER NOTES**

Students can use the experimental data obtained in relation to learning outcome C12-1-04 to determine the unknown concentration of the acid or base. Teachers should de-emphasize the use of formulas such as  $C_1V_1 = C_2V_2$ . Also note that some chemistry texts use the following notation for concentration:  $M_1V_1 = M_2V_2$ . In American-based textbooks, it is common to see molarity (M) being used. In Grade 11 Chemistry (C11-4-13), the definition for *molarity* and *concentration* are given. Use mol/L as much as possible, as IUPAC no longer accepts M (molarity) as a unit. Refer to the following website for further information on correct terminology and units:

International Union of Pure and Applied Chemistry (IUPAC). Home Page.

<[www.iupac.org](http://www.iupac.org)> (18 Jan. 2012).

**Topic 1:**  
**Reactions in**  
**Aqueous Solutions**

**SPECIFIC LEARNING OUTCOME**

**C12-1-06:** Calculate the concentration or volume of an acid or a base from the concentration and volume of an acid or a base required for neutralization.

*(continued)***Problem-Solving Strategy**

To help students gain a better understanding of the concept of calculating the concentration or volume of an acid or a base, use the following process in solving neutralization problems:

1. Write a balanced chemical equation for the reaction.
2. Use the concentration and volume of the known acid or base to calculate the moles of the substance.
3. Use the coefficients from the balanced equation to determine the moles of the unknown acid or base.
4. Calculate the required volume or concentration of the acid or base.

**Sample Neutralization Problems**

1. In the reaction of 35.0 mL of liquid drain cleaner containing sodium hydroxide (NaOH), 50.08 mL of 0.409 mol/L hydrochloric acid (HCl) must be added to neutralize the base. What is the concentration of the base in the cleaner?

*Solution:*

- a) Write a balanced equation.

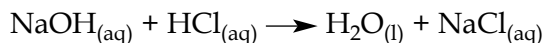

- b) Calculate the number of moles of HCl by multiplying concentration by volume.

$$\begin{aligned} \text{mol HCl} &= (0.409 \text{ mol/L})(0.05008 \text{ L}) \\ &= 0.0205 \text{ mol HCl} \end{aligned}$$

- c) Use the balanced equation for the mole ratio between HCl and NaOH, and solve for the number of moles of NaOH.

$$\begin{aligned} \frac{1 \text{ mol NaOH}}{1 \text{ mol HCl}} &= \frac{x \text{ mol NaOH}}{0.0205 \text{ mol HCl}} \\ x \text{ mol NaOH} &= 0.0205 \cancel{\text{ mol HCl}} \times \frac{1 \text{ mol NaOH}}{1 \cancel{\text{ mol HCl}}} \\ x \text{ mol NaOH} &= 0.0205 \text{ moles NaOH} \end{aligned}$$

- d) Solve for the concentration of NaOH by dividing the number of moles by the volume given.

$$[\text{NaOH}] = \frac{0.0205 \text{ moles}}{0.0350 \text{ L}} = 0.586 \text{ mol/L}$$

**SKILLS AND ATTITUDES OUTCOMES**

**C12-0-U1:** Use appropriate strategies and skills to develop an understanding of chemical concepts.

*Examples: analogies, concept frames, concept maps, manipulatives, particulate representations, role-plays, simulations, sort-and-predict frames, word cycles . . .*

**C12-0-S5:** Collect, record, organize, and display data using an appropriate format.

*Examples: labelled diagrams, graphs, multimedia applications, software integration, probeware . . .*

---

2. Calculate the volume of 0.256 mol/L Ba(OH)<sub>2</sub> that must be added to neutralize 46.0 mL of 0.407 mol/L HClO<sub>4</sub>.

*Solution:*

- a) Write a balanced equation.

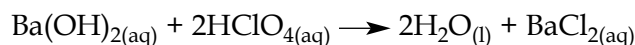

- b) Calculate the number of moles of HClO<sub>4</sub> by multiplying concentration by volume.

$$\begin{aligned} \text{mol HClO}_4 &= (0.407 \text{ mol/L})(0.0460 \text{ L}) \\ &= 0.0187 \text{ mol HClO}_4 \end{aligned}$$

- c) Solve for the number of moles of Ba(OH)<sub>2</sub> by setting up the ratio, number of moles: coefficient from balanced equation.

$$\frac{\text{mol HClO}_4}{\text{coefficient HClO}_4} = \frac{\text{mol Ba(OH)}_2}{\text{coefficient Ba(OH)}_2}$$

$$\frac{0.0187 \text{ mol HClO}_4}{2 \text{ mol HClO}_4} = \frac{\text{mol Ba(OH)}_2}{1 \text{ mol Ba(OH)}_2}$$

$$0.00935 \text{ mol Ba(OH)}_2 = \text{mol Ba(OH)}_2$$

- d) Solve for the volume of Ba(OH)<sub>2</sub> by dividing the number of moles by the concentration.

$$V = \frac{\text{mol}}{C} = \frac{0.00935 \text{ mol}}{0.256 \text{ mol/L}} = 0.0365 \text{ L}$$

$$\text{Volume of Ba(OH)}_2 = 36.5 \text{ mL}$$

**SUGGESTIONS FOR ASSESSMENT**

---

**Paper-and-Pencil Tasks**

1. Ask students to write down the steps for solving neutralization problems.
2. Provide students with a neutralization problem to solve. Use a process-notes format to have individuals share their thought processes for finding the mathematical solution to the problems.

The texts cited in the Learning Resources Links provide samples of problems in calculating for the concentration or the volume of given solutions.

**Topic 1:  
Reactions in  
Aqueous Solutions**

**SPECIFIC LEARNING OUTCOME**

**C12-1-06:** Calculate the concentration or volume of an acid or a base from the concentration and volume of an acid or a base required for neutralization.

(continued)

**LEARNING RESOURCES LINKS**



*Chemistry* (Chang 145)

*Chemistry* (Zumdahl and Zumdahl 162)

*Chemistry: The Molecular Nature of Matter and Change* (Silberberg 147)

*Glencoe Chemistry: Concepts and Applications* (Phillips, Strozak, and Wistrom 521)

*Glencoe Chemistry: Matter and Change* (Dingrando, et al. 617)

*McGraw-Hill Ryerson Chemistry*, Combined Atlantic Edition (Mustoe, et al. 600)

*Prentice Hall Chemistry* (Wilbraham, et al. 612)

**Demonstrations**

Becker, Robert. "pH Rainbow Tube." *Chem 13 News* 190 (Dec. 1989).

\_\_\_\_\_. "pH Rainbow Tube." 1999. Flinn Scientific, Inc. Available on the Northern Kentucky University website at <[www.nku.edu/~sieveb1/makeandtake2011.pdf](http://www.nku.edu/~sieveb1/makeandtake2011.pdf)> (17 Apr. 2012).

Flinn Scientific, Inc. "Indicator Sponge: A Discrepant Event Demonstration." 2009. *Chem Fax!* <[www.flinnsci.com/Documents/demoPDFs/Chemistry/CF10376.pdf](http://www.flinnsci.com/Documents/demoPDFs/Chemistry/CF10376.pdf)> (18 May 2012).

\_\_\_\_\_. "Orange Juice to Strawberry Float: A Foamy Acid-Base Demonstration." 2010. *Chem Fax!* <[www.flinnsci.com/Documents/demoPDFs/Chemistry/CF0516.00.pdf](http://www.flinnsci.com/Documents/demoPDFs/Chemistry/CF0516.00.pdf)> (17 Apr. 2012).

\_\_\_\_\_. *Orange Juice to Strawberry Float*. 2009. YouTube. <[www.youtube.com/watch?v=UVdbG9-mHyc&feature=BFa&list=ULUVdbG9-mHyc&lf=channel](http://www.youtube.com/watch?v=UVdbG9-mHyc&feature=BFa&list=ULUVdbG9-mHyc&lf=channel)> (17 Apr. 2012).

Gross, George, et al. "Indicator Sponge." *A Demo a Day: A Year of Chemical Demonstrations*. Ed. Borislav Bilash II, George R. Gross, and John K. Koob. Batavia, IL: Flinn Scientific, Inc., 1995.

Tanis, Dave. *Demonstrations in Chemistry Classrooms*, Michigan Science Teachers Association Conference. 14 Mar. 2003. <<http://alittlecreation.com/science/Chemistry/tanis-chem.pdf>> (6 Aug. 2010).

This resource describes the following demonstrations:

- Sconzo, Penny. "Multi-Use for MOM." *Flinn Workshop Materials*. Batavia, IL: Flinn Scientific Foundation, 2001. Page 29.
- Becker, Bob. "Magic Pitcher Demo." *Flinn Workshop Materials*. Batavia, IL: Flinn Scientific, Inc., 2001. Page 54.

**SKILLS AND ATTITUDES OUTCOMES**

**C12-0-U1:** Use appropriate strategies and skills to develop an understanding of chemical concepts.

*Examples: analogies, concept frames, concept maps, manipulatives, particulate representations, role-plays, simulations, sort-and-predict frames, word cycles . . .*

**C12-0-S5:** Collect, record, organize, and display data using an appropriate format.

*Examples: labelled diagrams, graphs, multimedia applications, software integration, probeware . . .*

---

**Selecting Learning Resources**

For additional information on selecting learning resources for Grade 11 and Grade 12 Chemistry, see the Manitoba Education website at <[www.edu.gov.mb.ca/k12/learnres/bibliographies.html](http://www.edu.gov.mb.ca/k12/learnres/bibliographies.html)>.

**Topic 1:  
Reactions in  
Aqueous Solutions****SPECIFIC LEARNING OUTCOME****C12-1-07:** Design and test a procedure to determine the identity of a variety of unknown solutions.**(2 hours)**

SLO: C12-1-07

**SUGGESTIONS FOR INSTRUCTION****Entry-Level Knowledge**

Students should be able to use the concepts addressed in the previous learning outcomes to proceed with the lab activity that follows.

**TEACHER NOTES**

The solutions for the following lab activity should be prepared well in advance of the actual lab period. Hand out the lab guidelines a week before students perform the lab activity so they can research the possible products for each reaction (see Appendix 1.9A: Test Tube Mystery: Lab Activity [Guidelines]). Have students submit their plans a few days before the lab activity is conducted and check whether their plans are viable. Students can prepare for the lab activity by searching the Internet for information on their solutions, using key terms such as “test tube mystery,” “identification of unknowns,” and “unknown ionic solutions.” Remind students that the solubility chart and litmus tests can be used for acid and base identification. The colour and odour of solutions can also be used to identify the unknowns. Students who have prepared for the lab activity will have a better chance of being successful in identifying the unknowns.

Consult Appendix 1.9B: Test Tube Mystery: Lab Activity (Preparation Guide) for information on preparing for this lab activity before assigning it to students. A “possible” solution set is also provided in Appendix 1.9B. Teacher keys are available in Appendix 1.9C: Test Tube Mystery: Lab Activity (Teacher Key 1), which provides a sample grid of what students would bring to the lab, and in Appendix 1.9D: Test Tube Mystery: Lab Activity (Teacher Key 2), which provides a detailed synopsis of expected student observations post-lab.

**General Learning Outcome Connections**

- GLO C1:** Recognize safety symbols and practices related to scientific and technological activities and to their daily lives, and apply this knowledge in appropriate situations.
- GLO C2:** Demonstrate appropriate scientific inquiry skills when seeking answers to questions.
- GLO C4:** Demonstrate appropriate critical thinking and decision-making skills when choosing a course of action based on scientific and technological information.
- GLO C5:** Demonstrate curiosity, skepticism, creativity, open-mindedness, accuracy, precision, honesty, and persistence, and appreciate their importance as scientific and technological habits of mind.
- GLO C8:** Evaluate, from a scientific perspective, information and ideas encountered during investigations and in daily life.

**SKILLS AND ATTITUDES OUTCOMES**

**C12-0-S3:** Design and implement an investigation to answer a specific scientific question.

Include: materials, independent and dependent variables, controls, methods, and safety considerations

**C12-0-S4:** Select and use scientific equipment appropriately and safely.

Examples: volumetric glassware, balance, thermometer . . .

**C12-0-S5:** Collect, record, organize, and display data using an appropriate format.

Examples: labelled diagrams, graphs, multimedia applications, software integration, probeware . . .

**C12-0-S9:** Draw a conclusion based on the analysis and interpretation of data.

Include: cause-and-effect relationships, alternative explanations, and supporting or rejecting a hypothesis or prediction

---

**Laboratory Activity**

Provide students with 12 unlabelled samples of the solutions listed in Appendix 1.9B: Test Tube Mystery: Lab Activity (Preparation Guide).

Have students determine the identity of each solution using solubility rules, observation of colour and odour, flame tests, and litmus paper. See Appendix 1.9A: Test Tube Mystery: Lab Activity (Guidelines).

**SUGGESTIONS FOR ASSESSMENT**

---

**Laboratory Reports**

The suggested lab activity could be assessed as a formal lab report using the Laboratory Report Outline or the Laboratory Report Format (see *SYSTH* 11.38, 14.12). Word processing and spreadsheet software could be used to prepare reports. Also see the Lab Report Assessment rubric in Appendix 11.

**Laboratory Skills**

Create a short skill-based rubric to assess a predetermined set of lab skills. See Appendix 11 for a variety of rubrics and checklists that can be used for self-assessment, peer assessment, and teacher assessment.

Periodically and randomly review the lab skills of individual students, so that eventually all students are assessed. Sample checklists for assessing lab skills and work habits are available in *SYSTH* (6.10, 6.11).

**Topic 1:  
Reactions in  
Aqueous Solutions**

---

**SPECIFIC LEARNING OUTCOME**

**C12-1-07:** Design and test a procedure to determine the identity of a variety of unknown solutions.

(continued)

---

**LEARNING RESOURCES LINKS**

---



*Glencoe Chemistry: Matter and Change* (Dingrando, et al. 617)

*McGraw-Hill Ryerson Chemistry, Combined Atlantic Edition* (Mustoe, et al. 600)

*Prentice Hall Chemistry* (Wilbraham, et al. 612)

**Investigations**

*Glencoe Chemistry: Concepts and Applications* (Phillips, Strozak, and Wistrom)  
ChemLab: Solution Identification, 456

*McGraw-Hill Ryerson Inquiry into Chemistry* (Chastko, et al.)

Thought Lab 7.1: Identifying Unknown Aqueous Solutions, 267

**Appendices**

Appendix 1.9A: Test Tube Mystery: Lab Activity (Guidelines)

Appendix 1.9B: Test Tube Mystery: Lab Activity (Preparation Guide)

Appendix 1.9C: Test Tube Mystery: Lab Activity (Teacher Key 1)

Appendix 1.9D: Test Tube Mystery: Lab Activity (Teacher Key 2)

**Selecting Learning Resources**

For additional information on selecting learning resources for Grade 11 and Grade 12 Chemistry, see the Manitoba Education website at <[www.edu.gov.mb.ca/k12/learnres/bibliographies.html](http://www.edu.gov.mb.ca/k12/learnres/bibliographies.html)>.



**SKILLS AND ATTITUDES OUTCOMES**

**C12-0-S3:** Design and implement an investigation to answer a specific scientific question.

Include: materials, independent and dependent variables, controls, methods, and safety considerations

**C12-0-S4:** Select and use scientific equipment appropriately and safely.

*Examples: volumetric glassware, balance, thermometer . . .*

**C12-0-S5:** Collect, record, organize, and display data using an appropriate format.

*Examples: labelled diagrams, graphs, multimedia applications, software integration, probeware . . .*

**C12-0-S9:** Draw a conclusion based on the analysis and interpretation of data.

Include: cause-and-effect relationships, alternative explanations, and supporting or rejecting a hypothesis or prediction

---

**NOTES**

**Topic 1:  
Reactions in  
Aqueous Solutions**

**SPECIFIC LEARNING OUTCOME**

**C12-1-08:** Outline the development of scientific understanding of oxidation and reduction reactions.

Include: gain and loss of electrons, oxidizing agent, and reducing agent

(0.5 hour)

SLO: C12-1-08

**SUGGESTIONS FOR INSTRUCTION**

**Entry-Level Knowledge**

In Grade 10 Science (S2-2-01, S2-2-02, S2-2-03, and S2-2-04), students were shown the significance of the electron and nuclear charge with respect to periodicity and the reaction between elements to produce ionic and covalent compounds.

In addressing specific learning outcome C12-1-08, students develop an understanding of how loss and gain of electrons can be considered to be either an oxidation process or a reduction process.

**Assessing Prior Knowledge**

Check for students' understanding of prior knowledge and review concepts as necessary. Prior knowledge can be reviewed and/or assessed by using any of the KWL strategies (e.g., Concept Map, Knowledge Chart, Think-Pair-Share – see *SYSTH*, Chapter 9).

**Demonstration/Activating Activity**

The following demonstration can be performed to introduce this learning outcome. Place 20 g of copper(II) chloride dihydrate ( $\text{CuCl}_2 \cdot 2\text{H}_2\text{O}$ ) in a 250 mL beaker and dissolve it in 175 mL of water. Loosely crumple a 10 cm  $\times$  10 cm piece of aluminum foil and place it in the solution.

Encourage students to note their observations carefully at the macro level for later discussions related to activity at the molecular level. For instance, ask students whether an aluminum tank could be used to transport a  $\text{CuCl}_2$  solution. Students could also explain why the following reaction does not occur:  $\text{Cu}_{(s)} + \text{AlCl}_{3(aq)}$ .

**Caution:**

This reaction is exothermic, so use precautions. Provide for adequate ventilation or use a fume hood.

**General Learning Outcome Connections**

**GLO D3:** Understand the properties and structures of matter, as well as various common manifestations and applications of the actions and interactions of matter.

**SKILLS AND ATTITUDES OUTCOMES**

**C12-0-U1:** Use appropriate strategies and skills to develop an understanding of chemical concepts.

*Examples: analogies, concept frames, concept maps, manipulatives, particulate representations, role-plays, simulations, sort-and-predict frames, word cycles . . .*

**C12-0-U2:** Demonstrate an understanding of chemical concepts.

*Examples: use accurate scientific vocabulary, explain concepts to others, compare and contrast concepts, apply knowledge to new situations and/or contexts, create analogies, use manipulatives . . .*

---

**TEACHER NOTES**

The information presented for learning outcome C12-1-12 should provide teachers with enough information to motivate students to learn more about the underlying processes or factors that cause oxidation and reduction reactions to occur (e.g., rocket propulsion, fireworks, antioxidants, photosynthesis, rusting, breathalyzers, to name a few of the applications).

**Oxidation and Reduction**

Oxidation and reduction reactions and the loss and gain of electrons have been studied since the early 1800s. Scientists have focused on oxidation and reduction reactions and the movement of electrons in addressing the energy crisis and the struggle against climate change on our planet.

Many scientists believe that hydrogen cells and fuel cells are the way of the future. If students are to make environmentally sound choices for the future, they should understand the current electrochemical technologies they will be using. Provide students with a brief overview of these technologies as a preparation for a detailed discussion of electrochemistry in Topic 6: Electrochemistry.

The term *oxidation* was first applied to the combining of oxygen with other elements (e.g., rusting iron or burning carbon or methane). Burning is another name for rapid oxidation.

The term *reduction* originally meant the removal of oxygen from a compound. It comes from the fact that the free metal has a lower mass than its oxide compound. There is a decrease or reduction in the mass of the material as the oxygen is removed.

**Differentiating between Oxidation and Reduction: Examples**

From their prior knowledge, students should have some familiarity with oxidation through burning, or combustion, and the rotting of food. Students should have observed the burning of magnesium metal in Grade 11 Chemistry. Remind students that burning, or combustion, is the reaction of a substance with the oxygen gas in the air.

**Topic 1:**  
**Reactions in**  
**Aqueous Solutions**

**SPECIFIC LEARNING OUTCOME**

**C12-1-08:** Outline the development of scientific understanding of oxidation and reduction reactions.

Include: gain and loss of electrons, oxidizing agent, and reducing agent

(continued)

Example 1:

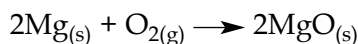

If this reaction is written in ionic form, it becomes

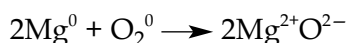

Observations

- Non-scientists usually refer to this reaction as burning, or combustion, but scientists refer to it as oxidation.
- Both magnesium and oxygen gases are elements and have no charge.
- The magnesium has been oxidized to MgO by the reaction with oxygen gas.
- Considering the charges, the metal has gone from 0 charge to 2+ charge, and the non-metal from 0 charge to 2- charge.

Historically, chemists recognized that other non-metallic elements unite with substances in a manner similar to that of oxygen (e.g., hydrogen, antimony, and sodium will burn in chlorine, iron will burn in fluorine). Therefore, the terms *oxidation* and *reduction* were redefined as follows:

- **Oxidation:** the process by which electrons are removed from an atom or ion.
- **Reduction:** the process by which any atom or ion gains electrons.

If we look at the change in ion charge as a function of electrons, the following relationships can be written as



In this equation, charge is conserved.  
There is 0 charge on both sides.

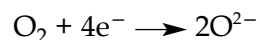

In this equation, charge is conserved.  
There is 4<sup>-</sup> charge on both sides.

By doubling the Mg relationship, the electrons are lost by the Mg and gained by the oxygen balance.

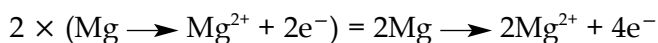

This results in the balanced equation

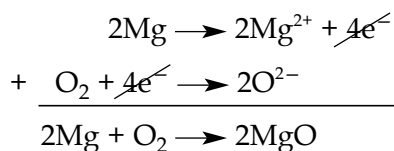

**SKILLS AND ATTITUDES OUTCOMES**

**C12-0-U1:** Use appropriate strategies and skills to develop an understanding of chemical concepts.

*Examples: analogies, concept frames, concept maps, manipulatives, particulate representations, role-plays, simulations, sort-and-predict frames, word cycles . . .*

**C12-0-U2:** Demonstrate an understanding of chemical concepts.

*Examples: use accurate scientific vocabulary, explain concepts to others, compare and contrast concepts, apply knowledge to new situations and/or contexts, create analogies, use manipulatives . . .*

---

Using this example, we could say that Mg is oxidized (combines with oxygen).

- Mg gains a positive charge by becoming an ion.
- This change occurs by a loss of electrons.

Can we apply these generalizations to other reactions?

*Example 2:*

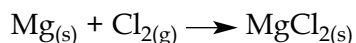

If this reaction is written in ionic form, it becomes

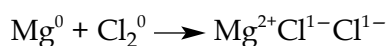

Recall that  $2\text{Cl}^{1-}$  ions are required to balance the  $2+$  charges of the Mg ion to form  $\text{MgCl}_2$ .

As in the first example, we can write the reaction as an ionic representation.



In this equation, charge is conserved.  
There is 0 charge on both sides.

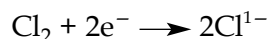

In this equation, charge is conserved.  
There is  $2^-$  charge on both sides.

Using this example, we could say that Mg is again oxidized.

- Mg gains a positive charge to become an ion.
- This change occurs by a loss of electrons.

A complementary reaction is that a Cl atom becomes a  $\text{Cl}^{1-}$ .

- Cl is reduced to a negative ion.
- This change occurs by a gain of electrons.

Based on these generalizations, chemists have defined *oxidation* as a loss of electrons, and *reduction* as a gain of electrons.

Mnemonics such as the following may help students differentiate between oxidation and reduction:

- OIL RIG – oxidation is losing and reduction is gaining
- LEO GER – losing electrons oxidation and gaining electrons reduction

**Topic 1:  
Reactions in  
Aqueous Solutions**

---

**SPECIFIC LEARNING OUTCOME****C12-1-08:** Outline the development of scientific understanding of oxidation and reduction reactions.

Include: gain and loss of electrons, oxidizing agent, and reducing agent

*(continued)*

---

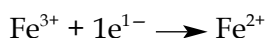
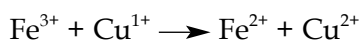
*Example 3:*

Gain of electrons – reduction



Loss of electrons – oxidation

There are basically two types of chemical reactions: those that do not have any apparent electron change and those that do. The second type of chemical reaction, in which electrons are transferred (lost or gained) between reactants, is called an *oxidation-reduction reaction* or a *redox reaction*.

**Animations/Simulations**

Have students view online animations or simulations illustrating a redox reaction at the molecular level.

*Sample Website:*

Chemical Education Research Group, Iowa State University. "Chemistry Experiment Simulations and Conceptual Computer Animations." *Chemical Education*. <<http://group.chem.iastate.edu/Greenbowe/sections/projectfolder/simDownload/index4.html>> (22 Nov. 2012).

In the Electrochemistry section, download and unzip the following animations:

- Zinc Copper REDOX Transfer
- Lead Silver REDOX Transfer

In the Electrochemistry section, download and unzip the following simulation:

- Reactions of Metals and Metal Ions Experiment

In this simulation, electrons are transferred from zinc atoms to copper(II) ions. The animation shows electron exchange at the particulate level and gives a detailed explanation of the process occurring.

**Compare and Contrast**

Have students start working on Appendix 1.10A: Compare and Contrast Oxidation and Reduction. Students will be able to complete this frame once they have been introduced to learning outcome C12-1-09.

**SKILLS AND ATTITUDES OUTCOMES**

**C12-0-U1:** Use appropriate strategies and skills to develop an understanding of chemical concepts.

*Examples: analogies, concept frames, concept maps, manipulatives, particulate representations, role-plays, simulations, sort-and-predict frames, word cycles . . .*

**C12-0-U2:** Demonstrate an understanding of chemical concepts.

*Examples: use accurate scientific vocabulary, explain concepts to others, compare and contrast concepts, apply knowledge to new situations and/or contexts, create analogies, use manipulatives . . .*

---

**SUGGESTIONS FOR ASSESSMENT**

---

**Paper-and-Pencil Tasks**

1. Give students an example of a chemical reaction and ask them to identify the substance being oxidized and the substance being reduced, as well as determine the numbers of electrons lost and gained to conserve charge. Students should be able to write the half-reactions; however, at this point, teachers would not likely use the term.

Examples of chemical reactions such as the following can be drawn from Grade 11 Chemistry:

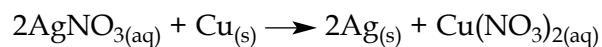

Based on their prior knowledge, students can remove spectator ions from reactions.

2. Ask students to determine which of the following are oxidation reactions and which are reduction reactions. Students should be able to explain their answers.

*Examples:*

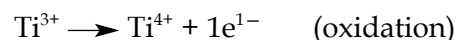
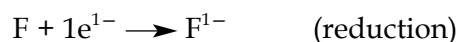
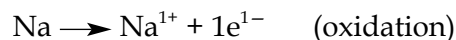

3. Have students answer the following question:

Why must oxidation and reduction reactions occur together?

**Topic 1:  
Reactions in  
Aqueous Solutions**

**SPECIFIC LEARNING OUTCOME**

**C12-1-08:** Outline the development of scientific understanding of oxidation and reduction reactions.

Include: gain and loss of electrons, oxidizing agent, and reducing agent

(continued)

**LEARNING RESOURCES LINKS**



*Chemistry* (Chang 127)

*Chemistry* (Zumdahl and Zumdahl 164)

*Chemistry: The Molecular Nature of Matter and Change* (Silberberg 151)

*Glencoe Chemistry: Concepts and Applications* (Phillips, Strozak, and Wistrom 556)

*Glencoe Chemistry: Matter and Change* (Dingrando, et al. 637, 657)

*McGraw-Hill Ryerson Chemistry, Combined Atlantic Edition* (Mustoe, et al. 713)

*McGraw-Hill Ryerson Inquiry into Chemistry* (Chastko, et al. 434)

*Nelson Chemistry 12, Ontario Edition* (van Kessel, 652)

*Nelson Chemistry 12: College Preparation, Ontario Edition* (Davies, et al.)  
Particulate Representation, 374

*Prentice Hall Chemistry* (Wilbraham, et al. 631)

**Demonstration**

*Merrill Chemistry: A Modern Course, Teacher Annotated Edition* (Smoot, Price, and Smith 507)

**Website**

Chemical Education Research Group, Iowa State University. "Chemistry Experiment Simulations and Conceptual Computer Animations." *Chemical Education*. <<http://group.chem.iastate.edu/Greenbowe/sections/projectfolder/simDownload/index4.html>> (22 Nov. 2012).

Animations: Zinc Copper REDOX Transfer

Lead Silver REDOX Transfer

Simulation: Reactions of Metals and Metal Ions Experiment

**Appendices**

Appendix 1.10A: Compare and Contrast Oxidation and Reduction

Appendix 1.10B: Compare and Contrast Oxidation and Reduction (Sample Response)

**Selecting Learning Resources**

For additional information on selecting learning resources for Grade 11 and Grade 12 Chemistry, see the Manitoba Education website at <[www.edu.gov.mb.ca/k12/learnres/bibliographies.html](http://www.edu.gov.mb.ca/k12/learnres/bibliographies.html)>.



**SKILLS AND ATTITUDES OUTCOMES**

**C12-0-U1:** Use appropriate strategies and skills to develop an understanding of chemical concepts.

*Examples: analogies, concept frames, concept maps, manipulatives, particulate representations, role-plays, simulations, sort-and-predict frames, word cycles . . .*

**C12-0-U2:** Demonstrate an understanding of chemical concepts.

*Examples: use accurate scientific vocabulary, explain concepts to others, compare and contrast concepts, apply knowledge to new situations and/or contexts, create analogies, use manipulatives . . .*

---

**NOTES**

**Topic 1:  
Reactions in  
Aqueous Solutions**

## SPECIFIC LEARNING OUTCOME

C12-1-09: Determine the oxidation numbers for atoms in compounds and ions.

(1 hour)

SLO: C12-1-09

**SUGGESTIONS FOR INSTRUCTION****Entry-Level Knowledge**

Students should be familiar with the concepts of oxidation and reduction from learning outcome C12-1-08.

**TEACHER NOTES**

Now that students can differentiate between oxidation and reduction reactions, give them an opportunity to discover that in complex reactions it is not always obvious what is being reduced or oxidized.

Chemists have created a set of rules to allow us to determine more easily the oxidation number of a given element within a compound or complex ion.

All chemistry texts provide rules for assigning oxidation numbers. Although the rules provided in texts will vary slightly, they will give the same value for oxidation numbers. One such set of rules is provided in Appendix 1.11: Oxidation Number Rules.

Remind students that the ion charge is written as  $2+$ , whereas the oxidation number is written as  $+2$ .

**Determining Oxidation Numbers: Examples**

There are many ways to set up or explain the arithmetic process for finding oxidation numbers. One such method is illustrated in the following examples, using the nine rules identified in Appendix 1.11: Oxidation Number Rules. See the Teacher Background notes that follow the examples.

For the following examples, determine the oxidation number of the elements written in **bold**.

**General Learning Outcome Connections**

**GLO D3:** Understand the properties and structures of matter, as well as various common manifestations and applications of the actions and interactions of matter.

**SKILLS AND ATTITUDES OUTCOMES**

**C12-0-U1:** Use appropriate strategies and skills to develop an understanding of chemical concepts.

*Examples: analogies, concept frames, concept maps, manipulatives, particulate representations, role-plays, simulations, sort-and-predict frames, word cycles . . .*

**C12-0-U2:** Demonstrate an understanding of chemical concepts.

*Examples: use accurate scientific vocabulary, explain concepts to others, compare and contrast concepts, apply knowledge to new situations and/or contexts, create analogies, use manipulatives . . .*

*Example 1:*



Rule 4 tells us that the oxidation number of  $\text{H}^{1+} = +1$ , and rule 5 tells us that  $\text{O}^{2-} = -2$ . These numbers can be written in the appropriate places as indicated.

The total charge is calculated on the bottom (i.e., for H,  $+1 \times 1 = +1$ ; for O,  $-2 \times 3 = -6$ ).

+1	?	-2
H	N	O <sub>3</sub>
+1	?	-6

The oxidation numbers are written on top.

The total charges are written on the bottom.

Rule 3 tells us the sum of the bottom charges must be 0.

Thus, the unknown (?) on the bottom line must be +5.

+1	?	-2
H	N	O <sub>3</sub>
+1	+5	-6

Since there is only one N, the oxidation number of N must be +5.

+1	+5	-2
H	N	O <sub>3</sub>
+1	+5	-6

**Topic 1:**  
**Reactions in**  
**Aqueous Solutions**

**SPECIFIC LEARNING OUTCOME**

**C12-1-09:** Determine the oxidation numbers for atoms in compounds and ions.

(continued)

Example 2:

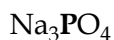

Rule 6 tells us that the oxidation number of  $\text{Na}^{1+} = +1$ , and rule 5 tells us that  $\text{O}^{2-} = -2$ . These numbers can be written in the appropriate places as indicated.

The total charge is calculated on the bottom (i.e., for O,  $-2 \times 4 = -8$ ; for Na,  $+1 \times 3 = +3$ ).

+1	?	-2
$\text{Na}_3$	<b>P</b>	$\text{O}_4$
+3	?	-8

The oxidation numbers are written on top.

The total charges are written on the bottom.

Rule 3 tells us the sum of the bottom charges must be 0.

Thus, the unknown (?) on the bottom line must be +5.

+1	?	-2
$\text{Na}_3$	<b>P</b>	$\text{O}_4$
+3	<b>+5</b>	-8

Since there is only one **P**, the oxidation number of **P** must be +5.

+1	<b>+5</b>	-2
$\text{Na}_3$	<b>P</b>	$\text{O}_4$
+3	+5	-8

**SKILLS AND ATTITUDES OUTCOMES**

**C12-0-U1:** Use appropriate strategies and skills to develop an understanding of chemical concepts.

*Examples: analogies, concept frames, concept maps, manipulatives, particulate representations, role-plays, simulations, sort-and-predict frames, word cycles . . .*

**C12-0-U2:** Demonstrate an understanding of chemical concepts.

*Examples: use accurate scientific vocabulary, explain concepts to others, compare and contrast concepts, apply knowledge to new situations and/or contexts, create analogies, use manipulatives . . .*

Example 3:

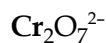

This is a complex ion with an overall charge of 2-. This time the bottom charges must sum 2-. Rule 5 tells us  $\text{O}^{2-} = -2$ .

?	-2	
$\text{Cr}_2$	$\text{O}_7^{2-}$	
?	-14	

According to rule 3,  $-14 + ? = -2$ ; therefore, the unknown (?) must be +12.

?	-2	
$\text{Cr}_2$	$\text{O}_7^{2-}$	
<b>+12</b>	-14	

However, there are 2 Cr atoms; therefore, the oxidation number of each Cr must be +6.

<b>+6</b>	-2	
$\text{Cr}_2$	$\text{O}_7^{2-}$	
<b>+12</b>	-14	

**Topic 1:**  
**Reactions in**  
**Aqueous Solutions**

## SPECIFIC LEARNING OUTCOME

C12-1-09: Determine the oxidation numbers for atoms in compounds and ions.

(continued)

*Other Examples:*

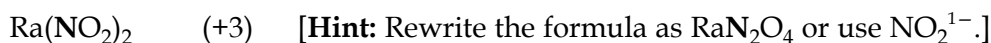
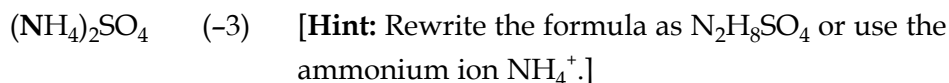

This method is more visual in nature than other methods. Some chemistry texts use a purely algebraic solution that will work for some students.

### Teacher Background

Many chemistry texts mention the oxidation states of hydrides, peroxides, and superoxides. This background information should assist teachers in giving students clear explanations, and should be considered for an extension or enrichment learning experience.

1. **Ionic hydrides** occur when hydrogen reacts with a reactive metal, such as the alkali metals or alkaline earth family.

*Examples:*



2. **Covalent hydrides** occur when the hydrogen atom is covalently bonded to the atom of another element. There are two types of covalent hydrides: those containing discrete molecular units, such as  $\text{CH}_4$  and  $\text{NH}_3$ , and those that have more complex structures, such as  $(\text{BeH}_2)_x$  and  $(\text{AlH}_3)_x$ .

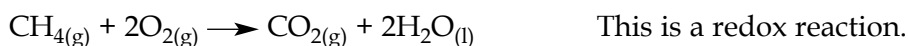

The carbon in  $\text{CH}_4$  has an oxidation number of  $-4$  going to  $+4$  in  $\text{CO}_2$ , whereas the oxygen atom goes from  $0$  in free oxygen to  $-2$  in both  $\text{CO}_2$  and  $\text{H}_2\text{O}$ .

3. **Ionic peroxides** are usually listed as an exception to the normal rules for assigning oxidation numbers for oxygen. They are known for the alkali metals: calcium, strontium, and barium. The ionic peroxides with water or dilute acids produce  $\text{H}_2\text{O}_2$ , and are powerful oxidizing agents.

The peroxide ion is  $\text{O}_2^{2-}$ , in which the O atom has a  $-1$  oxidation number.

**SKILLS AND ATTITUDES OUTCOMES**

**C12-0-U1:** Use appropriate strategies and skills to develop an understanding of chemical concepts.

*Examples: analogies, concept frames, concept maps, manipulatives, particulate representations, role-plays, simulations, sort-and-predict frames, word cycles . . .*

**C12-0-U2:** Demonstrate an understanding of chemical concepts.

*Examples: use accurate scientific vocabulary, explain concepts to others, compare and contrast concepts, apply knowledge to new situations and/or contexts, create analogies, use manipulatives . . .*

4. **Superoxides** are a group of compounds that contain the  $\text{O}_2^-$  ion. Under excess  $\text{O}_2$  conditions, alkali metals will undergo combustion reactions that generate several different products: oxides, peroxides, and superoxides. The superoxide ion  $\text{O}_2^-$  and, therefore, the O atom have an oxidation number of  $-\frac{1}{2}$ .

Potassium, rubidium, and cesium form stable, solid superoxide compounds that decompose when they contact water, releasing  $\text{O}_2$  gas. This reaction is used in specialized breathing equipment. Moisture from a person's breath will start the reaction, releasing oxygen gas:



Furthermore,  $\text{KO}_2$  will react with  $\text{CO}_2$  in the breath to release even more oxygen:

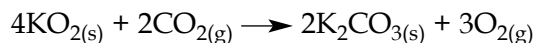

As always, work through all examples before assigning them to students in case fractional oxidation numbers arise. This may not be a problem in relation to learning outcome C12-1-09, but it could provide a challenge when students are balancing redox reactions in addressing learning outcome C12-1-10 (e.g.,  $\text{Fe}_3\text{O}_4$ , where the oxidation number of Fe would be  $+8/3$ ).

**Identifying Oxidation Numbers**

Have students identify the oxidation number for sulphur in each of the following compounds:  $\text{Na}_2\text{SO}_4$ ,  $\text{H}_2\text{S}$ ,  $\text{S}$ ,  $\text{S}_2\text{Cl}_2$ ,  $\text{SO}_2$ , and  $\text{K}_2\text{S}_2\text{O}_3$ . Ask them to organize these substances in order of increasing oxidation number (Dingrando, et al., *Glencoe Chemistry: Matter and Change, Teacher Wraparound Edition* 641).

**Topic 1:  
Reactions in  
Aqueous Solutions**

---

**SPECIFIC LEARNING OUTCOME****C12-1-09:** Determine the oxidation numbers for atoms in compounds and ions.*(continued)*

---

**SUGGESTIONS FOR ASSESSMENT**

---

**Paper-and-Pencil Tasks**

1. Students should be able to determine the oxidation numbers for atoms in compounds and ions. A host of chemistry texts contain examples for students to practise assigning oxidation numbers. Students can be presented with sealed test tubes of substances with the formulas of the substances listed on the test tubes.

Students can determine the oxidation number for each atom that is given in the chemical formula (Dingrando, et al., *Glencoe Chemistry: Matter and Change, Teacher Wraparound Edition* 643).

2. Have students complete Appendix 1.10A: Compare and Contrast Oxidation and Reduction, which they started in relation to learning outcome C12-1-08 (see Appendix 1.10B for a sample response).

**Journal Writing**

Ask students to propose how the rotting of food relates to oxidation and combustion. Ask them to explain how burning and rusting are similar and yet quite different.

---

**LEARNING RESOURCES LINKS**

---



*Glencoe Chemistry: Matter and Change* (Dingrando, et al.)  
Determining Oxidation Numbers, 641  
Oxidation Number in Redox Reactions, 643

*Glencoe Chemistry: Matter and Change, Teacher Wraparound Edition* (Dingrando, et al. 641, 643)

*McGraw-Hill Ryerson Chemistry, Combined Atlantic Edition* (Mustoe, et al.)  
Oxidation Numbers, 721

*Nelson Chemistry 12: College Preparation, Ontario Edition* (Davies, et al.)  
5.2: Redox Reactions of Nonmetals, 379

*Prentice Hall Chemistry* (Wilbraham, et al.)  
Section 20.2: Oxidation Numbers, 639

**Appendices**

Appendix 1.10A: Compare and Contrast Oxidation and Reduction

Appendix 1.10B: Compare and Contrast Oxidation and Reduction (Sample Response)

Appendix 1.11: Oxidation Number Rules



**SKILLS AND ATTITUDES OUTCOMES**

**C12-0-U1:** Use appropriate strategies and skills to develop an understanding of chemical concepts.

*Examples: analogies, concept frames, concept maps, manipulatives, particulate representations, role-plays, simulations, sort-and-predict frames, word cycles . . .*

**C12-0-U2:** Demonstrate an understanding of chemical concepts.

*Examples: use accurate scientific vocabulary, explain concepts to others, compare and contrast concepts, apply knowledge to new situations and/or contexts, create analogies, use manipulatives . . .*

---

**Selecting Learning Resources**

For additional information on selecting learning resources for Grade 11 and Grade 12 Chemistry, see the Manitoba Education website at <[www.edu.gov.mb.ca/k12/learnres/bibliographies.html](http://www.edu.gov.mb.ca/k12/learnres/bibliographies.html)>.

**Topic 1:  
Reactions in  
Aqueous Solutions****SPECIFIC LEARNING OUTCOME****C12-1-10:** Identify reactions as redox or non-redox.

Include: oxidizing agent, reducing agent, oxidized substance, and reduced substance

**(0.5 hour)**

SLO: C12-1-10

**SUGGESTIONS FOR INSTRUCTION****Entry-Level Knowledge**

Students should be familiar with the concepts of oxidation and reduction from learning outcome C12-1-09.

In Grade 10 (S2-2-06), students were introduced to the conservation of atoms in a reaction, and in Grade 11 Chemistry (C11-3-05, C11-3-12, and C11-3-13), they learned about the conservation of atoms and mass during a chemical reaction.

**Assessing Prior Knowledge**

Check for students' understanding of prior knowledge and review concepts as necessary.

**Demonstrations**

Prepare a beaker of weak silver nitrate solution and add to it a length of coiled bare copper wire. Have students observe (and recall from Grade 11 Chemistry) the chemical reaction that occurs. Can they propose an explanation? Does the reverse reaction occur?

Use a weak solution of copper nitrate and silver metal to demonstrate the non-spontaneous reverse reaction of the above demonstration.

Demonstrate a number of reactive solutions involving oxidation-reduction (e.g., copper plus zinc sulphate and zinc plus copper sulphate). The choices that are farther apart on the Standard Reduction Potentials table would result in faster reactions. Illustrate this concept with enough detailed examples (such as the one that follows) to ensure students thoroughly understand the concept of oxidation and reduction and loss and gain of electrons. This understanding is critical to their success in Topic 6: Electrochemistry.

**General Learning Outcome Connections**

**GLO D3:** Understand the properties and structures of matter, as well as various common manifestations and applications of the actions and interactions of matter.

**SKILLS AND ATTITUDES OUTCOMES**

**C12-0-U1:** Use appropriate strategies and skills to develop an understanding of chemical concepts.

*Examples: analogies, concept frames, concept maps, manipulatives, particulate representations, role-plays, simulations, sort-and-predict frames, word cycles . . .*

**C12-0-U2:** Demonstrate an understanding of chemical concepts.

*Examples: use accurate scientific vocabulary, explain concepts to others, compare and contrast concepts, apply knowledge to new situations and/or contexts, create analogies, use manipulatives . . .*

*Example:*

Ionic equation:

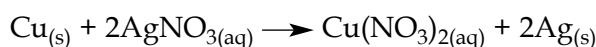

Net ionic equation:

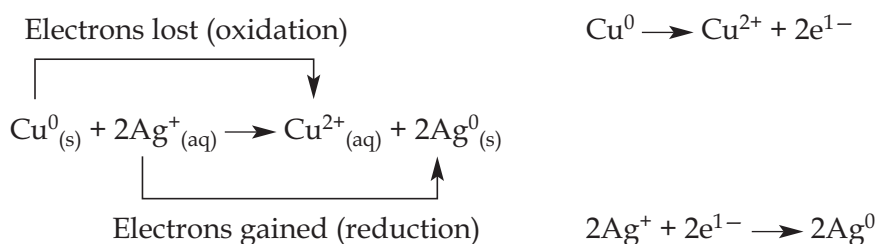

Note the following:

- A reducing agent causes the reduction of another species.
- An oxidizing agent causes the oxidation of another species.
- The substance being oxidized,  $\text{Cu}^0$ , is the reducing agent (also called an electron donor).
- The substance being reduced,  $\text{Ag}^+$ , is the oxidizing agent (also called an electron acceptor).

Some chemistry texts refer to *oxidation* as an increase in the oxidation state, whereas *reduction* is a reduction in the oxidation state.

Notice that each solid copper metal atom loses two electrons to form a copper(II) ion. Two silver ions pick up one of each of the copper electrons to form two silver atoms. The copper is oxidized and the silver is reduced – an oxidation-reduction electron transfer reaction (a redox reaction).

Each loss of electrons from a molecule must be offset by an equal gain of electrons in another molecule. Oxidation and reduction always accompany each other in reactions. They occur simultaneously. If a reaction does not have any transfer of electrons, it cannot be considered to be a redox reaction.

**Topic 1:**  
**Reactions in**  
**Aqueous Solutions**

**SPECIFIC LEARNING OUTCOME**

**C12-1-10:** Identify reactions as redox or non-redox.

Include: oxidizing agent, reducing agent, oxidized substance, and reduced substance

(continued)

**Sample Problem**

For the reaction,  $\text{Zn}_{(s)} + \text{Cu}^{2+}_{(aq)} \rightarrow \text{Zn}^{2+}_{(aq)} + \text{Cu}_{(s)}$ , indicate the following:

- State whether it is a redox or non-redox reaction.
- If it is a redox reaction, identify the oxidized substance, the reduced substance, the oxidizing agent, and the reducing agent.

*Solution:*

Step 1: Assign oxidation numbers to each substance based on the rules for assigning oxidation numbers.

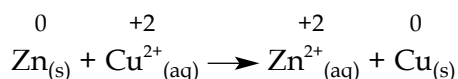

Step 2: Check which reactant is losing electrons. This will be the oxidized substance.

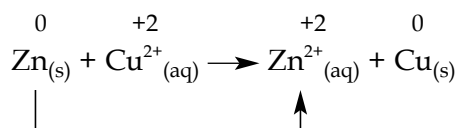

Zn is losing 2 electrons to form  $\text{Zn}^{2+}$ . Therefore, Zn is oxidized. Zn also is the reducing agent, as it supplies electrons to the reactant getting reduced.

Step 3: Check which reactant is gaining electrons. This will be the reduced substance.

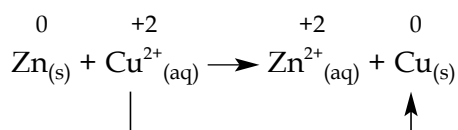

$\text{Cu}^{2+}$  is gaining 2 electrons to form Cu. Therefore,  $\text{Cu}^{2+}$  is reduced.  $\text{Cu}^{2+}$  also is the oxidizing agent, as it takes away electrons from the reactant being oxidized.

Step 4: Check whether a reduction and an oxidation occur. If both processes occur, then it is a redox reaction.

Steps 2 and 3 confirm that this is a redox reaction.

**SKILLS AND ATTITUDES OUTCOMES**

**C12-0-U1:** Use appropriate strategies and skills to develop an understanding of chemical concepts.

*Examples: analogies, concept frames, concept maps, manipulatives, particulate representations, role-plays, simulations, sort-and-predict frames, word cycles . . .*

**C12-0-U2:** Demonstrate an understanding of chemical concepts.

*Examples: use accurate scientific vocabulary, explain concepts to others, compare and contrast concepts, apply knowledge to new situations and/or contexts, create analogies, use manipulatives . . .*

**Teacher Background**

A special type of redox reaction is one in which two elements in the same compound change oxidation numbers. This is sometimes called a *disproportionation reaction*. Two such examples are provided below.

*Examples:*

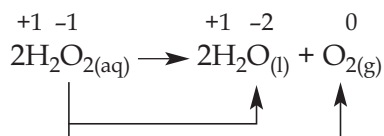
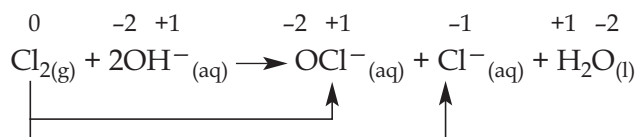
**Simulation**

Have students view an online simulation of a redox reaction.

*Sample Website:*

Chemical Education Research Group, Iowa State University. "Chemistry Experiment Simulations and Conceptual Computer Animations." *Chemical Education*. <<http://group.chem.iastate.edu/Greenbowe/sections/projectfolder/simDownload/index4.html>> (18 Jan. 2012).

In the Electrochemistry section, download and unzip the following simulation:

■ Reactions of Metals and Metal Ions Experiment

This simulation illustrates a redox reaction at the molecular level when a metal is immersed in aqueous ionic solution. Students can predict what will occur prior to placing the metal in the solution.

**Topic 1:**  
**Reactions in**  
**Aqueous Solutions**

## SPECIFIC LEARNING OUTCOME

C12-1-10: Identify reactions as redox or non-redox.

Include: oxidizing agent, reducing agent, oxidized substance, and reduced substance

(continued)

## SUGGESTIONS FOR ASSESSMENT

## Paper-and-Pencil Tasks

1. Have students solve problems dealing with the identification of redox and non-redox reactions.
2. Students should also be able to identify the oxidizing agent, reducing agent, oxidized substance, and reduced substance in a redox reaction. Use the convention that the “substance” is usually an atomic species, and therefore will not use an ionic notation (e.g., N, as opposed to  $N^{+5}$ ). Teachers may choose alternative ways of describing the substance oxidized or reduced, but consistency throughout is important.

*Examples:*

For each of the following reactions, students could determine the substance being oxidized, the substance being reduced, the oxidizing agent, and the reducing agent.

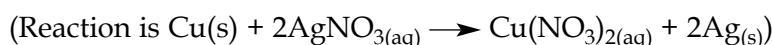
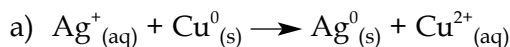

- Which substance is being oxidized?  $Cu^0_{(s)}$
- Which substance is being reduced?  $Ag^+_{(aq)}$
- What is the oxidizing agent?  $Ag^+_{(aq)}$
- What is the reducing agent?  $Cu^0_{(s)}$

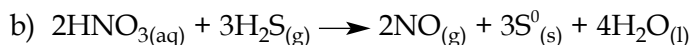

- Which substance is being oxidized? S
- Which substance is being reduced? N
- What is the oxidizing agent?  $HNO_{3(aq)}$
- What is the reducing agent?  $H_2S_{(g)}$

3. Students could create an analogy that shows each of the following terms: *oxidation*, *reduction*, *oxidizing agent*, and *reducing agent* (Dingrando, et al., *Glencoe Chemistry: Matter and Change, Teacher Wraparound Edition* 636).

### SKILLS AND ATTITUDES OUTCOMES

**C12-0-U1:** Use appropriate strategies and skills to develop an understanding of chemical concepts.

*Examples: analogies, concept frames, concept maps, manipulatives, particulate representations, role-plays, simulations, sort-and-predict frames, word cycles . . .*

**C12-0-U2:** Demonstrate an understanding of chemical concepts.

*Examples: use accurate scientific vocabulary, explain concepts to others, compare and contrast concepts, apply knowledge to new situations and/or contexts, create analogies, use manipulatives . . .*

---

### Three-Point Approach for Words and Concepts

Ask students to use the Three-Point Approach to describe the terms *oxidizing agent*, *reducing agent*, the *substance oxidized*, and the *substance reduced* (see SYSTH 10.22).

### Journal Writing

At least two mnemonic devices are often used to assist students with remembering the definition of oxidation and reduction:

- OIL RIG – oxidation is losing and reduction is gaining
- LEO GER – losing electrons oxidation and gaining electrons reduction

Students could have a creative time either artistically or with words to illustrate these mnemonic devices. For example, students could draw a cartoon or a short comic strip of an atom losing an electron to another atom (Dingrando, et al., *Glencoe Chemistry: Matter and Change, Teacher Wraparound Edition* 638).

### LEARNING RESOURCES LINKS

---



*Chemistry* (Chang 127)

*Chemistry* (Zumdahl and Zumdahl 169)

*Chemistry: The Molecular Nature of Matter and Change* (Silberberg 151)

*Glencoe Chemistry: Concepts and Applications* (Phillips, Strozak, and Wistrom 559)

*Glencoe Chemistry: Matter and Change* (Dingrando, et al.)

Section 20.1: Oxidation and Reduction, 635

*Glencoe Chemistry: Matter and Change, Teacher Wraparound Edition* (Dingrando, et al. 636, 638)

*McGraw-Hill Ryerson Chemistry, Combined Atlantic Edition* (Mustoe, et al. 726)

*McGraw-Hill Ryerson Inquiry into Chemistry* (Chastko, et al. 436)

*Nelson Chemistry 12, Ontario Edition* (van Kessel, et al. 674)

*Nelson Chemistry 12: College Preparation, Ontario Edition* (Davies, et al. 382)

*Prentice Hall Chemistry* (Wilbraham, et al.)

Section 20.1: The Meaning of Oxidation and Reduction, 631

### Investigation

*Glencoe Chemistry: Concepts and Applications* (Phillips, Strozak, and Wistrom)

ChemLab: Copper Atoms and Ions: Oxidation and Reduction, 560

---

**Topic 1:  
Reactions in  
Aqueous Solutions**

---

**SPECIFIC LEARNING OUTCOME**

**C12-1-10:** Identify reactions as redox or non-redox.

Include: oxidizing agent, reducing agent, oxidized substance, and reduced substance

(continued)

---

**Website**

Chemical Education Research Group, Iowa State University. "Chemistry Experiment Simulations and Conceptual Computer Animations."

*Chemical Education*. <<http://group.chem.iastate.edu/Greenbowe/sections/projectfolder/simDownload/index4.html>> (18 Jan. 2012).

Simulation: Reactions of Metals and Metal Ions Experiment

**Selecting Learning Resources**

For additional information on selecting learning resources for Grade 11 and Grade 12 Chemistry, see the Manitoba Education website at <[www.edu.gov.mb.ca/k12/learnres/bibliographies.html](http://www.edu.gov.mb.ca/k12/learnres/bibliographies.html)>.



**SKILLS AND ATTITUDES OUTCOMES**

**C12-0-U1:** Use appropriate strategies and skills to develop an understanding of chemical concepts.

*Examples: analogies, concept frames, concept maps, manipulatives, particulate representations, role-plays, simulations, sort-and-predict frames, word cycles . . .*

**C12-0-U2:** Demonstrate an understanding of chemical concepts.

*Examples: use accurate scientific vocabulary, explain concepts to others, compare and contrast concepts, apply knowledge to new situations and/or contexts, create analogies, use manipulatives . . .*

---

**NOTES**

**Topic 1:  
Reactions in  
Aqueous Solutions**

**SPECIFIC LEARNING OUTCOME**

**C12-1-11:** Balance oxidation-reduction reactions using redox methods.  
Include: acidic and basic solutions

(3 hours)

SLO: C12-1-11

**SUGGESTIONS FOR INSTRUCTION**

**Entry-Level Knowledge**

Students learned about the conservation of atoms in Grade 10 Science (S2-2-06), and about the conservation of atoms and mass during a chemical reaction in Grade 11 Chemistry (C11-3-12 and C11-3-13).

**Assessing Prior Knowledge**

Check for students' understanding of prior knowledge and review concepts as necessary.

**TEACHER NOTES**

There are two basic methods for balancing oxidation-reduction reactions. The method that deals with oxidation numbers is addressed here in Topic 1 as an introduction to redox reaction. The other more efficient method involving half-cell reactions is addressed in Topic 6, where oxidation potentials and the electromotive series can be discussed more comprehensively.

**Note:**

Because of the links between oxidation-reduction and electrochemistry, teachers may consider teaching Topic 6: Electrochemistry following learning outcome C12-1-11.

Generally, if the reaction is written in the molecular form, as in the first example that follows, then the acid or base will already be included in the reaction. In the case of ionic aqueous reactions,  $H^+$  ions or  $OH^-$  ions would need to be added to the appropriate side to balance both ion charge and elemental species. The following examples will clearly illustrate this.

**Oxidation-Number Change Method**

Use the steps illustrated in the following examples to balance a redox reaction using the oxidation-number change method. With this method, a redox equation is balanced by comparing the increases and decreases in oxidation numbers (i.e., electrons lost and gained).

**General Learning Outcome Connections**

**GLO D3:** Understand the properties and structures of matter, as well as various common manifestations and applications of the actions and interactions of matter.

**SKILLS AND ATTITUDES OUTCOMES**

**C12-0-U1:** Use appropriate strategies and skills to develop an understanding of chemical concepts.

*Examples: analogies, concept frames, concept maps, manipulatives, particulate representations, role-plays, simulations, sort-and-predict frames, word cycles . . .*

**C12-0-U2:** Demonstrate an understanding of chemical concepts.

*Examples: use accurate scientific vocabulary, explain concepts to others, compare and contrast concepts, apply knowledge to new situations and/or contexts, create analogies, use manipulatives . . .*

*Example 1:*

Balance the chemical reaction below, following the specified steps.

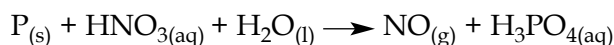

1. Assign oxidation numbers to all the atoms in the reaction. Write the numbers above the appropriate atoms.

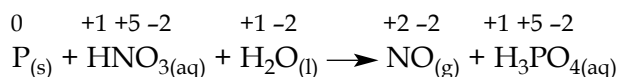

2. Identify which atoms are oxidized and which are reduced. Use a line to connect the atoms that undergo oxidation and the atoms that undergo reduction. Write the number of electrons lost/gained at the midpoint of each line.

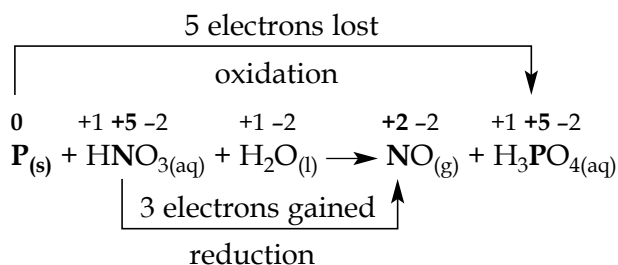

3. Balance the electrons lost and gained using appropriate coefficients.

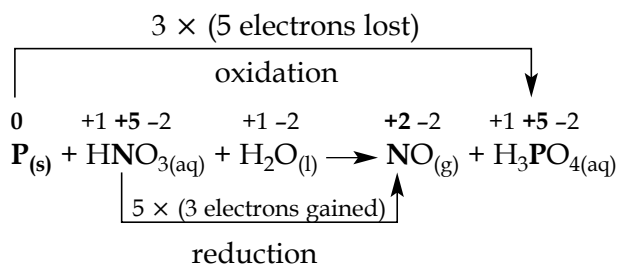

4. Place the coefficient 3 in front of the  $\text{P}_{(s)}$  and  $\text{H}_3\text{PO}_4$ , and place the coefficient 5 in front of  $\text{HNO}_3$  and  $\text{NO}$ .

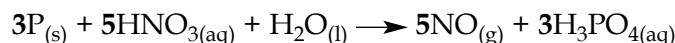

5. Balance all other atoms as you normally would and do a final check to see whether all atoms and charges are balanced. Balance the metals first, then the non-metals, then hydrogen, and finally, oxygen. If students balance the elements in that order, often the more complex O atom numbers are already done.

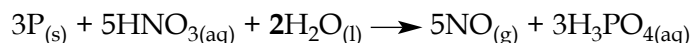

**Topic 1:**  
**Reactions in**  
**Aqueous Solutions**

**SPECIFIC LEARNING OUTCOME**

**C12-1-11:** Balance oxidation-reduction reactions using redox methods.  
Include: acidic and basic solutions

(continued)

*Example 2: Acidic Solution*

Balance the following aqueous oxidation-reduction reaction that occurs in an *acidic solution*.

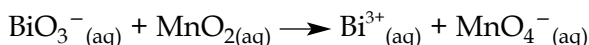

- Assign oxidation numbers to all the atoms in the reaction. Write the numbers above the appropriate atoms and show electrons lost and gained.

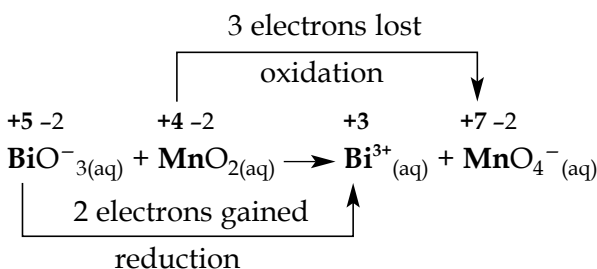

- Balance electrons lost and gained using appropriate coefficients.

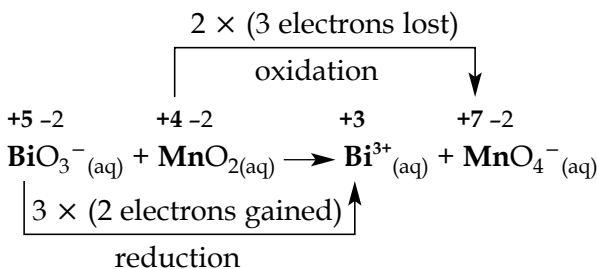

- Write the coefficients in front of the appropriate species.

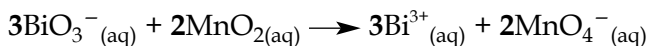

- Add up the ion charges and balance with  $\text{H}^+$ , since the reaction occurs in an *acidic solution*.

Total the charges on both sides separately.

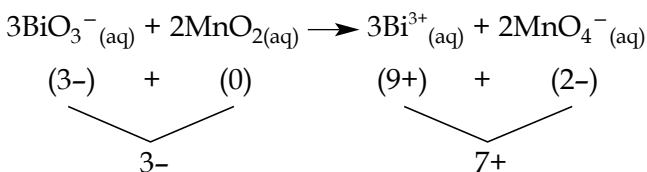

**SKILLS AND ATTITUDES OUTCOMES**

**C12-0-U1:** Use appropriate strategies and skills to develop an understanding of chemical concepts.

*Examples: analogies, concept frames, concept maps, manipulatives, particulate representations, role-plays, simulations, sort-and-predict frames, word cycles . . .*

**C12-0-U2:** Demonstrate an understanding of chemical concepts.

*Examples: use accurate scientific vocabulary, explain concepts to others, compare and contrast concepts, apply knowledge to new situations and/or contexts, create analogies, use manipulatives . . .*

Therefore,  $10\text{H}^+$  ions need to be added to the left side of the reaction to balance the ion charge.

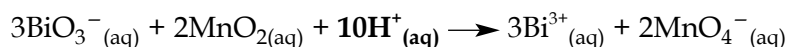

5. Water is now added to the opposite side to balance H and O atoms.

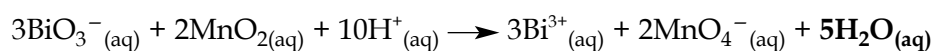

*Example 3: Basic Solution*

Balance the following aqueous oxidation-reduction reaction that occurs in a *basic solution*.

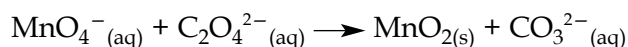

1. Assign oxidation numbers to all the atoms in the reaction. Write the numbers above the appropriate atoms and show electrons lost and gained.

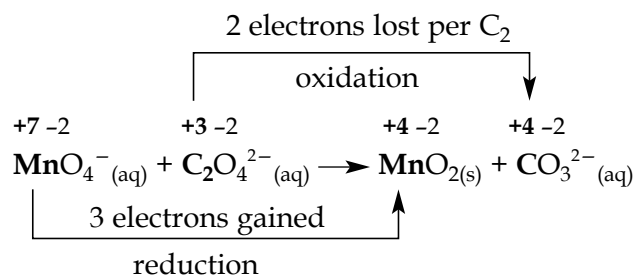

2. Balance electrons lost and gained using appropriate coefficients.

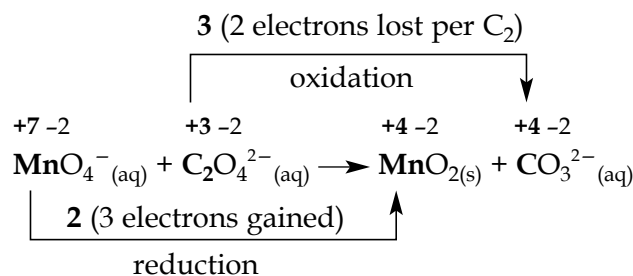

3. Write the coefficients in front of the appropriate species.

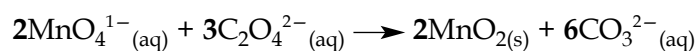

Note that  $6\text{CO}_3^{2-}$  is required to balance the C atoms in  $3\text{C}_2\text{O}_4^{2-}$ .

**Topic 1:**  
**Reactions in**  
**Aqueous Solutions**

**SPECIFIC LEARNING OUTCOME**

**C12-1-11:** Balance oxidation-reduction reactions using redox methods.  
Include: acidic and basic solutions

(continued)

4. Add up the ion charges and balance with  $\text{OH}^-$ , since the reaction occurs in a basic solution.

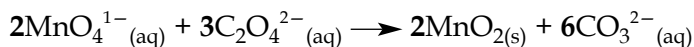

Total the charges on both sides separately.

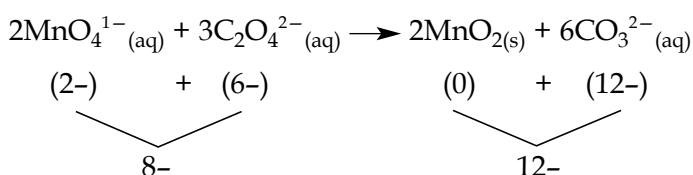

Therefore,  $4\text{OH}^-$  ions need to be added to the left side of the reaction to balance the ion charge.



5. Water is now added to the opposite side to balance H and O atoms.

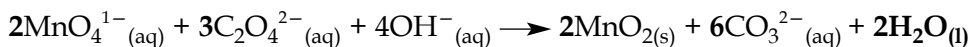

**Demonstration**

A breathalyzer test works on a redox reaction given below. If students like a challenge, ask them to balance this reaction.

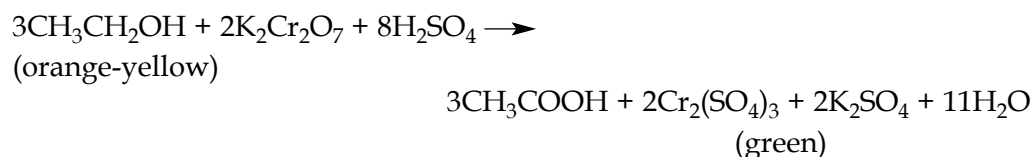

Historically, before laser spectrophotometry became prevalent in roadside breath analysis equipment, the driver being assessed provided a breath sample to a solution of potassium dichromate that was an orange-green colour. As the ethanol (if present in the sample) reacted with the acid, the solution would become increasingly green. The degree of change was then measured by a simple spectrophotometer. As the wavelength of emitted light shifted to green, it indicated a larger amount of dissolved alcohol in the breath. These traditional reagents are readily available in most school laboratories.

Build a simple breathalyzer and bubble denatured ethanol into it to test the change in colour. Generic mouthwash is a safe source to simulate alcohol on the breath.

What would happen if methanol or isopropyl alcohol were used instead of ethanol?

### SKILLS AND ATTITUDES OUTCOMES

**C12-0-U1:** Use appropriate strategies and skills to develop an understanding of chemical concepts.

*Examples: analogies, concept frames, concept maps, manipulatives, particulate representations, role-plays, simulations, sort-and-predict frames, word cycles . . .*

**C12-0-U2:** Demonstrate an understanding of chemical concepts.

*Examples: use accurate scientific vocabulary, explain concepts to others, compare and contrast concepts, apply knowledge to new situations and/or contexts, create analogies, use manipulatives . . .*

---

## SUGGESTIONS FOR ASSESSMENT

---

### Paper-and-Pencil Task

Have students balance redox equations using process notes (see *SYSTH* 13.14).

### Journal Writing

Students may wish to write an account of the technology that goes into the functioning and use of a traditional breathalyzer.

## LEARNING RESOURCES LINKS

---



*Glencoe Chemistry: Concepts and Applications* (Phillips, Strozak, and Wistrom)  
Breathalyzer Test, 569

*Glencoe Chemistry: Matter and Change* (Dingrando, et al.)  
Section 20.2: Balancing Redox Equations, 644  
The Oxidation-Number Method, 644  
Section 20.3: Half-Reactions, 650

*McGraw-Hill Ryerson Chemistry, Combined Atlantic Edition* (Mustoe, et al.)  
18.2: Oxidation Numbers, 721  
18.3: The Half-Reaction Method for Balancing Equations, 730

*Prentice Hall Chemistry* (Wilbraham, et al.)  
Section 20.3: Balancing Redox Equations, 645

#### Selecting Learning Resources

For additional information on selecting learning resources for Grade 11 and Grade 12 Chemistry, see the Manitoba Education website at <[www.edu.gov.mb.ca/k12/learnres/bibliographies.html](http://www.edu.gov.mb.ca/k12/learnres/bibliographies.html)>.

**Topic 1:**  
**Reactions in**  
**Aqueous Solutions**

**SPECIFIC LEARNING OUTCOME**

**C12-1-12:** Research practical applications of redox reactions.

*Examples: rocket fuels, fireworks, household bleach, photography, metal recovery from ores, steelmaking, aluminum recycling, fuel cells, batteries, tarnish removal, fruit clocks, forensic blood detection using luminol, chemiluminescence/bioluminescence, electrolytic cleaning, electrodeposition, photochemical etching, antioxidants/preservatives . . .*

**(4 hours)**

SLO: C12-1-12

**SUGGESTIONS FOR INSTRUCTION****TEACHER NOTES**

In addressing learning outcome C12-1-12, ask students to choose a research topic early in the school year so that they can research information and ideas on the practical applications of redox reactions over an extended period of time. Group presentations would be done during the study of Topic 6: Electrochemistry at the end of the course. In their research, students could focus their attention on

- the redox reaction taking place
- the effect of the process on the environment
- the energy consumption involved

Encourage students to investigate and perform demonstrations to support their oral presentations on their selected research topics.

**General Learning Outcome Connections**

- GLO A3:** Distinguish critically between science and technology in terms of their respective contexts, goals, methods, products, and values.
- GLO A4:** Identify and appreciate contributions made by women and men from many societies and cultural backgrounds that have increased our understanding of the world and brought about technological innovations.
- GLO A5:** Recognize that science and technology interact with and advance one another.
- GLO B1:** Describe scientific and technological developments—past and present—and appreciate their impact on individuals, societies, and the environment, both locally and globally.
- GLO B2:** Recognize that scientific and technological endeavours have been and continue to be influenced by human needs and the societal context of the time.
- GLO B4:** Demonstrate knowledge of and personal consideration for a range of possible science- and technology-related interests, hobbies, and careers.
- GLO C2:** Demonstrate appropriate scientific inquiry skills when seeking answers to questions.
- GLO C4:** Demonstrate appropriate critical thinking and decision-making skills when choosing a course of action based on scientific and technological information.
- GLO C5:** Demonstrate curiosity, skepticism, creativity, open-mindedness, accuracy, precision, honesty, and persistence, and appreciate their importance as scientific and technological habits of mind.
- GLO C6:** Employ effective communication skills and use information technology to gather and share scientific and technological ideas and data.
- GLO C7:** Work cooperatively and value the ideas and contributions of others while carrying out scientific and technological activities.
- GLO D3:** Understand the properties and structures of matter, as well as various common manifestations and applications of the actions and interactions of matter.



**SKILLS AND ATTITUDES OUTCOMES**

- C12-0-R1:** Synthesize information obtained from a variety of sources.  
Include: print and electronic sources, specialists, and other resource people
- C12-0-R5:** Communicate information in a variety of forms appropriate to the audience, purpose, and content.
- C12-0-C1:** Collaborate with others to achieve group goals and responsibilities.
- C12-0-C2:** Elicit, clarify, and respond to questions, ideas, and diverse points of view in discussions.
- C12-0-C3:** Evaluate individual and group processes.
- C12-0-T1:** Describe examples of the relationship between chemical principles and applications of chemistry.
- C12-0-T2:** Explain how scientific research and technology interact in the production and distribution of materials.
- C12-0-T3:** Provide examples of how chemical principles are applied in products and processes, in scientific studies, and in daily life.
- 

**Practical Applications of Redox Reactions: Research Topics**

Have groups of students research practical applications of redox reactions and prepare a written report and an oral presentation on their findings. The following information serves as an introduction to the various applications of redox reactions cited as examples in learning outcome C12-1-12. Choose examples that relate to student and teacher interest and experience. This material can be supplemented by additional research using the usual resources (e.g., Internet, texts, encyclopedias, journals, experts). Ideally, students would provide information from their own sphere of experience. For a sample assignment, see Appendix 1.12A: Practical Applications of Redox Reactions (Research Report and Presentation).

**■ Rocket Fuels**

Each solid rocket booster of the space shuttle, used during the first two minutes of a launch, contains 495 000 kg of an explosive mixture of ammonium perchlorate and aluminum:

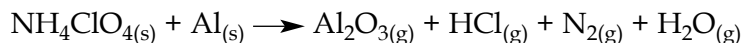
**■ Fireworks**

The heat and thrust of a fireworks shell are produced by exothermic redox reactions. A typical fireworks composition consists of an oxidizer (such as potassium perchlorate), a fuel (such as aluminum or magnesium), a binder, and some chemicals for the special effects of colour, sparks, and smoke. For example, green fireworks are made by adding a barium compound, and gold sparks are produced by adding iron filings or charcoal.

**Topic 1:**  
**Reactions in**  
**Aqueous Solutions**

**SPECIFIC LEARNING OUTCOME**

**C12-1-12:** Research practical applications of redox reactions.

*Examples: rocket fuels, fireworks, household bleach, photography, metal recovery from ores, steelmaking, aluminum recycling, fuel cells, batteries, tarnish removal, fruit clocks, forensic blood detection using luminol, chemiluminescence/bioluminescence, electrolytic cleaning, electrodeposition, photochemical etching, antioxidants/preservatives . . .*

(continued)

■ **Household Bleach**

Through the process of oxidation, unwanted colours (stains) are removed (oxidized) by bleach. Colour is caused by the movement of electrons between different energy levels of the atoms of the material.

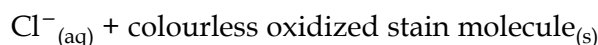
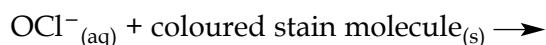

■ **Photography**

There are three different redox reactions in black-and-white photography:

1. The film negative is an emulsion of silver bromide:

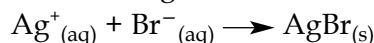

2. The film is processed, and the remaining  $\text{Ag}^+_{(\text{aq})}$  is converted to free silver by a reducing agent. The unreacted  $\text{AgBr}$  is removed by an appropriate solution process. This step produces the negative.

3. The negative is then printed onto photographic paper.

■ **Metal Recovery from Ores**

Aluminum metal is obtained by electrolysis of aluminum oxide (refined bauxite), using the Hall-Héroult process.

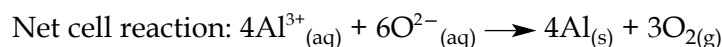

This process uses huge amounts of electric energy. Recycling of aluminum is a lot more cost-effective than the processing of bauxite.

Copper, silver, gold, platinum, and palladium are the only transition metals that are unreactive enough to be found in nature uncombined with other elements.

**SKILLS AND ATTITUDES OUTCOMES**

- C12-0-R1:** Synthesize information obtained from a variety of sources.  
 Include: print and electronic sources, specialists, and other resource people
- C12-0-R5:** Communicate information in a variety of forms appropriate to the audience, purpose, and content.
- C12-0-C1:** Collaborate with others to achieve group goals and responsibilities.
- C12-0-C2:** Elicit, clarify, and respond to questions, ideas, and diverse points of view in discussions.
- C12-0-C3:** Evaluate individual and group processes.
- C12-0-T1:** Describe examples of the relationship between chemical principles and applications of chemistry.
- C12-0-T2:** Explain how scientific research and technology interact in the production and distribution of materials.
- C12-0-T3:** Provide examples of how chemical principles are applied in products and processes, in scientific studies, and in daily life.
- 

**■ Steelmaking**

One aspect of steelmaking is the basic oxygen process used to purify iron (the most common method used). Scrap steel is mixed with molten iron in a blast furnace. Oxygen is introduced (injected) to oxidize the impurities.

**■ Aluminum Recycling**

All aluminum products can be recycled after use. Scrap aluminum is generally taken by road to the recycling plant, where it is checked and sorted to determine composition and value. If the scrap is of unknown quality, the aluminum will first be passed through some large magnets to remove any ferrous metal. Depending upon the type of contamination present, some scrap must be further processed. Beverage cans, for example, must have their lacquer removed prior to aluminum recovery.

**■ Fuel Cells**

The most common fuel cell is the hydrogen-oxygen fuel cell used in the space shuttle. Some automotive manufacturers are now using fuel cells as a means of power.

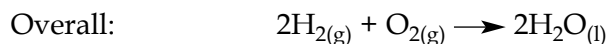
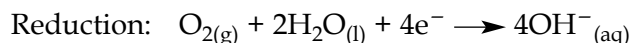
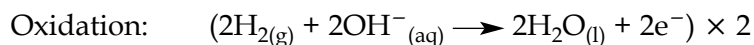
**■ Batteries**

The flow of electrons in a battery is possible because zinc is oxidized in the battery, and manganese dioxide ( $\text{MnO}_2$ ) is reduced. The following chemical reactions occur:

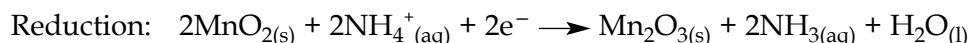
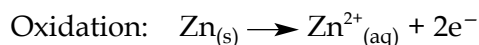

**Topic 1:**  
**Reactions in**  
**Aqueous Solutions**

**SPECIFIC LEARNING OUTCOME****C12-1-12:** Research practical applications of redox reactions.

*Examples: rocket fuels, fireworks, household bleach, photography, metal recovery from ores, steelmaking, aluminum recycling, fuel cells, batteries, tarnish removal, fruit clocks, forensic blood detection using luminol, chemiluminescence/bioluminescence, electrolytic cleaning, electrodeposition, photochemical etching, antioxidants/preservatives . . .*

(continued)

- **Tarnish Removal**

Silver tarnish ( $\text{Ag}_2\text{S}$ ) is formed by a redox reaction involving environmental sulphides. To remove the tarnish, aluminum reacts in the following way:

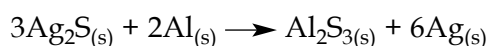

- **Fruit Clocks**

Inserting two electrodes of differing metals into a piece of fruit (such as a lemon) and connecting them with wires will cause an electric current to flow to a basic liquid-crystal display clock:

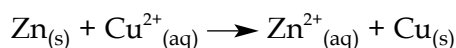

- **Forensic Blood Detection Using Luminol**

Criminalists spray a luminol mixture wherever they think blood might be found. If hemoglobin and the luminol mixture come in contact, the iron in the hemoglobin accelerates a reaction between the hydrogen peroxide and the luminol. In this oxidation reaction, the luminol loses nitrogen and hydrogen atoms and gains oxygen atoms, resulting in a compound called 3-aminophthalate. The reaction leaves the 3-aminophthalate in an energized state – the electrons in the oxygen atoms are boosted to higher orbitals. The electrons quickly fall back to a lower energy level, emitting the extra energy as a light photon. With iron accelerating the process, the light is bright enough to see in a dark room.

- **Chemiluminescence/Bioluminescence**

Most *chemiluminescence* methods involve only a few chemical components to generate light. Luminol chemiluminescence and peroxyoxalate chemiluminescence are both used in bioanalytical methods. In each system, a “fuel” is chemically oxidized to produce an excited-state product. In many luminol methods, it is this excited product that emits the light for the signal. In peroxyoxalate chemiluminescence, the initial excited-state product does not emit light at all; instead, it reacts with another compound, often a compound also viable as a fluorescent dye, and it is this fluorophore that becomes excited and emits light.

**SKILLS AND ATTITUDES OUTCOMES**

- C12-0-R1:** Synthesize information obtained from a variety of sources.  
Include: print and electronic sources, specialists, and other resource people
- C12-0-R5:** Communicate information in a variety of forms appropriate to the audience, purpose, and content.
- C12-0-C1:** Collaborate with others to achieve group goals and responsibilities.
- C12-0-C2:** Elicit, clarify, and respond to questions, ideas, and diverse points of view in discussions.
- C12-0-C3:** Evaluate individual and group processes.
- C12-0-T1:** Describe examples of the relationship between chemical principles and applications of chemistry.
- C12-0-T2:** Explain how scientific research and technology interact in the production and distribution of materials.
- C12-0-T3:** Provide examples of how chemical principles are applied in products and processes, in scientific studies, and in daily life.
- 

*Bioluminescence* is light produced by a chemical reaction within an organism. At least two chemicals are required. The one that produces the light is generically called a *luciferin* and the one that drives or catalyzes the reaction is called a *luciferase*.

**■ Electrolytic Cleaning**

Electrolysis can be used to clean metal objects, as explained by Dingrando, et al:

Coatings of salts from the seawater on metal objects are removed by an electrochemical process. A voltaic cell is set up with a cathode that is the object itself and a stainless steel anode in a basic solution. Chloride ions are removed when the electric current is turned on.

In another process, bacteria convert sulfate ions to hydrogen sulfide gas and cause silver coins and bars to become coated with silver sulfide after long periods of time at the bottom of the ocean. In an electrolytic cell, the silver in silver sulfide can be reduced to silver metal and reclaimed. (*Glencoe Chemistry: Matter and Change, Teacher Wraparound Edition 684*)

**■ Electrodeposition**

The process used in electroplating is called *electrodeposition* (e.g., making CDs). The item to be coated is placed into a solution of one or more metal salts. The item is connected to an electrical circuit, forming the cathode (negative) of the circuit, while the anode (positive) is typically made of the metal to be plated on the item. When an electrical current is passed through the circuit, metal ions in the solution are attracted to the item. The result is a layer of metal on the item. Considerable skill is required to produce an evenly coated finished product. This process is analogous to a galvanic cell acting in reverse.

**Topic 1:  
Reactions in  
Aqueous Solutions**

---

**SPECIFIC LEARNING OUTCOME****C12-1-12:** Research practical applications of redox reactions.

*Examples: rocket fuels, fireworks, household bleach, photography, metal recovery from ores, steelmaking, aluminum recycling, fuel cells, batteries, tarnish removal, fruit clocks, forensic blood detection using luminol, chemiluminescence/bioluminescence, electrolytic cleaning, electrodeposition, photochemical etching, antioxidants/preservatives . . .*

*(continued)*

---

**■ Photochemical Etching**

In the photochemical etching process, “ultraviolet light is used to transfer a pattern onto a piece of metal. Then chemicals are applied to remove certain areas in the pattern, creating an intricate design on the metal” (Dingrando, et al., *Glencoe Chemistry: Matter and Change, Teacher Wraparound Edition* 641).

**■ Antioxidants/Preservatives**

Oxidation can cause the decay of food and other organic material (e.g., human skin). Antioxidants help reduce the decay of some essential amino acids and the loss of some vitamins. Antioxidants, such as vitamin C, vitamin E, BHT (butylated hydroxytoluene), BHA (butylated hydroxyanisole), sulphites, and sulphur dioxide, react more readily with oxygen than the food does. This keeps the food from spoiling.

**■ Heart Pacemakers**

Engineered in Canada by John Hopps in the 1940s, the pacemaker sends electrical impulses to the heart muscle to correct heartbeat irregularities. The pacemaker obtains its energy from a battery that lasts seven years.

**■ Corrosion Prevention**

Paint, or another protective coating, can protect steel structures from corrosion. Sacrificial anodes of magnesium, zinc, or other active metals are also used to prevent corrosion.

**SUGGESTIONS FOR ASSESSMENT**

---

**Research**

It may be beneficial to have students begin their research on the applications of redox chemistry now, and present or display their projects later during the study of Topic 6: Electrochemistry. For assessment suggestions, refer to Appendix 1.12B: Practical Applications of Redox Reactions (Sample Checklist and Assessment Rubric).

Students may wish to use a variety of presentation modes: models, posters, computer-generated materials, animation, video, murals, and so on.

### SKILLS AND ATTITUDES OUTCOMES

- C12-0-R1:** Synthesize information obtained from a variety of sources.  
Include: print and electronic sources, specialists, and other resource people
- C12-0-R5:** Communicate information in a variety of forms appropriate to the audience, purpose, and content.
- C12-0-C1:** Collaborate with others to achieve group goals and responsibilities.
- C12-0-C2:** Elicit, clarify, and respond to questions, ideas, and diverse points of view in discussions.
- C12-0-C3:** Evaluate individual and group processes.
- C12-0-T1:** Describe examples of the relationship between chemical principles and applications of chemistry.
- C12-0-T2:** Explain how scientific research and technology interact in the production and distribution of materials.
- C12-0-T3:** Provide examples of how chemical principles are applied in products and processes, in scientific studies, and in daily life.
- 

### LEARNING RESOURCES LINKS

---



*Glencoe Chemistry: Matter and Change* (Dingrando, et al.)  
Chapter 21: Electrochemistry, 662

*Glencoe Chemistry: Matter and Change, Teacher Wraparound Edition* (Dingrando, et al. 641, 684)

*Prentice Hall Chemistry* (Wilbraham, et al.)  
Chapter 21: Electrochemistry, 662

#### Appendices

Appendix 1.12A: Practical Applications of Redox Reactions (Research Report and Presentation)

Appendix 1.12B: Practical Applications of Redox Reactions (Sample Checklist and Assessment Rubric)

#### Selecting Learning Resources

For additional information on selecting learning resources for Grade 11 and Grade 12 Chemistry, see the Manitoba Education website at <[www.edu.gov.mb.ca/k12/learnres/bibliographies.html](http://www.edu.gov.mb.ca/k12/learnres/bibliographies.html)>.





# TOPIC 1:

## REACTIONS IN AQUEOUS SOLUTIONS

### APPENDICES

---

Appendix 1.1A:	Developing a Set of Solubility Rules: Lab Activity	3
Appendix 1.1B:	Developing a Set of Solubility Rules: Lab Activity (Teacher Notes)	4
Appendix 1.2:	Solubility Rules	7
Appendix 1.3:	Predicting Precipitation Reactions	8
Appendix 1.4:	Colour Chart for Ions in Aqueous Solutions	10
Appendix 1.5:	Identifying Unknown Solutions (Teacher Notes and Preparation Guide)	11
Appendix 1.6A:	Process Notes for Writing Net Ionic Equations (Teacher Notes)	13
Appendix 1.6B:	Process Notes for Writing Net Ionic Equations (BLM)	14
Appendix 1.7A:	Titration: Lab Activity	15
Appendix 1.7B:	Titration: Lab Activity (Teacher Notes)	18
Appendix 1.8:	Process Notes for Balancing Neutralization Reactions	20
Appendix 1.9A:	Test Tube Mystery: Lab Activity (Guidelines)	21
Appendix 1.9B:	Test Tube Mystery: Lab Activity (Preparation Guide)	23
Appendix 1.9C:	Test Tube Mystery: Lab Activity (Teacher Key 1)	25
Appendix 1.9D:	Test Tube Mystery: Lab Activity (Teacher Key 2)	26
Appendix 1.10A:	Compare and Contrast Oxidation and Reduction	28
Appendix 1.10B:	Compare and Contrast Oxidation and Reduction (Sample Response)	29
Appendix 1.11:	Oxidation Number Rules	30
Appendix 1.12A:	Practical Applications of Redox Reactions (Research Report and Presentation)	31
Appendix 1.12B:	Practical Applications of Redox Reactions (Sample Checklist and Assessment Rubric)	33



## Appendix 1.1A: Developing a Set of Solubility Rules: Lab Activity

### Purpose

In this lab activity, you will develop your own procedure to create a set of solubility rules. You will be provided with 0.1 mol/L solutions of various anions and cations so that you can observe whether precipitates are formed.

### Solutions

The solutions the class will use include the following:

#### ■ Set A

silver ions ( $\text{Ag}^+$ )  
barium ions ( $\text{Ba}^{2+}$ )  
sodium ions ( $\text{Na}^+$ )  
ammonium ions ( $\text{NH}_4^+$ )  
calcium ions ( $\text{Ca}^{2+}$ )  
chloride ions ( $\text{Cl}^-$ )  
carbonate ions ( $\text{CO}_3^{2-}$ )  
sulphate ions ( $\text{SO}_4^{2-}$ )  
nitrate ions ( $\text{NO}_3^-$ )  
phosphate ions ( $\text{PO}_4^{3-}$ )

#### ■ Set B

zinc ions ( $\text{Zn}^{2+}$ )  
iron ions ( $\text{Fe}^{3+}$ )  
sodium ions ( $\text{Na}^+$ )  
magnesium ions ( $\text{Mg}^{2+}$ )  
potassium ions ( $\text{K}^+$ )  
chloride ions ( $\text{Cl}^-$ )  
hydroxide ions ( $\text{OH}^-$ )  
bromide ions ( $\text{Br}^-$ )  
carbonate ions ( $\text{CO}_3^{2-}$ )  
acetate ions ( $\text{C}_2\text{H}_3\text{O}_2^-$ )

Before you begin mixing solutions, set up a grid to organize your observations.

### Follow-up Questions

1. Scientists have developed a set of solubility rules with respect to the solubility of anions with numerous cations.
  - a) List the cations that did not form any precipitates.
  - b) For each anion, list the cations with which it was insoluble (formed a precipitate).
2. List the set of solubility rules that you have developed.

## Appendix 1.1B: Developing a Set of Solubility Rules: Lab Activity (Teacher Notes)

---

### Introduction

Have student groups perform the lab activity using the solutions in either Set A or Set B below and then share their observations.

Where appropriate, 1.0 mol/L solutions can be prepared instead of 0.1 mol/L solutions. Involving students in the preparation of solutions is desirable. It may be clearer for students if the ions that participate in the reactions come from separate solutions. For instance, in Set A, a solution of 0.1 mol/L NaCl could be the source of  $\text{Na}^+$  ions, and 0.1 mol/L  $\text{Na}_2\text{CO}_3$  acts as the source of  $\text{CO}_3^{2-}$  ions. These solutions would replace the following solution in Set A below: 2 × 0.1 mol/L solutions of sodium carbonate ( $\text{Na}_2\text{CO}_3$ ) labelled  $\text{Na}^+$  and  $\text{CO}_3^{2-}$ . The  $\text{NH}_4\text{Cl}$  is used for the  $\text{NH}_4^+$  ions and the  $(\text{NH}_4)_2\text{SO}_4$  is used as the source for  $\text{SO}_4^{2-}$  ions. For Set B, NaCl can be used as a source for sodium ions, and KCl can be used as a source for potassium ions.

If this strategy is not followed, students will no doubt observe “anomalous” precipitates (discrepant events) that were unexpected, and may be difficult to explain. To avoid confusion, teachers are encouraged to proceed according to the level of difficulty desired for students’ explanations of results.

### Solutions

Prepare solution sets of 25 mL dropper bottles.

#### Set A

- 1 × 0.1 mol/L solution of silver nitrate ( $\text{AgNO}_3$ ) labelled  $\text{Ag}^+$
- 2 × 0.1 mol/L solutions of barium chloride ( $\text{BaCl}_2$ ) labelled  $\text{Ba}^{2+}$  and  $\text{Cl}^-$
- 2 × 0.1 mol/L solutions of sodium carbonate ( $\text{Na}_2\text{CO}_3$ ) labelled  $\text{Na}^+$  and  $\text{CO}_3^{2-}$
- 2 × 0.1 mol/L solutions of ammonium sulphate ( $(\text{NH}_4)_2\text{SO}_4$ ) labelled  $\text{NH}_4^+$  and  $\text{SO}_4^{2-}$
- 2 × 0.1 mol/L solutions of calcium nitrate ( $\text{Ca}(\text{NO}_3)_2$ ) labelled  $\text{Ca}^{2+}$  and  $\text{NO}_3^-$
- 1 × 0.1 mol/L solution of potassium phosphate ( $\text{K}_3\text{PO}_4$ ) labelled  $\text{PO}_4^{3-}$

#### Set B

- 1 × 0.1 mol/L solution of zinc acetate ( $\text{Zn}(\text{C}_2\text{H}_3\text{O}_2)_2$ ) labelled  $\text{Zn}^{2+}$
- 2 × 0.1 mol/L solutions of iron(III) chloride ( $\text{FeCl}_3$ ) labelled  $\text{Fe}^{3+}$  and  $\text{Cl}^-$
- 2 × 0.1 mol/L solutions of sodium hydroxide ( $\text{NaOH}$ ) labelled  $\text{Na}^+$  and  $\text{OH}^-$
- 1 × 0.1 mol/L solution of magnesium bromide ( $\text{MgBr}_2$ ) labelled  $\text{Mg}^{2+}$
- 1 × 0.1 mol/L solution of sodium bromide ( $\text{NaBr}$ ) labelled  $\text{Br}^-$
- 2 × 0.1 mol/L solutions of potassium carbonate ( $\text{K}_2\text{CO}_3$ ) labelled  $\text{K}^+$  and  $\text{CO}_3^{2-}$
- 1 × 0.1 mol/L solution of sodium acetate ( $\text{NaC}_2\text{H}_3\text{O}_2$ ) labelled  $\text{C}_2\text{H}_3\text{O}_2^-$

Appendix 1.1A: Developing a Set of Solubility Rules: Lab Activity (Teacher Notes)  
(continued)

Probable Results

Set A					
	$\text{Cl}^-$	$\text{CO}_3^{2-}$	$\text{SO}_4^{2-}$	$\text{NO}_3^-$	$\text{PO}_4^{3-}$
$\text{Ag}^+$	PPT	PPT	PPT	NP	PPT
$\text{Ba}^{2+}$	NP	PPT	PPT	NP	PPT
$\text{Na}^+$	NP	NP	NP	NP	NP
$\text{NH}_4^+$	NP	NP	NP	NP	NP
$\text{Ca}^{2+}$	NP	PPT	PPT	NP	PPT

PPT = precipitate; NP = no precipitate

1. a) The cations that did not form any precipitates were  $\text{Na}^+$  and  $\text{NH}_4^+$ .

b)  $\text{Cl}^-$  formed a precipitate with  $\text{Ag}^+$ .

$\text{CO}_3^{2-}$  formed a precipitate with  $\text{Ag}^+$ ,  $\text{Ba}^{2+}$ , and  $\text{Ca}^{2+}$ .

$\text{SO}_4^{2-}$  formed a precipitate with  $\text{Ag}^+$ ,  $\text{Ba}^{2+}$ , and  $\text{Ca}^{2+}$ .

**Note:**  $\text{Ag}_2\text{SO}_4$  is sparingly soluble, so students may or may not see a precipitate.

$\text{NO}_3^-$  did not form a precipitate with any of the cations.

$\text{PO}_4^{3-}$  formed a precipitate with  $\text{Ag}^+$ ,  $\text{Ba}^{2+}$ , and  $\text{Ca}^{2+}$ .

Appendix 1.1B: Developing a Set of Solubility Rules: Lab Activity (Teacher Notes)  
(continued)

Set B					
	Cl <sup>-</sup>	OH <sup>-</sup>	Br <sup>-</sup>	CO <sub>3</sub> <sup>2-</sup>	C <sub>2</sub> H <sub>3</sub> O <sub>2</sub> <sup>-</sup>
Zn <sup>2+</sup>	NP	PPT	NP	PPT	NP
Fe <sup>3+</sup>	NP	PPT	NP	NP	NP
Na <sup>+</sup>	NP	NP	NP	NP	NP
Mg <sup>2+</sup>	NP	PPT	NP	PPT	NP
K <sup>+</sup>	NP	NP	NP	NP	NP

- The cations that did not form any precipitates were Na<sup>+</sup> and K<sup>+</sup>.
  - Cl<sup>-</sup> did not form a precipitate with any of the cations.  
OH<sup>-</sup> formed a precipitate with Zn<sup>2+</sup>, Fe<sup>3+</sup> and Mg<sup>2+</sup>.  
Br<sup>-</sup> did not form a precipitate with any of the cations.  
CO<sub>3</sub><sup>2-</sup> formed a precipitate with Zn<sup>2+</sup> and Mg<sup>2+</sup>.  
C<sub>2</sub>H<sub>3</sub>O<sub>2</sub><sup>-</sup> did not form a precipitate with any of the cations.
- Solubility Rules
  - Most nitrate (NO<sub>3</sub><sup>-</sup>) salts are soluble.
  - Most salts containing the alkali metal ions (Li<sup>+</sup>, Na<sup>+</sup>, K<sup>+</sup>, Rb<sup>+</sup>, Cs<sup>+</sup>) and the ammonium ion (NH<sub>4</sub><sup>+</sup>) are soluble.
  - Most chloride (Cl<sup>-</sup>), bromide (Br<sup>-</sup>), and iodide (I<sup>-</sup>) salts are soluble. Notable exceptions are salts containing the ions Ag<sup>+</sup>, Pb<sup>2+</sup>, and Hg<sub>2</sub><sup>2+</sup>.
  - Most sulphate (SO<sub>4</sub><sup>2-</sup>) salts are soluble. Notable exceptions are BaSO<sub>4</sub>, PbSO<sub>4</sub>, HgSO<sub>4</sub> and CaSO<sub>4</sub>.
  - Most hydroxide (OH<sup>-</sup>) salts are only slightly soluble. The important soluble hydroxides are NaOH and KOH. The compounds Ba(OH)<sub>2</sub>, Sr(OH)<sub>2</sub>, and Ca(OH)<sub>2</sub> are marginally soluble.
  - Most sulphide (S<sup>2-</sup>), carbonate (CO<sub>3</sub><sup>2-</sup>), chromate (CrO<sub>4</sub><sup>2-</sup>), and phosphate (PO<sub>4</sub><sup>3-</sup>) salts are only slightly soluble.

## Appendix 1.2: Solubility Rules

Negative Ions	Positive Ions	Solubility
Essentially all	Alkali ions ( $\text{Li}^+$ , $\text{Na}^+$ , $\text{K}^+$ , $\text{Rb}^+$ , $\text{Cs}^+$ )	Soluble
Essentially all	Hydrogen ion $\text{H}^+_{(\text{aq})}$	Soluble
Essentially all	Ammonium ion ( $\text{NH}_4^+$ )	Soluble
Nitrate, $\text{NO}_3^-$	Essentially all	Soluble
Acetate, $\text{CH}_3\text{COO}^-$	Essentially all (except $\text{Ag}^+$ )	Soluble
Chloride, $\text{Cl}^-$ Bromide, $\text{Br}^-$ Iodide, $\text{I}^-$	$\text{Ag}^+$ , $\text{Pb}^{2+}$ , $\text{Hg}_2^{2+}$ , $\text{Cu}^+$ , $\text{Tl}^+$	Low solubility
	All others	Soluble
Sulphate, $\text{SO}_4^{2-}$	$\text{Ca}^{2+}$ , $\text{Sr}^{2+}$ , $\text{Ba}^{2+}$ , $\text{Pb}^{2+}$ , $\text{Ra}^{2+}$	Low solubility
	All others	Soluble
Sulphide, $\text{S}^{2-}$	Alkali ions, $\text{H}^+_{(\text{aq})}$ , $\text{NH}_4^+$ , $\text{Be}^{2+}$ , $\text{Mg}^{2+}$ , $\text{Ca}^{2+}$ , $\text{Sr}^{2+}$ , $\text{Ba}^{2+}$ , $\text{Ra}^{2+}$	Soluble
	All others	Low solubility
Hydroxide, $\text{OH}^-$	Alkali ions, $\text{H}^+_{(\text{aq})}$ , $\text{NH}_4^+$ , $\text{Sr}^{2+}$ , $\text{Ba}^{2+}$ , $\text{Ra}^{2+}$ , $\text{Tl}^{2+}$	Soluble
	All others	Low solubility
Phosphate, $\text{PO}_4^{3-}$ Carbonate, $\text{CO}_3^{2-}$ Sulphite, $\text{SO}_3^{2-}$	Alkali ions, $\text{H}^+_{(\text{aq})}$ , $\text{NH}_4^+$	Soluble
	All others	Low solubility
Chromate, $\text{CrO}_4^{2-}$	$\text{Ba}^{2+}$ , $\text{Sr}^{2+}$ , $\text{Pb}^{2+}$ , $\text{Ag}^+$	Low solubility
	All others	Soluble

## Appendix 1.3: Predicting Precipitation Reactions

Use a solubility rules table to predict precipitation reactions.

- Predict the products of the reactions in the following examples.
- Write a balanced molecular equation and check the table for the solubility of the products.
- Write a total ionic equation.
- Write a net ionic equation.

### Example 1

$\text{AlCl}_3$  reacts with  $\text{KOH}$

- $\text{Al}^{3+}$  combines with  $\text{OH}^-$  to form  $\text{Al}(\text{OH})_3$ , and  $\text{K}^+$  combines with  $\text{Cl}^-$  to form  $\text{KCl}$ .
- The balanced molecular equation will be

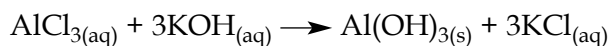

Notice from the solubility table that the  $\text{Al}^{3+}$  ion is insoluble with the  $\text{OH}^-$  ion, thus forming a precipitate.

- Compounds that are written as aqueous are broken down to their respective cations and anions. Solids are written in molecular form.

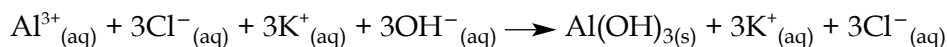

- Ions that are common to both sides of the reaction are called spectator ions. These ions are cancelled when writing the net ionic equation.

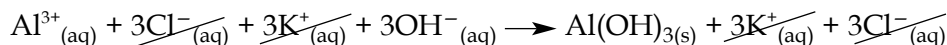

The net ionic equation would be

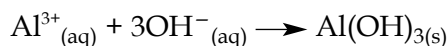



## Appendix 1.3: Predicting Precipitation Reactions (continued)

**Example 2**

$\text{AgNO}_3$  reacts with  $\text{CaI}_2$

a)  $\text{Ag}^+$  combines with  $\text{I}^-$  to form  $\text{AgI}$ , and  $\text{Ca}^{2+}$  combines with  $\text{NO}_3^-$  to form  $\text{Ca}(\text{NO}_3)_2$ .

b) The balanced molecular equation will be

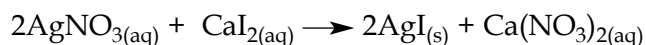

Notice from the solubility table that the  $\text{Ag}^+$  ion is insoluble with the  $\text{I}^-$  ion, thus forming a precipitate.

c) Compounds that are written as aqueous are broken down to their respective cations and anions. Solids are written in molecular form.

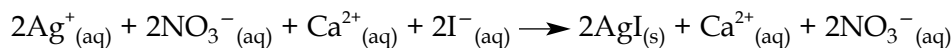

d) Ions that are common to both sides of the reaction are called spectator ions. These ions are cancelled when writing the net ionic equation.

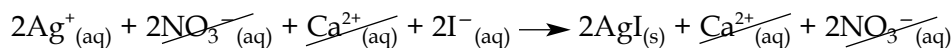

The net ionic equation would be

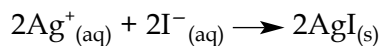

**Appendix 1.4: Colour Chart for Ions in Aqueous Solutions**

Ion	Symbol	Colour
Chrome(II)	$\text{Cr}^{2+}$	Blue
Chrome(III)	$\text{Cr}^{3+}$	Green
Cobalt(II)	$\text{Co}^{2+}$	Pink
Chromate	$\text{CrO}_4^{2-}$	Yellow
Dichromate	$\text{Cr}_2\text{O}_7^{2-}$	Orange
Copper(I)	$\text{Cu}^+$	Green
Copper(II)	$\text{Cu}^{2+}$	Blue
Iron(II)	$\text{Fe}^{2+}$	Green
Iron(III)	$\text{Fe}^{3+}$	Pale yellow
Manganese(II)	$\text{Mn}^{2+}$	Pink
Permanganate	$\text{MnO}_4^-$	Purple
Nickel(II)	$\text{Ni}^{2+}$	Green

## Appendix 1.5: Identifying Unknown Solutions (Teacher Notes and Preparation Guide)

### Purpose

Present student groups with four unknown solutions. Their job will be to identify each unknown solution using only a spot plate, a stir stick, a chart showing the colour of ions in aqueous solutions, a table of solubility rules, and the solutions themselves.

### Solutions

The sets of solutions that students will use could include 0.1 mol/L solutions of the following:

Set 1:  $\text{Ba}(\text{NO}_3)_2$ ,  $\text{NaOH}$ ,  $\text{Na}_2\text{CO}_3$ ,  $\text{CuSO}_4$

Set 2:  $\text{Co}(\text{NO}_3)_2$ ,  $\text{Na}_3\text{PO}_4$ ,  $\text{Na}_2\text{SO}_4$ ,  $\text{AgNO}_3$

Set 3:  $\text{Cr}_2(\text{SO}_4)_3$ ,  $\text{MnSO}_4$ ,  $\text{Ba}(\text{NO}_3)_2$ ,  $\text{Zn}(\text{NO}_3)_2$

Set 4:  $\text{Fe}(\text{NO}_3)_3$ ,  $\text{KI}$ ,  $\text{Pb}(\text{NO}_3)_2$ ,  $\text{NaOH}$

Set 5:  $\text{NiSO}_4$ ,  $\text{Na}_2\text{CO}_3$ ,  $\text{MnSO}_4$ ,  $\text{NaCl}$

Set 6:  $\text{CuSO}_4$ ,  $\text{NaCl}$ ,  $\text{Na}_3\text{PO}_4$ ,  $\text{Zn}(\text{NO}_3)_2$

### Questions

Students must correctly identify the four solutions and explain how they identified each of the solutions using the solubility rules.

1. Using a chart that shows the colour of common ions in aqueous solutions, can you identify any of your unknowns based on this information? Explain.
2. Which solutions that you mixed formed a precipitate? Can you identify any of the unknown solutions based on this result? Explain.
3. Are there any reactions that have no precipitate formation? Can you identify any of the unknown solutions based on this result? Explain.

### Preparation Guide

Prepare 0.1 mol/L solutions of each of the following.

#### Set 1

Solution 1: 2.613 g of  $\text{Ba}(\text{NO}_3)_2$  in 100 mL of solution

Solution 2: 0.40 g of  $\text{NaOH}$  in 100 mL of solution

Solution 3: 1.06 g of  $\text{Na}_2\text{CO}_3$  in 100 mL of solution

Solution 4: 2.50 g of  $\text{CuSO}_4 \cdot 5\text{H}_2\text{O}$  in 100 mL of solution

**Appendix 1.5: Identifying Unknown Solutions (Teacher Notes and Preparation Guide) (continued)**

---

**Set 2**

Solution 1: 2.91 g of  $\text{Co}(\text{NO}_3)_2 \cdot 6\text{H}_2\text{O}$  in 100 mL of solution

Solution 2: 2.90 g of  $\text{Na}_3\text{PO}_4 \cdot 7\text{H}_2\text{O}$  in 100 mL of solution

Solution 3: 1.421 g of  $\text{Na}_2\text{SO}_4$  in 100 mL of solution

Solution 4: 1.699 g of  $\text{AgNO}_3$  in 100 mL of solution

**Set 3**

Solution 1: 3.60 g of  $\text{Cr}_2(\text{SO}_4)_3$  in 100 mL of solution

Solution 2: 1.69 g of  $\text{MnSO}_4 \cdot \text{H}_2\text{O}$  in 100 mL of solution

Solution 3: 2.613 g of  $\text{Ba}(\text{NO}_3)_2$  in 100 mL of solution

Solution 4: 2.97 g of  $\text{Zn}(\text{NO}_3)_2 \cdot 6\text{H}_2\text{O}$  in 100 mL of solution

**Set 4**

Solution 1: 4.04 g of  $\text{Fe}(\text{NO}_3)_3 \cdot 9\text{H}_2\text{O}$  in 100 mL of solution

Solution 2: 1.66 g of  $\text{KI}$  in 100 mL of solution

Solution 3: 3.312 g of  $\text{Pb}(\text{NO}_3)_2$  in 100 mL of solution

Solution 4: 0.40 g of  $\text{NaOH}$  in 100 mL of solution

**Set 5**

Solution 1: 2.63 g of  $\text{NiSO}_4 \cdot 6\text{H}_2\text{O}$  in 100 mL of solution

Solution 2: 1.06 g of  $\text{Na}_2\text{CO}_3$  in 100 mL of solution

Solution 3: 1.69 g of  $\text{MnSO}_4 \cdot \text{H}_2\text{O}$  in 100 mL of solution

Solution 4: 0.584 g of  $\text{NaCl}$  in 100 mL of solution

**Set 6**

Solution 1: 2.50 g of  $\text{CuSO}_4 \cdot 5\text{H}_2\text{O}$  in 100 mL of solution

Solution 2: 0.584 g of  $\text{NaCl}$  in 100 mL of solution

Solution 3: 2.90 g of  $\text{Na}_3\text{PO}_4 \cdot 7\text{H}_2\text{O}$  in 100 mL of solution

Solution 4: 2.97 g of  $\text{Zn}(\text{NO}_3)_2 \cdot 6\text{H}_2\text{O}$  in 100 mL of solution

## Appendix 1.6A: Process Notes for Writing Net Ionic Equations (Teacher Notes)

Solve the problem, showing all steps.	Use words to describe each step of the solution.
$\text{Na}_2\text{S} + \text{FeSO}_4 \rightarrow \text{Na}_2\text{SO}_4 + \text{FeS}$	Step 1: Predict the products of the double displacement reaction and ensure that the equation is balanced.
$\text{Na}_2\text{S}_{(\text{aq})} + \text{FeSO}_{4(\text{aq})} \rightarrow$ $\text{Na}_2\text{SO}_{4(\text{aq})} + \text{FeS}_{(\text{s})}$	Step 2: Use (aq) and (s) to identify each species as being soluble or slightly soluble (i.e., write the molecular equation).
$2\text{Na}^+_{(\text{aq})} + \text{S}^{2-}_{(\text{aq})} + \text{Fe}^{2+}_{(\text{aq})} + \text{SO}_4^{-}_{(\text{aq})} \rightarrow$ $2\text{Na}^+_{(\text{aq})} + \text{SO}_4^{2-}_{(\text{aq})} + \text{FeS}_{(\text{s})}$	Step 3: Write the ionic equation by breaking up soluble species into their ions.
$\cancel{2\text{Na}^+_{(\text{aq})}} + \text{S}^{2-}_{(\text{aq})} + \text{Fe}^{2+}_{(\text{aq})} + \cancel{\text{SO}_4^{-}_{(\text{aq})}} \rightarrow$ $\cancel{2\text{Na}^+_{(\text{aq})}} + \cancel{\text{SO}_4^{2-}_{(\text{aq})}} + \text{FeS}_{(\text{s})}$	Step 4: Cancel out all spectator ions and rewrite the equation.
$\text{S}^{2-}_{(\text{aq})} + \text{Fe}^{2+}_{(\text{aq})} \rightarrow \text{FeS}_{(\text{s})}$	This gives the net ionic equation.

**Appendix 1.6B: Process Notes for Writing Net Ionic Equations (BLM)**

<b>Solve the problem, showing all steps</b>	<b>Use words to describe each step of the solution process.</b>
$\text{BaCl}_2 + \text{Na}(\text{PO}_4)_3 \rightarrow$	<p>Step 1: Predict the products of the double displacement reaction and ensure that the equation is balanced.</p> <p>Step 2: Use (aq) and (s) to identify each species as being soluble or slightly soluble (i.e., write the molecular equation).</p> <p>Step 3: Write the ionic equation by breaking up soluble species into their ions.</p> <p>Step 4: Cancel out all spectator ions and rewrite the equation.</p> <p>This gives the net ionic equation.</p>

## Appendix 1.7A: Titration: Lab Activity

### Purpose

Titration is a procedure that is usually used to determine the unknown concentrations of substances. In this lab activity, you will add drops of a known concentration of sodium hydroxide to a beaker containing a known concentration of sulphuric acid until neutralization occurs. The number of moles of each reactant can then be calculated from the volumes present, so that their ratio can be compared to the ratio of coefficients in the balanced equation.

### Materials

- 50 mL beaker
- three micropipettes
- phenolphthalein indicator
- 10 mL graduated cylinder
- distilled water
- 0.1 mol/L sodium hydroxide (NaOH)
- 0.1 mol/L sulphuric acid (H<sub>2</sub>SO<sub>4</sub>)

### Procedure

1. Using the 10 mL graduated cylinder and a micropipette, count and record the number of drops required to obtain 1.0 mL of distilled water. Perform this process a total of three times.  
**Note:** For the best, most reproducible results, hold the micropipette vertically, and squeeze the bulb slowly and gently. Avoid introducing air bubbles into the stem of the pipette, as they will result in half or quarter drops.
2. Add 5 mL of distilled water and one drop of phenolphthalein indicator to a 50 mL beaker. Swirl the beaker well.
3. Using a second micropipette (to avoid contamination of the solutions), add 20 drops of 0.1 mol/L H<sub>2</sub>SO<sub>4</sub> to the beaker. Swirl the solution carefully.
4. Using a third micropipette, add the 0.1 mol/L NaOH drop by drop, until the addition of one drop of the base permanently changes the colour of the solution. Be sure to swirl the beaker gently after each drop is added. Record the number of drops required to reach the endpoint of the titration.  
**Note:** The endpoint of the titration occurs when one drop of an acid or a base permanently changes the colour of the indicator used in the titration.
5. Rinse the contents of the beaker down the sink with plenty of water (the final rinse should be with distilled water), and perform steps 2 through 4 a total of three times.

## Appendix 1.7A: Titration: Lab Activity (continued)

**Note:** The trials should agree with one another to within one drop. If you make a mistake, miss the endpoint, or lose count of the drops, perform another trial. Do not erase the results, but make note of what went wrong.

**Qualitative Observations**

- Describe each solution before reaction occurs.
- Describe the solution after adding the drops of phenolphthalein.

**Quantitative Data Tables**

Trial	Drops of Water in 1.0 mL
1	
2	
3	
Average	

Volume of Water Used (mL)	Drops of Sulphuric Acid	Volume of Sulphuric Acid (mL)	Drops of Sodium Hydroxide	Volume of Sodium Hydroxide (mL)
5	20			
5	20			
5	20			
Average				



---

**Appendix 1.7A: Titration: Lab Activity** *(continued)*

---

**Calculations**

1. Write a balanced molecular equation for the reaction.
2. Draw a particulate representation of the balanced reaction.
3. Calculate the average number of drops required to obtain 1.0 mL of distilled water.
4. Using the data obtained in step 2 of the procedure, calculate the volume of NaOH added in each trial.
5. Calculate the average number of moles of NaOH required to neutralize the sample of  $\text{H}_2\text{SO}_4$ .
6. Using the data obtained in step 2, calculate the volume of  $\text{H}_2\text{SO}_4$  added in each trial.
7. Using your balanced equation, determine the average number of moles present in the sample of  $\text{H}_2\text{SO}_4$ .
8. Use the coefficients in the balanced equation to determine the ratio of moles between the sodium hydroxide and the sulphuric acid.
9. Use the number of moles obtained in steps 4 and 5 of the procedure to determine the ratio of moles between the sodium hydroxide and the sulphuric acid.

**Conclusion**

State the stoichiometric relationship between the sodium hydroxide and the sulphuric acid.

**Questions**

1. a) Write a balanced molecular equation for the reaction between barium hydroxide and sulphuric acid.  
b) Use the coefficients in the balanced equation to calculate the volume of barium hydroxide required to react with 20 mL of sulphuric acid.
2. a) Write a balanced molecular equation for the reaction between aluminum hydroxide and sulphuric acid.  
b) Use the coefficients in the balanced equation to calculate the volume of aluminum hydroxide required to react with 30 mL of sulphuric acid.

**Sources of Error**

What possible errors could have occurred in your lab activity?

## Appendix 1.7B: Titration: Lab Activity (Teacher Notes)

### Purpose

To demonstrate the stoichiometry of a neutralization reaction between a strong acid and a strong base.

### Qualitative Observations

Distilled water: clear, colourless liquid

Sulphuric acid: clear, colourless liquid

Sodium hydroxide: clear, colourless liquid

Phenolphthalein: clear, colourless liquid

### Quantitative Data Tables

Trial	Drops of Water in 1.0 mL
1	23
2	24
3	23
Average	23

Volume of Water Used (mL)	Drops of Sulphuric Acid	Volume of Sulphuric Acid (mL)	Drops of Sodium Hydroxide	Volume of Sodium Hydroxide (mL)
5	20	0.858	69	2.96
5	20	0.858	68	2.92
5	20	0.858	70	3.00
Average	20	0.858	69	2.96

## Appendix 1.7B: Titration: Lab Activity (Teacher Notes) (continued)

## Calculations

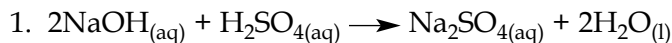

2. Molecule size is not a true representation of the actual size of the compound.

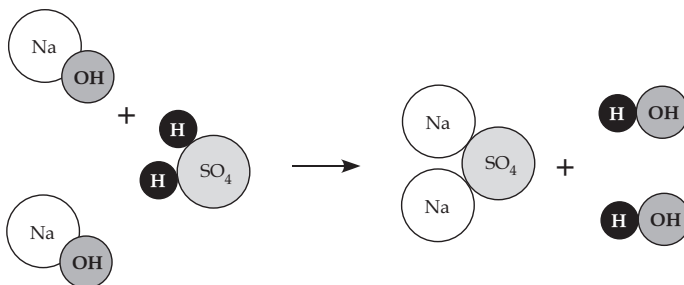

3.  $(23 + 24 + 23)/3 = 23.3$  drops
4. volume NaOH =  $(1 \text{ mL}/23.3 \text{ drops}) \times 69 \text{ drops} = 2.96 \text{ mL}$  of NaOH
5. moles NaOH =  $0.10 \text{ mole/L} \times 2.96 \times 10^{-3} \text{ L} = 0.000296$  moles NaOH
6. volume  $\text{H}_2\text{SO}_4$  =  $(1 \text{ mL}/23.3 \text{ drops}) \times 20 \text{ drops} = 0.858 \text{ mL}$  of  $\text{H}_2\text{SO}_4$
7. moles  $\text{H}_2\text{SO}_4$  =  $0.10 \text{ mole/L} \times 0.858 \times 10^{-3} \text{ L} = 0.0000858$  moles  $\text{H}_2\text{SO}_4$
8. coefficient NaOH/coefficient  $\text{H}_2\text{SO}_4$  =  $2/1 = 2$
9. moles NaOH/moles  $\text{H}_2\text{SO}_4$  =  $0.000296/0.0000858 = 3.45$

## Conclusion

Answers will vary. For example, the stoichiometric relationship between the sodium hydroxide and the sulphuric acid in the balanced equation is 2 to 1, while the experimental relationship is 3.45 to 1.

## Questions

1. a)  $\text{Ba}(\text{OH})_{2(\text{aq})} + \text{H}_2\text{SO}_{4(\text{aq})} \longrightarrow \text{BaSO}_{4(\text{aq})} + 2\text{H}_2\text{O}_{(\text{l})}$   
 b) The volume of barium hydroxide required to react with 20 mL of sulphuric acid is 20 mL.
2. a)  $2\text{Al}(\text{OH})_{3(\text{aq})} + 3\text{H}_2\text{SO}_{4(\text{aq})} \longrightarrow \text{Al}_2(\text{SO}_4)_{3(\text{aq})} + 6\text{H}_2\text{O}_{(\text{l})}$   
 b) The volume of aluminum hydroxide required to react with 30 mL of sulphuric acid is 20 mL.

## Sources of Error

Sources of error could include calibration of the micropipette and graduated cylinder, as well as the accuracy of the concentrations of the solutions used.

## Appendix 1.8: Process Notes for Balancing Neutralization Reactions

Solve the problem, showing all the steps.	Use words to describe each step of the solution process.
$\text{H}_2\text{SO}_4 + \text{NaOH} \rightarrow \text{Na}_2\text{SO}_4 + \text{H}_2\text{O}$	Step 1: Predict the products of the neutralization reaction. Remember that a salt and water are formed.
$\text{H}_2\text{SO}_{4(\text{aq})} + 2\text{NaOH}(\text{aq}) \rightarrow \text{Na}_2\text{SO}_{4(\text{aq})} + 2\text{H}_2\text{O}(\text{l})$	Step 2: Ensure that the equation is balanced. Use (aq) and (l) to identify each species as being soluble or slightly soluble (i.e., write the molecular equation).
$2\text{H}^+_{(\text{aq})} + \text{SO}_4^{2-}_{(\text{aq})} + 2\text{Na}^+_{(\text{aq})} + 2\text{OH}^-_{(\text{aq})} \rightarrow 2\text{Na}^+_{(\text{aq})} + \text{SO}_4^{2-}_{(\text{aq})} + 2\text{H}_2\text{O}(\text{l})$	Step 3: Write a total ionic equation, showing all ions that are in solution.
$\cancel{2\text{H}^+_{(\text{aq})}} + \cancel{\text{SO}_4^{2-}_{(\text{aq})}} + \cancel{2\text{Na}^+_{(\text{aq})}} + \cancel{2\text{OH}^-_{(\text{aq})}} \rightarrow \cancel{2\text{Na}^+_{(\text{aq})}} + \cancel{\text{SO}_4^{2-}_{(\text{aq})}} + 2\text{H}_2\text{O}(\text{l})$	Step 4: Cancel the spectator ions.
$\text{H}^+_{(\text{aq})} + \text{OH}^-_{(\text{aq})} \rightarrow \text{H}_2\text{O}(\text{l})$	Step 5: Write the net ionic equation.

## Appendix 1.9A: Test Tube Mystery: Lab Activity (Guidelines)

### Purpose

Chemists, like detectives, attempt to identify unknowns through a process of careful and creative analysis. This usually involves observing the colours, odours, and reactions of unknown substances and comparing them with those of known substances. In this experiment, you will try to identify 12 different chemical compounds by reacting them with each other, observing the results, and comparing the results with the known characteristics of some common chemicals.

### Chemical Compounds

The 12 chemicals used in this experiment are listed below (in no particular order):

- potassium chromate ( $K_2CrO_4$ )
- aluminum chloride ( $AlCl_3$ )
- sodium carbonate ( $Na_2CO_3$ )
- sodium acetate ( $NaCH_3COO$ )
- hydrochloric acid (HCl)
- sodium hydroxide (NaOH)
- ammonium hydroxide ( $NH_4OH$ )
- iron(III) nitrate ( $Fe(NO_3)_3$ )
- silver nitrate ( $AgNO_3$ )
- copper(II) sulphate ( $CuSO_4$ )
- nickel(II) chloride ( $NiCl_2$ )
- lead(II) nitrate ( $Pb(NO_3)_2$ )

### Research and Plan

Before starting the lab activity, you will have to do extensive research on the characteristic colours of the solutions, any distinguishing odours, their flame-test colours, and the colours of any precipitates that may be created through the combination of each different species. Your written plan must include a data table grid that includes each species, the solution and flame-test colours, the colours of potential precipitates, and any other information that you think will help to identify your unknowns.

## Appendix 1.9A: Test Tube Mystery: Lab Activity (Guidelines) *(continued)*

---

### Materials

On the day of the lab activity, you will be provided with the following materials:

- 12 test tubes containing 8 mL each of different solutions
- well plates
- stir sticks
- cotton swabs/flame-test wires/moist wooden splints
- Bunsen burners
- matches
- litmus paper
- 10 micropipettes
- gloves
- distilled water

Avoid running out of your samples, as you will not be provided with any more. Do not assume that solution sets other groups are using are numbered in the same way – they are not!

### Lab Write-up

After recording all your observations in the lab activity, you will attempt to identify each of the unknowns. A formal lab write-up must include a logical explanation of how you determined the identity of each test tube. This will include net ionic equations for any precipitates you saw.

### Caution

All solutions must be treated as if they were poisonous and corrosive. Avoid inhaling any fumes. Some reactions may occur very quickly, while others will occur more slowly. Observe each reaction for at least two minutes before disposing of the products. Gas evolution (bubbling) will be immediate. Rinse off your stir stick after each use. As time will be limited, use your time wisely.

**Appendix 1.9B: Test Tube Mystery: Lab Activity (Preparation Guide)**

Teachers can prepare the solutions for this lab activity in advance or have students prepare them. Prepare a solution, given the amount of solute (in grams) and the volume of solution (in millilitres), and determine the concentration in moles/litre.

**Materials**

- well plates
- stir sticks
- cotton swabs/flame-test wires/moist wooden splints
- Bunsen burners
- matches
- litmus paper
- micropipettes (10 per group)
- gloves
- distilled water
- test tube rack
- test tubes (12 × 10/group = 120 test tubes)
- test tube stoppers or plastic wrap to cover the test tubes
- 100 mL solutions of the following 12 solutions:
  - 0.2 mol/L  $K_2CrO_4$  – to prepare, dissolve 3.88 g of  $K_2CrO_4$  in 100 mL of distilled water
  - 1.0 mol/L  $AlCl_3 \cdot 6H_2O$  – dissolve 24.14 g of  $AlCl_3$  in 100 mL of distilled water
  - 1.0 mol/L  $Na_2CO_3$  – dissolve 10.6 g of  $Na_2CO_3$  in 100 mL of distilled water
  - 1.0 mol/L  $NaCH_3COO \cdot 3H_2O$  – dissolve 13.61 g of  $NaCH_3COO$  in 100 mL of distilled water
  - 6.0 mol/L  $HCl$  – mix 49.6 mL in 100 mL of distilled water
  - 6.0 mol/L  $NaOH$  – dissolve 24.0 g of  $NaOH$  in 100 mL of distilled water
  - 6.0 mol/L  $NH_4OH$  – mix 40.5 mL in 100 mL of distilled water
  - 0.1 mol/L  $Fe(NO_3)_3 \cdot 9H_2O$  – dissolve 4.04 g of  $Fe(NO_3)_3 \cdot 9H_2O$  in 100 mL of distilled water
  - 0.1 mol/L  $AgNO_3$  – dissolve 1.70 g of  $AgNO_3$  in 100 mL of distilled water
  - 0.1 mol/L  $CuSO_4$  – dissolve 2.50 g of  $CuSO_4 \cdot 5H_2O$  in 100 mL of distilled water
  - 0.1 mol/L  $NiCl_2 \cdot 6H_2O$  – dissolve 2.38 g of  $NiCl_2$  in 100 mL of distilled water
  - 0.1 mol/L  $Pb(NO_3)_2$  – dissolve 3.31 g of  $Pb(NO_3)_2$  in 100 mL of distilled water

## Appendix 1.9B: Test Tube Mystery: Lab Activity (Preparation Guide) (continued)

100 mL solutions should be prepared in advance of the lab activity.

Test tubes can be pre-labelled with the information, set 1, test tube 1, and so on.

Students are given an 8 to 10 mL sample of each solution (12 different test tubes) that are contained in a test tube rack.

A suggested teacher key is given for setting up each set of test tubes.

## Solution Set Key

Substance	Group 1 and Group 9	Group 2 and Group 10	Group 3 and Group 6	Group 4 and Group 7	Group 5 and Group 8
$K_2CrO_4$	3	1	2	3	4
$AlCl_3$	5	5	6	7	8
$Na_2CO_3$	6	9	10	11	12
$NaCH_3COO$	1	4	1	2	3
HCl	11	8	5	6	7
NaOH	4	12	9	10	11
$NH_4OH$	7	3	4	1	2
$Fe(NO_3)_3$	10	7	8	5	6
$AgNO_3$	2	11	12	9	10
$CuSO_4$	8	2	3	4	1
$NiCl_2$	12	6	7	8	5
$Pb(NO_3)_2$	9	10	11	12	9



## Appendix 1.9C: Test Tube Mystery: Lab Activity (Teacher Key 1)

Example of what students could have prepared before doing the lab activity.

	Kr <sub>2</sub> CrO <sub>4</sub>	AlCl <sub>3</sub>	Na <sub>2</sub> CO <sub>3</sub>	NaCH <sub>3</sub> COO	HCl	NaOH	NH <sub>4</sub> OH	Fe(NO <sub>3</sub> ) <sub>3</sub>	AgNO <sub>3</sub>	CuSO <sub>4</sub>	NiCl <sub>2</sub>	Pb(NO <sub>3</sub> ) <sub>2</sub>
Kr <sub>2</sub> CrO <sub>4</sub>		NP	NP	NP	NP	NP	NP	NP	Ag <sub>2</sub> CrO <sub>4</sub>	NP	NP	PbCrO <sub>4</sub>
AlCl <sub>3</sub>			Al <sub>2</sub> (CO <sub>3</sub> ) <sub>3</sub>	NP	NP	Al(OH) <sub>3</sub>	Al(OH) <sub>3</sub>	NP	AgCl	NP	N	PbCl <sub>2</sub>
Na <sub>2</sub> CO <sub>3</sub>				NP	gas	NP	NP	Fe <sub>2</sub> (CO <sub>3</sub> ) <sub>3</sub>	AgCO <sub>3</sub>	CuCO <sub>3</sub>	NiCO <sub>3</sub>	PbCO <sub>3</sub>
NaCH <sub>3</sub> COO					NP	NP	NP	NP	AgCH <sub>3</sub> COO	NP	NP	NP
HCl						NP	NP	NP	AgCl	NP	NP	PbCl <sub>2</sub>
NaOH							NP	Fe <sub>2</sub> (OH) <sub>3</sub>	AgOH	Cu(OH) <sub>2</sub>	Ni(OH) <sub>2</sub>	Pb(OH) <sub>2</sub>
NH <sub>4</sub> OH								Fe <sub>2</sub> (OH) <sub>3</sub>	AgOH	Cu(OH) <sub>2</sub>	Ni(OH) <sub>2</sub>	Pb(OH) <sub>2</sub>
Fe(NO <sub>3</sub> ) <sub>3</sub>									NP	NP	NP	NP
AgNO <sub>3</sub>										Ag <sub>2</sub> SO <sub>4</sub>	AgCl	NP
CuSO <sub>4</sub>											NP	PbSO <sub>4</sub>
NiCl <sub>2</sub>												PbCl <sub>2</sub>
Pb(NO <sub>3</sub> ) <sub>2</sub>												

NP = no precipitate

## Appendix 1.9D: Test Tube Mystery: Lab Activity (Teacher Key 2)

Substance	Identifying Colour/ Colour of Solution	Colour in Litmus Paper	Flame-Test Colour	Reacts with	To Make	Colour of Precipitate
$K_2CrO_4$	Yellow	Blue	Violet	$AgNO_3$ $Pb(NO_3)_2$	$Ag_2CrO_4$ $PbCrO_4$	Brick red Yellow
$AlCl_3$		Neutral		$Na_2CO_3$ NaOH $AgNO_3$ $Pb(NO_3)_2$	$Al_2(CO_3)_3$ $Al(OH)_3$ AgCl $PbCl_2$	White White White* Yellow
$Na_2CO_3$		Blue	Yellow	HCl $Fe(NO_3)_3$ $AgNO_3$ $CuSO_4$ $NiCl_2$ $Pb(NO_3)_2$ $AlCl_3$	bubbles $Fe(CO_3)_3$ $AgCO_3$ $CuCO_3$ $NiCO_3$ $PbCO_3$ $Al_2(CO_3)_3$	Bubbles White White* White White White White
$NaCH_3COO$		Blue	Yellow	$AgNO_3$	$AgCH_3COO$	White*
HCl		Pink		$AgNO_3$ $Pb(NO_3)_2$ $Na_2CO_3$	AgCl $PbCl_2$ Bubbles	White* Yellow Bubbles
NaOH		Blue		$Fe(NO_3)_3$ $AgNO_3$ $CuSO_4$ $NiCl_2$ $Pb(NO_3)_2$ $AlCl_3$	$Fe(OH)_3$ AgOH $Cu(OH)_2$ $Ni(OH)_2$ $Pb(OH)_2$ $Al(OH)_3$	White Brown* White White White White
$NH_4OH$	Strong odour	Blue		$Fe(NO_3)_3$ $AgNO_3$ $CuSO_4$ $NiCl_2$ $Pb(NO_3)_2$ $AlCl_3$	$Fe(OH)_3$ AgOH $Cu(OH)_2$ $Ni(OH)_2$ $Pb(OH)_2$ $Al(OH)_3$	White Brown* White White White White
$Fe(NO_3)_3$	Pale yellow	Neutral		$Na_2CO_3$ NaOH	$Fe_2(CO_3)_3$ $Fe(OH)_3$	White White/Brown

\* Most Ag precipitates start out a white to greyish-white colour, but turn purple/brown/black over time.

*continued*

## Appendix 1.9D: Test Tube Mystery: Lab Activity (Teacher Key 2) (continued)

Substance	Identifying Colour/ Colour of Solution	Colour in Litmus Paper	Flame-Test Colour	Reacts with	To Make	Colour of Precipitate
AgNO <sub>3</sub>		Neutral		NiCl <sub>2</sub> K <sub>2</sub> CrO <sub>4</sub> AlCl <sub>3</sub> Na <sub>2</sub> CO <sub>3</sub> NaCH <sub>3</sub> COO HCl NaOH CuSO <sub>4</sub>	AgCl Ag <sub>2</sub> CrO <sub>4</sub> AgCl Ag <sub>2</sub> CO <sub>3</sub> AgCH <sub>3</sub> COO AgCl AgOH Ag <sub>2</sub> SO <sub>4</sub>	White* Brick red White* White* White* White* Brown White*
CuSO <sub>4</sub>	Blue	Neutral	Bluish-green	Pb(NO <sub>3</sub> ) <sub>2</sub> Na <sub>2</sub> CO <sub>3</sub> NaOH	PbSO <sub>4</sub> CuCO <sub>3</sub> Cu(OH) <sub>2</sub>	White White White
NiCl <sub>2</sub>	Green/ Green-blue	Neutral		Pb(NO <sub>3</sub> ) <sub>2</sub> Na <sub>2</sub> CO <sub>3</sub> NaOH AgNO <sub>3</sub>	PbCl <sub>2</sub> NiCO <sub>3</sub> Ni(OH) <sub>2</sub> AgCl	Yellow White White White*
Pb(NO <sub>3</sub> ) <sub>2</sub>		Neutral	Bluish-white	K <sub>2</sub> CrO <sub>4</sub> AlCl <sub>3</sub> Na <sub>2</sub> CO <sub>3</sub> HCl NaOH CuSO <sub>4</sub> NiCl <sub>2</sub>	PbCrO <sub>4</sub> PbCl <sub>2</sub> PbCO <sub>3</sub> PbCl <sub>2</sub> Pb(OH) <sub>2</sub> PbSO <sub>4</sub> PbCl <sub>2</sub>	Yellow Yellow White Yellow White White White Yellow

\*Most Ag precipitates start out a white to greyish-white colour, but turn purple/brown/black over time.

## Appendix 1.10A: Compare and Contrast Oxidation and Reduction

Oxidation	Reduction
<p>Historical Definition:</p>   <p><i>Example:</i></p>	<p>Historical Definition:</p>   <p><i>Example:</i></p>
<p>Present Definition:</p>   <p><i>Example:</i></p>	<p>Present Definition:</p>   <p><i>Example:</i></p>
<p>Mnemonic Device:</p>   	<p>Mnemonic Device:</p>   
<p>When Balancing a Redox Reaction:</p> <p>One substance is _____</p> <p>and it is also the _____ agent.</p> <p>Its oxidation number _____ .</p>	<p>When Balancing a Redox Reaction:</p> <p>One substance is _____</p> <p>and it is also the _____ agent.</p> <p>Its oxidation number _____ .</p>

## Appendix 1.10B: Compare and Contrast Oxidation and Reduction (Sample Response)

Oxidation	Reduction
<p>Historical Definition:</p> <p>Gain of oxygen</p> <p><i>Example:</i>  <math>4\text{Fe} + 3\text{O}_2 \rightarrow 2\text{Fe}_2\text{O}_3</math>  <math>\text{CH}_4 + 2\text{O}_2 \rightarrow \text{CO}_2 + 2\text{H}_2\text{O}</math></p>	<p>Historical Definition:</p> <p>Loss of oxygen</p> <p><i>Example:</i>  <math>2\text{Fe}_2\text{O}_3 + 3\text{C} \rightarrow 4\text{Fe} + 3\text{CO}_2</math></p>
<p>Present Definition:</p> <p>Loss of electrons</p> <p><i>Example:</i>  <math>\text{Mg} + \text{S} \rightarrow \text{MgS}</math>            (Magnesium undergoes oxidation)</p>	<p>Present Definition:</p> <p>Gain of electrons</p> <p><i>Example:</i>  <math>\text{Mg} + \text{S} \rightarrow \text{MgS}</math>            (Sulphur undergoes reduction)</p>
<p>Mnemonic Device:</p> <p>OIL</p> <p>LEO</p>	<p>Mnemonic Device:</p> <p>RIG</p> <p>GER</p>
<p>When Balancing a Redox Reaction:</p> <p>One substance is <u>oxidized</u></p> <p>and it is also the <u>reducing</u> agent.</p> <p>Its oxidation number <u>increases</u> .</p>	<p>When Balancing a Redox Reaction:</p> <p>One substance is <u>reduced</u></p> <p>and it is also the <u>oxidizing</u> agent.</p> <p>Its oxidation number <u>decreases</u> .</p>

## Appendix 1.11: Oxidation Number Rules

The rules for assigning oxidation numbers are identified below.

**Rule 1:** The oxidation number of any free atom (or multiple of itself) is 0.

*Examples:*

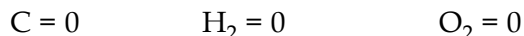

**Rule 2:** An ion's oxidation number is its charge when in ionic form.

*Examples:*

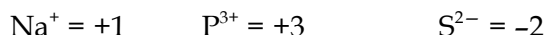

**Rule 3:** In a compound or complex ion, the sum of all the oxidation numbers of each part must equal the total charge of that compound or complex ion.

*Examples:*

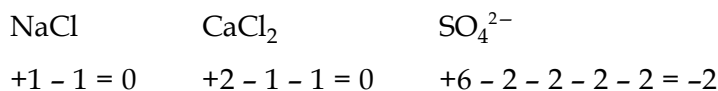

**Rule 4:** The oxidation number of hydrogen is +1, except in metal hydrides where H is the anion (e.g.,  $\text{CaH}_2$  or  $\text{LiH}$ ) and the oxidation number is -1.

**Rule 5:** The oxidation number of oxygen is -2, except in peroxides (e.g.,  $\text{H}_2\text{O}_2$ ,  $\text{Na}_2\text{O}_2$ ) where it is -1, and when in combination with fluorine ( $\text{O} = +2$ ).

**Rule 6:** The oxidation number of a Group IA (Group 1) element in a compound is +1.

**Rule 7:** The oxidation number of a Group IIA (Group 2) element in a compound is +2.

**Rule 8:** In most cases, the oxidation number of a Group VIIA (Group 17) element in a compound is -1.

**Rule 9:** Within a compound containing complex ions, each element's oxidation number can be determined using the charge on the complex ion.

*Example:*

- The compound  $\text{Ni}_2(\text{SO}_4)_3$  contains the ions  $\text{Ni}^{3+}$  and  $\text{SO}_4^{2-}$ .
- Since the oxidation number of O is -2 according to rule 5 (for a total of -8), S must be +6 to result in -2 charge on the sulphate ion.
- Therefore,

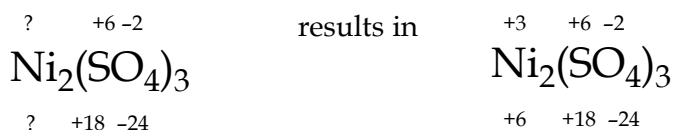

## Appendix 1.12A: Practical Applications of Redox Reactions (Research Report and Presentation)

---

To learn more about the practical applications of redox reactions taking place around you, your group (of no more than three students) will research one of the following topics, write a report on your findings, and give an oral presentation.

### Topics

1. rocket fuels
2. fireworks
3. household bleach (i.e., stain removal and chlorination)
4. photography
5. metal recovery from ores
6. steelmaking
7. aluminum recycling
8. fuel cells
9. batteries
10. tarnish removal
11. fruit clocks
12. forensic blood detection using luminol
13. chemiluminescence/bioluminescence
14. electrolytic cleaning
15. electrodeposition
16. photochemical etching
17. antioxidants/preservatives

### Resources

You will need access to resources such as the following:

- school, university, or public libraries
- Internet
- textbooks (see teacher)
- email communication (e.g., with an expert)
- magazines, journals, and newspapers
- interviews

## Appendix 1.12A: Practical Applications of Redox Reactions (Research Report and Presentation) *(continued)*

---

### **Project Requirements**

Your research, report, and presentation should include the following:

- Identify the redox application you have selected.
- Describe the redox reaction taking place, including information on the substances being oxidized and reduced, as well as the oxidizing agents and the reducing agents.
- Address the effects of the process on the environment, and the energy consumption involved in the process.

Submit your group's written project (of approximately two pages) to your teacher the day before your oral presentation. (Dates will be determined at the beginning of Topic 6: Electrochemistry, so that the written report can be copied for your classmates.)

The oral presentation should be approximately 10 minutes long and will be teacher-assessed. It will be followed by a brief question period (no longer than five minutes) in which the audience may ask clarifying questions.

### **Assessment**

Please refer to the attached checklist and rubric for a more detailed list of the project requirements and assessment criteria for both the written report and the oral presentation.



---

**Appendix 1.12B: Practical Applications of Redox Reactions (Sample Checklist and Assessment Rubric)**

---

**Checklist****Written Report**

Have you included the following?

- Title page
- Bibliography with at least five sources
- The selected redox application
- All relevant redox reactions taking place
- All substances being oxidized and reduced, and any oxidizing agents and reducing agents
- The effects of the process on the environment
- The energy consumption involved in the process
- An introduction and a conclusion that connect the topic to redox chemistry
- Visual aids that help make the topic more easily understood
- Five possible test questions about the topic
- An answer key to the test questions

**Oral Presentation**

Have you included the following?

- Equal participation by all group members
- The selected redox application
- All relevant redox reactions taking place
- All substances being oxidized and reduced, and any oxidizing agents and reducing agents
- The effects of the process on the environment
- The energy consumption involved in the process
- An introduction and a conclusion that connect the topic to redox chemistry
- A logical flow and clear transitions
- Visual aids that help make the topic more easily understood

**The information is**

- Clear, accurate, concise
- Presented fully
- Interesting and easily understood

---

**Appendix 1.12B: Practical Applications of Redox Reactions (Sample Checklist and Assessment Rubric) (continued)**

---

**Assessment Rubric**

<b>3</b>	<b>2</b>	<b>1</b>	<b>0</b>
All relevant redox reactions are correct and are included in both the written and oral reports.	All relevant redox reactions are correct and are included in one of the reports.	Some relevant redox reactions are included in the written and oral reports, with some errors.	No redox reactions are included in the reports.
All substances being oxidized and reduced and all oxidizing and reducing agents are correctly listed.	Some substances being oxidized and reduced and all oxidizing and reducing agents are correctly listed.	Substances being oxidized and reduced and oxidizing and reducing agents are incorrectly listed.	Substances being oxidized and reduced and oxidizing and reducing agents are not listed.

**TOPIC 2:**  
**ATOMIC STRUCTURE**

---



## Topic 2: Atomic Structure

- C12-2-01** Describe qualitatively the electromagnetic spectrum in terms of frequency, wavelength, and energy.
- C12-2-02** Recognize, through direct observation, that elements have unique line spectra.  
Include: flame tests or gas discharge tubes and spectrosopes or diffraction gratings
- C12-2-03** Describe applications and/or natural occurrences of line spectra.  
*Examples: astronomy, aurora borealis, fireworks, neon lights . . .*
- C12-2-04** Outline the historical development of the quantum mechanical model of the atom.
- C12-2-05** Write electron configurations for elements of the periodic table.  
Include: selected elements up to atomic number 36 (krypton)
- C12-2-06** Relate the electron configuration of an element to its valence electron(s) and its position on the periodic table.
- C12-2-07** Identify and account for periodic trends among the properties of elements, and relate the properties to electron configuration.  
Include: atomic radii, ionic radii, ionization energy, and electronegativity

**Suggested Time: 10 hours**

## Topic 2: Atomic Structure

### SPECIFIC LEARNING OUTCOMES

**C12-2-01:** Describe qualitatively the electromagnetic spectrum in terms of frequency, wavelength, and energy.

**C12-2-02:** Recognize, through direct observation, that elements have unique line spectra.

Include: flame tests or gas discharge tubes and spectroscopes or diffraction gratings

**C12-2-03:** Describe applications and/or natural occurrences of line spectra.

Examples: astronomy, aurora borealis, fireworks, neon lights . . .

(3 hours)

SLO: C12-2-01  
SLO: C12-2-02  
SLO: C12-2-03

### SUGGESTIONS FOR INSTRUCTION

#### Entry-Level Knowledge

In Grade 8 Science (8-2-07), students compared and contrasted various types of electromagnetic radiation with respect to energy, wavelength, frequency, and human perception. Students who have studied Grade 11 Physics (Topic 1: Waves) will be familiar with the terms *wavelength* and *frequency*.

#### General Learning Outcome Connections

- GLO A1:** Recognize both the power and limitations of science as a way of answering questions about the world and explaining natural phenomena.
- GLO A3:** Distinguish critically between science and technology in terms of their respective contexts, goals, methods, products, and values.
- GLO A5:** Recognize that science and technology interact with and advance one another.
- GLO B2:** Recognize that scientific and technological endeavours have been and continue to be influenced by human needs and the societal context of the time.
- GLO B3:** Identify the factors that affect health, and explain the relationships among personal habits, lifestyle choices, and human health, both individual and social.
- GLO B5:** Identify and demonstrate actions that promote a sustainable environment, society, and economy, both locally and globally.
- GLO C1:** Recognize safety symbols and practices related to scientific and technological activities and to their daily lives, and apply this knowledge in appropriate situations.
- GLO C2:** Demonstrate appropriate scientific inquiry skills when seeking answers to questions.
- GLO C4:** Demonstrate appropriate critical thinking and decision-making skills when choosing a course of action based on scientific and technological information.
- GLO C5:** Demonstrate curiosity, skepticism, creativity, open-mindedness, accuracy, precision, honesty, and persistence, and appreciate their importance as scientific and technological habits of mind.
- GLO C6:** Employ effective communication skills and use information technology to gather and share scientific and technological ideas and data.
- GLO D3:** Understand the properties and structures of matter, as well as various common manifestations and applications of the actions and interactions of matter.
- GLO D6:** Understand the composition of the universe, the interactions within it, and the implications of humankind's continued attempts to understand and explore it.

**SKILLS AND ATTITUDES OUTCOMES**

- C12-0-S1:** Demonstrate work habits that ensure personal safety and the safety of others, as well as consideration for the environment.  
Include: knowledge and use of relevant safety precautions, Workplace Hazardous Materials Information System (WHMIS), and emergency equipment
- C12-0-S4:** Select and use scientific equipment appropriately and safely.  
*Examples: volumetric glassware, balance, thermometer . . .*
- C12-0-R1:** Synthesize information obtained from a variety of sources.  
Include: print and electronic sources, specialists, and other resource people
- C12-0-T1:** Describe examples of the relationship between chemical principles and applications of chemistry.
- 

**Assessing Prior Knowledge**

Students' prior knowledge can be reviewed and/or assessed by using any of the KWL forms (e.g., Concept Map, Knowledge Chart, Think-Pair-Share – see *SYSTH*, Chapter 9).

**TEACHER NOTES****The Electromagnetic Spectrum (C12-2-01)**

One purpose of studying atomic structure is to understand the electron's role in the atom. Scientists at the turn of the twentieth century had just discovered this subatomic particle, but they did not fully understand the magnitudes of types of energy associated with an electron. By furthering their studies in this area, scientists hoped they could better explain the behaviour of substances in chemical reactions.

In Topic 2: Atomic Structure, the electromagnetic spectrum will be linked to atomic structure. The electromagnetic spectrum consists of electromagnetic radiation, which is the release and transmission of energy in the form of electromagnetic waves. These waves consist of an electric field and a magnetic field that are perpendicular to each other. The different components (gamma rays, X-rays, microwaves, visible light, and others) of the electromagnetic spectrum vary due to differences in wavelength and frequency, but they all travel at the same speed,  $3 \times 10^8$  m/s. Energy is transferred by means of waves – more specifically with respect to atomic structure, electromagnetic waves.

Students should understand the relationship between wavelength ( $\lambda$ ) and frequency ( $f$ ) as an inverse one ( $\lambda = 1/f$ ). However, they are not required to treat the relationship mathematically. It is more important for students to understand conceptually that over a given span of distance, if the wavelength of a disturbance is shortened (made smaller), then a greater number of waves would be able to fit into that distance (increase in frequency).

**Topic 2:  
Atomic  
Structure**

**SPECIFIC LEARNING OUTCOMES**

**C12-2-01:** Describe qualitatively the electromagnetic spectrum in terms of frequency, wavelength, and energy.

**C12-2-02:** Recognize, through direct observation, that elements have unique line spectra.

Include: flame tests or gas discharge tubes and spectroscopes or diffraction gratings

**C12-2-03:** Describe applications and/or natural occurrences of line spectra.

Examples: astronomy, aurora borealis, fireworks, neon lights . . .

(continued)

A coiled spring toy, for example, can be used to show the relationship between frequency and wavelength (see the following diagrams). Holding one end of the toy, move your hand back and forth slowly. This illustrates a large wavelength (the distance from one crest to the next successive crest) and a low frequency. Increasing the frequency of the back-and-forth movement of your hand will result in a smaller wavelength. In both cases, the speed of the wave is the same.

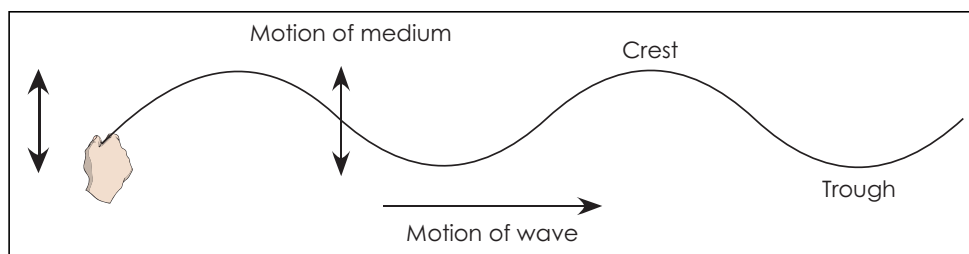

The following diagram shows clearly the relationship between wavelength ( $\lambda$ ) and the number of cycles in a given space (*frequency* of the wave).

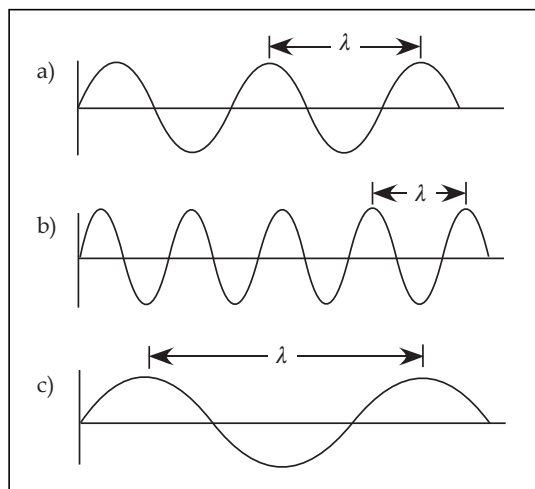



**SKILLS AND ATTITUDES OUTCOMES**

**C12-0-S1:** Demonstrate work habits that ensure personal safety and the safety of others, as well as consideration for the environment.

Include: knowledge and use of relevant safety precautions, Workplace Hazardous Materials Information System (WHMIS), and emergency equipment

**C12-0-S4:** Select and use scientific equipment appropriately and safely.

Examples: volumetric glassware, balance, thermometer . . .

**C12-0-R1:** Synthesize information obtained from a variety of sources.

Include: print and electronic sources, specialists, and other resource people

**C12-0-T1:** Describe examples of the relationship between chemical principles and applications of chemistry.

---

The *energy* of the various parts of the electromagnetic (em) spectrum is directly related to the *frequency* of the wave. If a wave has a high frequency, then it will contain a higher amount of energy. For example, gamma rays are high-energy waves due to their very high frequency ( $10^{20}$  Hz). Radio waves are low-energy waves, as their frequency is approximately  $10^6$  Hz.

Visible light, with its colours ranging from red to violet, is the portion of the electromagnetic spectrum that is detected by the human eye. A common mnemonic used to remember the colour spectrum is ROYGBIV. Ask students whether they can recall this mnemonic from previous study (ROYGBIV: red, orange, yellow, green, blue, indigo, violet). Within this range of colours, red light has the largest wavelength (small frequency). At the other end of the spectrum, violet light has the smallest wavelength (large frequency).

When an iron nail is heated in a Bunsen burner flame, it will glow bright red. The human eye is sensitive to the frequency and wavelength of the electromagnetic radiation within this range, and it is seen as red. If you place your hand near the iron nail, your hand will detect the warmth of the nail, which is represented by the infrared region of the electromagnetic spectrum.

**Demonstrations**

Several quick demonstrations can be performed to show the visible spectrum.

1. Hold up a glass prism to an overhead light and have students observe the white light that passes through the prism break apart into a range of colours, known as a spectrum. This can be projected on the classroom wall, ceiling, or overhead screen.
2. Have students look at light being diffracted by a CD. This also shows a spectrum of colours.

**Topic 2:  
Atomic  
Structure**

---

**SPECIFIC LEARNING OUTCOMES**

**C12-2-01:** Describe qualitatively the electromagnetic spectrum in terms of frequency, wavelength, and energy.

**C12-2-02:** Recognize, through direct observation, that elements have unique line spectra.

Include: flame tests or gas discharge tubes and spectroscopes or diffraction gratings

**C12-2-03:** Describe applications and/or natural occurrences of line spectra.

Examples: astronomy, aurora borealis, fireworks, neon lights . . .

(continued)

---

**TEACHER NOTES****Line Spectra (C12-2-02)**

Emission spectra can exist as continuous spectra or line spectra.

- A *continuous spectrum* shows all the wavelengths of light in an uninterrupted pattern, as demonstrated with the glass prism on the overhead. A common occurrence with which students should be familiar is the rainbow, an uninterrupted sequence of colours ranging from red to violet.
- A *line spectrum* consists of distinct bright lines appearing on a dark background that occur in different parts of the visible spectrum. This distinguishing feature of gaseous atoms provides scientists with a unique “fingerprint” for each element. Each element has its own unique line spectrum, as each element contains differing amounts of electrons or different energy levels. These bright lines indicate that only certain energies are possible within the atom. The brightness of spectral lines depends on how many photons of the same wavelength are emitted.

**Demonstrations**

Perform the following demonstrations:

1. In a darkened room, hold a Tesla coil near a graphite (carbon) rod secured by a clamp to a ringstand. The spark that results shows a lightning bolt, which is composed of the nitrogen spectrum. This can be related to natural occurrences of light spectra, such as a rainbow or the northern lights (*aurora borealis*). (The physics teacher in your school may have a Tesla coil.)
2. Apply an electric current through a dill pickle and cause it to glow. The excited sodium atoms emit a yellow light (589 nanometre) when they drop back down to the ground state. This demonstration can be found in the *Journal of Chemical Education* (see Learning Resources Links). Instructions for this demonstration are also found online.

*Sample Website:*

Lori’s Chemistry Page. *Complete with the Glowing Pickle.*

<<http://myglowingpickle.com/>> (30 Jan. 2012).

---

**SKILLS AND ATTITUDES OUTCOMES**

- C12-0-S1:** Demonstrate work habits that ensure personal safety and the safety of others, as well as consideration for the environment.  
Include: knowledge and use of relevant safety precautions, Workplace Hazardous Materials Information System (WHMIS), and emergency equipment
- C12-0-S4:** Select and use scientific equipment appropriately and safely.  
*Examples: volumetric glassware, balance, thermometer . . .*
- C12-0-R1:** Synthesize information obtained from a variety of sources.  
Include: print and electronic sources, specialists, and other resource people
- C12-0-T1:** Describe examples of the relationship between chemical principles and applications of chemistry.

**Laboratory Activities**

The purpose of the suggested lab activities is to have students observe continuous spectra and line spectra. An analogy can be made to differentiate between these two types of spectra. A wheelchair ramp is similar to a continuous spectrum, whereas a staircase is similar to a line spectrum. Students should recognize that each element has its own unique line spectrum. For these lab activities, students can use commercially made spectroscopes or they can make their own.

1. Have students use prisms or spectroscopes to observe white light from an incandescent light bulb. Students will see a continuous spectrum of colours ranging from red to violet.

**Caution:**

Do not permit students to view sunlight directly.

Have students view a fluorescent light bulb through the spectroscopes. They will observe line spectra superimposed on the visible light spectra (continuous spectra). This happens because some of the mercury atoms emit ultraviolet (UV) light, which is not visible to the human eye. This UV light is absorbed by the phosphor coating of the fluorescent tube. When these phosphor electrons return to the ground state, they give off a white light that has more blue and less red than sunlight (see Wilbraham, et al., *Prentice Hall Chemistry* 137). Different types of fluorescent tubes give off their own unique spectrum. An Internet search can direct you to the spectra of these tubes.

Students can make their own mini spectroscopes. Instructions can be found online.

*Sample Website:*

Schwabacher, Alan. "Mini Spectroscopes." *The Science of Stuff*. Rev. 8 Jan. 2002. University of Wisconsin, Department of Chemistry.  
<<https://pantherfile.uwm.edu/awschwab/www/specweb.htm>>  
(13 Jan. 2012).

2. Have students observe examples of emission line spectra using either gas discharge tubes (if available) or colour flames. See Appendix 2.1: Spectral Lines as a reference for the wavelength and colour of specific elements.

**Topic 2:  
Atomic  
Structure**

---

**SPECIFIC LEARNING OUTCOMES**

**C12-2-01:** Describe qualitatively the electromagnetic spectrum in terms of frequency, wavelength, and energy.

**C12-2-02:** Recognize, through direct observation, that elements have unique line spectra.

Include: flame tests or gas discharge tubes and spectroscopes or diffraction gratings

**C12-2-03:** Describe applications and/or natural occurrences of line spectra.

*Examples: astronomy, aurora borealis, fireworks, neon lights . . .*

*(continued)*

---

**■ Gas Discharge Tubes**

As students view the gas discharge tubes, have them draw the actual line spectra, indicate the colours, and note the approximate location of the spectral lines. See Appendix 2.2: Gas Discharge Tubes (BLM). Students should then compare their observed line spectra to the known line spectra in order to identify the element present in the gas mixture. For example, students should observe four spectral lines for hydrogen: violet, blue-violet, blue-green, and red. Point out to students that these visible spectral lines represent electron transitions from energy levels 3, 4, 5, and 6 to energy level 2. (Energy levels are addressed in greater detail in subsequent learning outcomes.)

**Caution:**

Teachers should handle the power supplies and the gas spectrum tubes. Students must exercise caution when viewing the spectrum tubes. These tubes get hot very quickly and can cause burns.

**■ Metallic Salts**

Students can view wooden splints that have been soaked for a few days in different solutions of metallic salts, such as 1/mol saturated solutions of barium, calcium, copper(II), potassium, and sodium. Students should be able to observe the specific colour of the metal for a brief moment.

**Demonstration**

Perform the following demonstration.

**■ Flaming Salts**

For this demonstration, ignite a series of salt solutions mixed in methanol and have students observe the colours given off. Refer to Appendix 2.3: Flaming Salts (Demonstration).

**SKILLS AND ATTITUDES OUTCOMES**

- C12-0-S1:** Demonstrate work habits that ensure personal safety and the safety of others, as well as consideration for the environment.  
Include: knowledge and use of relevant safety precautions, Workplace Hazardous Materials Information System (WHMIS), and emergency equipment
- C12-0-S4:** Select and use scientific equipment appropriately and safely.  
*Examples: volumetric glassware, balance, thermometer . . .*
- C12-0-R1:** Synthesize information obtained from a variety of sources.  
Include: print and electronic sources, specialists, and other resource people
- C12-0-T1:** Describe examples of the relationship between chemical principles and applications of chemistry.
- 

**TEACHER NOTES****Applications and Natural Occurrences of Line Spectra (C12-2-03)**

As students have now seen and drawn line spectra, they should be ready to discuss the applications and/or natural occurrences of line spectra. Students will be familiar with fireworks and neon lights. However, most students may not know, for example, that neon gas generates an orange-red light.

Spectral lines are produced by an atom in the excited state. First, the atom must absorb energy. Electrons are then raised to a higher energy level by absorbing energy. When the electron falls back down to a lower energy level, it simultaneously gives off a colour of light, which could also be referred to as a single wavelength, or a single frequency, or a single packet of energy being emitted. This corresponds to the distance that the electron travelled. Since many electron transitions are possible between energy levels, many spectral lines are produced by an atom in the excited state.

For the hydrogen atom, when the electron falls from energy level 3 down to energy level 2, a red colour is emitted. This should make sense, as the electron is falling the shortest distance, which corresponds to the lowest frequency of visible light, which is red. If an electron falls from energy level 4 to energy level 2, a green colour is emitted. If it falls from energy level 5 to energy level 2, an indigo colour is emitted. And, if it falls from energy level 6 to energy level 2, a violet colour is emitted.

Many chemistry texts give examples of line spectra for at least some elements. Viewing such examples will help students appreciate that each element has its own unique line spectrum. The line spectra could then be used to analyze a light source for its constituent elements. A typical application occurs in astronomy when an astronomer passes the light from a distant light source through a spectroscope to determine what elements were contained in the light. Light sources could be stars, nebula, supernova explosions in external galaxies, and so on. It is also possible for astronomers to detect forms of radiation other than visible light. For example, X-rays and gamma rays are emitted from very dense neutron stars, or emanate from black holes. It is also historically important that the element helium was first identified in the spectrum of the Sun before it was detected in Earth's atmosphere (and hence, named from the Greek *helios*, a reference to the Greek sun god). The historical link between physics and chemistry could be explored.

**Topic 2:  
Atomic  
Structure**

---

**SPECIFIC LEARNING OUTCOMES**

**C12-2-01:** Describe qualitatively the electromagnetic spectrum in terms of frequency, wavelength, and energy.

**C12-2-02:** Recognize, through direct observation, that elements have unique line spectra.

Include: flame tests or gas discharge tubes and spectroscopes or diffraction gratings

**C12-2-03:** Describe applications and/or natural occurrences of line spectra.

*Examples: astronomy, aurora borealis, fireworks, neon lights . . .*

*(continued)*

---

Students may have used an open flame to observe line spectra. A familiar application of the spectra produced by elements is the manufacture of fireworks. The following is a selection of the colours of elements as they are ignited:

Barium: yellow-green

Strontium: bright red

Calcium: orange-red

Sodium: bright yellow

Potassium: light purple

Lithium: purple-red

Copper: green

The Internet contains a wealth of information on the chemistry and manufacture of fireworks (for sample websites, see Learning Resources Links).

**Research**

Students could research and write a report on an application or a natural occurrence of line spectra (e.g., astronomy, aurora borealis, fireworks, neon lights).

1. If sufficient time is available, students could research both fireworks and the use of line spectra for analysis. If gas discharge tubes were demonstrated in addressing the previous learning outcome, students will know that neon gas produces only the orange-red light, and other colours of discharge tubes are produced by other gases (e.g., argon produces green, helium produces pink-orange, krypton produces lavender, xenon produces blue).
2. Students could research “how astrophysicists can determine what elements make up Earth’s Sun and other stars. In general, because a star is made up of hot, glowing gases, its emitted light can be gathered by a telescope and analyzed. From the atomic emission and absorption spectra of the light, the elements present in the star can be determined” (Dingrando, et al., *Glencoe Chemistry: Matter and Change, Teacher Wraparound Edition* 124).

**SKILLS AND ATTITUDES OUTCOMES**

**C12-0-S1:** Demonstrate work habits that ensure personal safety and the safety of others, as well as consideration for the environment.

Include: knowledge and use of relevant safety precautions, Workplace Hazardous Materials Information System (WHMIS), and emergency equipment

**C12-0-S4:** Select and use scientific equipment appropriately and safely.

Examples: volumetric glassware, balance, thermometer . . .

**C12-0-R1:** Synthesize information obtained from a variety of sources.

Include: print and electronic sources, specialists, and other resource people

**C12-0-T1:** Describe examples of the relationship between chemical principles and applications of chemistry.

---

**SUGGESTIONS FOR ASSESSMENT**

---

**Paper-and-Pencil Tasks**

1. Students should be able to do the following:
  - Draw a series of diagrams showing the relationship between the frequency and wavelength of an electromagnetic wave.
  - Relate the frequency of electromagnetic radiation with the amount of energy these waves contain.
  - Explain what happens to energy when frequency is doubled.
  - Explain what happens to energy when frequency is halved.
2. Following the lab activities suggested for learning outcome C12-2-02, have students compare the light spectrum observed in fluorescent light with that observed in incandescent light (see Appendix 2.4: Observing Continuous Spectra and Line Spectra).

**Laboratory Skills**

Students should be able to handle and use diffraction gratings, prisms, and spectrosopes safely.

**Research Report**

Students can prepare and present their research findings on one of the applications and/or natural occurrences of line spectra. Written reports, oral presentations, posters, models, multimedia presentations, or displays can be used. A rubric for Assessment of Research Project is provided in Appendix 11.

**Topic 2:  
Atomic  
Structure**

---

**SPECIFIC LEARNING OUTCOMES**

**C12-2-01:** Describe qualitatively the electromagnetic spectrum in terms of frequency, wavelength, and energy.

**C12-2-02:** Recognize, through direct observation, that elements have unique line spectra.

Include: flame tests or gas discharge tubes and spectroscopes or diffraction gratings

**C12-2-03:** Describe applications and/or natural occurrences of line spectra.

*Examples: astronomy, aurora borealis, fireworks, neon lights . . .*

*(continued)*

---

**LEARNING RESOURCES LINKS**

---



*Chemistry* (Chang 260, 262, 268)

*Chemistry* (Zumdahl and Zumdahl 292, 304)

*Chemistry: The Molecular Nature of Matter and Change* (Silberberg 258, 264, 269)

*Glencoe Chemistry: Concepts and Applications* (Phillips, Strozak, and Wistrom 70, 73, 76)

*Glencoe Chemistry: Matter and Change* (Dingrando, et al. 118, 120, 128, 131, 138)

*Glencoe Chemistry: Matter and Change, Teacher Wraparound Edition* (Dingrando, et al. 124)

*Nelson Chemistry 11, Ontario Edition* (Jenkins, et al. 39, 635, 637)

*Nelson Chemistry 12, Ontario Edition* (van Kessel, et al. 39)

*Nelson Chemistry 12: College Preparation, Ontario Edition* (Davies, et al. 16)

*McGraw-Hill Ryerson Inquiry into Chemistry* (Chastko, et al. 169)

*Prentice Hall Chemistry* (Wilbraham, et al. 126, 137, 138, 141, 142)

**Line Spectra**

*Chemistry* (Chang 268)

*Chemistry: The Molecular Nature of Matter and Change* (Silberberg 264)

*Glencoe Chemistry: Concepts and Applications* (Phillips, Strozak, and Wistrom 235)

*Nelson Chemistry 11, Ontario Edition* (Jenkins, et al. 637)

*Nelson Chemistry 12: College Preparation, Ontario Edition* (Davies, et al. 17, 489)



**SKILLS AND ATTITUDES OUTCOMES**

- C12-0-S1:** Demonstrate work habits that ensure personal safety and the safety of others, as well as consideration for the environment.  
Include: knowledge and use of relevant safety precautions, Workplace Hazardous Materials Information System (WHMIS), and emergency equipment
- C12-0-S4:** Select and use scientific equipment appropriately and safely.  
*Examples: volumetric glassware, balance, thermometer . . .*
- C12-0-R1:** Synthesize information obtained from a variety of sources.  
Include: print and electronic sources, specialists, and other resource people
- C12-0-T1:** Describe examples of the relationship between chemical principles and applications of chemistry.

**Investigations**

*Glencoe Chemistry: Concepts and Applications* (Phillips, Strozak, and Wistrom)  
MiniLab 2.2: Line Emission Spectra of Elements, 77

*Glencoe Chemistry: Matter and Change* (Dingrando, et al.)  
ChemLab 5: Line Spectra, 142

*Nelson Chemistry 11*, Ontario Edition (Jenkins, et al.)  
Investigation 1.4.1: Atomic Spectra, 40  
Activity 1.4.1: Creating a Flame Test Key, 42

*Nelson Chemistry 12*, Ontario Edition (van Kessel et al.)  
Activity 3.4.1: Line Spectra, 212

*Nelson Chemistry 12: College Preparation*, Ontario Edition (Davies, et al.)  
Identifying Gases Using Line Spectra, 19  
Flame Tests, 23

*Prentice Hall Chemistry* (Wilbraham, et al.)  
Small-Scale LAB: Atomic Emission Spectra, 137  
Quick LAB: Flame Tests, 142

**Demonstration**

Gilbert, George L. "Tested Demonstrations: Sodium D Line Emission from Pickle." *Journal of Chemical Education* 70.3 (Mar. 1993): 250–251.

**Websites**

Edward M. Gouge. "A Flame Test Demonstration Device." *Journal of Chemical Education* 65.6 (June 1988): 544. Available online at  
<<http://pubs.acs.org/doi/abs/10.1021/ed065p544>> (13 Jan. 2012).

Glencoe Online. "An Internet WebQuest: The History of Fireworks." *WebQuest Science*. <[www.glencoe.com/sec/science/webquest/content/fireworks.shtml](http://www.glencoe.com/sec/science/webquest/content/fireworks.shtml)> (1 Feb. 2012).

This website presents the history and components of fireworks.

HowStuffWorksVideos. *Fireworks Videos*. 1998–2012.  
<<http://videos.howstuffworks.com/science/fireworks-videos-playlist.htm#video-8329>> (13 Jan. 2012).

This website offers a series of videos showing how fireworks work.

**Topic 2:  
Atomic  
Structure**

---

**SPECIFIC LEARNING OUTCOMES**

**C12-2-01:** Describe qualitatively the electromagnetic spectrum in terms of frequency, wavelength, and energy.

**C12-2-02:** Recognize, through direct observation, that elements have unique line spectra.

Include: flame tests or gas discharge tubes and spectroscopes or diffraction gratings

**C12-2-03:** Describe applications and/or natural occurrences of line spectra.

*Examples: astronomy, aurora borealis, fireworks, neon lights . . .*

*(continued)*

---

Lori's Chemistry Page. *Complete with the Glowing Pickle.*

<<http://myglowingpickle.com/>> (30 Jan. 2012).

Pyro Universe. Home Page. <[www.pyrouniverse.com](http://www.pyrouniverse.com)> (31 Jan. 2012).

This website presents a history of fireworks and a glossary of pyrotechnic terms.

Schwabacher, Alan. "Mini Spectroscopes." *The Science of Stuff*. Rev. 8 Jan. 2002. University of Wisconsin. Department of Chemistry.

<<https://pantherfile.uwm.edu/awschwab/www/specweb.htm>> (13 Jan. 2012).

University of Colorado at Boulder. "Spectral Line." *Physics 2000: Science Trek*.

<[www.colorado.edu/physics/2000/quantumzone/index.html](http://www.colorado.edu/physics/2000/quantumzone/index.html)> (1 Feb. 2012).

This website shows a continuous spectrum for light and line spectra for various elements.

**Appendices**

Appendix 2.1: Spectral Lines

Appendix 2.2: Gas Discharge Tubes (BLM)

Appendix 2.3: Flaming Salts (Demonstration)

Appendix 2.4: Observing Continuous Spectra and Line Spectra

**Selecting Learning Resources**

For additional information on selecting learning resources for Grade 11 and Grade 12 Chemistry, see the Manitoba Education website at <[www.edu.gov.mb.ca/k12/learnres/bibliographies.html](http://www.edu.gov.mb.ca/k12/learnres/bibliographies.html)>.

**SKILLS AND ATTITUDES OUTCOMES**

**C12-0-S1:** Demonstrate work habits that ensure personal safety and the safety of others, as well as consideration for the environment.

Include: knowledge and use of relevant safety precautions, Workplace Hazardous Materials Information System (WHMIS), and emergency equipment

**C12-0-S4:** Select and use scientific equipment appropriately and safely.

*Examples: volumetric glassware, balance, thermometer . . .*

**C12-0-R1:** Synthesize information obtained from a variety of sources.

Include: print and electronic sources, specialists, and other resource people

**C12-0-T1:** Describe examples of the relationship between chemical principles and applications of chemistry.

---

**NOTES**

**Topic 2:  
Atomic  
Structure**
**SPECIFIC LEARNING OUTCOME**

**C12-2-04:** Outline the historical development of the quantum mechanical model of the atom.

(1.5 hours)

SLO: C12-2-04

**SUGGESTIONS FOR INSTRUCTION**
**Entry-Level Knowledge**

In Grade 9 Science (S2-2-02), students investigated the historical progression of ideas with respect to the atomic model. Students were also required to draw simplified Bohr models up to atomic number 18 (argon) (S1-2-05).

**TEACHER NOTES**
**Historical Development of Quantum Mechanical Model**

The historical development of the quantum mechanical model of the atom is a complex, theoretical topic. Most chemistry texts provide information on this topic, but the extent and complexity of the treatment varies. The presentation to students should be as logical and as simple as possible. The following suggested sequence of events omits Einstein's contribution, as the photoelectric effect is not relevant to the historical progression.

In 1913, Danish physicist Niels Bohr (1885–1962) proposed a *model for the hydrogen atom*, which states that when radiation is absorbed by an atom, an electron jumps from the ground state to a higher unstable energy level (excited state). This electron eventually loses energy and changes to a lower energy level by emitting energy in the form of light. Using arguments based on electrostatic interactions and Newtonian physics, Bohr showed that the energies of the electron in the hydrogen atom could be calculated by a simple relationship involving the Rydberg constant and a whole number that later became known as the *principal quantum number* ( $n$ ).

Johannes Robert Rydberg (1854–1919), a Swedish physicist who did his most important work on spectroscopy, found a simple relationship relating the various lines in the spectra of the elements. His expression included a constant that later became known as the *Rydberg constant*. The values that Bohr calculated compared

**General Learning Outcome Connections**

- GLO A1:** Recognize both the power and limitations of science as a way of answering questions about the world and explaining natural phenomena.
- GLO A2:** Recognize that scientific knowledge is based on evidence, models, and explanations, and evolves as new evidence appears and new conceptualizations develop.
- GLO A4:** Identify and appreciate contributions made by women and men from many societies and cultural backgrounds that have increased our understanding of the world and brought about technological innovations.
- GLO D3:** Understand the properties and structures of matter, as well as various common manifestations and applications of the actions and interactions of matter.

## SKILLS AND ATTITUDES OUTCOMES

**C12-0-N1:** Explain the roles of theory, evidence, and models in the development of scientific knowledge.

**C12-0-N2:** Describe, from a historical perspective, how the observations and experimental work of many individuals led to modern understandings of matter.

**C12-0-N3:** Describe how scientific knowledge changes as new evidence emerges and/or new ideas and interpretations are advanced.

favourably with the experimental values that had been observed earlier. This provided strong evidence for the veracity of his model.

The following illustration shows the increase in potential energy as an electron moves from the ground state to different excited states. The diagram illustrates the energy levels.

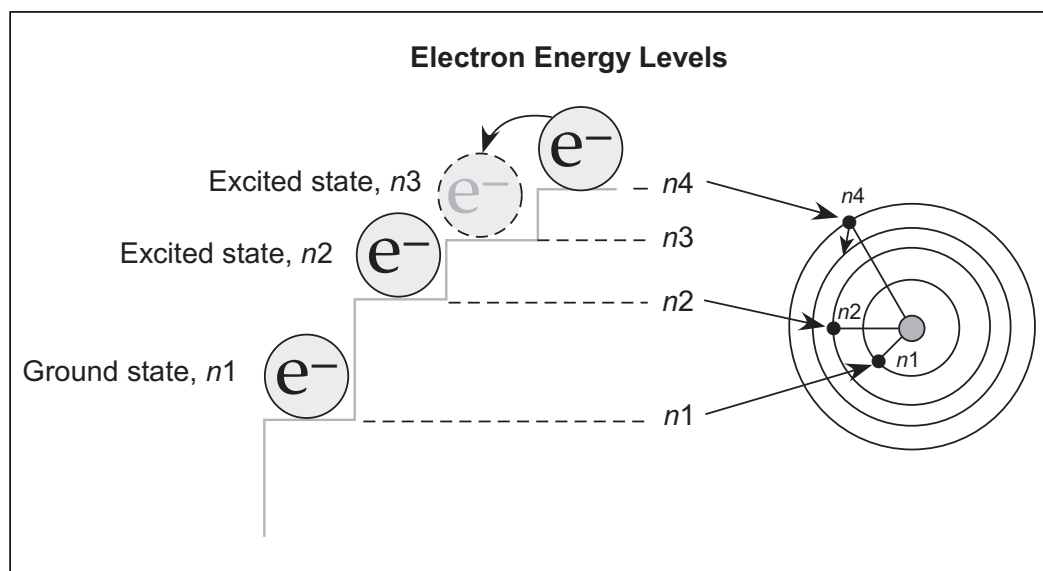

Physicists were both mystified and intrigued by Bohr's model of the atom. They questioned why the energies of electrons allowed only certain energies (later called *quantization*). Apparently, even Bohr was not able to provide a logical explanation.

In 1924, French physicist Louis de Broglie (1892–1987) proposed a solution. He reasoned that if light waves can behave like a stream of particles, then perhaps particles such as electrons could similarly behave like waves. In his discussions, he related the circumference of an atomic orbit to the wavelength of an electron travelling around the nucleus. Shortly after de Broglie introduced this relationship, American physicists Clinton Joseph Davisson (1881–1958) and Lester Halbert Germer (1896–1972) and English physicist George Paget Thomson (1892–1975) actually demonstrated that electrons do possess wavelike properties.

**Topic 2:  
Atomic  
Structure****SPECIFIC LEARNING OUTCOME****C12-2-04:** Outline the historical development of the quantum mechanical model of the atom.*(continued)*

New questions then arose over the position of the electron. If an electron can act as a wave, how can its precise location be defined within the atom? This led German physicist Werner Heisenberg (1901–1976) to develop the *Heisenberg uncertainty principle*, which states that it is impossible to know with certainty both the momentum (or velocity) and the position of a particle at the same time.

Bohr made a significant contribution to our understanding of atoms, but his theory did not provide a complete description of electronic behaviour within the atom. In 1926, Austrian physicist Erwin Schrödinger (1887–1961), using complex differential calculus, developed an equation that describes the energies and behaviour of submicroscopic particles. The importance of this equation is analogous to the contributions of Isaac Newton in terms of our understanding of the position and motion of particles. While Newton’s discussion focused on large, macroscopic bodies, Schrödinger provided a novel, probabilistic view of the microscopic world. For instance, Schrödinger’s equation represents the statistical probability of finding an electron in a particular volume of space in the atom. The work of Schrödinger contributed to beginning a new era in physics and chemistry that culminated in the articulation of a new mechanics – namely, *quantum mechanics*.

**Animation: Electron Orbits**

Have students view an animation that shows the absorption and emission of photons by a hydrogen atom. Students will observe how an electron absorbs energy and travels to a higher orbital around the nucleus. Then the electron in this excited state emits a photon and drops back down to a lower energy level. Students should note that the electron is not very stable in the excited state and it prefers to drop back down to a lower energy orbital.

*Sample Websites:*

University of Colorado at Boulder. “Atomic Spectra.” *Physics 2000: Science Trek*.  
<[www.colorado.edu/physics/2000/quantumzone/lines2.html](http://www.colorado.edu/physics/2000/quantumzone/lines2.html)> (3 Aug. 2012).

This animation allows students to click on an orbital to move a hydrogen electron either up or down. A corresponding wave of light is either absorbed or emitted.

Visionlearning, Inc. “Bohr’s Atom: Quantum Behavior in Hydrogen.” *Library*.  
<[www.visionlearning.com/library/flash\\_viewer.php?oid=1347&mid=51](http://www.visionlearning.com/library/flash_viewer.php?oid=1347&mid=51)>  
(3 Aug. 2012).

This animation allows students to excite a hydrogen atom up through four orbits and then allow it to fall back to any lower orbit down to its ground state. A brief pulse of light will be emitted at each fall, with the numerical value of that wavelength displayed.

**SKILLS AND ATTITUDES OUTCOMES**

**C12-0-N1:** Explain the roles of theory, evidence, and models in the development of scientific knowledge.

**C12-0-N2:** Describe, from a historical perspective, how the observations and experimental work of many individuals led to modern understandings of matter.

**C12-0-N3:** Describe how scientific knowledge changes as new evidence emerges and/or new ideas and interpretations are advanced.

---

**Learning Activity/Demonstration: Bohr's Atomic Theory and Emission Spectrum**

Have students model emission spectra using the following items:

- small coloured balls (or coloured markers) – representing different photons with energies corresponding to their colours
- floor space – representing the ground state
- a chair, a tall stool, and a table counter – representing the higher energy levels

The gap between the floor and the chair needs to be larger than the gap between the chair and stool. The counter must be higher than the stool.

The teacher (or a student) plays the role of an electron that jumps between different energy levels.

- The teacher gives red, yellow, blue, violet, and black balls to students, while keeping a red, a blue, and a violet ball. The first student throws a violet ball at the teacher. While catching the ball, the teacher jumps from the floor (first energy level) onto the stool (third energy level). This represents the absorption of a violet photon. The teacher immediately takes a violet ball (e.g., out of his or her pocket), throws it in a different direction than the incoming ball's direction, and jumps down to the floor. This represents the release of a photon and corresponds to the violet line in the hydrogen emission spectrum.
- If a student throws a blue ball, the teacher jumps onto the chair (second energy level). The teacher releases a blue ball from his or her pocket, and throws it in a different direction than the incoming ball's direction, and jumps down to the floor. This represents the release of a photon and corresponds to the blue line in the hydrogen emission spectrum.
- The exercise continues with the red balls, which represent the energy between the second level (the chair) and the third level (the stool) and correspond to the red line in the hydrogen emission spectrum.
- If the student throws a yellow ball, the teacher ignores it, as yellow does not correspond to one of the energy-level transitions in hydrogen.
- Finally, the teacher catches a black ball (representing ultraviolet), jumps onto the counter, and runs free of the nucleus. This represents *ionization*.

**Topic 2:  
Atomic  
Structure****SPECIFIC LEARNING OUTCOME****C12-2-04:** Outline the historical development of the quantum mechanical model of the atom.*(continued)*

---

This learning activity demonstrates a number of key points of Bohr's atomic theory and emission spectra. The coloured balls represent the different energy levels and the different energies correspond to jumps of different sizes. The emitted photon is typically ejected in a different direction than the incident photon. Electron jumps correspond to a small set of specific energy values.

**SUGGESTIONS FOR ASSESSMENT**

---

**Research**

1. Have students develop a timeline for the scientific research that resulted in modifications to the understanding of the structure of an atom.
2. Have students research the scientists whose work led to the establishment of the quantum mechanical model of the atom. Students' research findings could be presented in the form of
  - written reports
  - oral presentations
  - bulletin-board displays
  - multimedia presentations

For assessment rubrics, refer to Appendix 11.

**Note:**

The historical development of the atom is an interesting account of experimental interpretations and theoretical explanations. It is not necessary for students to memorize this development, but they need to appreciate its complexity.

**Paper-and-Pencil Task**

Have students use a diagram to explain the structure of the atom in terms of the absorption of energy and the subsequent movement of electrons from one energy level to another.



**SKILLS AND ATTITUDES OUTCOMES**

- C12-0-N1:** Explain the roles of theory, evidence, and models in the development of scientific knowledge.
- C12-0-N2:** Describe, from a historical perspective, how the observations and experimental work of many individuals led to modern understandings of matter.
- C12-0-N3:** Describe how scientific knowledge changes as new evidence emerges and/or new ideas and interpretations are advanced.

**LEARNING RESOURCES LINKS**

*Chemistry* (Chang 264, 266, 279)

*Chemistry* (Zumdahl and Zumdahl 301, 306)

*Chemistry: The Molecular Nature of Matter and Change* (Silberberg 275)

*Glencoe Chemistry: Matter and Change* (Dingrando, et al. 127, 131)

*Great Physicists: The Life and Times of Leading Physicists from Galileo to Hawking* (Cropper)

*Nelson Chemistry 11, Ontario Edition* (Jenkins, et al. 37, 45)

*Nelson Chemistry 12, College Preparation, Ontario Edition* (Davies, et al. 21)

*Nelson Chemistry 12, Ontario Edition* (van Kessel, et al. 37, 45)

*Prentice Hall Chemistry* (Wilbraham, et al. 127, 130, 144)

*World of Physics* (McGrath)

**Demonstration**

Palmquist, Bruce C. "Interactive Spectra Demonstration."  
*The Physics Teacher* 40.3 (Mar. 2002): 140.

**Websites**

University of Colorado at Boulder. "Atomic Spectra." *Physics 2000: Science Trek*. <[www.colorado.edu/physics/2000/quantumzone/lines2.html](http://www.colorado.edu/physics/2000/quantumzone/lines2.html)> (3 Aug. 2012).

Visionlearning, Inc. "Bohr's Atom: Quantum Behavior in Hydrogen." *Library*. <[www.visionlearning.com/library/flash\\_viewer.php?oid=1347&mid=51](http://www.visionlearning.com/library/flash_viewer.php?oid=1347&mid=51)> (3 Aug. 2012).

**Selecting Learning Resources**

For additional information on selecting learning resources for Grade 11 and Grade 12 Chemistry, see the Manitoba Education website at <[www.edu.gov.mb.ca/k12/learnres/bibliographies.html](http://www.edu.gov.mb.ca/k12/learnres/bibliographies.html)>.

## Topic 2: Atomic Structure

### SPECIFIC LEARNING OUTCOMES

**C12-2-05:** Write electron configurations for elements of the periodic table.

Include: selected elements up to atomic number 36 (krypton)

**C12-2-06:** Relate the electron configuration of an element to its valence electron(s) and its position on the periodic table.

(2.5 hours)

SLO: C12-2-05  
SLO: C12-2-06

### SUGGESTIONS FOR INSTRUCTION

#### Entry-Level Knowledge

In Grade 9 Science (S1-2-05), students drew Bohr atoms for the first 18 elements of the periodic table up to argon. Students should also have an understanding of the arrangement of the elements on the periodic table (S1-2-06, S2-2-01, S2-2-02). In Grade 10 Science (S2-2-01), students were introduced to Lewis dot diagrams.

#### TEACHER NOTES

##### Electron Configurations

The arrangement of electrons in an atom is called the *atom's electron configuration*. Chemists use a combination of numbers and letters to designate the energy levels of electrons within an atom.

- The *numbers* refer to the principal energy levels (1, 2, 3, 4, and so on).
- The *letters* refer to the energy levels (s, p, d, f, g, h, and so on), as shown in the following table.

#### General Learning Outcome Connections

- GLO A2:** Recognize that scientific knowledge is based on evidence, models, and explanations, and evolves as new evidence appears and new conceptualizations develop.
- GLO D3:** Understand the properties and structures of matter, as well as various common manifestations and applications of the actions and interactions of matter.
- GLO D4:** Understand how stability, motion, forces, and energy transfers and transformations play a role in a wide range of natural and constructed contexts.
- GLO E1:** Describe and appreciate the similarity and diversity of forms, functions, and patterns within the natural and constructed world.

**SKILLS AND ATTITUDES OUTCOMES**

**C12-0-U1:** Use appropriate strategies and skills to develop an understanding of chemical concepts.

*Examples: analogies, concept frames, concept maps, manipulatives, particulate representations, role-plays, simulations, sort-and-predict frames, word cycles . . .*

**C12-0-U2:** Demonstrate an understanding of chemical concepts.

*Examples: use accurate scientific vocabulary, explain concepts to others, compare and contrast concepts, apply knowledge to new situations and/or contexts, create analogies, use manipulatives . . .*

Summary of Energy Levels and Sublevels			
Principal Quantum Number ( $n$ )	Sublevels Present (Types of Orbitals)	Number of Orbitals Related to Sublevel	Total Number of Orbitals Related to Principal Energy Level ( $n^2$ )
1	s	1	1
2	s p	1 3	4
3	s p d	1 3 5	9
4	s p d f	1 3 5 7	16

Three principles or rules define how electrons can be arranged in an atom's orbital.

### 1. The Aufbau Principle

The *Aufbau principle* (derived from the German, *aufbauen*, which means to build up) was proposed by Danish physicist Neils Bohr (1885–1962). The Aufbau principle states that each electron occupies the lowest energy orbital available. The first step is for students to learn the sequence of atomic orbitals from lowest energy to highest energy, as shown in the following diagram.

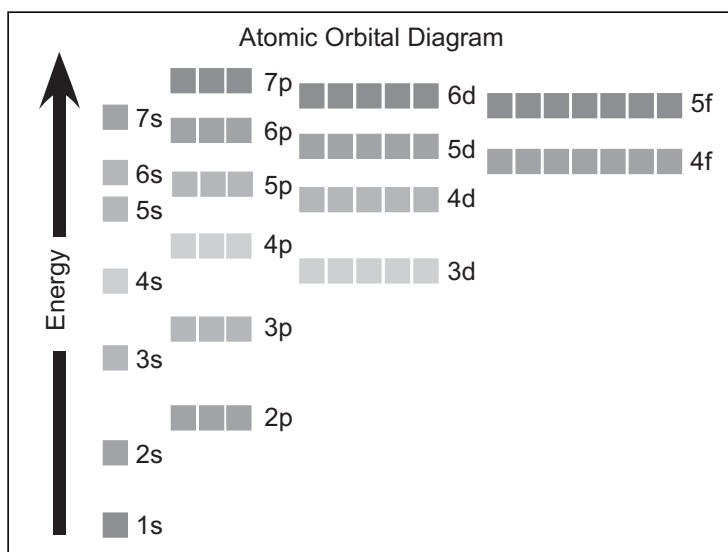

## Topic 2: Atomic Structure

### SPECIFIC LEARNING OUTCOMES

**C12-2-05:** Write electron configurations for elements of the periodic table.

Include: selected elements up to atomic number 36 (krypton)

**C12-2-06:** Relate the electron configuration of an element to its valence electron(s) and its position on the periodic table.

(continued)

In the previous diagram, each box represents an atomic orbital. Each energy level ( $n1, n2, n3, n4$ ) has one or more sublevels, referred to as s, p, d, f, g, h, and so on. All orbitals in the same sublevel have the same energy. For example, the electrons in the 2p sublevel have the same amount of energy in that sublevel. The energy sublevels within a principal energy level have different energies. The 2s orbital has a lower energy than 2p orbital. Orbitals related to energy sublevels within one principal energy level can overlap orbitals related to energy sublevels within another principal level. For example, the 4s orbital has a lower energy than the 3d orbitals.

### 2. The Pauli Exclusion Principle

Proposed by Austrian physicist Wolfgang Pauli (1900–1958), the *Pauli exclusion principle* states that a maximum of two electrons may occupy a single atomic orbital, but only if the electrons have opposite spins. Pauli proposed this principle after observing atoms in excited states. The atomic orbital containing two electrons with opposite spins is written as  $\uparrow\downarrow$ .

### 3. Hund's Rule

Proposed by German physicist Friedrich Hund (1896–1997), *Hund's rule* states that single electrons with the same spin must occupy each equal-energy orbital before additional electrons with opposite spins can occupy the same orbitals. For example, the three 2p orbitals would be filled as shown below.

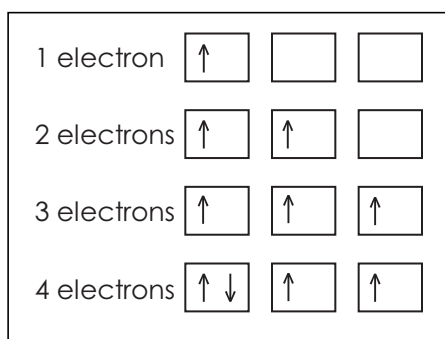

**SKILLS AND ATTITUDES OUTCOMES**

**C12-0-U1:** Use appropriate strategies and skills to develop an understanding of chemical concepts.

*Examples: analogies, concept frames, concept maps, manipulatives, particulate representations, role-plays, simulations, sort-and-predict frames, word cycles . . .*

**C12-0-U2:** Demonstrate an understanding of chemical concepts.

*Examples: use accurate scientific vocabulary, explain concepts to others, compare and contrast concepts, apply knowledge to new situations and/or contexts, create analogies, use manipulatives . . .*

A teaching aid that students can use to write the correct order for electron configurations can be set up as a diagram, as shown below.

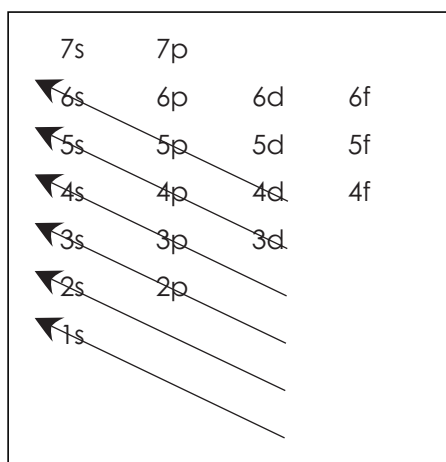

Starting at the base of the diagram, the orbitals are filled by following the direction of the arrows in this manner: 1s, 2s, 2p, 3s, 3p, 4s, 3d, 4p, 5s, 4d, 5p, 6s, and so on.

**Learning Activities: Electron and Valence Configurations**

1. Ask students to write the electronic configuration using noble gas notation. For example, the complete electron configuration for aluminum is  $1s^2 2s^2 2p^6 3s^2 3p^1$ . Using the noble gas notation, the electron configuration for aluminum would be written as  $[\text{Ne}] 3s^2 3p^1$ .
2. Show students how the modern periodic table has been designed according to the structure of the atom with respect to valence electrons and the chemical reactivity of elements.

Provide students with Appendix 2.5: Blank Periodic Table of the Elements and have them write in the valence electrons and the orbital that is being completed. Once the table is complete, the organization of the table should be apparent.

$2s^1$	$2s^2$	$2s^2$ $2p^1$	$2s^2$ $2p^2$	$2s^2$ $2p^3$	etc.
--------	--------	------------------	------------------	------------------	------

Periodic tables indicating the electron configurations of elements are available online (see Websites in Learning Resources Links).

**Topic 2:  
Atomic  
Structure**

---

**SPECIFIC LEARNING OUTCOMES**

**C12-2-05:** Write electron configurations for elements of the periodic table.

Include: selected elements up to atomic number 36 (krypton)

**C12-2-06:** Relate the electron configuration of an element to its valence electron(s) and its position on the periodic table.

(continued)

---

3. Students can play Electron Configuration Bingo. Hand out the symbols of the elements on a bingo card and call out electron configurations. For example, call out  $1s^2$ , and have students cover up He.

**Laboratory Activity**

Have students perform a small-scale experiment on electron configurations of atoms and ions (see Waterman and Thompson 73–76).

**SUGGESTIONS FOR ASSESSMENT**

---

**Paper-and-Pencil Tasks**

1. Ask students to write the complete electronic configuration and the valence configuration for elements up to and including krypton.
2. Have students identify the valence configuration from an element's position on the periodic table.

**Concept Development**

Have students “think about and explain the analogy between Hund’s rule and the behaviour of total strangers as they board an empty bus” (Dingrando, et al., *Glencoe Chemistry: Matter and Change, Teacher Wraparound Edition* 137).

**Journal Writing**

Ask students to write a report

... in which they speculate about flying a spacecraft to a planet in a different solar system. In the new solar system, they discover that each atomic orbital of the planet’s solid, liquid, and gaseous matter may contain up to three electrons rather than just two. Their speculation should focus on the characteristics of the elements on this new planet. (Dingrando, et al., *Glencoe Chemistry: Matter and Change, Teacher Wraparound Edition* 140)

**SKILLS AND ATTITUDES OUTCOMES**

**C12-0-U1:** Use appropriate strategies and skills to develop an understanding of chemical concepts.

*Examples: analogies, concept frames, concept maps, manipulatives, particulate representations, role-plays, simulations, sort-and-predict frames, word cycles . . .*

**C12-0-U2:** Demonstrate an understanding of chemical concepts.

*Examples: use accurate scientific vocabulary, explain concepts to others, compare and contrast concepts, apply knowledge to new situations and/or contexts, create analogies, use manipulatives . . .*

**LEARNING RESOURCES LINKS**

*Chemistry* (Chang 285, 292)

*Chemistry* (Zumdahl and Zumdahl 309, 319)

*Chemistry: The Molecular Nature of Matter and Change* (Silberberg 296, 301)

*Glencoe Chemistry: Concepts and Applications* (Phillips, Strozak, and Wistrom 235, 238, 244)

*Glencoe Chemistry: Matter and Change* (Dingrando, et al. 135, 140, 160)

*Glencoe Chemistry: Matter and Change, Teacher Wraparound Edition* (Dingrando, et al. 137, 140)

*Prentice Hall Chemistry* (Wilbraham, et al. 131, 133, 164)

**Investigation**

*Prentice Hall Chemistry: Small-Scale Chemistry Laboratory Manual* (Waterman and Thompson)

Experiment 10: Electron Configurations of Atoms and Ions, 73–76

**Websites**

The ChemCollective. “Periodic Table.” *Applets*.

<[www.chemcollective.org/applets/pertable.php](http://www.chemcollective.org/applets/pertable.php)> (1 Feb. 2012).

ScienceGeek.net. “Printable Periodic Tables.” *Other Resources*.

<[www.sciencegeek.net/tables/tables.shtml](http://www.sciencegeek.net/tables/tables.shtml)> (1 Feb. 2012).

**Appendix**

Appendix 2.5: Blank Periodic Table of the Elements

**Selecting Learning Resources**

For additional information on selecting learning resources for Grade 11 and Grade 12 Chemistry, see the Manitoba Education website at <[www.edu.gov.mb.ca/k12/learnres/bibliographies.html](http://www.edu.gov.mb.ca/k12/learnres/bibliographies.html)>.

## Topic 2: Atomic Structure

### SPECIFIC LEARNING OUTCOME

**C12-2-07:** Identify and account for periodic trends among the properties of elements, and relate the properties to electron configuration.

Include: atomic radii, ionic radii, ionization energy, and electronegativity

(3 hours)

SLO: C12-2-07

### SUGGESTIONS FOR INSTRUCTION

#### Prior Knowledge

Electronegativity was briefly discussed in Grade 11 Chemistry (C11-4-02). Students learned about this concept in order to explain the polarity and subsequent function of the water molecule in the solution process. In Grade 10 Science (S2-2-02), students were introduced to Lewis dot diagrams as a method of illustrating atomic structure in both ionic and simple covalent compounds.

#### Activating Activity

Have students identify the first ionization energies of the first 36 elements of the periodic table (H to Kr). Students should then graph the atomic number versus ionization energy for each element. The points for each element of a period should be connected with a straight line so that there are four curves on the graph. Students will use this graph to determine the periodic and group trends of the first ionization energies (Jenkins, et al. 54–56). Also see Appendix C2: The Elements (Jenkins, et al. 632–633), or Appendix C, Table C–6: Properties of Elements (Dingrando, et al. 914–916).

Students could repeat this activating activity using atomic radii and ionic radii data for the first 36 elements to help them determine the respective trends.

#### TEACHER NOTES

Most chemistry texts provide an explanation of period and group trends for atomic radii, ionization energies, and ionic radii. Encourage students to use their understanding of nuclear charge and electron configurations to explain the trends, rather than simply memorizing them.

#### General Learning Outcome Connections

- GLO C2:** Demonstrate appropriate scientific skills when seeking answers to questions.
- GLO C5:** Demonstrate curiosity, skepticism, creativity, open-mindedness, accuracy, precision, honesty, and persistence, and appreciate their importance as scientific and technological habits of mind.
- GLO D3:** Understand the properties and structures of matter, as well as various common manifestations and applications of the actions and interactions of matter.
- GLO D4:** Understand how stability, motion, forces, and energy transfers and transformations play a role in a wide range of natural and constructed contexts.
- GLO E1:** Describe and appreciate the similarity and diversity of forms, functions, and patterns within the natural and constructed world.



**SKILLS AND ATTITUDES OUTCOMES**

**C12-0-U1:** Use appropriate strategies and skills to develop an understanding of chemical concepts.

*Examples: analogies, concept frames, concept maps, manipulatives, particulate representations, role-plays, simulations, sort-and-predict frames, word cycles . . .*

**C12-0-S5:** Collect, record, organize, and display data using an appropriate format.

*Examples: labelled diagrams, graphs, multimedia applications, software integration, probeware . . .*

**C12-0-S7:** Interpret patterns and trends in data, and infer and explain relationships.

---

**Trends in Atomic Radii****■ Periodic Trends in Atomic Radii**

The atomic radii generally decrease across a period from left to right. Since each additional electron is added to the same principal energy level, the additional electrons are not shielded from the increasingly positive nucleus. The increased nuclear charge pulls the valence electrons closer to the nucleus, reducing the atomic radius.

**■ Group Trends in Atomic Radii**

The atomic radii generally increase as you move down a group. The outermost orbital increases in size, shielding the valence electrons from the pull of the nucleus. These factors overpower the increased pull of the more positive nucleus on the valence electrons, causing the atomic radius to increase.

**Trends in Ionization Energy**

*Ionization energy* is the energy required to remove an electron from an atom in its gaseous state. These values indicate how strongly an atom's nucleus holds onto its valence electrons. High ionization energy values indicate the atom has a strong hold on the electrons. Low ionization energy values indicate the atom has a weak hold on the electrons. Atoms with high ionization values are unlikely to lose electrons and form positive ions.

**■ Periodic Trends in First Ionization Energies**

The first ionization energy generally increases across a period from left to right. For example, lithium has a low first ionization energy, indicating it will easily lose an electron to form the  $\text{Li}^+$  ion. The lithium atom has one valence electron, and this electron is easily removed from its atom. As you move across the period, it becomes increasingly harder to remove a valence electron from the atom. The reason for this is that the increased nuclear charge of each successive element produces an increased hold on the valence electrons, thereby increasing the ionization energies. The stronger nuclear charge makes it harder to remove a valence electron, as the electrons are pulled closer to the positively charged nucleus. Therefore, neon, which is located at the end of the period, has a high first ionization energy, indicating it will be unlikely to lose an electron to form  $\text{Ne}^+$  ion. Neon has a stable outer energy level (8 electrons), so it does not want to give up an electron readily.

## Topic 2: Atomic Structure

### SPECIFIC LEARNING OUTCOME

**C12-2-07:** Identify and account for periodic trends among the properties of elements, and relate the properties to electron configuration.

Include: atomic radii, ionic radii, ionization energy, and electronegativity

(continued)

#### ■ Periodic Trends in Successive Ionization Energies

The energy required for each successive ionization energy increases across a period from left to right, as shown in Table 6-2: Successive Ionization Energies for the Period 2 Elements (Dingrando, et al., *Chemistry: Matter and Change* 168). The primary reason for this is that the increase in positive charge binds the electrons more strongly.

The table also shows that for each element, the energy required for a specific ionization displays a significant increase. The reason for this is that atoms tend to lose or gain electrons in order to acquire a full energy level because this is the most stable state. The energy jump occurs when a core electron, as opposed to a valence electron, is being removed.

*Example:*

Sodium atom (with 1 valence electron)

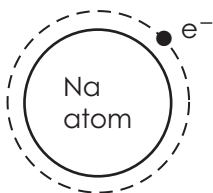

500 kJ/mol energy needed to remove the 1 valence electron

Sodium ion (no valence electrons)

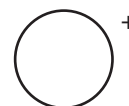

4560 kJ/mol energy needed to remove the 1 electron from the stable energy level  $2s^22p^6$

#### ■ Group Trends in Ionization Energies

The ionization energies decrease as you move down a group. The increasing atomic size pushes the valence electrons further away from the nucleus. Consequently, it takes less energy to remove the electron because the strength of attraction is less.

**SKILLS AND ATTITUDES OUTCOMES**

**C12-0-U1:** Use appropriate strategies and skills to develop an understanding of chemical concepts.

*Examples: analogies, concept frames, concept maps, manipulatives, particulate representations, role-plays, simulations, sort-and-predict frames, word cycles . . .*

**C12-0-S5:** Collect, record, organize, and display data using an appropriate format.

*Examples: labelled diagrams, graphs, multimedia applications, software integration, probeware . . .*

**C12-0-S7:** Interpret patterns and trends in data, and infer and explain relationships.

---

**Trends in Ionic Radii**

When atoms lose electrons to form positive ions (cations) they always get smaller. Two factors lead to the reduction in size. First, the lost valence electron may lead to a completely empty orbital. Second, the electron shielding is reduced, allowing the nucleus to pull the electrons closer to the nucleus.

When atoms gain electrons to form negative ions (anions) they always get larger. The electron shielding increases, pushing the electrons farther from the nucleus.

**■ Periodic Trends in Ionic Radii**

The size of positive ions decrease as you move across a period from left to right, and the size of negative ions decrease as you move across a period from left to right.

**■ Group Trends in Ionic Radii**

The ionic radii of both positive and negative ions increase as you move down a group.

**Trends in Electronegativity**

*Electronegativity* is the ability of an atom in a molecule to attract electrons to itself. The first and most widely used electronegativity scale was developed by Linus Pauling, who based his scale on thermochemical data. Many chemistry texts contain Pauling's values. Robert Mulliken, in 1936, developed an approach to electronegativity that is based on atomic properties only. The Allred-Rochow scale, proposed by A. L. Allred and E. G. Rochow, is based upon the electrostatic force of attraction between the nucleus and the valence electrons. This scale is included in Appendix 2.6: Table of Electronegativity Values. Other tables could also be used and are available online.

*Sample Website:*

Chemistry@Davidson. "Electronegativity: Pauling, Allred-Rochow, and Mulliken-Jaffé." *Dr. Nutt's CHE 115 Course*. <[www.chm.davidson.edu/ronutt/che115/electroneg.htm](http://www.chm.davidson.edu/ronutt/che115/electroneg.htm)> (8 Feb. 2012).

This website presents the three different electronegativity scales: Pauling, Allred-Rochow, and Mulliken-Jaffé.

## Topic 2: Atomic Structure

### SPECIFIC LEARNING OUTCOME

**C12-2-07:** Identify and account for periodic trends among the properties of elements, and relate the properties to electron configuration.

Include: atomic radii, ionic radii, ionization energy, and electronegativity

(continued)

### Electronegativity and Bond Type

Learning outcome C12-2-07 restricts the examples to binary compounds. Most chemistry texts will have a periodic table that contains electronegativity values for each element. By taking the difference between the values for each element, students will be able to predict the type of bonding that occurs between the atoms. Ask students to identify only whether the bonds are non-polar covalent, moderately polar covalent, very polar covalent, or ionic, according to the following table. It is not necessary for students to specify the percent character, even though some texts provide percent values.

Electronegativity Differences and Predicted Bond Character		
Electronegativity Difference	Predicted Bond Type	Examples
0.0 – 0.4	Non-polar covalent	O–O (0.0)
0.4 – 1.0	Moderately polar covalent	SCl <sub>2</sub> (3.16–2.58)
1.0 – 2.0	Very polar covalent	CaS (2.58–1.00)
≥ 2.0	Ionic	KCl (3.16–0.82)

### Predicting Type of Bonding That Occurs in Atoms

Give students both a periodic table that contains the electronegativity values (see Appendix 2.6: Table of Electronegativity Values) and the above table without the examples. Then provide them with the formulae of various binary compounds and have them predict the bond type.

*Example:*

What type of bond would occur in a molecule of LiF?

*Solution:*

From the electronegativity values, Li has a value of 0.97 and F has a value of 4.10. The difference between 4.10 and 0.97 is 3.13. This would indicate that the bond between Li and F is ionic in character.

See Appendix 2.7A: Electronegativities (BLM) for sample problems. A teacher key is provided in Appendix 2.7B.

**SKILLS AND ATTITUDES OUTCOMES**

**C12-0-U1:** Use appropriate strategies and skills to develop an understanding of chemical concepts.

*Examples: analogies, concept frames, concept maps, manipulatives, particulate representations, role-plays, simulations, sort-and-predict frames, word cycles . . .*

**C12-0-S5:** Collect, record, organize, and display data using an appropriate format.

*Examples: labelled diagrams, graphs, multimedia applications, software integration, probeware . . .*

**C12-0-S7:** Interpret patterns and trends in data, and infer and explain relationships.

---

**Multimedia Presentation**

For a PowerPoint presentation that provides an overview of electrons and their periodic trends, visit the following website.

*Sample Website:*

ScienceGeek.net. "AP Chemistry Powerpoints." *AP Chemistry*.

<[www.sciencegeek.net/APchemistry/Powerpoints.shtml](http://www.sciencegeek.net/APchemistry/Powerpoints.shtml)> (1 Feb. 2012).

**Laboratory Activity**

Students can perform a lab activity identifying an element's place in the periodic table based on the element's properties (see Waterman and Thompson 69).

**SUGGESTIONS FOR ASSESSMENT**

---

**Visual Displays**

Students could present the periodic and group trends for atomic radii, ionic radii, ionization energy, and electronegativity in a visual display, such as a poster, pamphlet, or bulletin board exhibit. Each presentation style could be assessed by a predetermined rubric (samples of presentation rubrics are provided in Appendix 11). Students can also fill in the period and group trends on a blank periodic table (see Appendix 2.5).

**Paper-and-Pencil Tasks**

1. Ask students to rank the atomic radii, ionic radii, ionization energy, and electronegativity for a set of elements. Students should also be able to explain their rankings by relating them to electron configuration.
2. Have students draw the periodic and group trends, using directional arrows, on a blank periodic table for atomic radii, ionic radii, ionization energy, and electronegativity. See Appendix 2.5: Blank Periodic Table of the Elements.
3. Provide students with examples of binary compounds and ask them to predict the bond character of the molecule.

**Journal Writing**

Have students summarize the periodic and group trends of atomic radii, ionic radii, ionization energy, and electronegativity.

**Topic 2:  
Atomic  
Structure**

**SPECIFIC LEARNING OUTCOME**

**C12-2-07:** Identify and account for periodic trends among the properties of elements, and relate the properties to electron configuration.

Include: atomic radii, ionic radii, ionization energy, and electronegativity

(continued)

**LEARNING RESOURCES LINKS**



*Chemistry* (Chang 312, 315, 319, 357)

*Chemistry* (Zumdahl and Zumdahl 327, 332, 353)

*Chemistry: The Molecular Nature of Matter and Change* (Silberberg 294, 305, 309, 320, 351)

*Glencoe Chemistry: Concepts and Applications* (Phillips, Strozak, and Wistrom 258, 260, 303)

*Glencoe Chemistry: Matter and Change* (Dingrando, et al. 163, 165, 167, 168, 914–916)

*McGraw-Hill Ryerson Chemistry, Combined Atlantic Edition* (Mustoe, et al. 174)

*McGraw-Hill Ryerson Inquiry into Chemistry* (Chastko, et al. 36)

*Nelson Chemistry 11, Ontario Edition* (Jenkins, et al., 51, 54–56, 57, 632–633)

*Nelson Chemistry 12, Ontario Edition* (van Kessel, et al. 251)

*Nelson Chemistry 12: College Preparation, Ontario Edition* (Davies, et al. 40)

*Prentice Hall Chemistry* (Wilbraham, et al. 170, 173, 176, 177)

**Investigations**

*Glencoe Chemistry: Concepts and Applications* (Phillips, Strozak, and Wistrom)  
MiniLAB 8.1: What's periodic about atomic radii? 262

*Nelson Chemistry 11, Ontario Edition* (Jenkins, et al.)  
Activity 1.5.1: Graphing First Ionization Energy, 54  
Activity 1.5.2: Graphing Electronegativity, 57

*Prentice Hall Chemistry* (Wilbraham, et al.)  
Small-Scale LAB 6: Periodicity in Three Dimensions, 179  
Quick LAB 6: Periodic Trends in Ionic Radii, 175

*Prentice Hall Chemistry: Small-Scale Chemistry Laboratory Manual* (Waterman and Thompson)  
Experiment 9: A Periodic Table Logic Problem, 69

**SKILLS AND ATTITUDES OUTCOMES**

**C12-0-U1:** Use appropriate strategies and skills to develop an understanding of chemical concepts.

*Examples: analogies, concept frames, concept maps, manipulatives, particulate representations, role-plays, simulations, sort-and-predict frames, word cycles . . .*

**C12-0-S5:** Collect, record, organize, and display data using an appropriate format.

*Examples: labelled diagrams, graphs, multimedia applications, software integration, probeware . . .*

**C12-0-S7:** Interpret patterns and trends in data, and infer and explain relationships.

---

**Websites**

Chemistry@Davidson. "Electronegativity: Pauling, Allred-Rochow, and Mulliken-Jaffé." *Dr. Nutt's CHE 115 Course*.  
<[www.chm.davidson.edu/ronutt/che115/electroneg.htm](http://www.chm.davidson.edu/ronutt/che115/electroneg.htm)> (8 Feb. 2012).

ScienceGeek.net. "AP Chemistry Powerpoints." *AP Chemistry*.  
<[www.sciencegeek.net/APchemistry/Powerpoints.shtml](http://www.sciencegeek.net/APchemistry/Powerpoints.shtml)> (1 Feb. 2012).

**Appendices**

Appendix 2.5: Blank Periodic Table of the Elements

Appendix 2.6: Table of Electronegativity Values

Appendix 2.7A: Electronegativities (BLM)

Appendix 2.7B: Electronegativities (Teacher Key)

**Selecting Learning Resources**

For additional information on selecting learning resources for Grade 11 and Grade 12 Chemistry, see the Manitoba Education website at <[www.edu.gov.mb.ca/k12/learnres/bibliographies.html](http://www.edu.gov.mb.ca/k12/learnres/bibliographies.html)>.





# TOPIC 2: ATOMIC STRUCTURE

## APPENDICES

---

Appendix 2.1: Spectral Lines	3
Appendix 2.2: Gas Discharge Tubes (BLM)	5
Appendix 2.3: Flaming Salts (Demonstration)	6
Appendix 2.4: Observing Continuous Spectra and Line Spectra	8
Appendix 2.5: Blank Periodic Table of the Elements	9
Appendix 2.6: Table of Electronegativity Values	10
Appendix 2.7A: Electronegativities (BLM)	11
Appendix 2.7B: Electronegativities (Teacher Key)	12



## Appendix 2.1: Spectral Lines

Element	Wavelength (nm)	Colour
Barium	659.5 614.1 585.4 577.7 553.5 455.4	Red Orange Yellow Yellow Green (strong) Blue (strong)
Calcium	445.4 443.4 442.6 396.8 393.3	Blue Blue-violet Violet (strong) Violet (strong) Violet (strong)
Chromium	520.8 520.6 520.4 428.9 427.4 425.4	Green Green Green Violet (strong) Violet (strong) Violet (strong)
Copper	521.8 515.3 510.5	Green Green Green
Hydrogen	656.2 486.1 434.0 410.1	Red Green Blue-violet Violet
Helium	706.5 667.8 587.5 501.5 471.3 388.8	Red Red Orange (strong) Green Blue Violet (strong)
Potassium	404.7 404.4	Violet (strong) Violet (strong)

*continued*

## Appendix 2.1: Spectral Lines (continued)

---

Element	Wavelength (nm)	Colour
Mercury	623.4 579.0 576.9 546.0 435.8	Red Yellow (strong) Yellow (strong) Green (strong) Blue-violet
Lithium	670.7 610.3 460.3	Red (strong) Orange Violet
Sodium	589.5 588.9 568.8 568.2	Yellow (strong) Yellow (strong) Green Green
Neon	640.2 585.2 540.0	Orange Yellow Green
Strontium	496.2 487.2 483.2 460.7 430.5 421.5 407.7	Blue-green Blue Blue Blue (strong) Blue-violet Violet Violet

**Appendix 2.2: Gas Discharge Tubes (BLM)**

**Hydrogen**

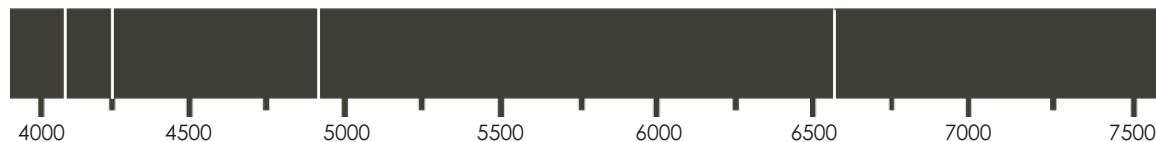

Emission Spectrum of Hydrogen

Element \_\_\_\_\_

Element \_\_\_\_\_

Element \_\_\_\_\_

Element \_\_\_\_\_

Element \_\_\_\_\_

Element \_\_\_\_\_

## Appendix 2.3: Flaming Salts (Demonstration)

---

For this demonstration, ignite a series of salt solutions mixed in methanol and have students observe the colours given off. The demonstration is probably more convincing if all the salts differ only by the metal (e.g., all the salts are chlorides).

### Materials

evaporating dishes or crucibles (1 per salt solution)  
long matches or a lighter  
gloves and goggles  
diffraction gratings or spectrosopes

### Solutions

Prepare saturated salt solutions (60%) mixed in methanol

lithium chloride (LiCl)  
sodium chloride (NaCl)  
potassium chloride (KCl)  
calcium chloride (CaCl<sub>2</sub>)  
strontium chloride (SrCl<sub>2</sub>)  
barium chloride (BaCl<sub>2</sub>)  
copper(II) sulphate (CuSO<sub>4</sub>)  
borax (Na<sub>2</sub>B<sub>4</sub>O<sub>7</sub>)  
sodium carbonate (Na<sub>2</sub>CO<sub>3</sub>)

### Procedure

1. Set the evaporating dishes on a heat/flame-resistant surface.
2. Pour about 10 to 20 mL of each salt solution/methanol mix into separate dishes.
3. Light the salt mixture with a long match or lighter. (Do not drop the match into the solution.)
4. Allow the flames to burn for a few seconds until a consistent, single-coloured flame appears.
5. Record the colours of the flames in a data table.
6. Observe the spectral lines of the flames through a diffraction grating or spectroscope.

## Appendix 2.3: Flaming Salts (Demonstration) (continued)

Data Table

Salt Solutions	Flame Colour
Lithium chloride (LiCl)	Red
Sodium chloride (NaCl)	Yellow
Potassium chloride (KCl)	Lilac
Calcium chloride (CaCl <sub>2</sub> )	Bright orange
Strontium chloride (SrCl <sub>2</sub> )	Red-orange
Barium chloride (BaCl <sub>2</sub> )	Green
Copper(II) sulphate (CuSO <sub>4</sub> )	Green
Borax (Na <sub>2</sub> B <sub>4</sub> O <sub>7</sub> )	Green
Sodium carbonate (Na <sub>2</sub> CO <sub>3</sub> )	Yellow

## Appendix 2.4: Observing Continuous Spectra and Line Spectra

---

### Questions

1. Draw the spectra of an incandescent light bulb and of a fluorescent light bulb.
2. What is the difference between a line spectrum and a continuous spectrum? Draw one of each.
3. Based on your observations in the lab activities, what types of materials produce continuous spectra? What types of materials produce line spectra?
4. Give an example of a light source with
  - a) a continuous spectrum
  - b) a line spectrum
  - c) both a continuous spectrum and a line spectrum
5. Based on your observations, what would you say are some things that all light-emitting sources have in common? How can they differ?
6. Explain why a rainbow is considered to be an example of a continuous spectrum.
7. What do the different colours in a line spectrum represent?
8. Why do different substances show different spectra?
9. Sodium vapour lamps emit a characteristic yellow light. What can you assume about sodium atoms, based on this observation?
10. Explain how atoms produce their characteristic spectral lines. Why are different lines produced instead of just a single line?
11. Which elements produce the largest number of spectral lines? What does this suggest about electron transitions?
12. Spectral lines are fingerprints of elements. Explain what is meant by this statement.





## Appendix 2.6: Table of Electronegativity Values

18	2	He	—	17	9	F	4.10	16	8	O	3.50	15	7	N	3.07	14	6	C	2.50	13	5	B	2.01	1	1	H	2.20
	10	Ne	—		17	F	4.10		8	O	3.50		7	N	3.07		6	C	2.50		5	B	2.01	2	3	Li	0.97
	18	Ar	—		17	Cl	2.83		16	S	2.44		15	P	2.06		14	Si	1.74		13	Al	1.47	3	11	Na	1.01
	36	Kr	—		35	Br	2.74		34	Se	2.48		33	As	2.20		32	Ge	2.02		31	Ga	1.82	4	19	K	0.91
	54	Xe	—		53	I	2.21		52	Te	2.01		51	Sb	1.82		50	Sn	1.72		49	In	1.49	5	37	Rb	0.89
	86	Rn	—		85	At	1.90		84	Po	1.76		83	Bi	1.67		82	Pb	1.55		81	Tl	1.44	6	55	Cs	0.86
	118	Uuo	—						116	Uuh	—		115	Uup	—		114	Uuq	—		113	Uut	—	7	87	Fr	0.86
					</																						

**Appendix 2.7A: Electronegativities (BLM)**

Use the Table of Electronegativity Values to determine the bond type (ionic, polar covalent, non-polar covalent) that would be formed between each of the following elements. Provide the electronegativity difference for each pair.

Elements	Bond Type	Electronegativity Difference
1. Na, Cl		
2. Al, Cl		
3. H, S		
4. K, F		
5. O, O		
6. Mg, S		
7. Li, Br		
8. F, F		

**Appendix 2.7B: Electronegativities (Teacher Key)**

Use the Table of Electronegativity Values to determine the bond type (ionic, polar covalent, non-polar covalent) that would be formed between each of the following elements. Provide the electronegativity difference for each pair. Answers are based on the Allred-Rochow scale.

Elements	Bond Type	Electronegativity Difference
1. Na, Cl	Very polar covalent	$2.83 - 1.01 = 1.82$
2. Al, Cl	Very polar covalent	$2.83 - 1.47 = 1.36$
3. H, S	Non-polar covalent	$2.44 - 2.20 = 0.24$
4. K, F	Ionic	$4.10 - 0.91 = 3.19$
5. O, O	Non-polar covalent	$3.50 - 3.50 = 0$
6. Mg, S	Very polar covalent	$2.44 - 1.23 = 1.21$
7. Li, Br	Very polar covalent	$2.74 - 0.97 = 1.77$
8. F, F	Non-polar covalent	$4.10 - 4.10 = 0$

**TOPIC 3:**  
**CHEMICAL KINETICS**

---



### Topic 3: Chemical Kinetics

- C12-3-01** Formulate an operational definition of *reaction rate*.  
Include: examples of chemical reactions that occur at different rates
- C12-3-02** Identify variables used to monitor reaction rates (i.e., change per unit of time,  $\Delta x / \Delta t$ ).  
*Examples: pressure, temperature, pH, conductivity, colour. . .*
- C12-3-03** Perform a laboratory activity to measure the average and instantaneous rates of a chemical reaction.  
Include: initial reaction rate
- C12-3-04** Relate the rate of formation of a product to the rate of disappearance of a reactant, given experimental rate data and reaction stoichiometry.  
Include: descriptive treatment at the particulate level
- C12-3-05** Perform a laboratory activity to identify factors that affect the rate of a chemical reaction.  
Include: nature of reactants, surface area, concentration, pressure, volume, temperature, and presence of a catalyst
- C12-3-06** Use the collision theory to explain the factors that affect the rate of chemical reactions.  
Include: activation energy and orientation of molecules
- C12-3-07** Draw potential energy diagrams for endothermic and exothermic reactions.  
Include: relative rates, effect of a catalyst, and heat of reaction (enthalpy change)
- C12-3-08** Describe qualitatively the relationship between the factors that affect the rate of chemical reactions and the relative rate of a reaction, using the collision theory.
- C12-3-09** Explain the concept of a reaction mechanism.  
Include: rate-determining step
- C12-3-10** Determine the rate law and order of a chemical reaction from experimental data.  
Include: zero-, first-, and second-order reactions and reaction rate versus concentration graphs

**Suggested Time: 10 hours**

### Topic 3: Chemical Kinetics

#### SPECIFIC LEARNING OUTCOMES

**C12-3-01:** Formulate an operational definition of *reaction rate*.  
Include: examples of chemical reactions that occur at different rates

**C12-3-02:** Identify variables used to monitor reaction rates (i.e., change per unit of time,  $\Delta x/\Delta t$ ).  
*Examples: pressure, temperature, pH, conductivity, colour . . .*

(1 hour)

SLO: C12-3-01  
SLO: C12-3-02

#### SUGGESTIONS FOR INSTRUCTION

##### Activating Activity

Ask students for examples of fast and slow reactions or processes that they encounter in their daily lives. Students may begin with examples of physical changes, such as melting or dissolving. Even though these are not examples of chemical changes, they still reinforce the concept of fast and slow reactions. Try to lead students to consider chemical reactions.

Some examples students may give for fast reactions are explosions, burning gasoline (combustion), precipitation reactions, and neutralization reactions.

Some examples students may give for slow reactions are rusting of metals, baking a cake, ripening of fruit, and growth of a plant.

##### TEACHER NOTES

##### Reaction Rate (C12-3-01)

Chemical kinetics crosses over into many other areas of science and engineering. Rates of metabolic reaction and the progress of reactions involved in growth and bone regeneration are studied by biologists. Automobile engineers want to decrease the rate of rusting of car bodies, while agricultural scientists study the chemical reactions involved in spoilage and decay of foods (see van Kessel, et al. 358).

The speed of any activity (e.g., running, reading, cooking) involves quantifying how much is accomplished in a specific amount of time. We can quantify, or measure, the speed of a chemical reaction (also known as its *reaction rate*).

##### General Learning Outcome Connections

- GLO C2:** Demonstrate appropriate scientific skills when seeking answers to questions.
- GLO C5:** Demonstrate curiosity, skepticism, creativity, open-mindedness, accuracy, precision, honesty, and persistence, and appreciate their importance as scientific and technological habits of mind.
- GLO D3:** Understand the properties and structures of matter, as well as various common manifestations and applications of the actions and interactions of matter.
- GLO E3:** Recognize that characteristics of materials and systems can remain constant or change over time, and describe the conditions and processes involved.
- GLO E3:** Recognize that energy, whether transmitted or transformed, is the driving force of both movement and change, and is inherent within materials and in the interactions among them.



**SKILLS AND ATTITUDES OUTCOMES**

**C12-0-U1:** Use appropriate strategies and skills to develop an understanding of chemical concepts.

*Examples: analogies, concept frames, concept maps, manipulatives, particulate representations, role-plays, simulations, sort-and-predict frames, word cycles . . .*

**C12-0-S5:** Collect, record, organize, and display data using an appropriate format.

*Examples: labelled diagrams, graphs, multimedia applications, software integration, probeware . . .*

Operationally, reaction kinetics describes how fast or slow a reactant disappears or a product forms. At this point, an operational definition will involve reaction time as opposed to reaction rate. (Fast reactions have a short reaction time, while slow reactions take a long time.)

**Demonstrations/Laboratory Activities**

Listed below are a number of demonstrations/lab activities illustrating the concept of reaction rate in a chemical reaction. Perform a few demonstrations to help students understand reaction rates.

**■ Reaction Rate**

React magnesium (Mg) metal with 1.0 mol/L hydrochloric acid (HCl). React another piece of Mg metal with 6.0 mol/L HCl.

Ask students the following questions:

1. What happened?
2. How long did both reactions take?
3. Does it matter how much material you have?
4. How can you measure the rate of the reaction?

**■ Electrolysis Reaction (Extension)**

Generate hydrogen and oxygen by electrolysis in a dish of liquid soap. It will give off bubbles of hydrogen and oxygen gas. Remove the gas generator. Ask students whether a reaction is occurring. (Answers may vary.)

Discuss that this electrolysis reaction (splitting up of water to form hydrogen gas and oxygen gas) is occurring spontaneously but at a slow rate. Ask students how we could increase the rate. (Answers will vary.)

Touch the bubbles with a burning wood splint. (You may wish to have it attached to a metre stick.) The reaction happens quickly. (A loud popping sound results.)

**■ Mass Changes**

Find the mass of uniform pieces of gelatin and then place each piece into a separate beaker. Place different pieces of fruit in each of the beakers except the one beaker that contains only the piece of gelatin (serves as the control). Leave the beakers overnight. In the next class, determine the mass of the pieces of gelatin again. Comment on any observations made (see Chastko 403).

**Topic 3:  
Chemical  
Kinetics**

---

**SPECIFIC LEARNING OUTCOMES**

**C12-3-01:** Formulate an operational definition of *reaction rate*.  
Include: examples of chemical reactions that occur at different rates

**C12-3-02:** Identify variables used to monitor reaction rates (i.e., change per unit of time,  $\Delta x/\Delta t$ ).  
*Examples: pressure, temperature, pH, conductivity, colour . . .*

(continued)

---

**■ Food Spoilage**

Cut an apple into four slices, each with approximately the same surface area of flesh exposed.

- Dip the first slice in water and place it on a surface. The first slice acts as the control.
- Dip the second slice in lemon juice and place it next to the first slice.
- Place the third slice in the refrigerator, or in a small cooler filled with ice.
- Place the fourth slice in a sealable bag, removing as much air as possible.

Compare the four slices after 10, 20, and 30 minutes, and record the amount of browning that occurs on the apple flesh at each time increment. Discuss observations in relation to what the apple was exposed to.

Comment further on observations with the apple slices, this time in terms of the rate at which the browning of the apple occurs in each sample (see van Kessel, et al. 359).

**■ Decomposition Reaction**

Hydrogen peroxide ( $\text{H}_2\text{O}_2$ ) gradually decomposes to form water and oxygen gas. In this situation, the yeast acts on the hydrogen peroxide to speed up the reaction.

Pour 10 mL of hydrogen peroxide into a beaker and record any observations. Add a “pinch” of yeast to the hydrogen peroxide. Stir gently with a toothpick. Record observations. (The hydrogen peroxide is clear and colourless. When the yeast is added to the hydrogen peroxide, bubbles form, and then the mixture starts to foam.)

Instead of using yeast, use manganese dioxide ( $\text{MnO}_2$ ) to speed up the hydrogen peroxide decomposition reaction.

**SKILLS AND ATTITUDES OUTCOMES**

**C12-0-U1:** Use appropriate strategies and skills to develop an understanding of chemical concepts.

*Examples: analogies, concept frames, concept maps, manipulatives, particulate representations, role-plays, simulations, sort-and-predict frames, word cycles . . .*

**C12-0-S5:** Collect, record, organize, and display data using an appropriate format.

*Examples: labelled diagrams, graphs, multimedia applications, software integration, probeware . . .*

**TEACHER NOTES****Monitoring Reaction Rates (C12-3-02)**

*Reaction rate* is change in an observable property over time. The observable property should be selected based upon what can be measured in the laboratory. This could be a colour change, a temperature change, a pressure change, or the appearance of a new substance. Some common methods of measuring reaction rates involve the use of spectrometers, conductivity apparatus, and manometers (or a simple syringe).

Note that concentration cannot be monitored directly. Emphasize that the observable (measurable) properties described in the following examples can be used to determine the change in concentration over time.

- **Pressure**

A manometer can be used to measure a change in pressure when a reaction results in a change in the number of moles of gas. The reaction between zinc and acetic acid, for example, can be monitored by attaching a manometer to a reaction vessel of known volume that is immersed in a constant-temperature bath.

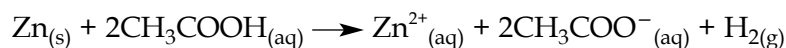

As  $\text{H}_{2(g)}$  is produced, the gas pressure increases (Silberberg 681).

A simpler method would be to use a gas syringe to measure the reaction rate. See diagram below.

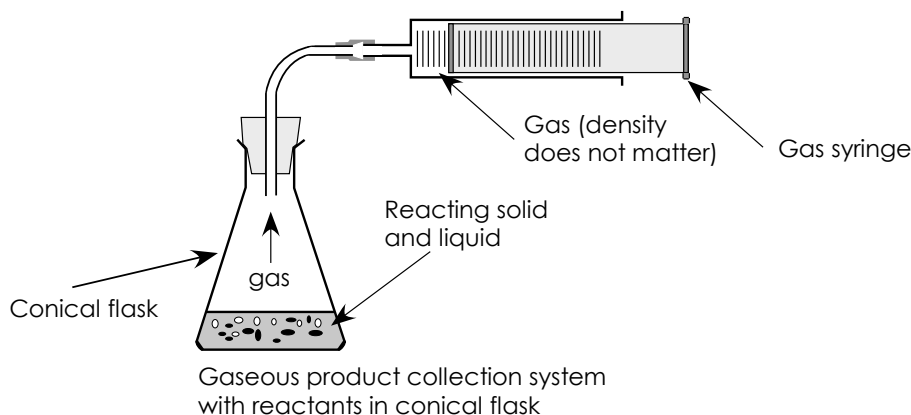

### Topic 3: Chemical Kinetics

#### SPECIFIC LEARNING OUTCOMES

**C12-3-01:** Formulate an operational definition of *reaction rate*.  
Include: examples of chemical reactions that occur at different rates

**C12-3-02:** Identify variables used to monitor reaction rates (i.e., change per unit of time,  $\Delta x/\Delta t$ ).  
*Examples: pressure, temperature, pH, conductivity, colour . . .*

(continued)

#### ■ Temperature

The following reaction can be monitored by temperature.

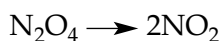

colourless    reddish brown

If a sealed tube of  $\text{NO}_2$ – $\text{N}_2\text{O}_4$  is placed in a cold water bath, the dinitrogen tetroxide ( $\text{N}_2\text{O}_4$ ) becomes predominant. The contents of the tube become lighter in colour.

If another tube containing a similar sample of  $\text{NO}_2$ – $\text{N}_2\text{O}_4$  is placed in a hot water bath, the resulting colour change is a reddish brown, indicating a greater presence of  $\text{NO}_2$ .

A sealed tube of  $\text{NO}_2$ – $\text{N}_2\text{O}_4$  can be left at room temperature so students can make the comparison with the tube in a cold water bath, and then with the tube in a hot water bath.

#### ■ The Concept of pH

A pH meter can be used to measure the change in acidity over time. This data can then be used to determine the concentration of hydrogen (hydronium) ion over time.

#### ■ Conductivity

Electrodes can be placed in the reaction mixture and the increase/decrease in conductivity of the products can be used to measure reaction rate. This method is usually used when non-ionic reactants form ionic products (Silberberg 681).

Reaction rate can be calculated by finding the change in formation of product over time, or by finding the change in consumption of a reactant over time.

$$\text{Rate} = \Delta x / \Delta t \text{ (formation of a product)}$$

$$\text{Rate} = -\Delta x / \Delta t \text{ (consumption of a reactant)}$$

Students may confuse reaction rate and reaction time. Emphasize that *reaction rate* describes a change over time, while *reaction time* is the amount of time it takes for a reaction to occur. The two terms are inversely related, as shown by the previous formulas.

**SKILLS AND ATTITUDES OUTCOMES**

**C12-0-U1:** Use appropriate strategies and skills to develop an understanding of chemical concepts.

*Examples: analogies, concept frames, concept maps, manipulatives, particulate representations, role-plays, simulations, sort-and-predict frames, word cycles . . .*

**C12-0-S5:** Collect, record, organize, and display data using an appropriate format.

*Examples: labelled diagrams, graphs, multimedia applications, software integration, probeware . . .*

- **Colour**

A spectrometer can be used to measure the concentration of a reactant or product that absorbs (or gives off) light of a narrow range of wavelengths. An example of this is

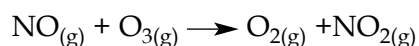

colourless

reddish brown

Known amounts of the reactants are injected into a gas sample tube of known volume, and the rate of  $\text{NO}_{2(g)}$  produced is measured by monitoring the colour over time (Silberberg 680).

## SUGGESTIONS FOR ASSESSMENT

### Journal Writing

Students can make journal entries for fast and slow reactions and state their rationale for each.

Ask students to consider questions such as the following:

- What does *rate* mean?
- How can you measure the rate of a reaction?
- Does a reaction always occur at the same rate? Explain.
- Do all reactions occur at the same rate? Explain.

Ask students to provide examples of

- reactions that have different rates of reaction
- reactions that occur at different rates under different conditions
- processes that cannot be controlled
- processes that can be controlled

### Paper-and-Pencil Tasks

1. Students can complete a Compare and Contrast think sheet for fast reactions versus slow reactions (SYSTH 10.15, 10.24).
2. Students can complete a KWL (Know, Want to Know, Learned) strategy sheet on reaction rate (SYSTH 9.8, 9.24).
3. Given a reaction, students can predict what variable (or property) may be most easily monitored.

**Topic 3:  
Chemical  
Kinetics**

**SPECIFIC LEARNING OUTCOMES**

- C12-3-01:** Formulate an operational definition of *reaction rate*.  
Include: examples of chemical reactions that occur at different rates
- C12-3-02:** Identify variables used to monitor reaction rates (i.e., change per unit of time,  $\Delta x/\Delta t$ ).  
*Examples: pressure, temperature, pH, conductivity, colour . . .*

(continued)

**LEARNING RESOURCES LINKS**



- Chemistry* (Chang 532, 533)
- Chemistry* (Zumdahl and Zumdahl 561)
- Chemistry: The Molecular Nature of Matter and Change* (Silberberg 673, 680, 681)
- Glencoe Chemistry: Matter and Change* (Dingrando, et al. 529)
- McGraw-Hill Ryerson Chemistry*, Combined Atlantic Edition (Mustoe, et al. 463, 466)
- McGraw-Hill Ryerson Inquiry into Chemistry* (Chastko, et al. 404)
- Nelson Chemistry 12*, Ontario Edition (van Kessel, et al., 358, 360, 365)
- Prentice Hall Chemistry* (Wilbraham, et al. 540)

**Investigations**

- Glencoe Chemistry: Matter and Change* (Dingrando, et al.)  
Discovery Lab: Speeding Reactions, 529
- McGraw-Hill Ryerson Inquiry into Chemistry* (Chastko, et al.)  
Launch Lab: Does It Gel? 403
- Nelson Chemistry 12*, Ontario Edition (van Kessel, et al.)  
Slowing the Browning Process, 359
- Prentice Hall Chemistry* (Wilbraham, et al.)  
Inquiring Activity: Temperature and Reaction Rates, 540

**Website**

- Brown, W. P. "Factors Affecting the Speed-Rates of Chemical Reactions."  
*Doc Brown's Chemistry*. 2000–2010.  
<[www.docbrown.info/page03/3\\_31rates.htm](http://www.docbrown.info/page03/3_31rates.htm)> (8 Feb. 2012).

**Selecting Learning Resources**

For additional information on selecting learning resources for Grade 11 and Grade 12 Chemistry, see the Manitoba Education website at <[www.edu.gov.mb.ca/k12/learnres/bibliographies.html](http://www.edu.gov.mb.ca/k12/learnres/bibliographies.html)>.

**SKILLS AND ATTITUDES OUTCOMES**

**C12-0-U1:** Use appropriate strategies and skills to develop an understanding of chemical concepts.

*Examples: analogies, concept frames, concept maps, manipulatives, particulate representations, role-plays, simulations, sort-and-predict frames, word cycles . . .*

**C12-0-S5:** Collect, record, organize, and display data using an appropriate format.

*Examples: labelled diagrams, graphs, multimedia applications, software integration, probeware . . .*

---

**NOTES**

**Topic 3:  
Chemical  
Kinetics**

**SPECIFIC LEARNING OUTCOMES**

**C12-3-03:** Perform a laboratory activity to measure the average and instantaneous rates of a chemical reaction.

Include: initial reaction rate

**C12-3-04:** Relate the rate of formation of a product to the rate of disappearance of a reactant, given experimental rate data and reaction stoichiometry.

Include: descriptive treatment at the particulate level

(2.5 hours)

SLO: C12-3-03  
SLO: C12-3-04

**SUGGESTIONS FOR INSTRUCTION**

**Entry-Level Knowledge**

Students studied the stoichiometry of chemical reactions in Grade 11 Chemistry (Topic 3: Chemical Reactions).

**Laboratory Activity**

Have students perform a lab activity to measure the change in mass of calcium carbonate as it reacts with 3 mol/L hydrochloric acid. See Appendix 3.1: Graphical Determination of Reaction Rate: Lab Activity.

Using the data derived from the lab activity (or data given in Appendix 3.1), students can calculate the average rate and the instantaneous rate of a reaction. Students can use software, such as Excel or Graphical Analysis, to plot data and determine instantaneous rate at time = 0 (initial rate) and at other times. Students can compare the rates and hypothesize why the rates change.

**TEACHER NOTES**

**Average Rate of a Chemical Reaction (C12-3-03)**

The *average rate* of a reaction depends on the time interval chosen. Usually this is calculated by dividing the total consumption (or total production) of a substance by the total time it took for the reaction to occur. Refer to the following graph and sample calculation.

**General Learning Outcome Connections**

**GLO C2:** Demonstrate appropriate scientific skills when seeking answers to questions.

**GLO C5:** Demonstrate curiosity, skepticism, creativity, open-mindedness, accuracy, precision, honesty, and persistence, and appreciate their importance as scientific and technological habits of mind.

**GLO D3:** Understand the properties and structures of matter, as well as various common manifestations and applications of the actions and interactions of matter.

**GLO D4:** Understand how stability, motion, forces, and energy transfers and transformations play a role in a wide range of natural and constructed contexts.



**SKILLS AND ATTITUDES OUTCOMES**

**C12-0-S5:** Collect, record, organize, and display data using an appropriate format.

Examples: labelled diagrams, graphs, multimedia applications, software integration, probeware . . .

**C12-0-S6:** Estimate and measure accurately using Système International (SI) and other standard units.

Include: SI conversions and significant figures

**C12-0-S7:** Interpret patterns and trends in data, and infer and explain relationships.

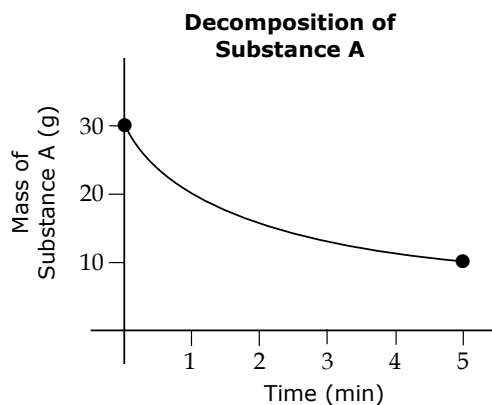

$$\text{Average rate} = \frac{\text{change in the amount of substance A}}{\text{change in time}} = \frac{30 \text{ g} - 10 \text{ g}}{0 \text{ min} - 5 \text{ min}} = 4 \text{ g/min}$$

**Instantaneous Rate of Chemical Reaction (C12-3-03)**

The *instantaneous rate* is the rate of reaction that occurs at a particular instant in time. To calculate this rate, a tangent line is drawn to the point of time on the graph (particular instant of time), and the slope of this line is then calculated.

Refer to the following graph and sample calculation for determining the instantaneous rate at 1 minute.

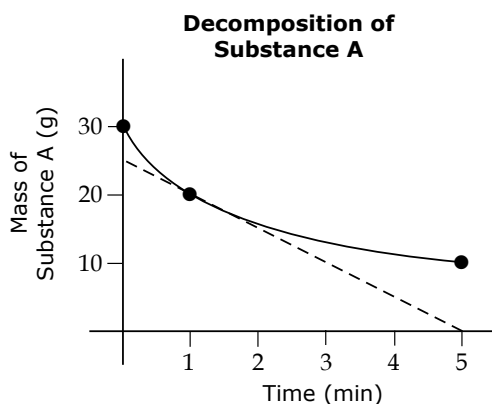

$$\begin{aligned} \text{Slope} &= \frac{\text{change in the amount of substance A}}{\text{change in time}} = \frac{25 \text{ g} - 0 \text{ g}}{0 \text{ min} - 5 \text{ min}} \\ &= -5 \text{ g/min at } t = 1 \text{ min} \end{aligned}$$

### Topic 3: Chemical Kinetics

#### SPECIFIC LEARNING OUTCOMES

**C12-3-03:** Perform a laboratory activity to measure the average and instantaneous rates of a chemical reaction.

Include: initial reaction rate

**C12-3-04:** Relate the rate of formation of a product to the rate of disappearance of a reactant, given experimental rate data and reaction stoichiometry.

Include: descriptive treatment at the particulate level

(continued)

#### Paper Laboratory Activity

If students need additional practice, they can create sample plots with given data. Two sample assignments (with answer keys) are provided in Appendix 3.2A: Chemical Kinetics: Assignment 1 and Appendix 3.3A: Chemical Kinetics: Assignment 2. From the plotted data, students calculate average rates and determine instantaneous rates. They also compare rates and discover that the rate of consumption of each reactant and the formation of each product is related to the stoichiometry of the reaction.

#### TEACHER NOTES

##### Rate and Reaction Stoichiometry (C12-3-04)

The concept of rate and reaction stoichiometry should be introduced carefully. Diagrams of molecules would help students to understand reaction rate at the particulate (molecular) level.

*Example:*

For the reaction  $\text{N}_2 + 3\text{H}_2 \rightarrow 2\text{NH}_3$ , the coefficient in front of the substance determines the rate of consumption or production of that substance, if the initial rate of  $\text{N}_2$  is known.

At the particulate level, this reaction would be expressed as follows:

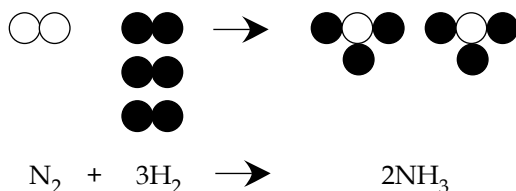

Students should recognize that for every  $\text{N}_2$  molecule, three  $\text{H}_2$  molecules need to be consumed. This means that the rate of consumption of  $\text{H}_2$  is three times the rate of consumption of  $\text{N}_2$ . In addition, for every molecule of  $\text{N}_2$  that is consumed, the rate of production of  $\text{NH}_3$  molecules is doubled.

## SKILLS AND ATTITUDES OUTCOMES

**C12-0-S5:** Collect, record, organize, and display data using an appropriate format.

*Examples: labelled diagrams, graphs, multimedia applications, software integration, probeware . . .*

**C12-0-S6:** Estimate and measure accurately using Système International (SI) and other standard units.

*Include: SI conversions and significant figures*

**C12-0-S7:** Interpret patterns and trends in data, and infer and explain relationships.

Another way to state this is that  $N_2$  is consumed at one-third the rate that  $H_2$  is consumed and at half the rate that  $NH_3$  is produced.

If the rate of one of the species is known, the rates of the other species can be determined from the reaction stoichiometry.

If the rate of consumption of nitrogen is given as

$$\text{Rate} = -\frac{\Delta[N_2]}{\Delta t}$$

then the following is also true:

$$\text{Rate} = -\frac{\Delta[N_2]}{\Delta t} = -\frac{1}{3} \frac{\Delta[H_2]}{\Delta t} = \frac{1}{2} \frac{\Delta[NH_3]}{\Delta t}$$

*Sample Problem:*

For the reaction  $N_2 + 3H_2 \rightarrow 2NH_3$ , if hydrogen reacts at a rate of  $1.5 \text{ mol/L} \cdot \text{s}$ , what is the rate of formation of ammonia?

*Solution:*

Calculate the rate in a manner similar to how stoichiometry was used to determine moles of product formed. Use the ratio of the coefficients to determine the ratio of rates.

$$\begin{aligned} \text{Rate } NH_3 \text{ formation} &= 1.5 \text{ mol/L} \cdot \text{s } H_2 \left( \frac{2NH_3}{3H_2} \right) \\ &= 1.0 \text{ mol/L} \cdot \text{s } NH_3 \end{aligned}$$

**Topic 3:  
Chemical  
Kinetics**

---

**SPECIFIC LEARNING OUTCOMES**

- C12-3-03:** Perform a laboratory activity to measure the average and instantaneous rates of a chemical reaction.  
Include: initial reaction rate
- C12-3-04:** Relate the rate of formation of a product to the rate of disappearance of a reactant, given experimental rate data and reaction stoichiometry.  
Include: descriptive treatment at the particulate level

(continued)

---

**Animations/Simulations**

Simulations, such as those on the following websites, allow students to determine the rate of reaction at a given point in time. They also show the effect of concentration change, the rate of a chemical reaction, and the determination of stoichiometric coefficients.

*Sample Websites:*

Blauch, David N. *Virtual Chemistry Experiments: Chemical Kinetics*. 2001, 2009. *Chemistry@Davidson*. <[www.chm.davidson.edu/vce/kinetics/index.html](http://www.chm.davidson.edu/vce/kinetics/index.html)> (8 Feb. 2012).

See simulations on the following topics:

- Reaction Rates
- Rate of Reaction

Chemical Education Research Group, Iowa State University. "Chemistry Experiment Simulations and Conceptual Computer Animations." *Chemical Education*. <<http://group.chem.iastate.edu/Greenbowe/sections/projectfolder/simDownload/index4.html>> (22 Nov. 2012).

In the Kinetics section, download and unzip the following animation:

- NO + O<sub>3</sub> Bimolecular Collision

**SUGGESTIONS FOR ASSESSMENT**

---

**Laboratory Skills**

A checklist can be used to assess students on the following lab skills:

- collecting and interpreting data
- making and using graphs
- observing, predicting, and recognizing cause and effect

**SKILLS AND ATTITUDES OUTCOMES**

**C12-0-S5:** Collect, record, organize, and display data using an appropriate format.

*Examples: labelled diagrams, graphs, multimedia applications, software integration, probeware . . .*

**C12-0-S6:** Estimate and measure accurately using Système International (SI) and other standard units.

*Include: SI conversions and significant figures*

**C12-0-S7:** Interpret patterns and trends in data, and infer and explain relationships.

**Paper-and-Pencil Tasks**

1. Have students describe pictorially what is happening at the particulate level when a reactant is consumed and a product is formed in a chemical reaction.
2. Have students solve problems on experimental rate data and reaction stoichiometry. See Appendix 3.4A: Chemical Kinetics Problems and Appendix 3.4B: Chemical Kinetics Problems (Answer Key).

**LEARNING RESOURCES LINKS**

*Chemistry* (Chang 534, 537)

*Chemistry* (Zumdahl and Zumdahl 561)

*Chemistry: The Molecular Nature of Matter and Change* (Silberberg 675)

*Glencoe Chemistry: Matter and Change* (Dingrando, et al. 531, 546)

*Nelson Chemistry 12, Ontario Edition* (van Kessel, et al., 360, 362)

*Prentice Hall Chemistry* (Wilbraham, et al. 575)

**Investigation**

*Nelson Chemistry 12, Ontario Edition* (van Kessel, et al.)

Lab Exercise 6.1.1: Determining a Rate of Reaction, 401

**Websites**

Blauch, David N. "Rate of Reaction." *Virtual Chemistry Experiments: Chemical Kinetics*. 2001, 2009. Chemistry@Davidson. <[www.chm.davidson.edu/vce/kinetics/RateOfReaction.html](http://www.chm.davidson.edu/vce/kinetics/RateOfReaction.html)> (8 Feb. 2012).

Simulations: Reaction Rates  
Rate of Reaction

Chemical Education Research Group, Iowa State University. "Chemistry Experiment Simulations and Conceptual Computer Animations." *Chemical Education*. <<http://group.chem.iastate.edu/Greenbowe/sections/projectfolder/simDownload/index4.html>> (22 Nov. 2012).

Animation: NO + O<sub>3</sub> Bimolecular Collision

**Topic 3:  
Chemical  
Kinetics**

---

**SPECIFIC LEARNING OUTCOMES**

- C12-3-03:** Perform a laboratory activity to measure the average and instantaneous rates of a chemical reaction.  
Include: initial reaction rate
- C12-3-04:** Relate the rate of formation of a product to the rate of disappearance of a reactant, given experimental rate data and reaction stoichiometry.  
Include: descriptive treatment at the particulate level

(continued)

---

**Appendices**

- Appendix 3.1: Graphical Determination of Reaction Rate: Lab Activity
- Appendix 3.2A: Chemical Kinetics: Assignment 1
- Appendix 3.2B: Chemical Kinetics: Assignment 1 (Answer Key)
- Appendix 3.3A: Chemical Kinetics: Assignment 2
- Appendix 3.3B: Chemical Kinetics: Assignment 2 (Answer Key)
- Appendix 3.4A: Chemical Kinetics Problems
- Appendix 3.4B: Chemical Kinetics Problems (Answer Key)

**Selecting Learning Resources**

For additional information on selecting learning resources for Grade 11 and Grade 12 Chemistry, see the Manitoba Education website at <[www.edu.gov.mb.ca/k12/learnres/bibliographies.html](http://www.edu.gov.mb.ca/k12/learnres/bibliographies.html)>.

**SKILLS AND ATTITUDES OUTCOMES**

**C12-0-S5:** Collect, record, organize, and display data using an appropriate format.

*Examples: labelled diagrams, graphs, multimedia applications, software integration, probeware . . .*

**C12-0-S6:** Estimate and measure accurately using Système International (SI) and other standard units.

Include: SI conversions and significant figures

**C12-0-S7:** Interpret patterns and trends in data, and infer and explain relationships.

---

**NOTES**

**Topic 3:  
Chemical  
Kinetics**
**SPECIFIC LEARNING OUTCOMES**

**C12-3-05:** Perform a laboratory activity to identify factors that affect the rate of a chemical reaction.

Include: nature of reactants, surface area, concentration, pressure, volume, temperature, and presence of a catalyst

**C12-3-06:** Use the collision theory to explain the factors that affect the rate of chemical reactions.

Include: activation energy and orientation of molecules

(2 hours)

SLO: C12-3-05  
SLO: C12-3-06

**SUGGESTIONS FOR INSTRUCTION**
**TEACHER NOTES**

At this point, introduce students to the collision theory of chemical reactions. The *collision theory* states that in order for a chemical reaction to occur, the reacting particles must collide. If the particles do not collide, no reaction occurs. Not all collisions, however, produce a chemical reaction. Reacting particles must collide with **sufficient kinetic energy** (called *activation energy*) and the **correct collision geometry or orientation**.

*Activation energy* ( $E_a$ ) is the minimum amount of kinetic energy required for particles to collide effectively, that is, to produce a chemical reaction.

*Example:*

Orientation of nitrogen monoxide molecule **unlikely** to produce a reaction.

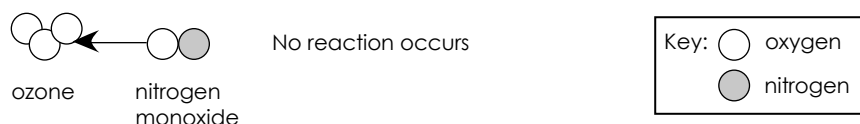

Orientation of nitrogen monoxide molecule **likely** to produce a reaction.

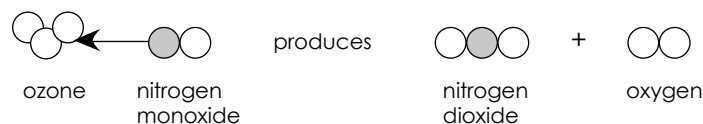
**General Learning Outcome Connections**

**GLO C2:** Demonstrate appropriate scientific skills when seeking answers to questions.

**GLO C5:** Demonstrate curiosity, skepticism, creativity, open-mindedness, accuracy, precision, honesty, and persistence, and appreciate their importance as scientific and technological habits of mind.

**GLO C8:** Evaluate, from a scientific perspective, information and ideas encountered during investigations and in daily life.

**GLO D3:** Understand the properties and structures of matter, as well as various common manifestations and applications of the actions and interactions of matter.

**GLO D4:** Understand how stability, motion, forces, and energy transfers and transformations play a role in a wide range of natural and constructed contexts.



**SKILLS AND ATTITUDES OUTCOMES**

**C12-0-S2:** State a testable hypothesis or prediction based on background data or on observed events.

**C12-0-S7:** Interpret patterns and trends in data, and infer and explain relationships.

**C12-0-S9:** Draw a conclusion based on the analysis and interpretation of data.

Include: cause-and-effect relationships, alternative explanations, and supporting or rejecting a hypothesis or prediction

---

**Animations/Simulations**

Have students view online animations or simulations of chemical reactions.

*Sample Websites:*

Chemical Education Research Group, Iowa State University. "Chemistry Experiment Simulations and Conceptual Computer Animations." *Chemical Education*. <<http://group.chem.iastate.edu/Greenbowe/sections/projectfolder/simDownload/index4.html>> (22 Nov. 2012).

In the Kinetics section, download and unzip the following animation:

■ **NO + O<sub>3</sub> Bimolecular Collision**

This animation shows the correct orientation of molecules upon collision, the reaction being  $O_3 + NO \rightarrow NO_2 + O_2$ . To break apart the ozone molecule (O<sub>3</sub>), the nitrogen atom of the nitrogen monoxide molecule must collide with the correct positioning and sufficient energy to cause the chemical reaction to occur.

University of Colorado at Boulder. "Reactions and Rates." *PhET Interactive Simulations*. <<http://phet.colorado.edu/en/simulation/reactions-and-rates>> (22 Nov. 2012).

This animation allows students to explore the factors that affect reaction rates by changing variables such as concentrations, activation energy, and collision orientation.

**Factors Affecting the Rate of a Chemical Reaction**

Factors affecting the rate of a chemical reaction include the nature of reactants, surface area, concentration, pressure, volume, temperature, and presence of a catalyst. A discussion of these factors follows.

■ **Collision Theory and the Nature of Reactants**

Some chemical reactions involve the rearrangement of atoms as a result of bonds breaking to form new bonds. Other reactions are a result of electron transfer. The nature of the reactants involved in the reaction will affect the rate of reaction. Reactions that involve ionic compounds and simple ions are usually faster than reactions involving molecular compounds. The fewer the number of bonds broken, the faster the reaction rate will be. The weaker the bonds are in the reactants, the faster the reaction will be. The state of the reactants (solid, liquid, or gas) will also affect the rate of reactions.

**Topic 3:  
Chemical  
Kinetics**

**SPECIFIC LEARNING OUTCOMES**

**C12-3-05:** Perform a laboratory activity to identify factors that affect the rate of a chemical reaction.

Include: nature of reactants, surface area, concentration, pressure, volume, temperature, and presence of a catalyst

**C12-3-06:** Use the collision theory to explain the factors that affect the rate of chemical reactions.

Include: activation energy and orientation of molecules

(continued)

■ **Collision Theory and Surface Area**

From the lab activities suggested for learning outcome C12-3-05, students will observe that increasing the surface area of a solid increases the reaction rate. Collisions can occur only at a solid's surface, so a powdered substance, such as calcium carbonate ( $\text{CaCO}_3$ ), will react more quickly than a large crystal of  $\text{CaCO}_3$  as the powdered substance allows more surface area to be in contact with the other reactants.

■ **Collision Theory and Concentration (Pressure, Volume)**

The collision theory states that particles must collide with each other to react. If the concentration of one reactant is increased, the reaction rate should increase, as there are more molecules of the increased reactant that can collide.

- At the particulate level, if one molecule of A reacts with two molecules of B, two collisions are possible, which could result in a reaction.



- If the concentration of A is doubled, four collisions are possible, which could result in a reaction.

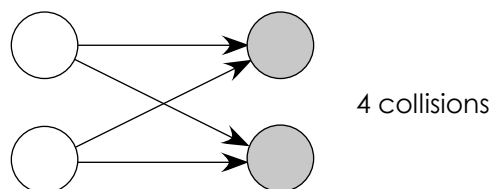

**SKILLS AND ATTITUDES OUTCOMES**

**C12-0-S2:** State a testable hypothesis or prediction based on background data or on observed events.

**C12-0-S7:** Interpret patterns and trends in data, and infer and explain relationships.

**C12-0-S9:** Draw a conclusion based on the analysis and interpretation of data.

Include: cause-and-effect relationships, alternative explanations, and supporting or rejecting a hypothesis or prediction

- If the concentration of A is tripled, six collisions are possible, which could result in a reaction.

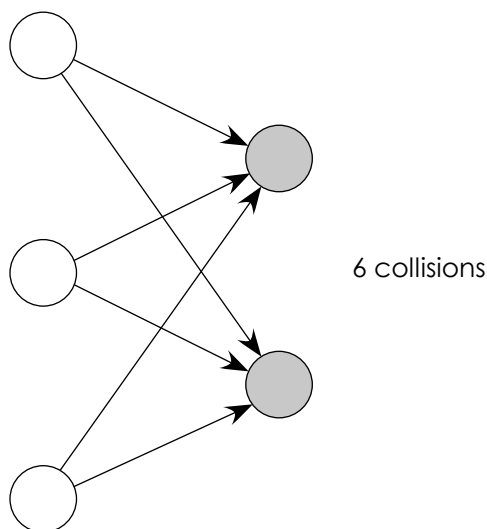

Increasing the frequency by which collisions can occur in terms of increased concentration results in a faster reaction rate.

- **Effective Collisions and Temperature**

The following graph shows two different temperatures and the number of molecules that have sufficient energy to react. The shaded area under both curves indicate that there are more molecules that have sufficient activation energy at  $T_2$  (higher temperature) than at  $T_1$  (lower temperature) (see van Kessel, et al. 383).

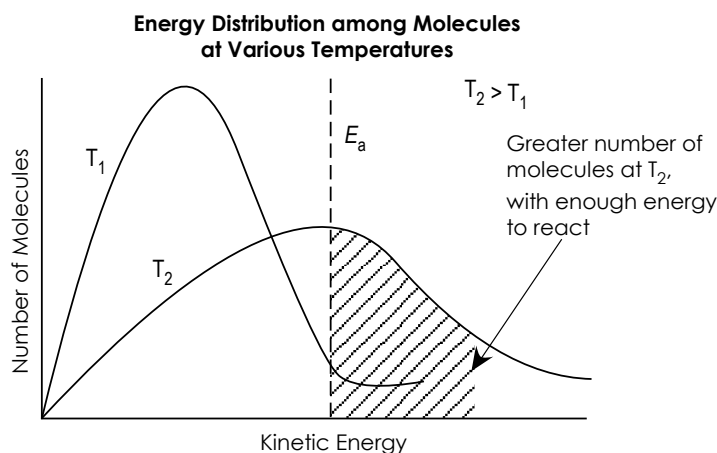

**Topic 3:  
Chemical  
Kinetics**

---

**SPECIFIC LEARNING OUTCOMES**

**C12-3-05:** Perform a laboratory activity to identify factors that affect the rate of a chemical reaction.

Include: nature of reactants, surface area, concentration, pressure, volume, temperature, and presence of a catalyst

**C12-3-06:** Use the collision theory to explain the factors that affect the rate of chemical reactions.

Include: activation energy and orientation of molecules

(continued)

---

**Laboratory Activities**

Have students perform lab activities that will lead them to discover the factors that affect the rate of a reaction, rather than perform a verification lab. Some possible lab activities are suggested below.

From the suggested lab activities, students should conclude that

- increasing temperature will increase the rate of a reaction (decreasing reaction time)
- increasing the concentration of reactant(s) will increase the rate of a reaction (Note that pressure and volume are a subset of concentration.)
- increasing the surface area will increase the rate of a reaction
- the presence of a catalyst will increase the rate of a reaction
- the nature (type) of reactants will affect the rate of a reaction

Choose one or more lab activities appropriate for the class.

- **Factors Affecting the Rate of Reactions** (concentration, temperature). See Appendix 3.5A: Factors Affecting the Rate of Reactions: Lab Activity and Appendix 3.5B: Factors Affecting the Rate of Reactions: Lab Activity (Answer Key).

This is a version of the classic Iodine Clock Reaction lab activity in which excess iodine reacts with starch to produce a blue-black product only when the reaction is complete. In this lab activity, students investigate the effects of concentration and temperature on reaction rate.

In Part A, students change the concentration of one reactant, and time how long it takes for the sudden and dramatic colour change to occur.

In Part B, students investigate the role of temperature in reaction rate by running a series of reactions in water baths at different temperatures.

Students produce graphs of their data, draw conclusions about the relationship between these variables, and explain the differences in reaction rate using the collision theory.

**SKILLS AND ATTITUDES OUTCOMES**

**C12-0-S2:** State a testable hypothesis or prediction based on background data or on observed events.

**C12-0-S7:** Interpret patterns and trends in data, and infer and explain relationships.

**C12-0-S9:** Draw a conclusion based on the analysis and interpretation of data.

Include: cause-and-effect relationships, alternative explanations, and supporting or rejecting a hypothesis or prediction

---

- **Factors Affecting the Rate of a Reaction** (concentration, nature of reactants, temperature, catalyst, surface area). See Appendix 3.6A: Factors Affecting the Rate of a Reaction: Lab Activity. Teacher notes are provided in Appendix 3.6B.

In Part A of this lab activity, students study the effect of the nature of reactants on reaction time. Several different metals are reacted with hydrochloric acid, and observations are made with regards to reaction time. Students also study the effect of different solutions reacting with magnesium metal on reaction time.

In Part B, students examine the effect of surface area on reaction time. Mossy zinc and powdered zinc are combined with hydrochloric acid, and the reaction times are recorded. Chips of calcium carbonate and powdered calcium carbonate are reacted with hydrochloric acid, and the reaction times are recorded.

In Part C, students study the effect of temperature on a chemical reaction. A solution of potassium permanganate is combined with oxalic acid, and the reaction time is recorded. A second test tube containing just the potassium permanganate is heated in a hot water bath. Then the oxalic acid is added to the test tube in the hot water bath, and the resulting reaction time is recorded.

Students then set up three test tubes containing hydrochloric acid. One test tube is placed in cold water, the second test tube is kept at room temperature, and the third test tube is placed in a hot water bath. Three identical pieces of magnesium are added to each of the three test tubes, and the resulting reaction times are noted.

In Part D, students use a catalyst to study its effect on reaction time. Potassium permanganate is placed in two test tubes. In one of the test tubes, manganese(II) sulphate is added (catalyst). Then oxalic acid is added to both test tubes, and the reaction times are noted.

**Topic 3:  
Chemical  
Kinetics****SPECIFIC LEARNING OUTCOMES**

**C12-3-05:** Perform a laboratory activity to identify factors that affect the rate of a chemical reaction.

Include: nature of reactants, surface area, concentration, pressure, volume, temperature, and presence of a catalyst

**C12-3-06:** Use the collision theory to explain the factors that affect the rate of chemical reactions.

Include: activation energy and orientation of molecules

(continued)

- **Experiment 23: Factors Affecting the Rate of a Chemical Reaction** (Waterman and Thompson, *Prentice Hall Chemistry: Small-Scale Chemistry Laboratory Manual* 197)

In this four-part lab activity, students study the effects of temperature, surface area, and concentration on the rate of a chemical reaction.

- Students begin by exploring the rate of reaction between hydrochloric acid and magnesium, calcium carbonate, and sodium hydrogen carbonate.
  - They then study the effect of temperature, using the same reactants that were used initially. Cold hydrochloric acid and warm hydrochloric acid are separately reacted with magnesium, calcium carbonate, and sodium hydrogen carbonate.
  - Students continue by investigating the effect of surface area on reaction rate. Hydrochloric acid is reacted with a piece of magnesium, crushed magnesium, a piece of calcium carbonate, and crushed calcium carbonate.
  - Finally, students look at the effect of concentration on reaction rate. Various concentrations of hydrochloric acid are separately reacted with magnesium, calcium carbonate, and sodium hydrogen carbonate.
- **Experiment 36: Factors Affecting Reaction Rates** (Wilbraham, Staley, and Matta, *Prentice Hall Chemistry: Laboratory Manual* 225)

In this experiment, students investigate factors that can speed up or slow down chemical reactions. They examine the effect of temperature, reactant concentration, particle size, catalysts, and surface area on reaction rate.

- **Chemlab 17: Concentration and Reaction Rate** (Dingrando, et al., *Glencoe Chemistry: Matter and Change* 550)

In this lab activity, students investigate the effect of concentration on reaction rate. Pieces of magnesium ribbon are reacted separately with varying concentrations of hydrochloric acid, and the resulting reaction time is recorded.

- **MiniLAB 17: Examining Reaction Rate and Temperature** (Dingrando, et al., *Glencoe Chemistry: Matter and Change* 539)

In this lab activity, students observe the effect of temperature on reaction rate. They dissolve antacid tablets in water at room temperature, at 50°C, and at 65°C.

**SKILLS AND ATTITUDES OUTCOMES**

**C12-0-S2:** State a testable hypothesis or prediction based on background data or on observed events.

**C12-0-S7:** Interpret patterns and trends in data, and infer and explain relationships.

**C12-0-S9:** Draw a conclusion based on the analysis and interpretation of data.

Include: cause-and-effect relationships, alternative explanations, and supporting or rejecting a hypothesis or prediction

- **Investigation 12–A: Factors Affecting the Rate of a Reaction** (Mustoe, et al., *McGraw-Hill Ryerson Chemistry* 464)

In this three-part investigation, students predict and observe the effects of changes to concentration, temperature, reactant, and surface area on the rate of a chemical reaction. In each part, students record the time taken to collect test tubes full of carbon dioxide and calculate the average rate in mL/s.

- Part 1 investigates the effect of concentration on a reaction. Sodium hydrogen carbonate ( $\text{NaHCO}_3$ ) and varying concentrations of vinegar are reacted in four trials.
- Part 2 demonstrates the effect of temperature on reaction rate. Using the same reactants as in Part 1, students perform two trials. Before the reactants are combined, they are first cooled to about  $10^\circ\text{C}$  below room temperature, and then heated to  $10^\circ\text{C}$  above room temperature.
- Part 3 shows the effect of reactants and surface area on reaction rate. Students perform two trials, first combining powdered calcium carbonate ( $\text{CaCO}_3$ ) with vinegar, and then combining solid  $\text{CaCO}_3$  with vinegar.

In their investigations, students should comment on the effects of each factor on reaction rate. If students have not observed factors, provide them with demonstrations to illustrate the factors. In the post-lab discussion, have students explain their observations based on the collision theory.

**Laboratory Demonstrations**

Teachers can choose to demonstrate lab activities such as the following:

- **Experiment 20: A Study of Reaction Rates: The “Clock Reaction”** (Merrill, Parry, and Tellefsen, *Chemistry: Experimental Foundations, Laboratory Manual* 62)

In this two-part experiment, demonstrate the role of concentration and temperature changes on reaction rate.

- **Surface Area and Reaction Rate**

The purpose of this demonstration is to have students observe the effect of an increase in surface area on the rate of a chemical reaction. Place 2 g of lycopodium powder (or starch) in a pile on a porcelain tile. Try to ignite the pile with a burner or lighter. There will be no reaction. Lift the ceramic tile holding the lycopodium powder (or starch) and sprinkle the powder over a lit burner. The powder will ignite quite explosively. Students should observe that the reaction rate increases as surface area increases (Smoot, Price, and Smith 442).

### Topic 3: Chemical Kinetics

#### SPECIFIC LEARNING OUTCOMES

**C12-3-05:** Perform a laboratory activity to identify factors that affect the rate of a chemical reaction.

Include: nature of reactants, surface area, concentration, pressure, volume, temperature, and presence of a catalyst

**C12-3-06:** Use the collision theory to explain the factors that affect the rate of chemical reactions.

Include: activation energy and orientation of molecules

(continued)

#### ■ Catalyst and Reaction Rate

In this demonstration, have students observe the effect of a catalyst on the rate of a chemical reaction. Dissolve 25 g of sodium potassium tartrate (Rochelle's salt) in 300 mL of water in a large beaker. Add 100 mL of 3% to 6% hydrogen peroxide ( $\text{H}_2\text{O}_2$ ) to the beaker. Heat the solution to  $70^\circ\text{C}$ . Students should observe that no reaction occurs. Add the catalyst, cobalt chloride, to the beaker. The solution will turn pink and then a greenish colour (cobalt[II] tartrate complex). After the reaction has been completed, the pink colour in the solution will reappear. The cobalt chloride was not consumed in the reaction. Students should observe that the solution at  $70^\circ\text{C}$  did not chemically react until the catalyst was added (Smoot, Price, and Smith 444).

#### Animations/Simulations

Use a variety of online simulations and video clips, such as the following, to demonstrate how various factors affect the rate of chemical reactions.

Chemical Education Research Group, Iowa State University. "Chemistry Experiment Simulations and Conceptual Computer Animations." *Chemical Education*. <<http://group.chem.iastate.edu/Greenbowe/sections/projectfolder/simDownload/index4.html>> (22 Nov. 2012).

In the Kinetics section, download and unzip the following simulation:

- Arrhenius Equation: Temperature, Rate Constant, and Activation Energy Experiment

In this simulation, students can vary the concentration of reactants and the temperature. Students must start the time clock and wait for the reaction to reach completion (blue-black colour).

The North Carolina School of Science and Mathematics (NCSSM). "Chapter 15: Kinetics." *Chemistry Online Resource Essentials (CORE)*. <[www.dlt.ncssm.edu/core/c15.htm](http://www.dlt.ncssm.edu/core/c15.htm)> (9 Feb. 2012).

The following video clips are available on this website:

- *Homogeneous Catalyst* shows how the presence of a catalyst affects reaction rate. Specifically, it shows the decomposition of hydrogen peroxide ( $\text{H}_2\text{O}_2$ ), using a solution of  $\text{Co}^{2+}$ .



**SKILLS AND ATTITUDES OUTCOMES**

**C12-0-S2:** State a testable hypothesis or prediction based on background data or on observed events.

**C12-0-S7:** Interpret patterns and trends in data, and infer and explain relationships.

**C12-0-S9:** Draw a conclusion based on the analysis and interpretation of data.

Include: cause-and-effect relationships, alternative explanations, and supporting or rejecting a hypothesis or prediction

- *KI Catalyzed H<sub>2</sub>O<sub>2</sub> Decomposition* shows how the addition of a catalyst affects reaction rate. Specifically, it shows the decomposition of H<sub>2</sub>O<sub>2</sub>, catalyzed with manganese dioxide (MnO<sub>2</sub>) and uncatalyzed.
- *Glow Sticks* shows how temperature affects reaction rate. One Glow Stick is placed in hot water and another is placed in cold water.
- *Potato Catalyzed H<sub>2</sub>O<sub>2</sub> Decomposition* shows how surface area affects reaction rate. Small pieces of potato are placed in a test tube containing H<sub>2</sub>O<sub>2</sub>. A small amount of detergent is placed in each test tube to make the bubbles of oxygen more visible.
- *Dust Explosion* shows the effect of surface area on reaction rate. The video clip shows the explosive nature of flour when placed in a closed container and then ignited with a candle.

Petrucci, Ralph H., William S. Harwood, and Geoffrey Herring. "Chapter 15: Chemical Kinetics." *General Chemistry: Principles and Modern Applications*. 8th ed. Prentice Hall, Inc.  
<[http://cwx.prenhall.com/petrucci/medialib/media\\_portfolio/15.html](http://cwx.prenhall.com/petrucci/medialib/media_portfolio/15.html)>  
(8 May 2012).

The following simulation is available on this website (in the Instructor's Media Portfolio of Prentice Hall's *Companion Website for General Chemistry*):

- *CFCs and Stratospheric Ozone* shows the catalytic decomposition of ozone by chlorine atoms from CFCs.

University of Colorado at Boulder. "Reactions and Rates." *PhET Interactive Simulations*. <<http://phet.colorado.edu/en/simulation/reactions-and-rates>>  
(22 Nov. 2012).

**SUGGESTIONS FOR ASSESSMENT****Paper-and-Pencil Tasks**

1. Have students compare and contrast the rate at which a sugar cube dissolves in cold water and the rate at which granulated sugar dissolves in warm water. Students could include observations of how surface area and water temperature might affect the rate at which each substance dissolves (Fisher 238).
2. Have students describe how the collision theory would apply to a demolition derby (Fisher 236).

### Topic 3: Chemical Kinetics

#### SPECIFIC LEARNING OUTCOMES

**C12-3-05:** Perform a laboratory activity to identify factors that affect the rate of a chemical reaction.

Include: nature of reactants, surface area, concentration, pressure, volume, temperature, and presence of a catalyst

**C12-3-06:** Use the collision theory to explain the factors that affect the rate of chemical reactions.

Include: activation energy and orientation of molecules

(continued)

#### Visual Displays

Students can represent a reaction between two substances, such as nitrogen monoxide (NO) and ozone (O<sub>3</sub>), using ball-and-stick molecular models. Students can show the correct orientation of the molecules as they collide to produce nitrogen dioxide (NO<sub>2</sub>) and oxygen (O<sub>2</sub>). They can also show the incorrect orientation of the molecules that would not produce a reaction.

#### Laboratory Report

The lab activities could be assessed by having students use the Laboratory Report Outline or complete a Laboratory Report Frame (SYSTH 11.38, 14.12). Also refer to the Lab Report Assessment rubric in Appendix 11.

#### Laboratory Skills

Periodically and randomly review students' lab skills using a variety of rubrics and checklists (see SYSTH 6.10, 6.11).

#### Research and Reports

Students could research and report on how the rate of specific chemical processes can be controlled. As an alternative to preparing a report, students could complete an Article Analysis Frame on a related article (SYSTH 11.30, 11.40, 11.41).

#### LEARNING RESOURCES LINKS



*Chemistry* (Chang 554, 566)

*Chemistry* (Zumdahl and Zumdahl 587)

*Chemistry: The Molecular Nature of Matter and Change* (Silberberg 674, 694, 706)

*Glencoe Chemistry: Matter and Change* (Dingrando, et al. 532, 536)

*Glencoe Chemistry: Matter and Change, Science Notebook* (Fisher 236, 238)

*McGraw-Hill Ryerson Chemistry, Combined Atlantic Edition* (Mustoe, et al. 464, 470)

*McGraw-Hill Ryerson Inquiry into Chemistry* (Chastko, et al. 404)

*Merrill Chemistry: A Modern Course* (Smoot, Price, and Smith 442)

*Nelson Chemistry 12, Ontario Edition* (van Kessel, et al. 367, 383)

*Prentice Hall Chemistry* (Wilbraham, et al. 541, 545)

**SKILLS AND ATTITUDES OUTCOMES**

**C12-0-S2:** State a testable hypothesis or prediction based on background data or on observed events.

**C12-0-S7:** Interpret patterns and trends in data, and infer and explain relationships.

**C12-0-S9:** Draw a conclusion based on the analysis and interpretation of data.

Include: cause-and-effect relationships, alternative explanations, and supporting or rejecting a hypothesis or prediction

**Investigations**

*Chemistry: Experimental Foundations, Laboratory Manual* (Merrill, Parry, and Tellefsen)

Experiment 20: A Study of Reaction Rates: The “Clock Reaction,” 62

*Glencoe Chemistry: Matter and Change* (Dingrando, et al.)

Chemlab 17: Concentration and Reaction Rate, 550

MiniLAB 17: Examining Reaction Rate and Temperature, 539

*McGraw-Hill Ryerson Chemistry, Combined Atlantic Edition* (Mustoe, et al.).

Investigation 12–A: Factors Affecting the Rate of a Reaction, 464

*Prentice Hall Chemistry: Laboratory Manual* (Wilbraham, Staley, and Matta)

Factors Affecting Reaction Rates, 225

(temperature, reactant concentration, particle size, catalysis, and surface area)

*Prentice Hall Chemistry: Small-Scale Chemistry Laboratory Manual* (Waterman and Thompson)

Experiment 28: Factors Affecting the Rate of a Chemical Reaction, 197

(temperature, concentration, and surface area)

**Websites**

Chemical Education Research Group, Iowa State University. “Chemistry Experiment Simulations and Conceptual Computer Animations.” *Chemical Education*. <<http://group.chem.iastate.edu/Greenbowe/sections/projectfolder/simDownload/index4.html>> (22 Nov. 2012).

Simulation: Arrhenius Equation: Temperature, Rate Constant, and Activation Energy Experiment

Animation: NO + O<sub>3</sub> Bimolecular Collision

The North Carolina School of Science and Mathematics (NCSSM). “

Chapter 15: Kinetics.” *Chemistry Online Resource Essentials (CORE)*.

<[www.dlt.ncssm.edu/core/c15.htm](http://www.dlt.ncssm.edu/core/c15.htm)> (9 Feb. 2012).

Petrucci, Ralph H., William S. Harwood, and Geoffrey Herring. “Chapter 15: Chemical Kinetics.” *General Chemistry: Principles and Modern Applications*. 8th ed. Prentice Hall, Inc.

<[http://cwx.prenhall.com/petrucci/medialib/media\\_portfolio/15.html](http://cwx.prenhall.com/petrucci/medialib/media_portfolio/15.html)> (8 May 2012).

University of Colorado at Boulder. “Reactions and Rates.” *PhET Interactive Simulations*. <<http://phet.colorado.edu/en/simulation/reactions-and-rates>> (22 Nov. 2012).

**Topic 3:  
Chemical  
Kinetics**

---

**SPECIFIC LEARNING OUTCOMES**

**C12-3-05:** Perform a laboratory activity to identify factors that affect the rate of a chemical reaction.

Include: nature of reactants, surface area, concentration, pressure, volume, temperature, and presence of a catalyst

**C12-3-06:** Use the collision theory to explain the factors that affect the rate of chemical reactions.

Include: activation energy and orientation of molecules

*(continued)*

---

**Appendices**

Appendix 3.5A: Factors Affecting the Rate of Reactions: Lab Activity

Appendix 3.5B: Factors Affecting the Rate of Reactions: Lab Activity  
(Answer Key)

Appendix 3.6A: Factors Affecting the Rate of a Reaction: Lab Activity

Appendix 3.6B: Factors Affecting the Rate of a Reaction: Lab Activity  
(Teacher Notes)

**Selecting Learning Resources**

For additional information on selecting learning resources for Grade 11 and Grade 12 Chemistry, see the Manitoba Education website at <[www.edu.gov.mb.ca/k12/learnres/bibliographies.html](http://www.edu.gov.mb.ca/k12/learnres/bibliographies.html)>.

**SKILLS AND ATTITUDES OUTCOMES**

**C12-0-S2:** State a testable hypothesis or prediction based on background data or on observed events.

**C12-0-S7:** Interpret patterns and trends in data, and infer and explain relationships.

**C12-0-S9:** Draw a conclusion based on the analysis and interpretation of data.

Include: cause-and-effect relationships, alternative explanations, and supporting or rejecting a hypothesis or prediction

---

**NOTES**

### Topic 3: Chemical Kinetics

#### SPECIFIC LEARNING OUTCOMES

**C12-3-07:** Draw potential energy diagrams for endothermic and exothermic reactions.

Include: relative rates, effects of catalyst, and heat of reaction (enthalpy change)

**C12-3-08:** Describe qualitatively the relationship between the factors that affect the rate of chemical reactions and the relative rate of a reaction, using the collision theory.

(2 hours)

SLO: C12-3-07  
SLO: C12-3-08

#### SUGGESTIONS FOR INSTRUCTION

##### Entry-Level Knowledge

In Grade 10 Science (S2-3-09), students learned about kinetic and potential energy with respect to motion. In Grade 11 Chemistry (C11-1-02), students were introduced to the kinetic molecular theory to explain the properties of gases.

##### TEACHER NOTES

An *exothermic reaction* is a chemical reaction that releases energy into the environment. Combustion, or burning, is an example of an exothermic reaction. On the other hand, an *endothermic reaction* is a chemical reaction that absorbs energy from its surroundings, which is stored in the products that have formed. For example, if aluminum chloride is dissolved in water, the beaker will feel cool to the touch.

Students are expected to draw potential energy diagrams indicating the amount of potential energy the reactants and the products have, the activation energy ( $E_a$ ) needed, the activated complex, and the change in enthalpy ( $\Delta H$ ) or the heat of reaction—that is, how much heat is absorbed (endothermic reaction) or how much heat is released (exothermic reaction).

The activation energy of a reaction dictates the relative rate of a reaction. The higher the activation energy is, the slower the reaction rate is, and vice versa. Catalysts increase reaction rates by reducing the activation energy. Catalysts do not affect the heat of reaction.

##### Demonstration

For the kinesthetic learner, demonstrate the following:

1. Roll a ball up an incline and let the ball roll back down. The ball represents the reactants that do not have enough activation energy to reach the activated complex.

#### General Learning Outcome Connections

**GLO D3:** Understand the properties and structures of matter, as well as various common manifestations and applications of the actions and interactions of matter.

## SKILLS AND ATTITUDES OUTCOMES

**C12-0-U1:** Use appropriate strategies and skills to develop an understanding of chemical concepts.

*Examples: analogies, concept frames, concept maps, manipulatives, particulate representations, role-plays, simulations, sort-and-predict frames, word cycles . . .*

**C12-0-U2:** Demonstrate an understanding of chemical concepts.

*Examples: use accurate scientific vocabulary, explain concepts to others, compare and contrast concepts, apply knowledge to new situations and/or contexts, create analogies, use manipulatives . . .*

- Roll a ball up a shallower incline and allow the ball to roll over the edge of the incline. The shallower incline represents the addition of a catalyst, which lowers activation energy and allows the reaction to proceed (Dingrando, et al, *Glencoe Chemistry: Matter and Change, Teacher Wraparound Edition* 540).

## Potential Energy Diagrams

Students can use the collision theory and kinetic energy and potential energy diagrams to explain their observations from the lab investigations performed in relation to specific learning outcome C12-3-02. Students' explanations should include observations of what is happening at the **molecular** level.

The following diagram shows the progress of an *endothermic reaction*.

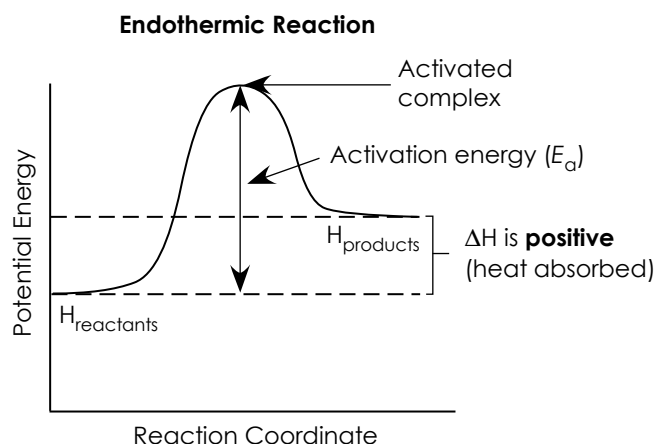

In this diagram, the reactants contain a certain amount of potential energy. As the reaction proceeds from left to right, the molecules of the reactants gain more energy, which is called *activation energy*. If the reactants have sufficient energy to reach the activated complex, then bond breakage and realignment can occur and new substances are formed. The products that have formed have a greater amount of potential energy than the reactants had. This means that energy was absorbed during the chemical reaction from its surroundings. If this reaction had taken place in a beaker, the beaker would have felt cool to the touch. The heat of reaction, or enthalpy change, is a positive value because the potential energy of the products is larger than the potential energy of the reactants.

$$\Delta H = H_{\text{products}} - H_{\text{reactants}} = \text{positive value} = \text{heat is absorbed}$$

### Topic 3: Chemical Kinetics

#### SPECIFIC LEARNING OUTCOMES

**C12-3-07:** Draw potential energy diagrams for endothermic and exothermic reactions.

Include: relative rates, effects of catalyst, and heat of reaction (enthalpy change)

**C12-3-08:** Describe qualitatively the relationship between the factors that affect the rate of chemical reactions and the relative rate of a reaction, using the collision theory.

(continued)

The following diagram shows the progress of an *exothermic reaction*.

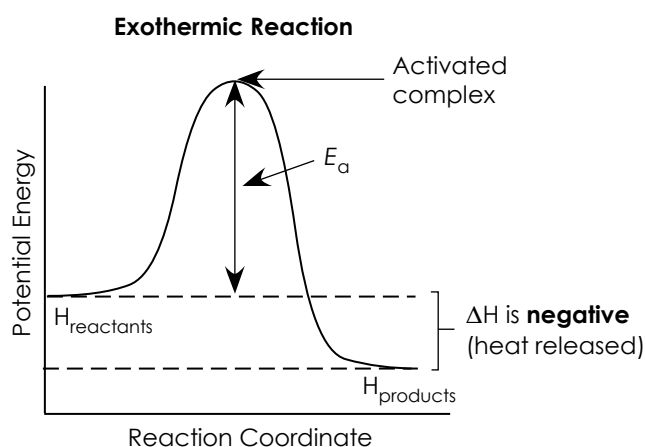

In this diagram, the reactants contain a certain amount of potential energy. As the reaction proceeds from left to right, the molecules of the reactants gain more energy, which is called activation energy. If the reactants have sufficient energy to reach the activated complex, then bond breakage and realignment can occur and new substances are formed. The products that have formed have a lower amount of potential energy than the reactants had. This means that energy was released during the chemical reaction to its surroundings. If this reaction had taken place in a beaker, the beaker would have felt warm to the touch.

$$\Delta H = H_{\text{products}} - H_{\text{reactants}} = \text{negative value} = \text{heat is released}$$



**SKILLS AND ATTITUDES OUTCOMES**

**C12-0-U1:** Use appropriate strategies and skills to develop an understanding of chemical concepts.

*Examples: analogies, concept frames, concept maps, manipulatives, particulate representations, role-plays, simulations, sort-and-predict frames, word cycles . . .*

**C12-0-U2:** Demonstrate an understanding of chemical concepts.

*Examples: use accurate scientific vocabulary, explain concepts to others, compare and contrast concepts, apply knowledge to new situations and/or contexts, create analogies, use manipulatives . . .*

The following potential energy diagram indicates the reaction  
 $\text{CH}_3\text{CH}_2\text{Br} + \text{OH}^- \rightarrow \text{CH}_3\text{CH}_2\text{OH} + \text{Br}^-$ .

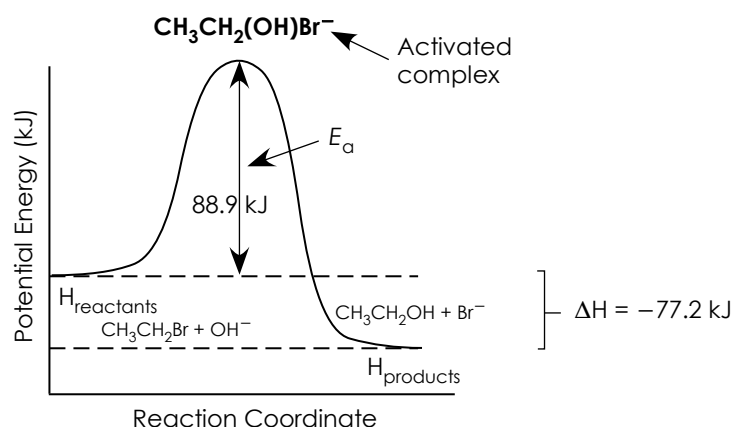

Students should be able to indicate on the potential energy diagram the potential energy of the reactants, the potential energy of the products, the activation energy, the location of the activated complex, and the heat of reaction, or enthalpy change.

The following potential energy diagram for the reaction  $2\text{BrNO} \rightarrow 2\text{NO} + \text{Br}_2$  shows the transition state where the molecules of nitrogen, bromine, and oxygen are rearranged to form the products.

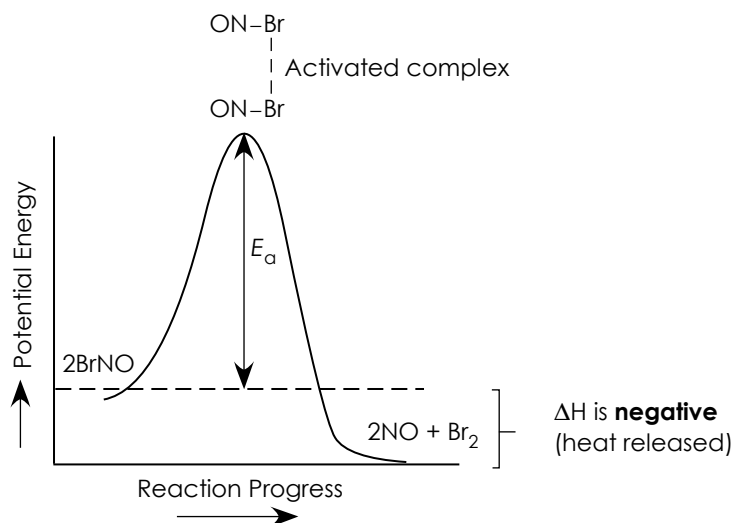

### Topic 3: Chemical Kinetics

#### SPECIFIC LEARNING OUTCOMES

**C12-3-07:** Draw potential energy diagrams for endothermic and exothermic reactions.

Include: relative rates, effects of catalyst, and heat of reaction (enthalpy change)

**C12-3-08:** Describe qualitatively the relationship between the factors that affect the rate of chemical reactions and the relative rate of a reaction, using the collision theory.

(continued)

At the particulate level, this is how the potential energy diagram would appear for the chemical reaction just described (Zumdahl and Zumdahl 588):

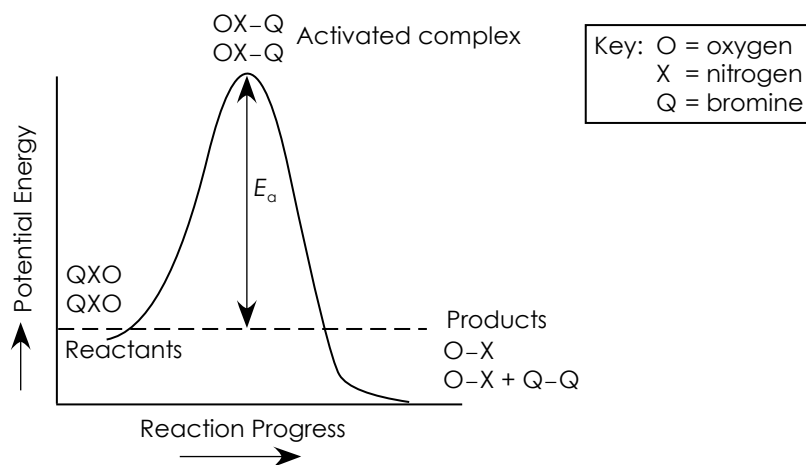

#### Relative Rates

Teachers may wish to use potential energy diagrams to describe whether a reaction is slow, medium, or fast.

#### Relative Rates of Reaction

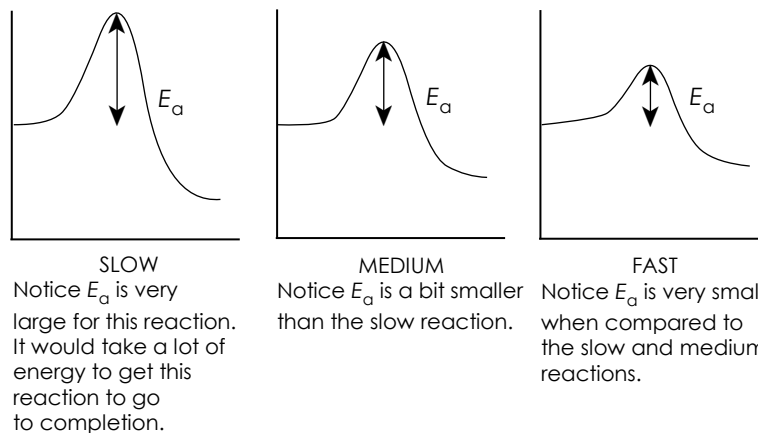

**SKILLS AND ATTITUDES OUTCOMES**

**C12-0-U1:** Use appropriate strategies and skills to develop an understanding of chemical concepts.

*Examples: analogies, concept frames, concept maps, manipulatives, particulate representations, role-plays, simulations, sort-and-predict frames, word cycles . . .*

**C12-0-U2:** Demonstrate an understanding of chemical concepts.

*Examples: use accurate scientific vocabulary, explain concepts to others, compare and contrast concepts, apply knowledge to new situations and/or contexts, create analogies, use manipulatives . . .*

**Catalyst Added in a Reaction**

The following potential energy diagram shows an uncatalyzed reaction and a catalyzed reaction.

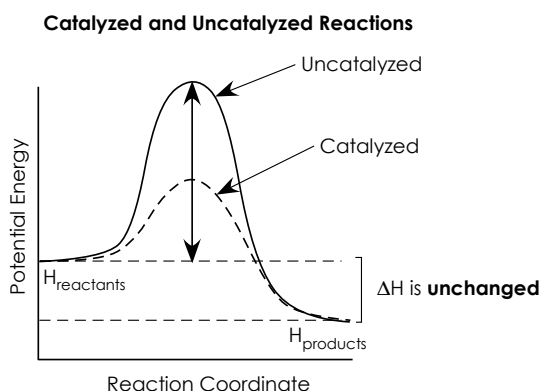

Students should have concluded from their lab activities (in relation to learning outcome C12-3-05) that when a catalyst is added to a chemical reaction the reaction rate increases (the reaction time is shorter). Students should note that the diagram indicating the presence of a catalyst shows that a smaller activation energy is required. They should note that the heat of reaction, or enthalpy change, does not change.

In Diagram A below, the catalyst makes it possible for more particles to have sufficient kinetic energy to reach the activated complex. The activation energy is lowered, meaning that more particles are available to collide and form new product. Diagram B shows that the activation energy is lowered, enabling more collisions to occur. This results in more product being formed.

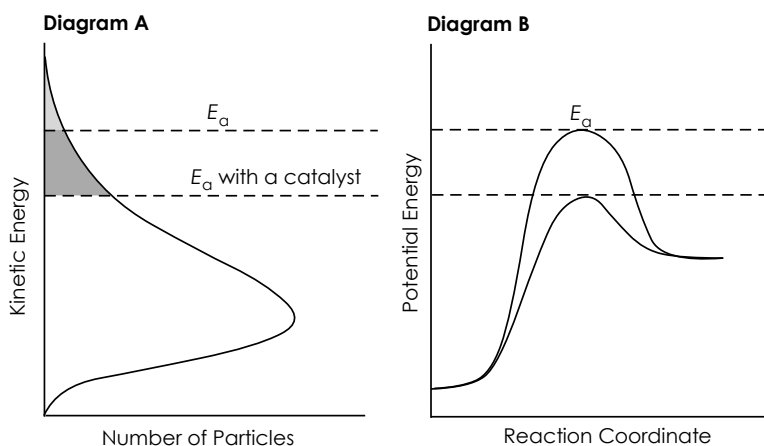

**Topic 3:  
Chemical  
Kinetics**

---

**SPECIFIC LEARNING OUTCOMES**

**C12-3-07:** Draw potential energy diagrams for endothermic and exothermic reactions.

Include: relative rates, effects of catalyst, and heat of reaction (enthalpy change)

**C12-3-08:** Describe qualitatively the relationship between the factors that affect the rate of chemical reactions and the relative rate of a reaction, using the collision theory.

(continued)

---

**Collision Theory and Factors Affecting Rate of Reactions**

In addressing learning outcomes C12-3-07 and C12-3-08, see the learning activities suggested for learning outcomes C12-3-05 and C12-3-06.

**Demonstrations/Animations**

A variety of demonstrations/animations can be viewed online to reinforce the effects of factors affecting the rate of chemical reactions.

*Sample Websites:*

The North Carolina School of Science and Mathematics (NCSSM). "Chapter 15: Kinetics." *Chemistry Online Resource Essentials (CORE)*. <[www.dlt.ncssm.edu/core/c15.htm](http://www.dlt.ncssm.edu/core/c15.htm)> (9 Feb. 2012).

The following video clips, available on this website, can help students describe the factors affecting chemical reaction rates.

- *KI Catalyzed H<sub>2</sub>O<sub>2</sub> Decomposition* shows how the addition of a catalyst affects reaction rate. Specifically, it shows the decomposition of H<sub>2</sub>O<sub>2</sub>, catalyzed with manganese dioxide (MnO<sub>2</sub>) and uncatalyzed.
- *Glow Sticks* shows how temperature affects reaction rate. One Glow Stick is placed in hot water and another is placed in cold water.
- *Potato Catalyzed H<sub>2</sub>O<sub>2</sub> Decomposition* shows how surface area affects reaction rate. Small pieces of potato are placed in a test tube containing H<sub>2</sub>O<sub>2</sub>. A small amount of detergent is placed in each test tube to make the bubbles of oxygen more visible.
- *Dust Explosion* shows the effect of surface area on reaction rate. The video clip shows the explosive nature of flour when placed in a closed container and then ignited with a candle.

**SKILLS AND ATTITUDES OUTCOMES**

**C12-0-U1:** Use appropriate strategies and skills to develop an understanding of chemical concepts.

*Examples: analogies, concept frames, concept maps, manipulatives, particulate representations, role-plays, simulations, sort-and-predict frames, word cycles . . .*

**C12-0-U2:** Demonstrate an understanding of chemical concepts.

*Examples: use accurate scientific vocabulary, explain concepts to others, compare and contrast concepts, apply knowledge to new situations and/or contexts, create analogies, use manipulatives . . .*

———. Distance Education and Extended Programs. “Chemistry – Kinetics.” *Teacher’s Instructional Graphics and Educational Resource (TIGER)*.  
<[www.dlt.ncssm.edu/tiger/chem5.htm#kinetics](http://www.dlt.ncssm.edu/tiger/chem5.htm#kinetics)> (10 Feb. 2012).

The following animations are available on this website:

- *Molecular\_collision\_E<sub>a</sub>* (.exe or .html) demonstrates the change in potential energy for two molecules as they collide. Low energy and high energy simulations are shown.
- *Catalys\_2* (.exe or .html) shows the solid state catalytic hydrogenation of an alkene.

Petrucci, Ralph H., William S. Harwood, and Geoffrey Herring. “Chapter 15: Chemical Kinetics.” *General Chemistry: Principles and Modern Applications*. 8th ed. Prentice Hall, Inc.

<[http://cwx.prenhall.com/petrucci/medialib/media\\_portfolio/15.html](http://cwx.prenhall.com/petrucci/medialib/media_portfolio/15.html)> (8 May 2012).

The following simulation is available on this website (in the Instructor’s Media Portfolio of Prentice Hall’s *Companion Website for General Chemistry*):

- *CFCs and Stratospheric Ozone* shows the catalytic decomposition of ozone by chlorine atoms from CFCs.

Science Bob. “Crazy Foam Experiment.” *Science Bob Videos*.

<[www.sciencebob.com/experiments/videos/video-foam1.php](http://www.sciencebob.com/experiments/videos/video-foam1.php)> (13 Jan. 2012).

This experiment shows how the presence of a catalyst affects reaction rate.

**SUGGESTIONS FOR ASSESSMENT****Paper-and-Pencil Tasks**

Students should be able to interpret and draw potential energy diagrams from given information.

**Journal Writing**

Students can interpret graphs by answering the following questions:

- Are the reactants or the products at a higher energy level?
- Is energy absorbed or released after the reaction takes place?
- Will the reaction always proceed to form products once the activated complex is formed? Explain.

**Topic 3:  
Chemical  
Kinetics**

**SPECIFIC LEARNING OUTCOMES**

- C12-3-07:** Draw potential energy diagrams for endothermic and exothermic reactions.  
Include: relative rates, effects of catalyst, and heat of reaction (enthalpy change)
- C12-3-08:** Describe qualitatively the relationship between the factors that affect the rate of chemical reactions and the relative rate of a reaction, using the collision theory.

(continued)

**LEARNING RESOURCES LINKS**



*Chemistry* (Chang 566)

*Chemistry* (Zumdahl and Zumdahl 588)

*Chemistry: The Molecular Nature of Matter and Change* (Silberberg 696, 698)

*Glencoe Chemistry: Concepts and Applications* (Phillips, Strozak, and Wistrom 713)

*Glencoe Chemistry: Matter and Change* (Dingrando, et al. 534, 540)

*Glencoe Chemistry: Matter and Change, Teacher Wraparound Edition* (Dingrando, et al. 540)

*McGraw-Hill Ryerson Chemistry, Combined Atlantic Edition* (Mustoe, et al. 472)

*McGraw-Hill Ryerson Inquiry into Chemistry* (Chastko, et al. 404)

*Nelson Chemistry 12, Ontario Edition* (van Kessel, et al. 384, 392)

*Prentice Hall Chemistry* (Wilbraham, et al. 543)

**Websites**

The North Carolina School of Science and Mathematics (NCSSM).

“Chapter 15: Kinetics.” *Chemistry Online Resource Essentials (CORE)*.  
<[www.dlt.ncssm.edu/core/c15.htm](http://www.dlt.ncssm.edu/core/c15.htm)> (9 Feb. 2012).

\_\_\_\_\_. Distance Education and Extended Programs. “Chemistry – Kinetics.”  
*Teacher’s Instructional Graphics and Educational Resource (TIGER)*.  
<[www.dlt.ncssm.edu/tiger/chem5.htm#kinetics](http://www.dlt.ncssm.edu/tiger/chem5.htm#kinetics)> (10 Feb. 2012).

Petrucci, Ralph H., William S. Harwood, and Geoffrey Herring. “Chapter 15: Chemical Kinetics.” *General Chemistry: Principles and Modern Applications*. 8th ed. Prentice Hall, Inc.  
<[http://cwx.prenhall.com/petrucci/medialib/media\\_portfolio/15.html](http://cwx.prenhall.com/petrucci/medialib/media_portfolio/15.html)> (8 May 2012).

Science Bob. “Crazy Foam Experiment.” *Science Bob Videos*.  
<[www.sciencebob.com/experiments/videos/video-foam1.php](http://www.sciencebob.com/experiments/videos/video-foam1.php)> (13 Jan. 2012).

**Selecting Learning Resources**

For additional information on selecting learning resources for Grade 11 and Grade 12 Chemistry, see the Manitoba Education website at <[www.edu.gov.mb.ca/k12/learnres/bibliographies.html](http://www.edu.gov.mb.ca/k12/learnres/bibliographies.html)>.

**SKILLS AND ATTITUDES OUTCOMES**

**C12-0-U1:** Use appropriate strategies and skills to develop an understanding of chemical concepts.

*Examples: analogies, concept frames, concept maps, manipulatives, particulate representations, role-plays, simulations, sort-and-predict frames, word cycles . . .*

**C12-0-U2:** Demonstrate an understanding of chemical concepts.

*Examples: use accurate scientific vocabulary, explain concepts to others, compare and contrast concepts, apply knowledge to new situations and/or contexts, create analogies, use manipulatives . . .*

---

**NOTES**

**Topic 3:  
Chemical  
Kinetics**

**SPECIFIC LEARNING OUTCOME**

**C12-3-09:** Explain the concept of a reaction mechanism.

Include: rate-determining step

(0.5 hour)

SLO: C12-3-09

**SUGGESTIONS FOR INSTRUCTION**

**TEACHER NOTES**

**Reaction Mechanism**

Teachers may wish to explain the concept of a reaction mechanism using the analogy of cleaning up dinner dishes by hand. This process happens in many steps: clearing the table, filling the sink with water and soap, placing the dishes in the sink, washing the dishes, drying the dishes, putting the dishes away, draining the sink, and wiping up.

Students need to be aware that an overall balanced chemical equation does not tell us much about the actual pathway a chemical reaction follows, just as an average speed of 100 km/h does not tell us much about the various speeds we need to drive on a two-hour trip.

A *reaction mechanism* summarizes the individual steps a reaction follows. Each individual step is called an *elementary step* or an *elementary process*.

Using the reaction  $2\text{NO}_{(g)} + \text{O}_{2(g)} \rightarrow 2\text{NO}_{2(g)}$ , experimental data shows that the  $\text{NO}_2$  is not formed directly from the collision of  $\text{NO}$  and  $\text{O}_2$  particles, as  $\text{N}_2\text{O}_2$  can be detected during the reaction.

A more likely scenario for the reaction is a two-step reaction mechanism:

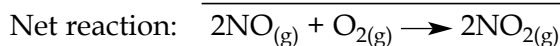
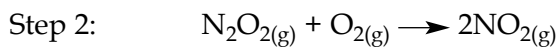

As the  $\text{N}_2\text{O}_2$  appears in the reaction mechanism but not in the overall chemical equation, it is called an *intermediate*.

**General Learning Outcome Connections**

**GLO D3:** Understand the properties and structures of matter, as well as various common manifestations and applications of the actions and interactions of matter.



## SKILLS AND ATTITUDES OUTCOMES

**C12-0-U1:** Use appropriate strategies and skills to develop an understanding of chemical concepts.

*Examples: analogies, concept frames, concept maps, manipulatives, particulate representations, role-plays, simulations, sort-and-predict frames, word cycles . . .*

**C12-0-U2:** Demonstrate an understanding of chemical concepts.

*Examples: use accurate scientific vocabulary, explain concepts to others, compare and contrast concepts, apply knowledge to new situations and/or contexts, create analogies, use manipulatives . . .*

Catalysts, like intermediates, do not appear in the overall reaction. The decomposition of ozone with a chlorine catalyst illustrates this:

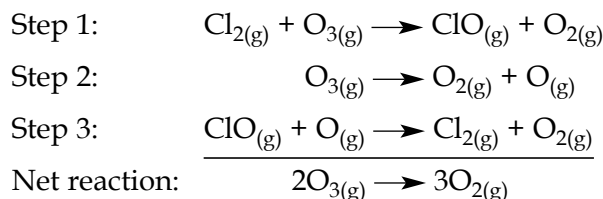

In the above example, the  $\text{Cl}_{2(g)}$  is a *catalyst* and the  $\text{ClO}_{(g)}$  is an *intermediate*.

The slowest of the elementary processes will determine the rate of the reaction. It is called the *rate-determining step*.

The rate-determining step concept can be illustrated with the analogy of cleaning up dishes, in which the longest step (washing the dishes) would be the rate-determining step. Students should recognize that efforts to speed up the other steps do not significantly affect the length of time required to clean up the dishes, but speeding up the slowest step affects the time the most.

The *molecularity* of a reaction refers to the number of particles involved in an elementary step. The molecules may be of the same type or different types. The elementary step may involve one particle (unimolecular), two particles (bimolecular), or three particles (termolecular). It is possible to use the elementary steps of a reaction to deduce a *rate law*. (Rate laws are addressed in learning outcome C12-3-10.)

*Examples of Elementary Steps:*

- **Unimolecular:** Conversion of cyclopropane to propene

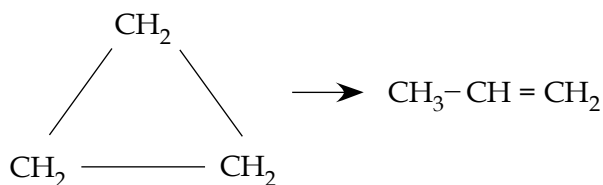

There is only one particle involved in this one-step reaction mechanism, which is the cyclopropane.

**Topic 3:  
Chemical  
Kinetics**

**SPECIFIC LEARNING OUTCOME**

**C12-3-09:** Explain the concept of a reaction mechanism.

Include: rate-determining step

(continued)

■ **Bimolecular:** Production of nitrogen dioxide

Both elementary steps for the production of nitrogen dioxide involve two particles.

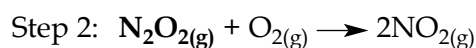
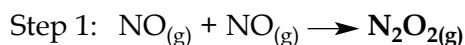

■ **Termolecular:**

Very few reactions require three particles to react simultaneously in an elementary step.

**Extension**

Have students draw potential energy diagrams for multi-step reaction mechanisms.

**SUGGESTIONS FOR ASSESSMENT**

**Paper-and-Pencil Tasks**

Ask students to create their own analogy of a reaction mechanism.

**Journal Writing**

Students can describe how they would feel and act if they were an intermediate substance in a reaction mechanism.

**LEARNING RESOURCES LINKS**



*Chemistry* (Chang 560)

*Chemistry* (Zumdahl and Zumdahl 583)

*Chemistry: The Molecular Nature of Matter and Change* (Silberberg 700)

*Glencoe Chemistry: Matter and Change* (Dingrando, et al. 548)

*McGraw-Hill Ryerson Chemistry, Combined Atlantic Edition* (Mustoe, et al. 477)

*Nelson Chemistry 12, Ontario Edition* (van Kessel, et al. 387)

*Prentice Hall Chemistry* (Wilbraham, et al. 578)

**Selecting Learning Resources**

For additional information on selecting learning resources for Grade 11 and Grade 12 Chemistry, see the Manitoba Education website at <[www.edu.gov.mb.ca/k12/learnres/bibliographies.html](http://www.edu.gov.mb.ca/k12/learnres/bibliographies.html)>.

**SKILLS AND ATTITUDES OUTCOMES**

**C12-0-U1:** Use appropriate strategies and skills to develop an understanding of chemical concepts.

*Examples: analogies, concept frames, concept maps, manipulatives, particulate representations, role-plays, simulations, sort-and-predict frames, word cycles . . .*

**C12-0-U2:** Demonstrate an understanding of chemical concepts.

*Examples: use accurate scientific vocabulary, explain concepts to others, compare and contrast concepts, apply knowledge to new situations and/or contexts, create analogies, use manipulatives . . .*

---

**NOTES**

### Topic 3: Chemical Kinetics

#### SPECIFIC LEARNING OUTCOME

**C12-3-10:** Determine the rate law and order of a chemical reaction from experimental data.

Include: zero-, first-, and second-order reactions and reaction rate versus concentration graphs

(2 hours)

SLO: C12-3-10

#### SUGGESTIONS FOR INSTRUCTION

##### TEACHER NOTES

##### Reaction Rate Laws and Reaction Order

The *differentiated rate law* is determined by using the initial rate method. The *integrated rate law* is determined by using the concentration change over time to determine rate. Avoid using the integrated rate law, as it involves the use of calculus. Instead, emphasize the use of the initial rate method. A key point to remember is that the components of the rate law must be found by experiment and not through the use of reaction stoichiometry.

Most chemistry textbooks deal with this topic in detail. Determine the depth of instruction based on students' learning requirements.

*Introductory Example:*

For the reaction  $A \rightarrow B$ , the following data was obtained.

Trial	Initial [A] (mol/L)	Initial Rate (mol/L · s)
1	0.10	5
2	0.20	10
3	0.30	15

When asked to interpret the above data, students may indicate that as the concentration went up, the initial rate also went up. (It is a proportional relationship.)

The relationship can be written as

$$\text{Rate} \propto [A]^x$$

where  $x$  is called the *order* of the reaction.

#### General Learning Outcome Connections

**GLO D3:** Understand the properties and structures of matter, as well as various common manifestations and applications of the actions and interactions of matter.

## SKILLS AND ATTITUDES OUTCOME

**C12-0-U1:** Use appropriate strategies and skills to develop an understanding of chemical concepts.

*Examples: analogies, concept frames, concept maps, manipulatives, particulate representations, role-plays, simulations, sort-and-predict frames, word cycles . . .*

The *order* describes how rate is affected by changing concentration(s) of reactant(s). For example, when doubling the concentration of a reactant results in a doubling of the rate, the reaction is a first-order reaction with respect to that reactant ( $x = 1$ ). When doubling the concentration of a reactant results in the rate increasing by four times ( $2^2$ ), the reaction is a second-order reaction with respect to that reactant ( $x = 2$ ).

To evaluate this mathematically, replace the proportionality symbol with an equal sign. To do this, a proportionality constant must be included. In this case, it is called the *rate constant* ( $k$ ).

$$\text{Rate} = k[A]^x$$

In this data,  $x$  is equal to 1.

*Sample Problem:*

For the reaction  $\text{NO}_{2(g)} + \text{CO}_{(g)} \rightarrow \text{NO}_{(g)} + \text{CO}_{2(g)}$ , the following data was obtained. Determine the overall rate law for this reaction.

Trial	Initial Rate (mol/L · s)	Initial [NO <sub>2</sub> ] (mol/L)	Initial [CO] (mol/L)
1	0.0050	0.10	0.10
2	0.080	0.40	0.10
3	0.0050	0.10	0.20

*Solution:*

1. Take the ratio of the initial rates for Trials 1 and 2, in which only one reactant is changed.

$$\frac{\text{Trial 2 } [\text{NO}_2]}{\text{Trial 1 } [\text{NO}_2]} = \frac{0.40}{0.10} = 4 \text{ times (quadrupled the concentration)}$$

$$\frac{\text{Trial 2 rate}}{\text{Trial 1 rate}} = \frac{0.080}{0.0050} = 16 \text{ times (rate increases 16 times)}$$

By increasing the concentration four times, the effect on the reaction time is that it is increased by 16. This means that the reaction rate depends on the square of the concentration of NO<sub>2</sub>. The reaction is a second-order reaction with respect to NO<sub>2</sub>.

The rate law would be

**Topic 3:**  
**Chemical**  
**Kinetics**

## SPECIFIC LEARNING OUTCOME

**C12-3-10:** Determine the rate law and order of a chemical reaction from experimental data.

Include: zero-, first-, and second-order reactions and reaction rate versus concentration graphs

(continued)

$$\text{Rate} = k[\text{NO}_2]^2$$

2. Take the ratio of the initial rates for Trials 1 and 3, in which the concentration of CO is changed.

$$\frac{\text{Trial 3 [CO]}}{\text{Trial 1 [CO]}} = \frac{0.20}{0.10} = 2 \text{ times (doubled the concentration)}$$

$$\frac{\text{Trial 3 rate}}{\text{Trial 1 rate}} = \frac{0.0050}{0.0050} = 1 \text{ time (rate does not increase)}$$

By increasing the concentration of CO, the experimental data shows that the reaction rate does not change. It does not matter how much CO there is, as the rate of reaction does not depend on [CO]. Therefore, the reaction is a zero-order reaction with respect to CO.

The rate law would be

$$\text{Rate} = k[\text{NO}_2]^2[\text{CO}]^0 = k[\text{NO}_2]^2(1) = k[\text{NO}_2]^2$$

Emphasize that the value of  $k$  is specific for each reaction and changes only for a given reaction if the temperature changes.

### Laboratory Activities

If sufficient time is available, students could perform the following lab activities:

- **Lab 14: Determining Reaction Orders** (Dingrando, et al., *Glencoe Chemistry: Small-Scale Laboratory Manual, Teacher Edition* 53)

In this lab activity, students determine the general equation for the reaction between crystal violet and sodium hydroxide.

- **Experiment 30: Rate Law Determination of the Crystal Violet Reaction** (Holmquist, Randall, and Volz, *Chemistry with Vernier*)

In this experiment, students observe the reaction between crystal violet and sodium hydroxide. They study the relationship between concentration of crystal violet and the time elapsed during the reaction.

- **Reaction Order** (PASCO, *Chemistry*)

In this experiment, students analyze the reaction rate by determining the order of the reaction when a colouring agent reacts with household bleach.

**SKILLS AND ATTITUDES OUTCOME**

**C12-0-U1:** Use appropriate strategies and skills to develop an understanding of chemical concepts.

*Examples: analogies, concept frames, concept maps, manipulatives, particulate representations, role-plays, simulations, sort-and-predict frames, word cycles . . .*

**SUGGESTIONS FOR ASSESSMENT****Paper-and-Pencil Task**

Have students solve problems involving rate laws.

**Journal Writing**

Ask students to create a table in which they “describe the effect of doubling, tripling, and quadrupling [A] on the overall rate of chemical reactions having the following rate laws:

$$\text{Rate} = k[A]^0; \text{Rate} = k[A]^1; \text{Rate} = k[A]^2; \text{Rate} = k[A]^3$$

(Dingrando, et al., *Glencoe Chemistry: Matter and Change, Teacher Wraparound Edition* 544).

**LEARNING RESOURCES LINKS**

*Chemistry* (Chang 539)

*Chemistry* (Zumdahl and Zumdahl 564)

*Chemistry: The Molecular Nature of Matter and Change* (Silberberg 679)

*Glencoe Chemistry: Matter and Change* (Dingrando, et al. 542)

*Glencoe Chemistry: Matter and Change, Teacher Wraparound Edition* (Dingrando, et al. 544)

*Nelson Chemistry 12, Ontario Edition* (van Kessel, et al. 372, 374)

*Prentice Hall Chemistry* (Wilbraham, et al. 575)

**Investigations**

*Chemistry with Calculators* (Holmquist and Volz)

*Glencoe Chemistry: Small-Scale Laboratory Manual, Teacher Edition* (Dingrando, et al. 53)

**Websites**

Holmquist, Dan D., Jack Randall, and Donald L. Volz. “Experiment 30: Rate Law Determination of the Crystal Violet Reaction.” *Chemistry with Vernier*. Beaverton, OR: Vernier, 2007. Available online at <[www.vernier.com/experiments/cwv/30/rate\\_law\\_determination\\_of\\_the\\_crystal\\_violet\\_reaction/](http://www.vernier.com/experiments/cwv/30/rate_law_determination_of_the_crystal_violet_reaction/)> (7 June 2012).

PASCO. “Reaction Order.” 1996–2012. *Chemistry*. <[www.pasco.com/chemistry/kinetics-and-equilibrium/reactionorder.cfm](http://www.pasco.com/chemistry/kinetics-and-equilibrium/reactionorder.cfm)> (9 May 2012).

**Selecting Learning Resources**

For additional information on selecting learning resources for Grade 11 and Grade 12 Chemistry, see the Manitoba Education website at <[www.edu.gov.mb.ca/k12/learnres/bibliographies.html](http://www.edu.gov.mb.ca/k12/learnres/bibliographies.html)>.





# TOPIC 3: CHEMICAL KINETICS

## APPENDICES

---

Appendix 3.1: Graphical Determination of Reaction Rate: Lab Activity	3
Appendix 3.2A: Chemical Kinetics: Assignment 1	6
Appendix 3.2B: Chemical Kinetics: Assignment 1 (Answer Key)	8
Appendix 3.3A: Chemical Kinetics: Assignment 2	11
Appendix 3.3B: Chemical Kinetics: Assignment 2 (Answer Key)	13
Appendix 3.4A: Chemical Kinetics Problems	16
Appendix 3.4B: Chemical Kinetics Problems (Answer Key)	18
Appendix 3.5A: Factors Affecting the Rate of Reactions: Lab Activity	22
Appendix 3.5B: Factors Affecting the Rate of Reactions: Lab Activity (Answer Key)	26
Appendix 3.6A: Factors Affecting the Rate of a Reaction: Lab Activity	28
Appendix 3.6B: Factors Affecting the Rate of a Reaction: Lab Activity (Teacher Notes)	31



## Appendix 3.1: Graphical Determination of Reaction Rate: Lab Activity

### Introduction

The rate of a reaction can be calculated by studying the change in the amount of a product or a reactant at different times.

The **average rate of reaction** can be calculated using the following formula:

$$\text{Average rate} = \frac{\Delta \text{ amount of substance}}{\Delta \text{ time}}$$

Or

$$\text{Average rate} = \frac{\text{amount of substance at the end} - \text{amount of substance initially}}{\text{final time} - \text{initial time}}$$

This calculation, however, is only the average rate of reaction over a time period. It would be more useful to know the rate of the reaction at a specific time during the reaction. This rate, called the *instantaneous rate of reaction*, can be determined by measuring the amount of change in a product or a reactant at several times during a reaction. Using this data, a graph can be created and the instantaneous rate of reaction can be determined by drawing a tangent to the graph at any time and finding the slope of that tangent.

In reality, calculus is needed to find this slope, but an approximation can be determined by drawing a tangent line and finding the slope (as shown in the figure below). To do this, select two points on the tangent and calculate the slope using rise over run.

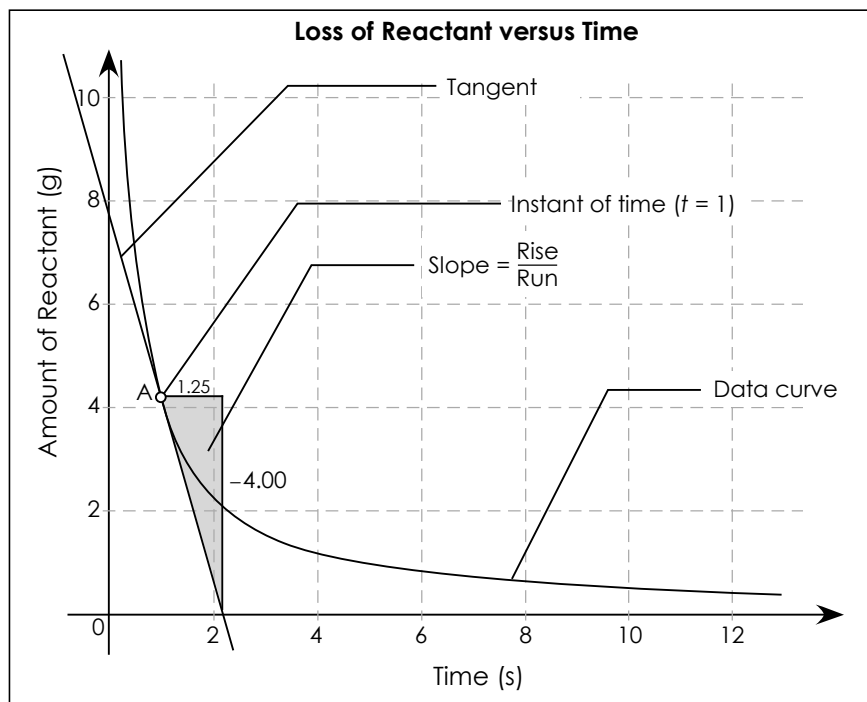

---

**Appendix 3.1: Graphical Determination of Reaction Rate: Lab Activity** *(continued)*

---

**Purpose**

In this lab activity, you will measure the loss of mass of a reactant at several times during a chemical reaction. Using the previous graph of the data, you will calculate the average and instantaneous rates of reaction.

The reaction involved is

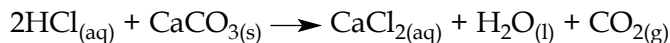

You will measure the loss of mass in this reaction as the carbon dioxide is released

**Caution:**

HCl is an acid. Gloves, goggles, and clothing protection must be worn.

**Procedure**

1. Place 10 to 12 large pieces of  $\text{CaCO}_3$  into a paper cup or on filter paper on a scale. Pour 100 mL of 3.0 mol/L HCl solution into a 500 mL beaker. Place the beaker on the scale beside the  $\text{CaCO}_3$ . Record the total mass of everything.
2. With a stopwatch ready and the beaker on the scale, the person timing the lab activity should indicate when to pour the  $\text{CaCO}_3$  chips into the acid and start the timer. Be sure to put the cup or filter paper back on the scale—it must remain there until the end of the experiment.
3. Record the mass every 30 seconds for 20 minutes.

**Questions**

1. The loss in mass in this reaction equals the amount of  $\text{CO}_2$  produced. Calculate the mass of  $\text{CO}_2$  produced for each 30-second time interval.
2. Calculate the average reaction rate. Using the average rate of reaction formula (provided at the start of this lab activity), determine the average rate of this reaction for the following time intervals:
  - a) First 5 minutes
  - b) First 10 minutes
  - c) Last 5 minutes
  - d) Last 10 minutes
  - e) From 5 to 15 minutes
  - f) For the entire 20 minutes
3. Construct a graph of mass of  $\text{CO}_2$  produced versus time.

**Appendix 3.1: Graphical Determination of Reaction Rate: Lab Activity** *(continued)*

---

4. Calculate the instantaneous rate of reaction. On your graph, mark the point, draw an approximate tangent line, and calculate the slope of the tangent for the following instants of time:
  - a) 30 seconds
  - b) 60 seconds
  - c) 5 minutes
  - d) 10 minutes
  - e) 15 minutes
  - f) 20 minutes
5. What did you observe in the rate of this reaction from beginning to end? Why does the reaction rate change over time?
6. Explain when it would be useful to know the average rate of reaction and when you would need to know the instantaneous rate of reaction.

## Appendix 3.2A: Chemical Kinetics: Assignment 1

A chemist is studying the formation of nitrogen dioxide from nitrogen monoxide and oxygen gas. The balanced equation for the reaction is:

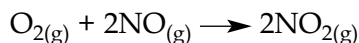

The chemist measured the concentration of the three gases at various time intervals and recorded the data in the table below.

Change in Concentration of Reactants and Products Over Time			
Time (min)	Concentration (mol/L)		
	[O <sub>2</sub> ]	[NO]	[NO <sub>2</sub> ]
0	0.000343	0.000514	0
2	0.000317	0.000461	0.000053
4	0.000289	0.000406	0.000108
6	0.000271	0.000368	0.000146
10	0.000242	0.000311	0.000204
16	0.000216	0.000259	0.000256
26	0.000189	0.000206	0.000308
41	0.000167	0.000162	0.000353
51	0.000158	0.000143	0.000372
61	0.000150	0.000127	0.000387
71	0.000144	0.000116	0.000399

### Questions

- Construct a graph to represent the data provided in the table above. Plot gas concentration along the  $y$ -axis and time on the  $x$ -axis.

Average rates over a period of time can be calculated by connecting two points on your curve with a straight line and determining the slope.

Instantaneous rates are determined by drawing a tangent line to the curve at the point of interest and determining the slope of the tangent line.

**Appendix 3.2A: Chemical Kinetics: Assignment 1** *(continued)*

---

2. What is the average rate of reaction for nitrogen oxide and oxygen and the formation of nitrogen dioxide over the entire 71-minute interval? Determine the rate for each.
3. What is the average rate of the consumption of NO and O<sub>2</sub> and the production of NO<sub>2</sub> over the first 10 minutes and over the last 10 minutes?
4. Find the instantaneous rate of consumption of O<sub>2</sub> and NO and the instantaneous rate of formation of NO<sub>2</sub> at 4 minutes and at 41 minutes into the experiment. Show your work on the graph. Explain why the rate changes.
5. What do you notice about the ratios of the rates of oxygen and nitrogen monoxide consumption to the production of nitrogen dioxide?

## Appendix 3.2B: Chemical Kinetics: Assignment 1 (Answer Key)

## Answers to Questions

1. Completed graph:

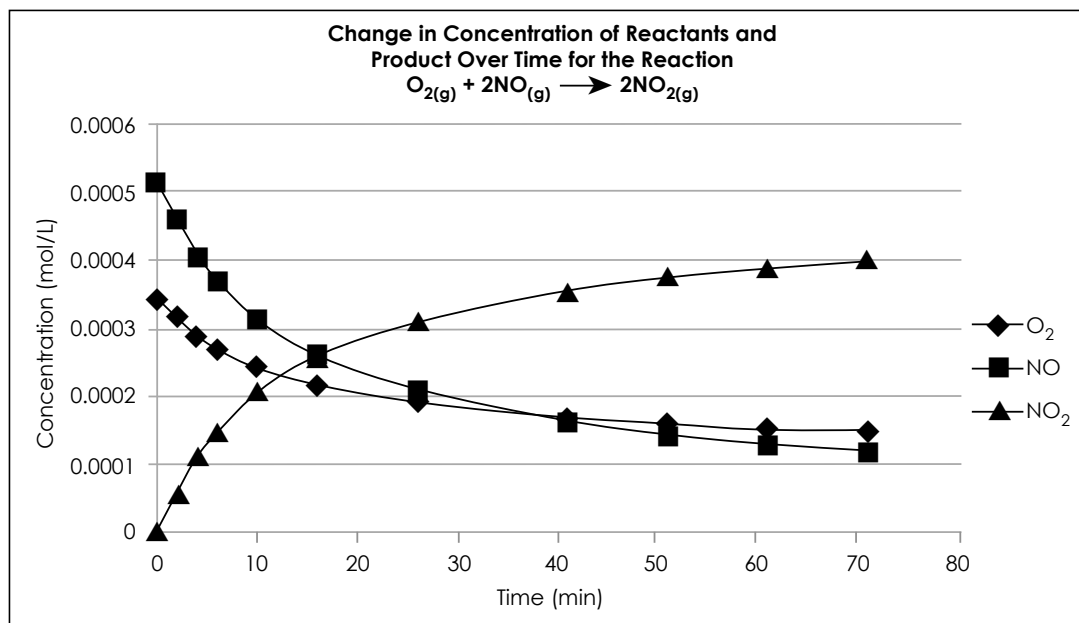

2. Over the 71-minute interval:

$$\begin{aligned} \text{Average rate for NO} &= \frac{0.000116 \text{ mol/L} - 0.000514 \text{ mol/L}}{71 \text{ min} - 0 \text{ min}} \\ &= 5.61 \times 10^{-6} \text{ mol/L} \cdot \text{min} \end{aligned}$$

$$\begin{aligned} \text{Average rate for O}_2 &= \frac{0.000144 \text{ mol/L} - 0.000343 \text{ mol/L}}{71 \text{ min} - 0 \text{ min}} \\ &= 2.80 \times 10^{-6} \text{ mol/L} \cdot \text{min} \end{aligned}$$

$$\begin{aligned} \text{Average rate for NO}_2 &= \frac{0.000399 \text{ mol/L} - 0 \text{ mol/L}}{71 \text{ min} - 0 \text{ min}} \\ &= 5.61 \times 10^{-6} \text{ mol/L} \cdot \text{min} \end{aligned}$$



## Appendix 3.2B: Chemical Kinetics: Assignment 1 (Answer Key) (continued)

3. Over the first 10 minutes:

$$\begin{aligned}\text{Average rate for NO} &= \frac{0.000311 \text{ mol/L} - 0.000514 \text{ mol/L}}{10 \text{ min} - 0 \text{ min}} \\ &= 2.03 \times 10^{-5} \text{ mol/L} \cdot \text{min}\end{aligned}$$

$$\begin{aligned}\text{Average rate for O}_2 &= \frac{0.000242 \text{ mol/L} - 0.000343 \text{ mol/L}}{10 \text{ min} - 0 \text{ min}} \\ &= 1.01 \times 10^{-5} \text{ mol/L} \cdot \text{min}\end{aligned}$$

$$\begin{aligned}\text{Average rate for NO}_2 &= \frac{0.000204 \text{ mol/L} - 0 \text{ mol/L}}{10 \text{ min} - 0 \text{ min}} \\ &= 2.04 \times 10^{-5} \text{ mol/L} \cdot \text{min}\end{aligned}$$

Over the last 10 minutes:

$$\begin{aligned}\text{Average rate for NO} &= \frac{0.000116 \text{ mol/L} - 0.000127 \text{ mol/L}}{71 \text{ min} - 61 \text{ min}} \\ &= 1.10 \times 10^{-6} \text{ mol/L} \cdot \text{min}\end{aligned}$$

$$\begin{aligned}\text{Average rate for O}_2 &= \frac{0.000144 \text{ mol/L} - 0.000150 \text{ mol/L}}{71 \text{ min} - 61 \text{ min}} \\ &= 6.00 \times 10^{-7} \text{ mol/L} \cdot \text{min}\end{aligned}$$

$$\begin{aligned}\text{Average rate for NO}_2 &= \frac{0.000399 \text{ mol/L} - 0.000387 \text{ mol/L}}{71 \text{ min} - 61 \text{ min}} \\ &= 1.20 \times 10^{-6} \text{ mol/L} \cdot \text{min}\end{aligned}$$

4. Answers will vary slightly due to the drawing of the tangent line to the point at 4 minutes.

$$\begin{aligned}\text{Instantaneous rate, NO} &= \frac{0.00028 \text{ mol/L} - 0.000485 \text{ mol/L}}{10 \text{ min} - 0 \text{ min}} \\ &= 2.05 \times 10^{-5} \text{ mol/L} \cdot \text{min}\end{aligned}$$

$$\begin{aligned}\text{Instantaneous rate, O}_2 &= \frac{0.00022 \text{ mol/L} - 0.00033 \text{ mol/L}}{10 \text{ min} - 0 \text{ min}} \\ &= 1.10 \times 10^{-5} \text{ mol/L} \cdot \text{min}\end{aligned}$$

Appendix 3.2B: Chemical Kinetics: Assignment 1 (Answer Key) (continued)

---

$$\begin{aligned}\text{Instantaneous rate, NO}_2 &= \frac{0.000242 \text{ mol/L} - 0.00003 \text{ mol/L}}{10 \text{ min} - 0 \text{ min}} \\ &= 2.12 \times 10^{-5} \text{ mol/L} \cdot \text{min}\end{aligned}$$

Answers will vary slightly due to the drawing of the tangent line to the point at 41 minutes.

$$\begin{aligned}\text{Instantaneous rate, NO} &= \frac{0.000125 \text{ mol/L} - 0.00018 \text{ mol/L}}{60 \text{ min} - 30 \text{ min}} \\ &= 1.83 \times 10^{-6} \text{ mol/L} \cdot \text{min}\end{aligned}$$

$$\begin{aligned}\text{Instantaneous rate, O}_2 &= \frac{0.00014 \text{ mol/L} - 0.00019 \text{ mol/L}}{70 \text{ min} - 20 \text{ min}} \\ &= 1.00 \times 10^{-6} \text{ mol/L} \cdot \text{min}\end{aligned}$$

$$\begin{aligned}\text{Instantaneous rate, NO}_2 &= \frac{0.000365 \text{ mol/L} - 0.000325 \text{ mol/L}}{50 \text{ min} - 30 \text{ min}} \\ &= 2.00 \times 10^{-6} \text{ mol/L} \cdot \text{min}\end{aligned}$$

5. The ratio between O<sub>2</sub> and NO<sub>2</sub> is 1:2. The rate of consumption of O<sub>2</sub> is one-half the rate of formation of NO<sub>2</sub>.

The ratio between NO and NO<sub>2</sub> is 2:2 or 1:1. The rate of consumption of NO is equal to the rate of formation of NO<sub>2</sub>.

## Appendix 3.3A: Chemical Kinetics: Assignment 2

A chemist is studying the decomposition of dinitrogen pentoxide at 45°C. The balanced equation is:

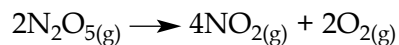

The chemist measured the concentration of dinitrogen pentoxide at 10-minute intervals for 100 minutes, using colorimetry (spectrophotometry), and recorded the data in the table below.

Decomposition of Dinitrogen Pentoxide at 45°C			
Time (min)	Concentration (mol/L)		
	[N <sub>2</sub> O <sub>5</sub> ]	[NO <sub>2</sub> ]	[O <sub>2</sub> ]
0	0.0124	0	0
10	0.0092		
20	0.0068		
30	0.0050		
40	0.0037		
50	0.0027		
60	0.0020		
70	0.0014		
80	0.0011		
90	0.0008		
100	0.0006		

Appendix 3.3A: Chemical Kinetics: Assignment 2 (continued)

---

**Questions**

1. Use the data from the table above and the balanced equation to calculate the concentration of nitrogen dioxide and oxygen gas at each interval. Then construct a graph to represent this data. Plot gas concentration along the  $y$ -axis and time on the  $x$ -axis.

Average rates over a period of time can be calculated by connecting two points on your curve with a straight line and determining the slope.

Instantaneous rates are determined by drawing a tangent line to the curve at the point of interest and determining the slope of the tangent line.

2. What is the average rate of decomposition of dinitrogen pentoxide and the formation of nitrogen dioxide and oxygen over the entire 100-minute interval? Determine the rate for each.
3. What is the average rate for the first 20 minutes of the decomposition of  $\text{N}_2\text{O}_5$  and for the last 20 minutes?
4. Find the instantaneous rate of decomposition of  $\text{N}_2\text{O}_5$  and the instantaneous rate of formation of  $\text{NO}_2$  and  $\text{O}_2$  at 10 minutes and at 80 minutes into the experiment. Show your work on the graph. Explain why the rate changes.
5. Explain why the rate changes between 10 and 80 minutes.

## Appendix 3.3B: Chemical Kinetics: Assignment 2 (Answer Key)

### Answers to Questions

1. Completed chart and graph:

Decomposition of Dinitrogen Pentoxide at 45°C			
Time (min)	Concentration (mol/L)		
	[N <sub>2</sub> O <sub>5</sub> ]	[NO <sub>2</sub> ]	[O <sub>2</sub> ]
0	0.0124	0	0
10	0.0092	0.0064	0.0032
20	0.0068	0.0112	0.0056
30	0.0050	0.0148	0.0074
40	0.0037	0.0174	0.0087
50	0.0027	0.0194	0.0097
60	0.0020	0.0208	0.0104
70	0.0014	0.0220	0.0110
80	0.0011	0.0226	0.0113
90	0.0008	0.0232	0.0116
100	0.0006	0.0236	0.0118

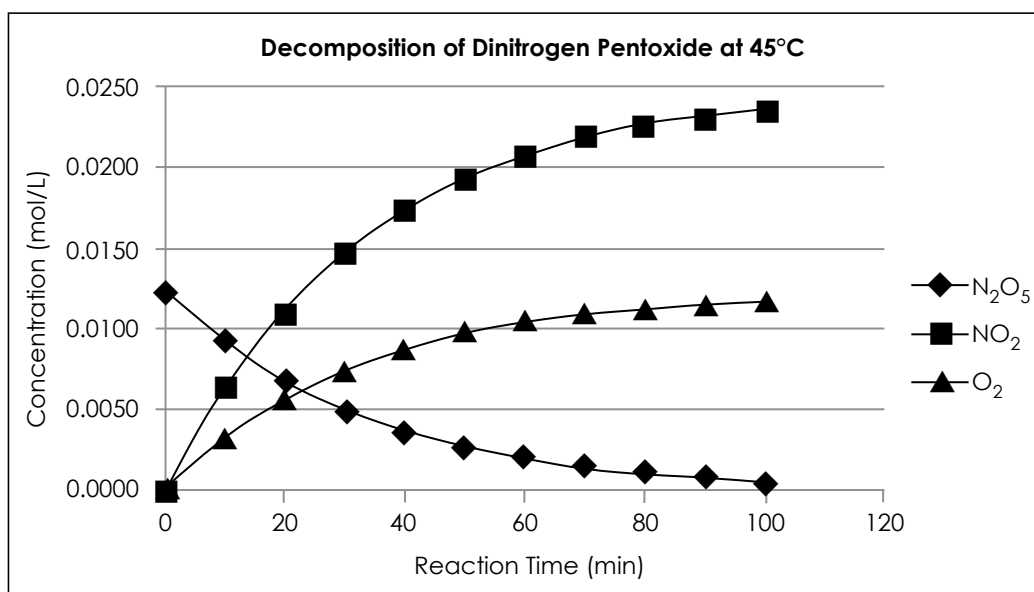

## Appendix 3.3B: Chemical Kinetics: Assignment 2 (Answer Key) (continued)

2. Over the 100-minute interval:

$$\begin{aligned}\text{Average rate for N}_2\text{O}_5 &= \frac{0.0006 \text{ mol/L} - 0.0124 \text{ mol/L}}{100 \text{ min} - 0 \text{ min}} \\ &= 1.18 \times 10^{-4} \text{ mol/L} \cdot \text{min}\end{aligned}$$

$$\begin{aligned}\text{Average rate for NO}_2 &= \frac{0.0236 \text{ mol/L} - 0 \text{ mol/L}}{100 \text{ min} - 0 \text{ min}} \\ &= 2.36 \times 10^{-4} \text{ mol/L} \cdot \text{min}\end{aligned}$$

$$\begin{aligned}\text{Average rate for O}_2 &= \frac{0.00590 \text{ mol/L} - 0 \text{ mol/L}}{100 \text{ min} - 0 \text{ min}} \\ &= 5.90 \times 10^{-5} \text{ mol/L} \cdot \text{min}\end{aligned}$$

3. Over the first 20 minutes:

$$\begin{aligned}\text{Average rate for N}_2\text{O}_5 &= \frac{0.0068 \text{ mol/L} - 0.0124 \text{ mol/L}}{20 \text{ min.} - 0 \text{ min}} \\ &= 2.80 \times 10^{-4} \text{ mol/L} \cdot \text{min}\end{aligned}$$

Over the last 20 minutes:

$$\begin{aligned}\text{Average rate for N}_2\text{O}_5 &= \frac{0.0006 \text{ mol/L} - 0.0011 \text{ mol/L}}{100 \text{ min} - 80 \text{ min}} \\ &= 2.50 \times 10^{-5} \text{ mol/L} \cdot \text{min}\end{aligned}$$

4. Answers will vary slightly due to the drawing of the tangent line to the point at 10 minutes.

$$\begin{aligned}\text{Instantaneous rate for N}_2\text{O}_5 &= \frac{0.00370 \text{ mol/L} - 0.0118 \text{ mol/L}}{30 \text{ min} - 0 \text{ min}} \\ &= 2.70 \times 10^{-4} \text{ mol/L} \cdot \text{min}\end{aligned}$$

$$\begin{aligned}\text{Instantaneous rate for NO}_2 &= \frac{0.0165 \text{ mol/L} - 0.0012 \text{ mol/L}}{30 \text{ min} - 0 \text{ min}} \\ &= 5.10 \times 10^{-4} \text{ mol/L} \cdot \text{min}\end{aligned}$$

## Appendix 3.3B: Chemical Kinetics: Assignment 2 (Answer Key) (continued)

---

$$\begin{aligned}\text{Instantaneous rate for O}_2 &= \frac{0.0025 \text{ mol/L} - 0.0004 \text{ mol/L}}{20 \text{ min} - 0 \text{ min}} \\ &= 1.05 \times 10^{-4} \text{ mol/L} \cdot \text{min}\end{aligned}$$

Answers will vary slightly due to the drawing of the tangent line to the point at 80 minutes.

$$\begin{aligned}\text{Instantaneous rate for N}_2\text{O}_5 &= \frac{0 \text{ mol/L} - 0.002 \text{ mol/L}}{115 \text{ min} - 50 \text{ min}} \\ &= 3.08 \times 10^{-5} \text{ mol/L} \cdot \text{min}\end{aligned}$$

$$\begin{aligned}\text{Instantaneous rate for NO}_2 &= \frac{0.0236 \text{ mol/L} - 0.02 \text{ mol/L}}{100 \text{ min} - 40 \text{ min}} \\ &= 6.00 \times 10^{-5} \text{ mol/L} \cdot \text{min}\end{aligned}$$

$$\begin{aligned}\text{Instantaneous rate for O}_2 &= \frac{0.00590 \text{ mol/L} - 0.00520 \text{ mol/L}}{100 \text{ min} - 60 \text{ min}} \\ &= 1.75 \times 10^{-5} \text{ mol/L} \cdot \text{min}\end{aligned}$$

5. There are fewer reactant particles available over time, so the rate gets slower as the reaction proceeds.

**Appendix 3.4A: Chemical Kinetics Problems****Problems**

1. "State three examples of properties, directly related to reactants or products, that could be used to measure a reaction rate" (van Kessel, et al. 365).
2. What would be the easiest way to measure the reaction rate in each of the following reactions? Explain your reasoning.
  - a)  $\text{MnO}_4^- (\text{aq}) + 5\text{Fe}^{2+} (\text{aq}) + 8\text{H}^+ (\text{aq}) \longrightarrow \text{Mn}^{2+} (\text{aq}) + 5\text{Fe}^{3+} (\text{aq}) + 4\text{H}_2\text{O} (\text{l})$   
(purple) (pale green) (colourless) (red-brown)
  - b)  $\text{Zn} (\text{s}) + \text{H}_2\text{SO}_4 (\text{aq}) \longrightarrow \text{H}_2 (\text{g}) + \text{ZnSO}_4 (\text{aq})$   
(silver) (colourless) (colourless) (colourless)
3. What units are used to express reaction rate?
4. In the reaction  $3\text{H}_2 + \text{N}_2 \longrightarrow 2\text{NH}_3$ , how does the rate of disappearance of hydrogen compare to the rate of disappearance of nitrogen? How does the rate of production of  $\text{NH}_3$  compare to the rate of disappearance of nitrogen?
5. For the reaction  $2\text{A} + \text{B} \longrightarrow 3\text{C}$ , it was found that the rate of consumption of B was  $0.30 \text{ mol/L}\cdot\text{s}$ . What was the rate of consumption of A and the rate of formation of C?
6. At a certain temperature, the rate of consumption of  $\text{N}_2\text{O}_5$  is  $2.5 \times 10^{-6} \text{ mol/L}\cdot\text{s}$ . How fast are  $\text{NO}_2$  and  $\text{O}_2$  being formed?
$$2\text{N}_2\text{O}_5 \longrightarrow 4\text{NO}_2 + \text{O}_2$$
7. Write the rate of expression for the following reactions:
  - a)  $\text{CH}_4 (\text{g}) + 2\text{O}_2 (\text{g}) \longrightarrow \text{CO}_2 (\text{g}) + 2\text{H}_2\text{O} (\text{g})$
  - b)  $3\text{O}_2 (\text{g}) \longrightarrow 2\text{O}_3 (\text{g})$
  - c)  $4\text{NH}_3 (\text{g}) + 5\text{O}_2 (\text{g}) \longrightarrow 4\text{NO} (\text{g}) + 6\text{H}_2\text{O} (\text{g})$
  - d)  $\text{I}^- (\text{aq}) + \text{OCl}^- (\text{aq}) \longrightarrow \text{Cl}^- (\text{aq}) + \text{OI}^- (\text{aq})$
8. In the following reaction, 4.0 mol of methane gas combusts completely in 3.2 s in a 1.00 L container containing excess oxygen gas.
$$\text{CH}_4 (\text{g}) + 2\text{O}_2 (\text{g}) \longrightarrow \text{CO}_2 (\text{g}) + 2\text{H}_2\text{O} (\text{g})$$
  - a) Calculate the average rate of consumption of oxygen gas in  $\text{mol/L}\cdot\text{s}$ .
  - b) Calculate the average rate of production of carbon dioxide gas in  $\text{mol/L}\cdot\text{s}$ .
  - c) Calculate the average rate of production of water vapour in  $\text{mol/L}\cdot\text{s}$ .



Appendix 3.4A: Chemical Kinetics Problems (continued)

---

9. Hydrogen iodide and oxygen react to form iodine gas and water vapour. If oxygen gas reacts at a rate of  $0.0042 \text{ mol/L}\cdot\text{s}$ ,

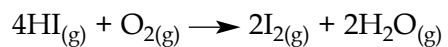

- What is the rate of formation of iodine gas in  $\text{mol/L}\cdot\text{s}$ ?
- What is the rate of formation of water vapour in  $\text{mol/L}\cdot\text{s}$ ?
- What is the rate of consumption of hydrogen iodide gas in  $\text{mol/L}\cdot\text{s}$ ?

## Appendix 3.4B: Chemical Kinetics Problems (Answer Key)

- Three examples of properties that could be used to measure reaction rate are
  - reactions that produce a gas (measure volume/pressure)
  - reactions that involve the ion as a product (conductivity)
  - reactions that produce a colour change (spectrometer – measure colour intensity)
- Observing the colour change would be the best indicator of reaction rate. When the permanganate ion ( $\text{MnO}_4^-$ ) disappears, the pink-purple colour of the solution will disappear. You may see a red-brown colour appear as the  $\text{Fe}^{3+}$  forms.
  - Because hydrogen gas is produced, you could collect the gas and measure the volume produced as time passes. Or, if the container is sealed, pressure increase could be measured.

3.  $\text{mol/L}\cdot\text{s}$

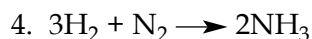

The rate of disappearance of  $\text{H}_2$  is 3 times as fast as the rate of disappearance of  $\text{N}_2$ .

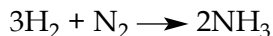

The rate of production of  $\text{NH}_3$  is 2 times as fast as the rate of disappearance of  $\text{N}_2$ .

5. The rate of consumption of A is

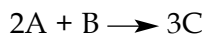

This is twice ( $2\times$ ) the rate of consumption of B ( $0.30 \text{ mol/L}\cdot\text{s}$ )

$$= 2 \times 0.30 \text{ mol/L}\cdot\text{s}$$

$$= 0.60 \text{ mol/L}\cdot\text{s}$$

The rate of formation of C is

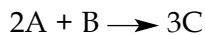

## Appendix 3.4B: Chemical Kinetics Problems (Answer Key) (continued)

This is three times (3×) the rate of consumption of B(0.30 mol/L·s)

$$= 3 \times 0.30 \text{ mol/L}\cdot\text{s}$$

$$= 0.90 \text{ mol/L}\cdot\text{s}$$

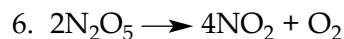

2:4 ratio, which simplifies to a 1:2 ratio.

The rate of formation of  $\text{NO}_2$  is 2 times as fast as the rate of disappearance of  $\text{N}_2\text{O}_5$ .

The rate of formation of  $\text{NO}_2 = 2 \times 2.5 \times 10^{-6} \text{ mol/L}\cdot\text{s} = 5.0 \times 10^{-6} \text{ mol/L}\cdot\text{s}$ .

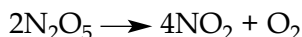

The rate of formation of  $\text{O}_2$  is half as fast as the rate of disappearance of  $\text{N}_2\text{O}_5$ .

The rate of formation of  $\text{O}_2 = 1/2 \times 2.5 \times 10^{-6} \text{ mol/L}\cdot\text{s} = 1.25 \times 10^{-6} \text{ mol/L}\cdot\text{s}$ .

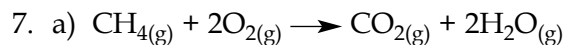

$$\text{Rate} = -\frac{\Delta[\text{CH}_4]}{\Delta t} = -\frac{1}{2} \frac{\Delta[\text{O}_2]}{\Delta t} = \frac{\Delta[\text{CO}_2]}{\Delta t} = \frac{1}{2} \frac{\Delta[\text{H}_2\text{O}]}{\Delta t}$$

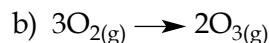

$$\text{Rate} = \frac{1}{3} \frac{\Delta[\text{O}_2]}{\Delta t} = \frac{1}{2} \frac{\Delta[\text{O}_3]}{\Delta t}$$

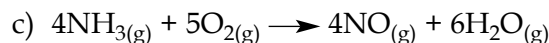

$$\text{Rate} = -\frac{1}{4} \frac{\Delta[\text{NH}_3]}{\Delta t} = -\frac{1}{5} \frac{\Delta[\text{O}_2]}{\Delta t} = \frac{1}{4} \frac{\Delta[\text{NO}]}{\Delta t} = \frac{1}{6} \frac{\Delta[\text{H}_2\text{O}]}{\Delta t}$$

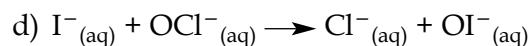

$$\text{Rate} = -\frac{\Delta[\text{I}^-]}{\Delta t} = -\frac{\Delta[\text{OCl}^-]}{\Delta t} = \frac{\Delta[\text{Cl}^-]}{\Delta t} = \frac{\Delta[\text{OI}^-]}{\Delta t}$$

## Appendix 3.4B: Chemical Kinetics Problems (Answer Key) (continued)

8. Rate of consumption of  $\text{CH}_4$  = concentration/time =  $4.0 \text{ mol/L} / 3.2 \text{ s} = 1.25 \text{ mol/L}\cdot\text{s}$

- a) Rate of consumption of  $\text{O}_2$

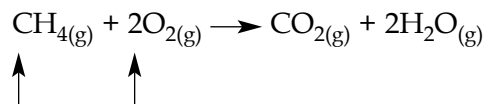

The rate of consumption of  $\text{O}_2$  is 2 times as fast as the rate of consumption of  $\text{CH}_4$ .

$$2 \times 1.25 \text{ mol/L}\cdot\text{s} = 2.50 \text{ mol/L}\cdot\text{s}$$

- b) Rate of production of  $\text{CO}_2$

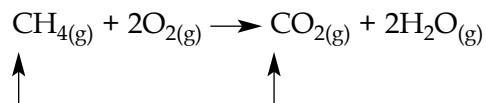

The rate of production of  $\text{CO}_2$  is the same as the rate of consumption of  $\text{CH}_4$ .

$$1 \times 1.25 \text{ mol/L}\cdot\text{s} = 1.25 \text{ mol/L}\cdot\text{s}$$

- c) Rate of production of  $\text{H}_2\text{O}$

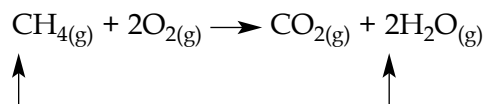

The rate of production of  $\text{H}_2\text{O}$  is 2 times as fast as the rate of consumption of  $\text{CH}_4$ .

$$2 \times 1.25 \text{ mol/L}\cdot\text{s} = 2.50 \text{ mol/L}\cdot\text{s}$$

## Appendix 3.4B: Chemical Kinetics Problems (Answer Key) (continued)

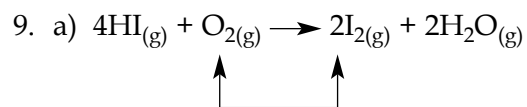

The rate of formation of  $\text{I}_2$  is 2 times as fast as the rate of consumption of  $\text{O}_2$ .

$$2 \times 0.0042 \text{ mol/L}\cdot\text{s} = 0.0084 \text{ mol/L}\cdot\text{s}$$

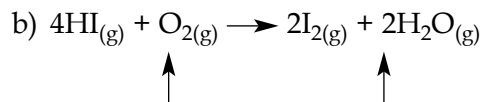

The rate of formation of  $\text{H}_2\text{O}$  is 2 times as fast as the rate of consumption of  $\text{O}_2$ .

$$2 \times 0.0042 \text{ mol/L}\cdot\text{s} = 0.0084 \text{ mol/L}\cdot\text{s}$$

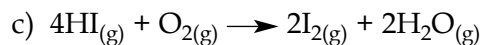

The rate of consumption of  $\text{HI}$  is 4 times as fast as the rate of consumption of  $\text{O}_2$ .

$$4 \times 0.0042 \text{ mol/L}\cdot\text{s} = 0.0168 \text{ mol/L}\cdot\text{s}$$

## Appendix 3.5A: Factors Affecting the Rate of Reactions: Lab Activity

### Teacher Notes

This is a well-known lab activity sometimes called the Iodine Clock Reaction or the Harcourt-Esson Reaction. The sudden, dramatic change in colour from a clear or cloudy, white solution to a dark, blue-black solution helps indicate the end of the reaction. By varying concentration and temperature, students can measure the time required for the colour change to occur, and thus determine the effects of these factors on the rate of the reaction.

This lab activity uses a three-step reaction that produces iodine. The iodine will then form a dark blue complex with starch.

The first and rate-determining step between iodate and metabisulphite ions generates iodide ions:



The excess iodate oxidizes the iodide to form iodine:

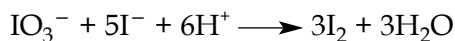

However, the iodine is reduced immediately by the metabisulphite ions back to iodide:

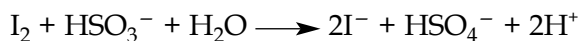

Only when the metabisulphite is fully consumed will the elemental iodine remain and react with the starch (not shown in these reactions). The solution then quickly becomes blue.

### Pre-lab Preparation

Two solutions need to be prepared for this lab activity:

- **Solution A:** Saturated potassium iodate ( $\text{KIO}_3$ )
  - You will need approximately 80 mL per lab group.
  - This solution can be prepared well in advance.

### Caution:

- Print out and review with students the Material Safety Data Sheets (MSDS) for potassium iodate, sodium metabisulphite, and sulphuric acid.
- All lab participants must wear personal safety equipment for protection of eyes, hands, and clothes.
- Spills must be properly cleaned immediately.
- Review safety procedures for using a hot plate and handling hot solutions.

---

**Appendix 3.5A: Factors Affecting the Rate of Reactions: Lab Activity** *(continued)*

---

- **Solution B:** Sodium metabisulphite ( $\text{Na}_2\text{S}_2\text{O}_5$ ), sulphuric acid ( $\text{H}_2\text{SO}_4$ ), and soluble starch
  - You will need the following per litre of water:
    - 25.0 g  $\text{Na}_2\text{S}_2\text{O}_5$
    - 5.0 mL concentrated  $\text{H}_2\text{SO}_4$
    - 40 g soluble starch
  - You will need approximately 100 mL per lab group.
  - This solution does not store well and should be mixed no earlier than the day before the lab activity.
  - To dissolve starch, start by mixing it thoroughly in a few mL of distilled water, and then pour it into boiling water (less than one litre). Once dissolved, let the water cool, add the  $\text{H}_2\text{SO}_4$ , add the  $\text{Na}_2\text{S}_2\text{O}_5$ , and stir until dissolved and bring up to 1.0 L.
  - Test the speed of the reaction beforehand. If the reaction happens too quickly to measure the time accurately, dilute the  $\text{KIO}_3$  stock solution.

**Materials (per group)**

two 100 mL beakers  
250 mL beaker  
two 10 mL graduated cylinders  
two test tubes (18 × 250 mm)  
temperature probe  
timer/stopwatch  
personal safety equipment  
hot plate  
ice  
distilled water  
paper towel  
Solution A (10 mL each trial)  
Solution B (10 mL each trial)

## Appendix 3.5A: Factors Affecting the Rate of Reactions: Lab Activity (continued)

**Procedure****Part A: Concentration of Reactants and Rate of Reaction**

1. Label or mark one graduated cylinder as **cylinder A** and one beaker as **beaker A**. Measure out exactly 10.0 mL of Solution A into this graduated cylinder and pour it into a 100 mL beaker.
2. Measure out exactly 10.0 mL of Solution B using a second graduated cylinder and pour it into another 100 mL beaker.
3. With a stopwatch ready, have the person timing the reaction give the signal to mix the solutions and start timing. Quickly pour Solution A into Solution B, and immediately swirl the solutions several times. Put the beaker on the paper towel (for contrast). When a colour change occurs, stop the watch and record the time.
4. Rinse and dry out the beakers.

Repeat steps 1 to 4, changing the concentration of Solution A by mixing the following amounts in beaker A for each trial.

Trial	mL of Solution A	mL of Distilled Water
2	9.0	1.0
3	8.0	2.0
4	7.0	3.0
5	6.0	4.0
6	5.0	5.0

**Optional:** Obtain data from other groups for their trials.

**Part B: Temperature and Reaction Rate**

1. Prepare an ice-water bath by filling a 250 mL beaker half way with cold water and ice.
2. Measure 10.0 mL of Solution A into a test tube labelled **test tube A**, and 10.0 mL of Solution B in another test tube.
3. Place the test tubes into the ice bath and leave them there until the temperature of the test tubes is equal to the ice bath. Record the temperature.
4. With a stopwatch ready, have the person timing the reaction give the signal to mix the solutions and start timing. Quickly pour Solution A into Solution B, and immediately swirl the test tube several times. Return the mixture immediately to the ice bath.
5. Stop the time when the colour change occurs. Record the time.
6. Rinse and dry the test tubes.



**Appendix 3.5A: Factors Affecting the Rate of Reactions: Lab Activity** *(continued)*

---

Repeat steps 2 to 5 with a couple of warm tap-water baths (at different temperatures) and then with an 80°C to 90°C bath using a hot plate.

Share your data with other students and obtain data from other groups to obtain a range of temperatures.

**Analysis**

1. If you have shared data from Part A with other students, calculate the average reaction rate for each trial.
2. Plot the data from the two trials (Part A and Part B) in two different graphs.

**Conclusions**

1. Make general statements about the effects of concentration and temperature on the rate of reaction.
2. Use the collision theory to explain your observations.

## Appendix 3.5B: Factors Affecting the Rate of Reactions: Lab Activity (Answer Key)

### Analysis

The graphs should look similar to the following:

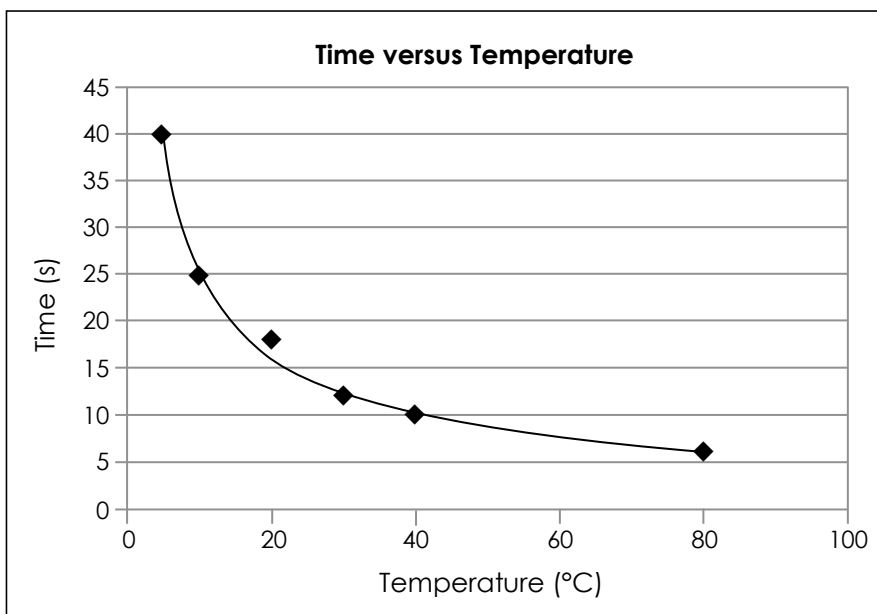
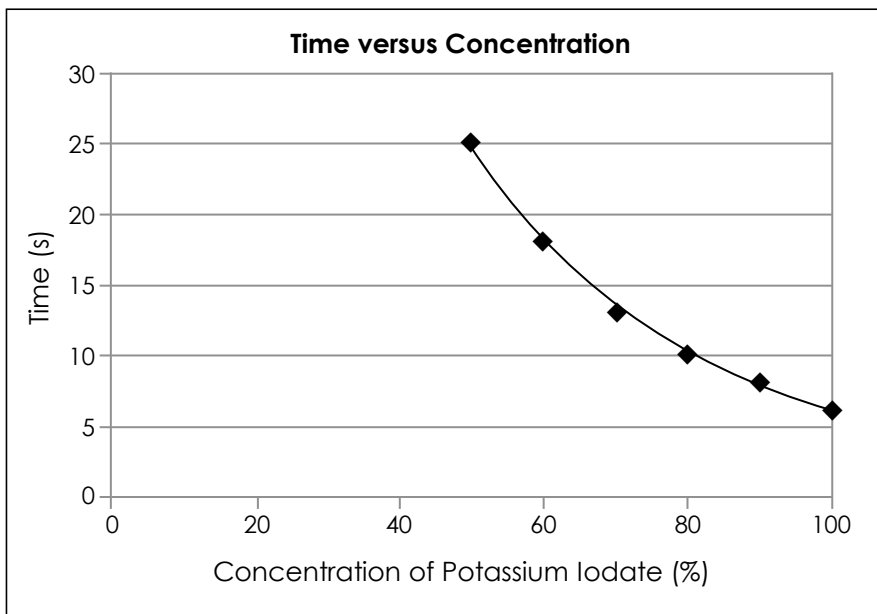

**Appendix 3.5B: Factors Affecting the Rate of Reactions: Lab Activity (Answer Key)**  
(continued)

---

**Conclusions**

1. From the graph of **Time versus Concentration**, one can conclude that there is an inverse relationship between the time it takes for a reaction to finish and the concentration of one of the reactants. This relationship is not linear – in other words, the greater the concentration, the faster the reaction.

From the graph of **Time versus Temperature**, one can conclude that there is an inverse, non-linear relationship. As the temperature increases, the speed of the reaction also increases.

2. According to the collision theory, the rate of reaction should increase (speed up) when the concentration of a reactant increases because there are more particles of the reactant present, increasing the chances of a collision with enough energy to start a reaction.

When heated, particles increase in kinetic energy, meaning that there is a higher likelihood of a collision between particles that have enough energy for the reaction to occur. Therefore, reactions proceed faster when the temperature is increased.

**Appendix 3.6A: Factors Affecting the Rate of a Reaction: Lab Activity**

---

**Part A: Nature of the Reactants**

1. Add 20 drops of 3.0 mol/L hydrochloric acid solution to each of five wells of a 24-well test plate.
2. Place a small piece of magnesium in the first well, a small piece of aluminum in the second, a small piece of zinc in the third, a piece of iron in the fourth, and a piece of copper in the fifth.
3. Observe and record your observations.

**Questions**

- What gas is produced? How do you know?
  - Write a balanced equation to represent the reaction.
  - Do all the metals take the same time to react?
  - Rank the metals in order of reactivity.
4. Add 13 drops of water and 7 drops of 3.0 mol/L hydrochloric acid solution to one well of a 24-well test plate. Stir with a glass capillary tube (sealed at one end) to mix the solution.
  5. Add 13 drops of water and 7 drops of 3.0 mol/L acetic acid solution to a second well of a 24-well test plate. Stir with a glass capillary tube to mix the solution.
  6. Add 20 drops of 1.0 mol/L aqueous zinc(II) nitrate solution to a third well, 20 drops of 1.0 mol/L iron(III) nitrate solution to a fourth well, and 20 drops of 1.0 mol/L copper(II) nitrate solution to a fifth well of the 24-well test plate.
  7. Place a small piece of magnesium in each of the five solutions.
  8. Observe and record your observations.

**Questions**

- What happened in each well? Identify the products in each case.
- Write a balanced equation to represent each reaction.
- How much time does the magnesium take to react in each solution?

---

**Appendix 3.6A: Factors Affecting the Rate of a Reaction: Lab Activity** *(continued)*

---

**Part B: Surface Area (degree of subdivision of a solid)**

1. Add 30 drops of 3.0 mol/L hydrochloric acid solution to each of four wells of a 24-well test plate.
2. To the first well, add a piece (a marble chip is suitable) of calcium carbonate ( $\text{CaCO}_3$ ). To the second well, add a similar amount of finely ground (powdered) calcium carbonate.
3. To the third well, add a piece of “mossy” zinc. To the fourth well, add a similar amount of finely divided zinc (20-mesh) or powdered zinc.
4. Observe and record your observations.

**Questions**

- What happened in each well? Identify the products in each case.
- Write a balanced equation to represent each reaction.
- How much time do the solids take to react in each solution?

**Part C: Temperature**

1. Prepare a hot water bath by heating about 150 mL of water in a 250 mL beaker to boiling. Set aside.
2. Add 2 mL of 0.01 mol/L aqueous potassium permanganate ( $\text{KMnO}_4$ ) solution (made acidic with sulphuric acid) to each of two 13 × 100 mm test tubes.
3. Place one of the test tubes of potassium permanganate solution into the hot water bath. While it is coming up to temperature, proceed to the next step.
4. Add 5 mL of 0.02 mol/L oxalic acid solution to the second test tube (at room temperature). Stir with a stirring rod.
5. Add 5 mL of 0.02 mol/L oxalic acid solution to the test tube in the hot water bath. Stir.
6. Reheat the water in your water bath to boiling, and set it aside again. Prepare a cold water bath by adding ice cubes to 50 mL of water in a 250 mL beaker.
7. Add 3 mL of water and 1 mL of 3.0 mol/L hydrochloric acid solution to each of three 13 × 100 mm test tubes. Place one of the test tubes in the hot water bath, place one in the cold water bath, and leave one at room temperature. Wait about 2 minutes for the solutions to come to temperature.

**Appendix 3.6A: Factors Affecting the Rate of a Reaction: Lab Activity** *(continued)*

---

- Cut three 0.5 cm long pieces of magnesium ribbon. Add one piece to each of the three test tubes. Observe the time required for each piece to disappear completely.

**Question**

- Does the reaction take the same time at each temperature? Explain.

**Part D: Catalyst**

- Add 2 mL of 0.01 mol/L aqueous potassium permanganate ( $\text{KMnO}_4$ ) solution (made acidic with sulphuric acid) to each of two  $13 \times 100$  mm test tubes.
- To one of the test tubes, add 5 drops of 0.01 mol/L manganese(II) sulphate solution.
- Add 5 mL of 0.02 mol/L oxalic acid solution to each of the test tubes, stopper the tubes, and shake.
- Observe and record your observations.

**Question**

- Does the reaction take the same time in each test tube? Explain.

## Appendix 3.6B: Factors Affecting the Rate of a Reaction: Lab Activity (Teacher Notes)

The four experiments demonstrate factors affecting the rate of a reaction, including

- nature (identity) of reactants
- surface area (degree of subdivision of a solid for heterogeneous reactants)
- temperature
- catalyst

### Solutions

- 3.0 mol/L hydrochloric acid solution. Dilute 258 mL of concentrated (11.6 mol/L or 36%) hydrochloric acid to 1.0 L with distilled water.
- 1.0 mol/L zinc(II) nitrate solution. Dissolve 29.7 g of zinc(II) nitrate hexahydrate,  $\text{Zn}(\text{NO}_3)_2 \cdot 6\text{H}_2\text{O}$ , in 100 mL water.
- 1.0 mol/L iron(III) nitrate solution. Dissolve 4.04 g of iron(III) nitrate nonahydrate,  $\text{Fe}(\text{NO}_3)_3 \cdot 9\text{H}_2\text{O}$ , in 100 mL water.
- 1.0 mol/L copper(II) nitrate solution. Dissolve 29.6 g of copper(II) nitrate hexahydrate,  $\text{Cu}(\text{NO}_3)_2 \cdot 6\text{H}_2\text{O}$ , in 100 mL water.
- 0.01 mol/L potassium permanganate. Add 1 mL of concentrated (17.8 mol/L or 95%) sulphuric acid to 75 mL water and add enough water to take the total volume up to 100 mL. Dissolve 1.58 g of potassium permanganate ( $\text{KMnO}_4$ ) in this solution.
- 0.02 mol/L oxalic acid solution. Dissolve 2.52 g of oxalic acid (ethanedioic acid,  $\text{HOCCOOH} \cdot 2\text{H}_2\text{O}$ ) in 100 mL water.
- 0.01 mol/L manganese(II) sulphate solution. Dissolve 2.23 g of manganese(II) sulphate tetrahydrate (manganous sulphate,  $\text{MnSO}_4 \cdot 4\text{H}_2\text{O}$ ) in 100 mL water.

### Notes

1. Sulphate compounds can be used instead of nitrate compounds. Be sure to adjust the masses used for the difference in molar mass.
2. Students may be more successful if the oxide layer is removed from the magnesium ribbon by rubbing the ribbon's surface gently with emery paper before the magnesium samples are distributed.





**TOPIC 4:**  
**CHEMICAL EQUILIBRIUM**

---



## Topic 4: Chemical Equilibrium

- C12-4-01** Relate the concept of equilibrium to physical and chemical systems.  
Include: conditions necessary to achieve equilibrium
- C12-4-02** Write equilibrium law expressions from balanced chemical equations for heterogeneous and homogeneous systems.  
Include: mass action expression
- C12-4-03** Use the value of the equilibrium constant ( $K_{\text{eq}}$ ) to explain how far a system at equilibrium has gone towards completion.
- C12-4-04** Solve problems involving equilibrium constants.
- C12-4-05** Perform a laboratory activity to determine the equilibrium constant of an equilibrium system.
- C12-4-06** Use Le Châtelier's principle to predict and explain shifts in equilibrium.  
Include: temperature changes, pressure/volume changes, changes in reactant/product concentration, the addition of a catalyst, the addition of an inert gas, and the effects of various stresses on the equilibrium constant
- C12-4-07** Perform a laboratory activity to demonstrate Le Châtelier's principle.
- C12-4-08** Interpret concentration versus time graphs.  
Include: temperature changes, concentration changes, and the addition of a catalyst
- C12-4-09** Describe practical applications of Le Châtelier's principle.  
*Examples: Haber process, hemoglobin production at high altitude, carbonated beverages, eyes adjusting to light, blood pH, recharging of batteries, turbocharged/supercharged engines, ester synthesis, weather indicators, arrangement of produce, carbonated beverages in a hen's diet . . .*
- C12-4-10** Write solubility product ( $K_{\text{sp}}$ ) expressions from balanced chemical equations for salts with low solubility.
- C12-4-11** Solve problems involving  $K_{\text{sp}}$ .  
Include: common ion problems
- C12-4-12** Describe examples of the practical applications of salts with low solubility.  
*Examples: kidney stones, limestone caverns, osteoporosis, tooth decay . . .*
- C12-4-13** Perform a laboratory activity to determine the  $K_{\text{sp}}$  of a salt with low solubility.

**Suggested Time: 17 hours**

**Topic 4:  
Chemical  
Equilibrium**

**SPECIFIC LEARNING OUTCOME**

**C12-4-01:** Relate the concept of equilibrium to physical and chemical systems.

Include: conditions necessary to achieve equilibrium

(1 hour)

SLO: C12-4-01

**SUGGESTIONS FOR INSTRUCTION**

**Entry-Level Knowledge**

In Grade 9 Science (S1-2-12), students were introduced to the difference between physical and chemical changes. In Grade 11 Chemistry (C11-1-05, C11-1-06), students were introduced to the concept of equilibrium with respect to the rates of evaporation and condensation of a liquid in a closed container. They further developed analogies to help them understand the concept.

**Assessing Prior Knowledge**

Check for students' prior knowledge, and review concepts as necessary. Prior knowledge can be reviewed and/or assessed by using any of the KWL strategies (e.g., Concept Map, Knowledge Chart, Think-Pair-Share – see *SYSTH*, Chapter 9).

**Activation Demonstration: Blue Bottle Reaction**

Introduce the topic of chemical equilibrium with a demonstration showing the reversibility of chemical reactions. The classic blue bottle reaction demonstration clearly shows a reversible reaction. In a 1000 mL Erlenmeyer flask, dissolve 14 g of sodium hydroxide (NaOH) in 700 mL distilled water. Add 14 g of dextrose (or glucose) and 1 mL methylene blue to the NaOH solution. Stopper the flask tightly. Shake it vigorously and observe that the solution turns blue. Allow the solution to sit, and observe that the colour clears. This system involves the oxidation of dextrose (or glucose) by oxygen (caused by shaking the flask). The methylene blue acts as a catalyst for this reaction. Have students describe the reaction in the flask and speculate why the solution does not stay blue.

Demonstrations of the blue bottle reaction can be viewed on various websites.

*Sample Website:*

The North Carolina School of Science and Mathematics (NCSSM). "Chapter 14: Gas Phase, Solubility, Complex Ion Equilibria." *Chemistry Online Resource Essentials (CORE)*. <[www.dlt.ncssm.edu/core/c14.htm](http://www.dlt.ncssm.edu/core/c14.htm)> (15 Feb. 2012).

A video entitled *Blue Bottle Equilibrium* can be viewed on this website.

**General Learning Outcome Connections**

**GLO D3:** Understand the properties and structures of matter, as well as various common manifestations and applications of the actions and interactions of matter.

**SKILLS AND ATTITUDES OUTCOMES**

**C12-0-U1:** Use appropriate strategies and skills to develop an understanding of chemical concepts.

*Examples: analogies, concept frames, concept maps, manipulatives, particulate representations, role-plays, simulations, sort-and-predict frames, word cycles . . .*

**C12-0-U2:** Demonstrate an understanding of chemical concepts.

*Examples: use accurate scientific vocabulary, explain concepts to others, compare and contrast concepts, apply knowledge to new situations and/or contexts, create analogies, use manipulatives . . .*

**TEACHER NOTES****Reversible Reactions for Physical Equilibrium**

Up to this point, this chemistry curriculum has addressed reversibility in physical systems (i.e., phase changes and dissociation). Students will now be introduced to the potential for reversibility in chemical systems. Discuss the conditions that are necessary to achieve equilibrium in physical and chemical systems and emphasize the differences between the two systems.

Physical equilibria require a closed system at constant temperature. Examples of physical equilibria are evaporation and dissolving.

*Examples:*

In the diagram below, water ( $\text{H}_2\text{O}_{(l)}$ ) is in equilibrium with its vapour ( $\text{H}_2\text{O}_{(g)}$ ). The rate of evaporation is equal to the rate of condensation in a closed container at a constant temperature. At the particulate level, for every one molecule of water ( $\text{H}_2\text{O}_{(l)}$ ) that evaporates, another water vapour molecule ( $\text{H}_2\text{O}_{(g)}$ ) condenses to the liquid state. This is an example of a reversible reaction for a physical equilibrium.

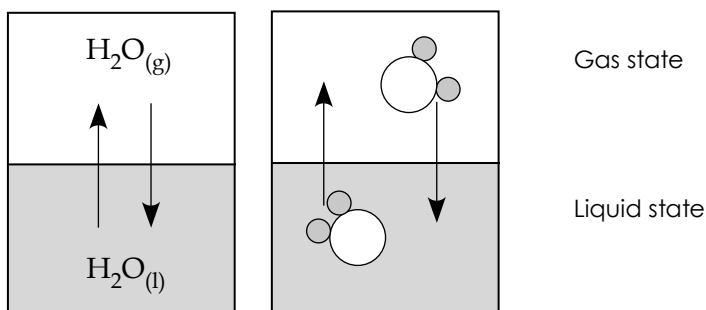

**Topic 4:  
Chemical  
Equilibrium****SPECIFIC LEARNING OUTCOME****C12-4-01:** Relate the concept of equilibrium to physical and chemical systems.

Include: conditions necessary to achieve equilibrium

*(continued)*

---

**Animation**

Have students view an equilibrium animation online.

*Sample Website:*

Chemical Education Research Group, Iowa State University. "Chemistry Experiment Simulations and Conceptual Computer Animations." *Chemical Education*. <<http://group.chem.iastate.edu/Greenbowe/sections/projectfolder/simDownload/index4.html>> (22 Nov. 2012).

In the General Equilibria section, download and unzip the following animation:

## ■ Bromine Liquid-Gas Equilibrium Animation

This animation shows the molecular nature between liquid bromine and gaseous bromine. Have students count the number of molecules in the gas phase and in the liquid phase.

**Reversible Reaction for Chemical Equilibrium**

The conditions required for chemical equilibria include constant observable macroscopic properties (e.g., temperature, pressure, concentration), a closed system, constant temperature, reversibility, and equal rates of opposing change (Chastko 637).

*Example:*

An example of a reversible reaction for a chemical equilibrium is

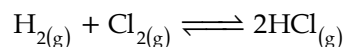

At the particulate level for this reaction, the rate of forward reaction is equal to the rate of the reverse reaction. This means that for every molecule of H<sub>2</sub> that combines with a molecule of Cl<sub>2</sub>, there is one molecule of HCl that reacts with another molecule of HCl, which reform to make the reactants H<sub>2</sub> and Cl<sub>2</sub>. For a particulate representation of this reversible reaction, see the following diagram.

## SKILLS AND ATTITUDES OUTCOMES

**C12-0-U1:** Use appropriate strategies and skills to develop an understanding of chemical concepts.

*Examples: analogies, concept frames, concept maps, manipulatives, particulate representations, role-plays, simulations, sort-and-predict frames, word cycles . . .*

**C12-0-U2:** Demonstrate an understanding of chemical concepts.

*Examples: use accurate scientific vocabulary, explain concepts to others, compare and contrast concepts, apply knowledge to new situations and/or contexts, create analogies, use manipulatives . . .*

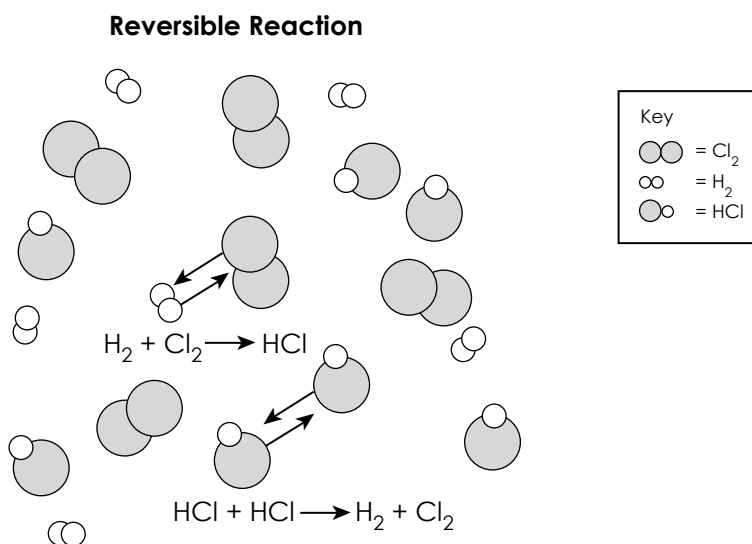

The diagram shows  $\text{H}_2 + \text{Cl}_2$  combining to form two molecules of HCl, and two molecules of HCl combining to reform  $\text{H}_2 + \text{Cl}_2$ .

**Demonstration/Animation**

Demonstrate a chemical equilibrium with an  $\text{NO}_2 - \text{N}_2\text{O}_4$  system or a  $\text{CoCl}_4^{2-} - \text{Co}(\text{H}_2\text{O})_6^{2+}$  system. See Appendix 4.1: Preparation of Equilibrium Systems (Demonstration) for preparation instructions. Sealed units of  $\text{NO}_2 - \text{N}_2\text{O}_4$  can be purchased from science supply companies rather than preparing the tubes for classroom demonstration.

Have students view an online demonstration or animation of a chemical equilibrium.

*Sample Website:*

Chemical Education Research Group, Iowa State University. "Chemistry Experiment Simulations and Conceptual Computer Animations." *Chemical Education*. <<http://group.chem.iastate.edu/Greenbowe/sections/projectfolder/simDownload/index4.html>> (22 Nov. 2012).

In the General Equilibria section, download and unzip the following animation:

- $\text{NO}_2 - \text{N}_2\text{O}_4$  Equilibrium Animation

This animation shows the  $\text{NO}_2 - \text{N}_2\text{O}_4$  reaction at the particulate level.

**Topic 4:  
Chemical  
Equilibrium**

**SPECIFIC LEARNING OUTCOME**

**C12-4-01:** Relate the concept of equilibrium to physical and chemical systems.

Include: conditions necessary to achieve equilibrium

(continued)

**Graphs**

How systems achieve equilibrium can be demonstrated through concentration versus time graphs and rate versus time graphs, such as the following.

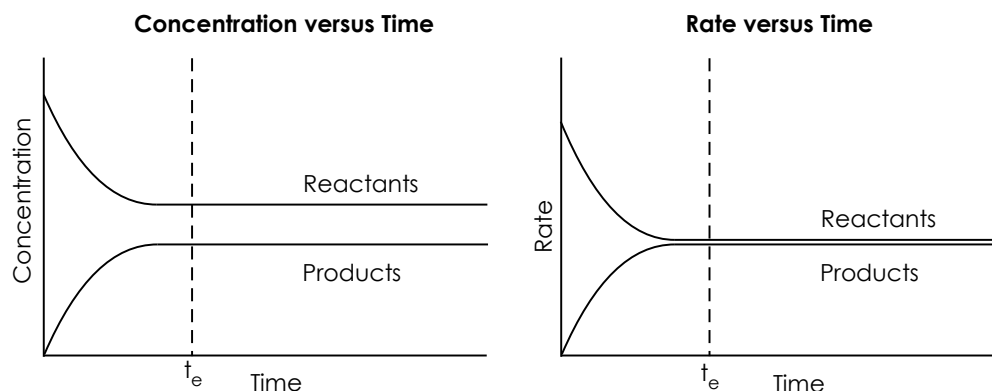

To prevent the misconception that equilibrium has been achieved by the end of the plateau, point out to students that equilibrium occurs as soon as the plateau begins.

Avoid a quantitative discussion of these graphs at this point.

**Learning Activity: The Process of Achieving Equilibrium**

Have a group of students represent sodium and chloride ions in the following reaction:

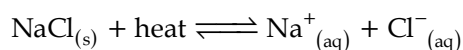

For example, in a class of 20 students, 10 students could represent sodium ions and 10 students could represent chloride ions. Have 4 sodium ions and 4 chloride ions link arms on the left side of the room to represent sodium chloride particles. Have the remaining 12 students stand on the right side of the room. Ask a student to record on the board the number of each type of particles.

At this point, explain that in order for sodium chloride to break apart, heat is required. Place on the floor four pieces of red construction paper (to represent the heat), which can be picked up by the students representing the sodium chloride particles so that they can break up into sodium and chloride ions and move to the right side of the room. (The sodium ions in the sodium chloride particle should hold onto the heat). Students on the right side of the room could use the heat to join together to form a sodium chloride particle and move to the left side of the room.



**SKILLS AND ATTITUDES OUTCOMES**

**C12-0-U1:** Use appropriate strategies and skills to develop an understanding of chemical concepts.

*Examples: analogies, concept frames, concept maps, manipulatives, particulate representations, role-plays, simulations, sort-and-predict frames, word cycles . . .*

**C12-0-U2:** Demonstrate an understanding of chemical concepts.

*Examples: use accurate scientific vocabulary, explain concepts to others, compare and contrast concepts, apply knowledge to new situations and/or contexts, create analogies, use manipulatives . . .*

---

Allow this movement to continue for a few minutes, and then have a student record the number of each particle a second time. Repeat this process once more so that students can see that equilibrium has occurred.

Emphasize that the process of equilibrium is not finished. The forward and reverse processes continue to occur.

**Laboratory Activity**

Have students perform the Discovery Lab: What's equal about equilibrium? (Dingrando, et al. 559).

For this lab activity, students pour 20 mL of water into a graduated cylinder and 20 mL into a beaker. They then place one glass tube in the cylinder and another glass tube in the beaker. Students cover the end of each glass tube with their index fingers and simultaneously transfer water from the cylinder to the beaker, and from the beaker to the cylinder. The heights will even out after a number of transfers.

Equilibrium is established with 30 mL in the beaker and 10 mL in the graduated cylinder.

**SUGGESTIONS FOR ASSESSMENT**

---

**Paper-and-Pencil Tasks**

1. Students can complete a Compare and Contrast think sheet for the following: physical and chemical systems and open and closed systems.
2. Present students with examples of situations showing systems that are at equilibrium and systems that are not at equilibrium. Have them identify both types of systems.
3. Provide students with data tables and ask them to identify whether or not the reactions are at equilibrium.

**Topic 4:  
Chemical  
Equilibrium****SPECIFIC LEARNING OUTCOME****C12-4-01:** Relate the concept of equilibrium to physical and chemical systems.

Include: conditions necessary to achieve equilibrium

*(continued)*

---

**Journal Writing**

1. Ask students to list reactions that are reversible (e.g., dissolving salt in water) and reactions that are not reversible (e.g., burning paper).
2. Have students answer the following question:  
At equilibrium, does the concentration of reactant have to equal the concentration of product? Explain your answer.

*Answer:*

No, the concentrations must be constant over time. They will not necessarily be equal.

**LEARNING RESOURCES LINKS**

---

*Chemistry* (Chang 586)*Chemistry* (Zumdahl and Zumdahl 612)*Glencoe Chemistry: Concepts and Applications* (Phillips, Strozak, and Wistrom 211)*Glencoe Chemistry: Matter and Change* (Dingrando, et al. 559, 560)*McGraw-Hill Ryerson Chemistry*, Combined Atlantic Edition (Mustoe, et al. 489, 492)*McGraw-Hill Ryerson Inquiry into Chemistry* (Chastko, et al. 634, 636)*Nelson Chemistry 12*, Ontario Edition (van Kessel, et al. 424)*Prentice Hall Chemistry* (Wilbraham, et al. 549)**Investigation***Glencoe Chemistry: Matter and Change* (Dingrando, et al.)

Discovery Lab: What's equal about equilibrium? 559

**Website**

Chemical Education Research Group, Iowa State University. "Chemistry Experiment Simulations and Conceptual Computer Animations." *Chemical Education*. <<http://group.chem.iastate.edu/Greenbowe/sections/projectfolder/simDownload/index4.html>> (22 Nov. 2012).

Animations: Bromine Liquid-Gas Equilibrium Animation  
NO<sub>2</sub>-N<sub>2</sub>O<sub>4</sub> Equilibrium Animation

**SKILLS AND ATTITUDES OUTCOMES**

**C12-0-U1:** Use appropriate strategies and skills to develop an understanding of chemical concepts.

*Examples: analogies, concept frames, concept maps, manipulatives, particulate representations, role-plays, simulations, sort-and-predict frames, word cycles . . .*

**C12-0-U2:** Demonstrate an understanding of chemical concepts.

*Examples: use accurate scientific vocabulary, explain concepts to others, compare and contrast concepts, apply knowledge to new situations and/or contexts, create analogies, use manipulatives . . .*

---

**Appendix**

Appendix 4.1: Preparation of Equilibrium Systems (Demonstration)

**Selecting Learning Resources**

For additional information on selecting learning resources for Grade 11 and Grade 12 Chemistry, see the Manitoba Education website at <[www.edu.gov.mb.ca/k12/learnres/bibliographies.html](http://www.edu.gov.mb.ca/k12/learnres/bibliographies.html)>.

## Topic 4: Chemical Equilibrium

### SPECIFIC LEARNING OUTCOMES

**C12-4-02:** Write equilibrium law expressions from balanced chemical equations for heterogeneous and homogeneous systems.  
Include: mass action expression

**C12-4-03:** Use the value of the equilibrium constant ( $K_{eq}$ ) to explain how far a system at equilibrium has gone towards completion.

**C12-4-04:** Solve problems involving equilibrium constants.

(3.5 hours)

SLO: C12-4-02  
SLO: C12-4-03  
SLO: C12-4-04

### SUGGESTIONS FOR INSTRUCTION

#### Entry-Level Knowledge

In Grade 7 Science (7-2-14), students were introduced to heterogeneous and homogeneous solutions.

#### Assessing Prior Knowledge

Check for students' prior knowledge, and review concepts as necessary.

### TEACHER NOTES

#### Equilibrium Expressions

The ratio of product concentrations (raised to the value of the coefficient from the balanced equation) to reactant concentrations (raised to the value of the coefficient from the balanced equation) in a reaction at equilibrium is represented by the *equilibrium law expression (mass action expression)*. The law of mass action was introduced in 1864 by Cato Maximilian Guldberg and Peter Waage, two Norwegian chemists who “analyzed the results of many different experiments and tested a variety of mathematical relationships until they discovered the relationship that always gave consistent results” (Chastko 640).

#### “Equilibrium Law Expression

$$K_c = \frac{[C]^c [D]^d}{[A]^a [B]^b}$$

Where [A], [B], [C], and [D] represent the concentrations of the reactants and products after the reaction has reached equilibrium and the concentrations no longer change. The exponents,  $a$ ,  $b$ ,  $c$ , and  $d$ , are the stoichiometric coefficients from the equation” (Chastko 641).

A general equilibrium reaction can be written as follows:

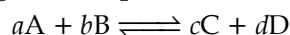

### General Learning Outcome Connections

**GLO D3:** Understand the properties and structures of matter, as well as various common manifestations and applications of the actions and interactions of matter.

**SKILLS AND ATTITUDES OUTCOME**

**C12-0-U1:** Use appropriate strategies and skills to develop an understanding of chemical concepts.

*Examples: analogies, concept frames, concept maps, manipulatives, particulate representations, role-plays, simulations, sort-and-predict frames, word cycles . . .*

**Equilibrium Constants**

Solids and liquids are not included in the mass action expression, as their concentrations are constant. Regardless of how much of the solid or liquid is present, the concentration (mol/L) of the solid and liquid remains the same. The value of the mass action expression at any point in time is called the *reaction quotient* ( $Q$ ). At equilibrium, it is called the *equilibrium constant* ( $K_{eq}$ ). Inform students that equilibrium constants are specific for only one reaction at a particular temperature.

The equilibrium constant provides information such as how far a reaction has gone toward completion before it reaches equilibrium. Because the equilibrium constant is the ratio of products to reactants, a  $K_{eq}$  value greater than 1 ( $K_{eq} > 1$ ) means that there were more products than reactants, so the reaction was close to completion when equilibrium was achieved (and vice versa).

Many chemistry textbooks use the symbol  $K_{eq}$  to represent the equilibrium constant. Unless the value is given with appropriate units, this symbol does not distinguish between a constant equilibrium value calculated from equilibrium concentrations ( $K_c$ ) and that calculated from equilibrium pressure ( $K_p$ ). In textbooks, units are not used because they would vary depending on the powers to which the concentrations are raised. In some cases, all units would cancel.

**Problems Involving Equilibrium Constants**

Problems should be limited to

- solving for  $K_{eq}$  given equilibrium concentrations of all reactants and products
- solving for an equilibrium concentration when  $K_{eq}$  and the equilibrium concentrations of all remaining reactants and products are given
- using an ICE table to solve for  $K_{eq}$  given an initial concentration or an equilibrium concentration of one of the products (see Appendix 4.2: Solving Equilibrium Problems Using the ICE Table Method and Appendix 4.3: Solving for  $K_{eq}$  Using the BIR/PEC Accounting Method).

**ICE Table**

- I** Initial—the initial concentrations of the reactants and products
- C** Change—the change in reactants and products from the initial conditions
- E** Equilibrium—the concentrations of the reactants and products at equilibrium

**BIR/PEC Accounting Method**

- B** Balanced equation
- I** Initial (moles)
- R/P** Reacted or produced (moles)
- E** Equilibrium (moles)
- C** Concentration (mol/L)

**Topic 4:  
Chemical  
Equilibrium**

---

**SPECIFIC LEARNING OUTCOMES**

**C12-4-02:** Write equilibrium law expressions from balanced chemical equations for heterogeneous and homogeneous systems.  
Include: mass action expression

**C12-4-03:** Use the value of the equilibrium constant ( $K_{\text{eq}}$ ) to explain how far a system at equilibrium has gone towards completion.

**C12-4-04:** Solve problems involving equilibrium constants.

(continued)

---

Note that

. . . students need extra practice using their calculators to solve problems involving scientific notation. In particular, students commonly make the mistake of using the times ( $\times$ ) sign when entering scientific-notation numbers. Point out that the exponent key ([EXP] on most calculators . . . or [EE] on others) actually represents ' $\times 10$ .' To help students with this process, lead them through entering several numbers in scientific-notation and carrying out calculations with the numbers. (Dingrando, et al., *Glencoe Chemistry: Matter and Change, Teacher Wraparound Edition* 579)

**Learning Activity: Determining Mathematical Relationships**

Students can work in groups to determine a mathematical relationship between the equilibrium concentrations of reactants and products in a given data set.

*Sample Problem: Mathematical Relationships*

Your supervisor in the chemistry lab wants you to determine a mathematical relationship for the data found from studying the following chemical equilibrium:

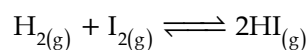

What mathematical formula using equilibrium concentrations of reactants and products gives a constant ( $K$ ) for the hydrogen iodide reaction system?

Hints:

- Be sure to analyze all your data to test your formula.
- Remember that the rate of the forward reaction is equal to the rate of the reverse reaction at equilibrium.

**SKILLS AND ATTITUDES OUTCOME**
**C12-0-U1:** Use appropriate strategies and skills to develop an understanding of chemical concepts.

*Examples: analogies, concept frames, concept maps, manipulatives, particulate representations, role-plays, simulations, sort-and-predict frames, word cycles . . .*

Trial	[H <sub>2</sub> ] (mol/L)	[I <sub>2</sub> ] (mol/L)	[HI] (mol/L)	$\frac{[\text{reactants}]}{[\text{products}]^2}$	$\frac{[\text{products}]^2}{[\text{reactants}]}$
1	0.0032583	0.0012949	0.015869	0.02	60
2	0.0046981	0.0007014	0.013997	0.02	60
3	0.0010084	0.0010084	0.007816	0.02	60
4	0.0007106	0.0007106	0.005468	0.02	60
5	0.0013953	0.0013953	0.010791	0.02	60

*Solution:*

$$\text{Rate}_{\text{forward}} = k_f[\text{H}_2][\text{I}_2]$$

$$\text{Rate}_{\text{reverse}} = k_r[\text{HI}]^2$$

At equilibrium,

$$\text{Rate}_{\text{forward}} = \text{Rate}_{\text{reverse}}$$

So,

$$k_f[\text{H}_2][\text{I}_2] = k_r[\text{HI}]^2$$

**Note:** We can't cancel the  $k$  values, as they are not identical to one another.

$$\frac{k_f}{k_r} = \frac{[\text{HI}]^2}{[\text{H}_2][\text{I}_2]}$$

or

$$\frac{k_r}{k_f} = \frac{[\text{H}_2][\text{I}_2]}{[\text{HI}]^2}$$

If the concentrations for the first trial are substituted into this equation, the value obtained is

$$\frac{k_f}{k_r} = \frac{[\text{HI}]^2}{[\text{H}_2][\text{I}_2]} = \frac{(0.015869)^2}{(0.0032583)(0.0012949)} = 59.6$$

Using the same concentrations for the first trial and substituting these values into the second equation, the result is

$$\frac{k_r}{k_f} = \frac{[\text{H}_2][\text{I}_2]}{[\text{HI}]^2} = \frac{(0.0032583)(0.0012949)}{(0.015869)^2} = 0.017$$

**Topic 4:  
Chemical  
Equilibrium**

**SPECIFIC LEARNING OUTCOMES**

**C12-4-02:** Write equilibrium law expressions from balanced chemical equations for heterogeneous and homogeneous systems.  
Include: mass action expression

**C12-4-03:** Use the value of the equilibrium constant ( $K_{\text{eq}}$ ) to explain how far a system at equilibrium has gone towards completion.

**C12-4-04:** Solve problems involving equilibrium constants.

(continued)

Student groups should obtain answers in the order of 60 or 0.02 when using the concentrations given in the other trials. Inform students that scientists have collectively agreed that the equilibrium constants would be reported in texts such as the *CRC Handbook of Chemistry and Physics* (CRC Press), using the ratio of product to reactant concentrations, or

$$\frac{k_f}{k_r} = \frac{[\text{HI}]^2}{[\text{H}_2][\text{I}_2]} = K_{\text{eq}}$$

**Sample Problem: Heterogeneous Equilibrium**

Write the mass action expression for the decomposition of solid calcium carbonate.

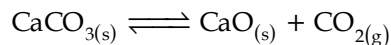

*Solution:*

In applying the standard form of the mass action expression, the equation would be written as follows:

$$K_{\text{eq}} = \frac{[\text{CaO}][\text{CO}_2]}{[\text{CaCO}_3]}$$

However, the concentrations of pure solids and liquids are constant (i.e., they cannot change). They are not included in the mass action expression, so the mass action expression for the decomposition of calcium carbonate is

$$K_{\text{eq}} = [\text{CO}_2]$$



**SKILLS AND ATTITUDES OUTCOME**

**C12-0-U1:** Use appropriate strategies and skills to develop an understanding of chemical concepts.

*Examples: analogies, concept frames, concept maps, manipulatives, particulate representations, role-plays, simulations, sort-and-predict frames, word cycles . . .*

---

**SUGGESTIONS FOR ASSESSMENT**

---

**Paper-and-Pencil Tasks**

1. Students can write equilibrium law expressions from given chemical equations and write chemical equations from equilibrium law expressions.
2. Have students use process notes to show the derivation of a mass action expression for a reaction that involves solids and/or liquids.
3. Provide students with various  $K_{\text{eq}}$  values and have them identify which reactions were close to completion when equilibrium was achieved and which were not.
4. Have students solve problems involving equilibrium constants (see Appendix 4.4: Equilibrium Problems).

**Journal Writing**

Ask students to “research the work of the Norwegian chemists Cato Maximilian Guldberg and Peter Waage that led them to propose the law of mass action. Have them describe how the law of mass action results in the formatting of equilibrium constant expressions” (Dingrando, et al., *Chemistry: Matter and Change, Teacher Wraparound Edition* 563).

**LEARNING RESOURCES LINKS**

---



*Chemistry* (Chang 587, 588, 600)

*Chemistry* (Zumdahl and Zumdahl 615)

*Chemistry: The Molecular Nature of Matter and Change* (Silberberg 723, 736)

*CRC Handbook of Chemistry and Physics* (CRC Press)—“The Rubber Book”

*Glencoe Chemistry: Matter and Change* (Dingrando, et al. 563)

*Glencoe Chemistry: Matter and Change, Teacher Wraparound Edition* (Dingrando, et al. 563, 579)

*McGraw-Hill Ryerson Chemistry, Combined Atlantic Edition* (Mustoe, et al. 494, 505)

*McGraw-Hill Ryerson Inquiry into Chemistry* (Chastko, et al. 639–641, 656)

*Nelson Chemistry 12, Ontario Edition* (van Kessel, et al. 433, 439)

*Prentice Hall Chemistry* (Wilbraham, et al. 556)

**Topic 4:  
Chemical  
Equilibrium**

---

**SPECIFIC LEARNING OUTCOMES**

- C12-4-02:** Write equilibrium law expressions from balanced chemical equations for heterogeneous and homogeneous systems.  
Include: mass action expression
- C12-4-03:** Use the value of the equilibrium constant ( $K_{\text{eq}}$ ) to explain how far a system at equilibrium has gone towards completion.
- C12-4-04:** Solve problems involving equilibrium constants.

(continued)

---

**Appendices**

Appendix 4.2: Solving Equilibrium Problems Using the ICE Table Method

Appendix 4.3: Solving for  $K_{\text{eq}}$  Using the BIR/PEC Accounting Method

Appendix 4.4: Equilibrium Problems

**Selecting Learning Resources**

For additional information on selecting learning resources for Grade 11 and Grade 12 Chemistry, see the Manitoba Education website at <[www.edu.gov.mb.ca/k12/learnres/bibliographies.html](http://www.edu.gov.mb.ca/k12/learnres/bibliographies.html)>.

**SKILLS AND ATTITUDES OUTCOME**

**C12-0-U1:** Use appropriate strategies and skills to develop an understanding of chemical concepts.

*Examples: analogies, concept frames, concept maps, manipulatives, particulate representations, role-plays, simulations, sort-and-predict frames, word cycles . . .*

---

**NOTES**

**Topic 4:  
Chemical  
Equilibrium**

**SPECIFIC LEARNING OUTCOME**

**C12-4-05:** Perform a laboratory activity to determine the equilibrium constant of an equilibrium system.

(1.5 hours)

SLO: C12-4-05

**SUGGESTIONS FOR INSTRUCTION**

**Entry-Level Knowledge**

In addressing specific learning outcome C12-4-04, students solved problems involving equilibrium constants. They will now have an opportunity to use experimental data to calculate the value of  $K_{\text{eq}}$  for a reversible reaction.

**TEACHER NOTES**

It is not intended that students perform all the lab activities suggested below (and in the Learning Resources Links). Select a lab activity appropriate for students' skill level and the equipment available at the school.

**Laboratory Activities: Investigating Chemical Equilibrium**

Have students perform lab activities, such as the following, to determine the equilibrium constant of an equilibrium system.

■ **Lab 16: Exploring Chemical Equilibrium** (Dingrando, et al. 61)

In this experiment, students calculate  $K_{\text{eq}}$  for a reaction between  $\text{Fe}^{3+}$  and  $\text{SCN}^-$ . They investigate the reaction in which colourless  $\text{Fe}^{3+}$  and  $\text{SCN}^-$  ions combine to form a red  $\text{FeSCN}^{2+}$  ion. They prepare serial dilutions of  $\text{Fe}(\text{NO}_3)_2$  and estimate the colour intensity of solutions at equilibrium. Students then relate colour-intensity values to the concentration of  $\text{FeSCN}^{2+}$  at equilibrium.

**General Learning Outcome Connections**

- GLO B3:** Identify the factors that affect health, and explain the relationships among personal habits, lifestyle choices, and human health, both individual and social.
- GLO B5:** Identify and demonstrate actions that promote a sustainable environment, society, and economy, both locally and globally.
- GLO C1:** Recognize safety symbols and practices related to scientific and technological activities and to their daily lives, and apply this knowledge in appropriate situations.
- GLO C2:** Demonstrate appropriate scientific inquiry skills when seeking answers to questions.
- GLO C5:** Demonstrate curiosity, skepticism, creativity, open-mindedness, accuracy, precision, honesty, and persistence, and appreciate their importance as scientific and technological habits of mind.

**SKILLS AND ATTITUDES OUTCOMES**

- C12-0-S1:** Demonstrate work habits that ensure personal safety and the safety of others, as well as consideration for the environment.  
Include: knowledge and use of relevant safety precautions, Workplace Hazardous Materials Information System (WHMIS), and emergency equipment
- C12-0-S6:** Estimate and measure accurately using Système International (SI) and other standard units.  
Include: SI conversions and significant figures
- C12-0-S7:** Interpret patterns and trends in data, and infer and explain relationships.
- C12-0-S8:** Evaluate data and data-collection methods for accuracy and precision.  
Include: discrepancies in data, sources of error, and percent error
- 

■ **Investigation 16.C: Using Experimental Data to Determine an Equilibrium Constant** (Chastko, et al. 662).

This investigation studies the equilibrium between iron(III) ions, thiocyanate ions, and iron(III) thiocyanate ions. Four different equilibrium mixtures with different initial concentrations of  $\text{Fe}^{2+}_{(\text{aq})}$  and  $\text{SCN}^{-}_{(\text{aq})}$  are prepared. The initial concentrations of these ions are calculated from the volumes and concentrations of the stock solution used and the total volumes of the equilibrium mixtures. The concentration of  $\text{Fe}(\text{SCN})^{2+}_{(\text{aq})}$  in each mixture is determined by comparing the colour intensity of the mixture with the colour intensity of a solution with known concentration. The concentrations of  $\text{Fe}^{2+}_{(\text{aq})}$  and  $\text{SCN}^{-}_{(\text{aq})}$  are calculated from the known concentration of  $\text{Fe}(\text{SCN})^{2+}_{(\text{aq})}$ . Then these values are substituted into the equilibrium expression to solve for  $K_{\text{eq}}$ .

■ **Investigation 13-A: Measuring an Equilibrium Constant** (Mustoe, et al. 501).

This investigation is very similar to Investigation 16.C: Using Experimental Data to Determine an Equilibrium Constant.

■ **Lab Exercise 7.2.1: Develop an Equilibrium Law** (van Kessel, et al. 514).

Have students use experimental data and apply mathematical relationships to see which gives a constant value.

■ **Using a Colorimeter or Spectrometer**

Have students perform the experiment outlined in Appendix 4.5: Chemical Equilibrium: Lab Activity. In this experiment, students add together varying concentrations of  $\text{SCN}^{-}$  and  $\text{Fe}^{3+}$  to achieve an equilibrium system between the two ions and the  $\text{FeSCN}^{2+}$  ion. Students should note that the higher the concentration of the  $\text{Fe}^{3+}$  is, the darker the orange-red colour of the complex will be. They then use spectrometers or colorimeters to determine the optical density (absorbance) of each system, and then use the information to determine the equilibrium concentrations of all reactants and products in order to solve for the value of  $K_{\text{eq}}$ .

Also refer to “Chemical Equilibrium: Finding a Constant,  $K_c$ ” (Holmquist, Randall, and Volz, *Chemistry with CBL* 20-1 to 20-2GT).

**Topic 4:  
Chemical  
Equilibrium****SPECIFIC LEARNING OUTCOME**

**C12-4-05:** Perform a laboratory activity to determine the equilibrium constant of an equilibrium system.

(continued)

**SUGGESTIONS FOR ASSESSMENT****Laboratory Reports**

Students can use the Laboratory Report Format to write their lab reports (see *SYSTH* 14.12). Word processing and spreadsheet software could be used to prepare reports. Also refer to the Lab Report Assessment rubric in Appendix 11.

**Laboratory Skills**

Periodically and randomly review the lab skills of individual students, so that eventually all students are assessed. Pay particular attention to skills related to serial dilutions from stock solutions. Sample checklists for assessing lab skills and work habits are available in *SYSTH* (6.10, 6.11).

**LEARNING RESOURCES LINKS**

*McGraw-Hill Ryerson Chemistry, Combined Atlantic Edition* (Mustoe, et al. 501)

*McGraw-Hill Ryerson Inquiry into Chemistry* (Chastko, et al. 662)

*Nelson Chemistry 12, Ontario Edition* (van Kessel, et al. 514)

**Investigations**

*Chemistry with CBL* (Holmquist, Randall, and Volz).

Chemical Equilibrium: Finding a Constant,  $K_c$ , 20-1 to 20-2T

*Glencoe Chemistry: Matter and Change: Small-Scale Laboratory Manual, Teacher Edition* (Dingrando et al.)

Lab 16: Exploring Chemical Equilibrium, 61

*McGraw-Hill Ryerson Chemistry, Combined Atlantic Edition* (Mustoe, et al.)

Investigation 13-A: Measuring an Equilibrium Constant, 501

*McGraw-Hill Ryerson Inquiry into Chemistry* (Chastko, et al.)

Investigation 16.C: Using Experimental Data to Determine an Equilibrium Constant, 662

*Nelson Chemistry 12, Ontario Edition* (van Kessel, et al.)

Lab Exercise 7.2.1: Develop an Equilibrium Law, 514

**Appendix**

Appendix 4.5: Chemical Equilibrium: Lab Activity

**SKILLS AND ATTITUDES OUTCOMES**

**C12-0-S1:** Demonstrate work habits that ensure personal safety and the safety of others, as well as consideration for the environment.

Include: knowledge and use of relevant safety precautions, Workplace Hazardous Materials Information System (WHMIS), and emergency equipment

**C12-0-S6:** Estimate and measure accurately using Système International (SI) and other standard units.

Include: SI conversions and significant figures

**C12-0-S7:** Interpret patterns and trends in data, and infer and explain relationships.

**C12-0-S8:** Evaluate data and data-collection methods for accuracy and precision.

Include: discrepancies in data, sources of error, and percent error

---

**Selecting Learning Resources**

For additional information on selecting learning resources for Grade 11 and Grade 12 Chemistry, see the Manitoba Education website at <[www.edu.gov.mb.ca/k12/learnres/bibliographies.html](http://www.edu.gov.mb.ca/k12/learnres/bibliographies.html)>.

## Topic 4: Chemical Equilibrium

### SPECIFIC LEARNING OUTCOMES

**C12-4-06:** Use Le Châtelier's principle to predict and explain shifts in equilibrium.

Include: temperature changes, pressure/volume changes, changes in reactant/product concentrations, the addition of a catalyst, the addition of an inert gas, and the effects of the various stresses on the equilibrium constant

**C12-4-07:** Perform a laboratory activity to demonstrate Le Châtelier's principle.

(3.5 hours)

SLO: C12-4-06  
SLO: C12-4-07

### SUGGESTIONS FOR INSTRUCTION

#### Entry-Level Knowledge

In Grade 11 Chemistry (C11-02-05), students performed an experiment to discover Boyle's law, which states that pressure and volume are inversely proportional to one another. In both Grades 11 and 12 Chemistry (C11-3-13, C12-3-04), students have worked with endothermic and exothermic reactions. Students performed a lab activity (C12-3-02) to observe the effects of concentration, temperature, pressure, volume, and the presence of a catalyst on the rate of a reaction.

#### Assessing Prior Knowledge

Check for students' prior knowledge, and review concepts as necessary.

### TEACHER NOTES

#### Le Châtelier's Principle

In 1884, French chemist Henri Louis Le Châtelier proposed the *law of mobile equilibrium* (commonly referred to as *Le Châtelier's principle*), which states that if a stress is placed on a reversible reaction at chemical equilibrium, the equilibrium will shift to relieve the stress, thereby restoring equilibrium. Le Châtelier's principle describes how a chemical equilibrium shifts in response to a stress or disturbance within an enclosed system, as described in the following table.

### General Learning Outcome Connections

- GLO C2: Demonstrate appropriate scientific inquiry skills when seeking answers to questions.
- GLO C3: Demonstrate appropriate problem-solving skills when seeking solutions to technological challenges.
- GLO C4: Demonstrate appropriate critical thinking and decision-making skills when choosing a course of action based on scientific and technological information.
- GLO C5: Demonstrate curiosity, skepticism, creativity, open-mindedness, accuracy, precision, honesty, and persistence, and appreciate their importance as scientific and technological habits of mind.
- GLO C8: Evaluate, from a scientific perspective, information and ideas encountered during investigations in daily life.



**SKILLS AND ATTITUDES OUTCOMES**

**C12-0-S2:** State a testable hypothesis or prediction based on background data or on observed events.

**C12-0-S5:** Collect, record, organize, and display data using an appropriate format.

*Examples: labelled diagrams, graphs, multimedia applications, software integration, probeware . . .*

**C12-0-S9:** Draw a conclusion based on the analysis and interpretation of data.

Include: cause-and-effect relationships, alternative explanations, and supporting or rejecting a hypothesis or prediction

**C12-0-A2:** Value skepticism, honesty, accuracy, precision, perseverance, and open-mindedness as scientific and technological habits of mind.

<b>Shifts in Equilibrium in Response to Stress</b>		
<b>Stress</b>	<b>System Response</b>	<b>Effect on the Equilibrium Constant</b>
<b>Increase in temperature</b>	The system shifts to use up the added heat, favouring the endothermic reaction.	The equilibrium constant changes because the equilibrium position shifts without any substances being added or removed. There is no heat-related term in the mass action expression to maintain the ratio.
<b>Decrease in temperature</b>	The system shifts to produce more heat, favouring the exothermic reaction.	It changes because the equilibrium position shifts without any substances being added or removed. There is no heat-related term in the mass action expression to maintain the ratio.
<b>Increase in volume (decrease in pressure)</b>	The system shifts to the side with the most gas particles because solids and liquids are incompressible.	It does not change because all reactant and product concentrations change, resulting in the same ratio.
<b>Decrease in volume (increase in pressure)</b>	The system shifts to the side with the fewest gas particles because solids and liquids are incompressible.	It does not change because all reactant and product concentrations change, resulting in the same ratio.
<b>Increase in concentration</b>	The system shifts to decrease the reactant or product that was added.	It does not change because all reactant and product concentrations change, resulting in the same ratio.
<b>Decrease in concentration</b>	The system shifts to increase the reactant or product that was removed.	It does not change because all reactant and product concentrations change, resulting in the same ratio.
<b>Addition of a catalyst</b>	No change in the system occurs. Catalysts increase the forward and reverse reactions to the same extent, so that they only serve to help bring systems to equilibrium faster.	It does not change.
<b>Addition of an inert gas</b>	No change in the system occurs because it does not take part in the reaction.	It does not change.

## Topic 4: Chemical Equilibrium

### SPECIFIC LEARNING OUTCOMES

**C12-4-06:** Use Le Châtelier's principle to predict and explain shifts in equilibrium.

Include: temperature changes, pressure/volume changes, changes in reactant/product concentrations, the addition of a catalyst, the addition of an inert gas, and the effects of the various stresses on the equilibrium constant

**C12-4-07:** Perform a laboratory activity to demonstrate Le Châtelier's principle.

(continued)

The following shows how a change in concentration affects the other substances in a chemical reaction (Silberberg 746).

These concentration changes cause a shift to the right:

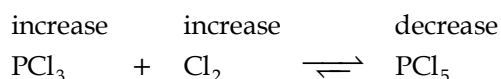

These concentration changes cause a shift to the left:

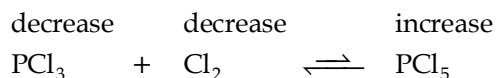

### Demonstrations

#### ■ Traffic Light Reaction

This demonstration shows an oscillating colour reaction starting with yellow-orange, changing to red (after shaking the flask once), and then to green (after shaking the flask again). After the flask stands for awhile, the colour returns to red and then back to yellow-orange. The idea behind this demonstration is that shaking is enough for the first reaction to occur, and then a few more shakes gets the second reaction going. As the solution settles, the kinetic energy (from shaking) drops, and the reactions do not have enough energy to continue.

To prepare for the demonstration, dissolve 32 g of potassium hydroxide in 1200 mL water (solution A), 40 g of glucose in 1200 mL water (solution B), 0.50 g of benzoin in 500 mL water (solution C), and 1.0 g of indigo carmine in 200 mL water (solution D). To a clean, empty flask, add 200 mL of solution A, then 200 mL of B, then 60 mL of C, and then 16 mL of D.

Similar demonstrations can be viewed online.

*Sample Websites:*

Keusch, Peter. "Belousov-Zhabotinsky Reaction." *Organic Chemistry Demonstration Experiments on Video: Chemistry Visualized*. University of Regensburg. <[www.uni-regensburg.de/Fakultaeten/nat\\_Fak\\_IV/Organische\\_Chemie/Didaktik/Keusch/D-oscill-e.htm](http://www.uni-regensburg.de/Fakultaeten/nat_Fak_IV/Organische_Chemie/Didaktik/Keusch/D-oscill-e.htm)> (22 Feb. 2012).

In this video demonstration, the colour oscillates between red and blue.

**SKILLS AND ATTITUDES OUTCOMES**

- C12-0-S2:** State a testable hypothesis or prediction based on background data or on observed events.
- C12-0-S5:** Collect, record, organize, and display data using an appropriate format.  
*Examples: labelled diagrams, graphs, multimedia applications, software integration, probeware . . .*
- C12-0-S9:** Draw a conclusion based on the analysis and interpretation of data.  
Include: cause-and-effect relationships, alternative explanations, and supporting or rejecting a hypothesis or prediction
- C12-0-A2:** Value skepticism, honesty, accuracy, precision, perseverance, and open-mindedness as scientific and technological habits of mind.

Wyatt, Shawn. "Go-Science Traffic Light Reaction Chemistry Demonstration." *World News*. <[http://wn.com/Traffic\\_Light\\_Reaction\\_GO-Science\\_Demonstration](http://wn.com/Traffic_Light_Reaction_GO-Science_Demonstration)> (22 Feb. 2012).

- **Liquid Crystal Demonstration**

If a sheet of temperature-sensitive liquid crystal is available, wrap the sheet around glasses of cold water, water at room temperature, and hot water to see that warmer temperatures yield darker colours:

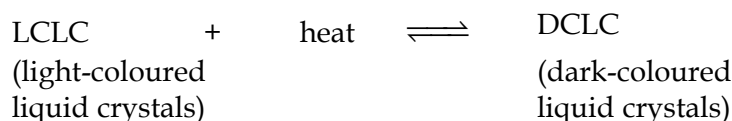

Mood rings, made of liquid crystals, take advantage of this phenomenon by re-equilibrating as a result of slight changes in body temperature.

- **Laboratory Activities: Disturbing Equilibrium Systems**

Any of the following experiments can be performed to determine how equilibrium systems respond to stresses. It is not intended that students perform all the suggested lab activities. Select lab activities appropriate for the abilities of students in the class and the equipment available at the school.

- **Analogy for an Equilibrium Reaction**

The procedure for this investigation can be found in Appendix 4.6A: An Analogy for an Equilibrium Reaction: Lab Activity. Students use straws of two different diameters to transfer water between two graduated cylinders until equilibrium is achieved. This lab activity demonstrates that systems are not necessarily at equilibrium when the concentrations of reactants and products are identical. Students' results will vary, depending upon the size of straw they place into each graduated cylinder. A lab report checklist for this experiment is given in Appendix 4.6C. Teacher notes are provided in Appendix 4.6B.

## Topic 4: Chemical Equilibrium

### SPECIFIC LEARNING OUTCOMES

**C12-4-06:** Use Le Châtelier's principle to predict and explain shifts in equilibrium.

Include: temperature changes, pressure/volume changes, changes in reactant/product concentrations, the addition of a catalyst, the addition of an inert gas, and the effects of the various stresses on the equilibrium constant

**C12-4-07:** Perform a laboratory activity to demonstrate Le Châtelier's principle.

(continued)

#### ■ Qualitative Equilibrium

The pre-lab exercise provided in Appendix 4.7: Equilibrium and Le Châtelier's Principle (Pre-lab) gives students an opportunity to predict the direction in which the equilibrium will shift with the given stresses. A complete student procedure for this lab activity can be found in Appendix 4.8A: Qualitative Equilibrium: Lab Activity. (See Appendix 4.8B for teacher notes.) Students create an equilibrium system using 0.02 mol/L iron(III) nitrate and 0.002 mol/L potassium thiocyanate. The solutions are mixed, and then "stressed" by adding iron(III) nitrate, solid potassium thiocyanate, and sodium hydrogen phosphate to samples of the solution. Shifts in the original equilibrium position may be seen through colour changes.

#### ■ Disrupting Equilibrium Systems

The procedure for this lab activity can be found in Appendix 4.9: Disrupting Equilibrium Systems: Lab Activity. The reaction that students study is

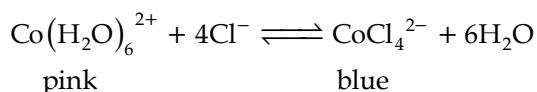

Students dissolve cobalt chloride in ethanol and record the colour of the solution. They add stresses to samples of this prepared solution (distilled water, hydrochloric acid, solid calcium chloride, silver nitrate solution, addition of heat, and removal of heat) and note the resulting colours.

#### ■ MiniLAB 18: Shifts in Equilibrium (Dingrando, et al., *Glencoe Chemistry: Matter and Change* 573)

In this experiment, students observe an equilibrium shift in a colourful way. Students add hydrochloric acid to a 0.1 mol/L solution of cobalt chloride. The pink colour changes to a purple colour. To this solution, students then add water, and the colour returns to pink. Then students place a sample of the cobalt chloride-hydrochloric acid solution in hot water, which results in a blue colour being produced. When they place a sample of the cobalt chloride-hydrochloric acid solution in cold water, the pink colour appears.

**SKILLS AND ATTITUDES OUTCOMES**

- C12-0-S2:** State a testable hypothesis or prediction based on background data or on observed events.
- C12-0-S5:** Collect, record, organize, and display data using an appropriate format.  
*Examples: labelled diagrams, graphs, multimedia applications, software integration, probeware . . .*
- C12-0-S9:** Draw a conclusion based on the analysis and interpretation of data.  
Include: cause-and-effect relationships, alternative explanations, and supporting or rejecting a hypothesis or prediction
- C12-0-A2:** Value skepticism, honesty, accuracy, precision, perseverance, and open-mindedness as scientific and technological habits of mind.
- 

- **Lab 15: Observing Equilibrium** (Dingrando, et al., *Glencoe Chemistry: Matter and Change: Small-Scale Laboratory Manual, Teacher Edition* 57)

In the first part of the lab activity, students record the colours of  $\text{Fe}^{3+}$  ion,  $\text{SCN}^-$  ion, and  $\text{FeSCN}^{2+}$  ion. The direction of shift in equilibrium is measured by the colour change that occurs, which is related to the concentration of reactant. Students pour a dilute solution of iron(III) nitrate and potassium thiocyanate into five separate test tubes. To the first test tube, 0.5 g of  $\text{Fe}(\text{NO}_3)_3$  is added to the solution, and a darker red colour is observed. To the second test tube, 0.5 g  $\text{NH}_4\text{SCN}$  is added to the solution, and a dark red colour results. To the third test tube, 0.5 g  $\text{KCl}$  is added to the solution, and a light red colour (or orange colour) is observed. To the fourth test tube, a few millilitres of sodium hydroxide solution is added to the original solution, which results in a colourless solution with a white precipitate. To the fifth test tube, a few millilitres of silver nitrate are added, which results in a colourless solution and a white precipitate.

- **Experiment 29: Le Châtelier's Principle and Chemical Equilibrium** (Waterman and Thompson, *Prentice Hall Chemistry: Small-Scale Chemistry Laboratory Manual* 203)

In this experiment, students “observe and record how a chemical system at equilibrium responds to changes in concentration of reactants or products” (203). They describe these shifts in equilibrium in terms of Le Châtelier's principle. As this is a small-scale lab activity, the quantities required of the following solutions are minimal: bromthymol blue, hydrochloric acid, sodium hydroxide, ammonia, copper(II) sulphate, lead(II) nitrate, potassium iodide, nitric acid, silver nitrate, sodium carbonate, sodium thiosulphate, and sodium phosphate.

- **Investigation 16A: Modelling Equilibrium** (Chastko, et al. 635)

This investigation is similar to the one outlined in Appendix 4.6A: An Analogy for an Equilibrium Reaction. Using two glass tubes of different diameters, students transfer water from one graduated cylinder to another, and vice versa. In the reactant cylinder, 25 mL of water is present. In the product cylinder, there is no water present initially.

**Topic 4:  
Chemical  
Equilibrium**

---

**SPECIFIC LEARNING OUTCOMES**

**C12-4-06:** Use Le Châtelier's principle to predict and explain shifts in equilibrium.

Include: temperature changes, pressure/volume changes, changes in reactant/product concentrations, the addition of a catalyst, the addition of an inert gas, and the effects of the various stresses on the equilibrium constant

**C12-4-07:** Perform a laboratory activity to demonstrate Le Châtelier's principle.

(continued)

---

■ **ExpressLab: Modelling Equilibrium** (Mustoe, et al 491)

This lab activity is the same as Investigation 16.A: Modelling Equilibrium (Chastko, et al. 635).

■ **Investigation 16.B: Disturbing Equilibrium** (Chastko, et al. 652)

In this three-part investigation, students use Le Châtelier's principle to predict the effect of change on a system at equilibrium. They design an experiment to illustrate and test their prediction by assessing a change of colour or the appearance (or disappearance) of a precipitate. In Part 1, students explore changes to a base equilibrium system. In Part 2, they examine concentration and temperature changes. In Part 3, the teacher performs a demonstration to investigate gaseous equilibria.

■ **Investigation 13-B: Perturbing Equilibrium** (Mustoe, et al 521)

This lab activity is essentially the same as Investigation 16.B: Disturbing Equilibrium (Chastko, et al. 652), except students use different chemicals. Students use Le Châtelier's principle to predict and test the effect of changing one factor in systems at equilibrium. Students complete the first three parts of the investigation, and the teacher demonstrates the last part, dealing with gaseous equilibria.

■ **Investigation 7.3.1: Testing Le Châtelier's Principle** (van Kessel, et al 514)

In this seven-part lab activity, stresses are applied to different chemical equilibrium systems to test Le Châtelier's principle. The lab activity includes an investigation of increasing pressure on a carbon dioxide-bicarbonate mixture.

**Whole-Class Learning Activity: Reaction Tendencies**

Have students view "Reaction Tendencies," episode 4 of *Chemical Equilibrium* (TVOntario). This episode shows the effects of heat and pressure on an equilibrium system using Le Châtelier's principle. Students can describe these effects on an equilibrium system on both a macroscopic level and a microscopic level.

**SKILLS AND ATTITUDES OUTCOMES**

**C12-0-S2:** State a testable hypothesis or prediction based on background data or on observed events.

**C12-0-S5:** Collect, record, organize, and display data using an appropriate format.

*Examples: labelled diagrams, graphs, multimedia applications, software integration, probeware . . .*

**C12-0-S9:** Draw a conclusion based on the analysis and interpretation of data.

Include: cause-and-effect relationships, alternative explanations, and supporting or rejecting a hypothesis or prediction

**C12-0-A2:** Value skepticism, honesty, accuracy, precision, perseverance, and open-mindedness as scientific and technological habits of mind.

---

**Online Demonstrations**

Have students view online demonstrations of Le Châtelier's principle.

*Sample Website:*

The North Carolina School of Science and Mathematics (NCSSM). "Chapter 14: Gas Phase, Solubility, Complex Ion Equilibria." *Chemistry Online Resource Essentials (CORE)*. <[www.dlt.ncssm.edu/core/c14.htm](http://www.dlt.ncssm.edu/core/c14.htm)> (13 Jan. 2012).

This website provides a variety of video clips that demonstrate shifts in equilibrium using Le Châtelier's principle:

- *FeSCN<sup>2+</sup> Equilibrium – Le Châtelier's Principle Lab, Part 1* shows the effect of adding stresses to the equilibrium  $\text{FeSCN}^{2+} - \text{Fe}(\text{SCN})^{+2}$ .
- *Cobalt Complex Ion Equilibrium – Le Châtelier's Principle Lab, Part 3* demonstrates the cobalt chloride complex (pink to blue) equilibrium.
- *NO<sub>2</sub>-N<sub>2</sub>O<sub>4</sub> Gas Equilibrium – Le Châtelier's Principle Lab, Part 4* shows the effect of temperature on the equilibrium  $\text{NO}_2 - \text{N}_2\text{O}_4$ . As temperature is decreased, there is an increase in  $\text{N}_2\text{O}_4$  (colourless).

**SUGGESTIONS FOR ASSESSMENT**

---

**Paper-and-Pencil Tasks**

1. To begin addressing learning outcomes C12-4-06 and C12-4-07 and to review prior knowledge, have students answer the following questions:
  - What are the five factors that affect reaction rate?
  - How do the rates of the forward and reverse reactions compare for a reaction at equilibrium?

## Topic 4: Chemical Equilibrium

### SPECIFIC LEARNING OUTCOMES

**C12-4-06:** Use Le Châtelier's principle to predict and explain shifts in equilibrium.

Include: temperature changes, pressure/volume changes, changes in reactant/product concentrations, the addition of a catalyst, the addition of an inert gas, and the effects of the various stresses on the equilibrium constant

**C12-4-07:** Perform a laboratory activity to demonstrate Le Châtelier's principle.

(continued)

2. Have students answer questions related to Le Châtelier's principle.

*Example:*

Much of the brown haze hanging over large cities is nitrogen dioxide ( $\text{NO}_{2(g)}$ ). Nitrogen dioxide reacts to form dinitrogen tetraoxide ( $\text{N}_2\text{O}_{4(g)}$ ), according to the equation

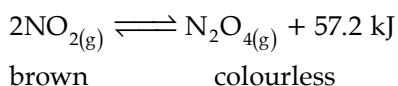

Use this equilibrium to explain why the brownish haze over a large city disappears in the winter, only to reappear again in the spring.

*Answer:*

The stress is a decrease in temperature in the winter. The exothermic reaction (a release of heat) would be favoured to oppose the decrease in temperature. This would favour the production of the colourless dinitrogen tetraoxide gas. In the summer, the stress would be an increase in temperature. The endothermic reaction (absorption of heat) would be favoured to oppose this stress. Nitrogen dioxide would, therefore, be produced, and we would see a brown haze over the city.

### Journal Writing

Students can write a fictionalized newspaper article written on the day after Henri Louis Le Châtelier's principle was announced in 1884. Students' articles should highlight this scientific contribution.

### Laboratory Reports

Students can use the Lab Report Format to write their lab reports (see *SYSTH* 14.12). Word processing and spreadsheet software could be used to prepare reports. Also refer to the Lab Report Assessment rubric in Appendix 11.

### Laboratory Skills

Periodically and randomly review the lab skills of individual students, so that eventually all students are assessed. For sample checklists, refer to *SYSTH* (6.10, 6.11).



**SKILLS AND ATTITUDES OUTCOMES**

- C12-0-S2:** State a testable hypothesis or prediction based on background data or on observed events.
- C12-0-S5:** Collect, record, organize, and display data using an appropriate format.  
*Examples: labelled diagrams, graphs, multimedia applications, software integration, probeware . . .*
- C12-0-S9:** Draw a conclusion based on the analysis and interpretation of data.  
Include: cause-and-effect relationships, alternative explanations, and supporting or rejecting a hypothesis or prediction
- C12-0-A2:** Value skepticism, honesty, accuracy, precision, perseverance, and open-mindedness as scientific and technological habits of mind.

**LEARNING RESOURCES LINKS**

- Chemistry* (Chang 607)
- Chemistry* (Zumdahl and Zumdahl 640)
- Chemistry: The Molecular Nature of Matter and Change* (Silberberg 745)
- Glencoe Chemistry: Concepts and Applications* (Phillips, Strozak, and Wistrom 214)
- Glencoe Chemistry: Matter and Change* (Dingrando, et al. 569)
- McGraw-Hill Ryerson Chemistry, Combined Atlantic Edition* (Mustoe, et al. 519)
- McGraw-Hill Ryerson Inquiry into Chemistry* (Chastko, et al. 646)
- Nelson Chemistry 12, Ontario Edition* (van Kessel, et al. 450)
- Prentice Hall Chemistry* (Wilbraham, et al. 552)

**Investigations**

- Glencoe Chemistry: Matter and Change* (Dingrando, et al.)  
MiniLab 18: Shifts in Equilibrium, 573
- Glencoe Chemistry: Matter and Change: Small-Scale Laboratory Manual, Teacher's Edition* (Dingrando, et al.)  
Lab 15: Observing Equilibrium, 57
- McGraw-Hill Ryerson Chemistry, Combined Atlantic Edition* (Mustoe, et al.)  
ExpressLab: Modelling Equilibrium, 491  
Investigation 13-B: Perturbing Equilibrium, 521
- McGraw-Hill Ryerson Inquiry into Chemistry* (Chastko, et al.)  
Investigation 16.A: Modelling Equilibrium, 635  
Investigation 16.B: Disturbing Equilibrium, 652
- Nelson Chemistry 12, Ontario Edition* (van Kessel, et al.)  
Investigation 7.3.1: Testing Le Châtelier's Principle, 514
- Prentice Hall Chemistry: Small-Scale Chemistry Laboratory Manual* (Waterman and Thompson)  
Experiment 29: Le Châtelier's Principle and Chemical Equilibrium, 203

**Video**

- "Reaction Tendencies." *Chemical Equilibrium*. Concepts in Science series.  
TVOntario. Toronto, ON. 1984. (60 min)

**Topic 4:  
Chemical  
Equilibrium****SPECIFIC LEARNING OUTCOMES**

**C12-4-06:** Use Le Châtelier's principle to predict and explain shifts in equilibrium.

Include: temperature changes, pressure/volume changes, changes in reactant/product concentrations, the addition of a catalyst, the addition of an inert gas, and the effects of the various stresses on the equilibrium constant

**C12-4-07:** Perform a laboratory activity to demonstrate Le Châtelier's principle.

(continued)

**Websites**

Keusch, Peter. "Belousov-Zhabotinsky Reaction." *Organic Chemistry Demonstration Experiments on Video: Chemistry Visualized*. University of Regensburg. <[www.uni-regensburg.de/Fakultaeten/nat\\_Fak\\_IV/Organische\\_Chemie/Didaktik/Keusch/D-oscill-e.htm](http://www.uni-regensburg.de/Fakultaeten/nat_Fak_IV/Organische_Chemie/Didaktik/Keusch/D-oscill-e.htm)> (22 Feb. 2012).

The North Carolina School of Science and Mathematics (NCSSM). "Chapter 14: Gas Phase, Solubility, Complex Ion Equilibria." *Chemistry Online Resource Essentials (CORE)*. <[www.dlt.ncssm.edu/core/c14.htm](http://www.dlt.ncssm.edu/core/c14.htm)> (13 Jan. 2012).

Wyatt, Shawn. "Go-Science Traffic Light Reaction Chemistry Demonstration." *World News*. <[http://wn.com/Traffic\\_Light\\_Reaction\\_GO-Science\\_Demonstration](http://wn.com/Traffic_Light_Reaction_GO-Science_Demonstration)> (22 Feb. 2012).

**Appendices**

Appendix 4.6A: An Analogy for an Equilibrium Reaction: Lab Activity

Appendix 4.6B: An Analogy for an Equilibrium Reaction: Lab Activity (Teacher Notes)

Appendix 4.6C: An Analogy for an Equilibrium Reaction: Lab Report Checklist

Appendix 4.7: Equilibrium and Le Châtelier's Principle (Pre-lab)

Appendix 4.8A: Qualitative Equilibrium: Lab Activity

Appendix 4.8B: Qualitative Equilibrium: Lab Activity (Teacher Notes)

Appendix 4.9: Disrupting Equilibrium Systems: Lab Activity

**Selecting Learning Resources**

For additional information on selecting learning resources for Grade 11 and Grade 12 Chemistry, see the Manitoba Education website at <[www.edu.gov.mb.ca/k12/learnres/bibliographies.html](http://www.edu.gov.mb.ca/k12/learnres/bibliographies.html)>.

**SKILLS AND ATTITUDES OUTCOMES**

**C12-0-S2:** State a testable hypothesis or prediction based on background data or on observed events.

**C12-0-S5:** Collect, record, organize, and display data using an appropriate format.

*Examples: labelled diagrams, graphs, multimedia applications, software integration, probeware . . .*

**C12-0-S9:** Draw a conclusion based on the analysis and interpretation of data.

Include: cause-and-effect relationships, alternative explanations, and supporting or rejecting a hypothesis or prediction

**C12-0-A2:** Value skepticism, honesty, accuracy, precision, perseverance, and open-mindedness as scientific and technological habits of mind.

---

**NOTES**

**Topic 4:  
Chemical  
Equilibrium**

**SPECIFIC LEARNING OUTCOME**

**C12-4-08:** Interpret concentration versus time graphs.

Include: temperature changes, concentration changes, and the addition of a catalyst

(1 hour)

SLO: C12-4-08

**SUGGESTIONS FOR INSTRUCTION**

**Entry-Level Knowledge**

In learning outcome C12-4-01, students were introduced to a qualitative treatment of concentration versus time graphs.

In learning outcome C12-4-06, students saw that a system at equilibrium will shift to minimize a stress and re-establish equilibrium.

**TEACHER NOTES**

Ask students to recall that equilibrium is shown by a plateau on a concentration versus time graph. If students completed the analogy lab activity in addressing learning outcomes C12-4-06 and C12-4-07, ask them to refer to their results. See Appendix 4.6A: An Analogy for an Equilibrium Reaction: Lab Activity. The plateau in such concentration versus time graphs demonstrates that the concentrations of reactants and products are not changing over time.

**Concentration versus Time Graphs: Class Activity**

Work through the following sample problem with students to introduce the quantitative analysis of concentration versus time graphs. See the teacher support material in Appendix 4.10: Interpreting Equilibrium Graphs and Appendix 4.11: Interpreting Concentration versus Time Graphs.

Alternatively, provide students with graphical data, such as the following, so that they can generate a graph before its interpretation.

**General Learning Outcome Connections**

**GLO C2:** Demonstrate appropriate scientific inquiry skills when seeking answers to questions.

**GLO C5:** Demonstrate curiosity, skepticism, creativity, open-mindedness, accuracy, precision, honesty, and persistence, and appreciate their importance as scientific and technological habits of mind.

## SKILLS AND ATTITUDES OUTCOME

C12-0-S7: Interpret patterns and trends in data, and infer and explain relationships.

Data Table

Time	[FeSCN <sup>2+</sup> ]	[SCN <sup>-</sup> ]	[Fe <sup>3+</sup> ]	[Fe <sup>3+</sup> ] (after stress)
0	0	2.5	4	
5	1	1.75	3.25	
10	1	1.5	3	
11	1	1.5	3	
12	1	1.5	3	
13	1	1.5	3	
14	1	1.5	3	7
15	1	1.5		6
20	1.5	1.25		5
25	1.5	1.25		5
30	1.5	1.25		5

Concentration versus Time

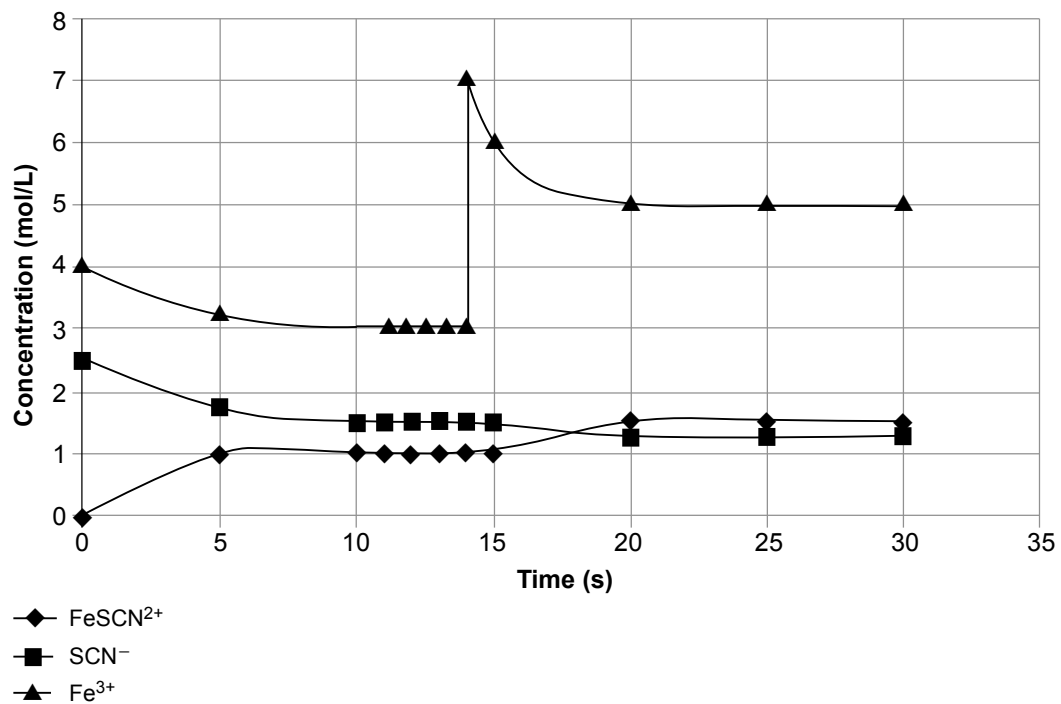

**Topic 4:**  
**Chemical**  
**Equilibrium**

## SPECIFIC LEARNING OUTCOME

C12-4-08: Interpret concentration versus time graphs.

Include: temperature changes, concentration changes, and the addition of a catalyst

(continued)

**Sample Problem: Interpretation of Concentration versus Time Graph**

For the reaction,  $\text{Fe}^{3+} + \text{SCN}^- \rightleftharpoons \text{FeSCN}^{2+}$ , the concentrations of the reactants ( $\text{Fe}^{3+}$  and  $\text{SCN}^-$ ) are decreasing as the reaction proceeds and the concentration of the product ( $\text{FeSCN}^{2+}$ ) is increasing. It appears that the reaction reaches equilibrium at 10 seconds. At 14 seconds, a stress is added to the equilibrium, as the concentration of  $\text{Fe}^{3+}$  spikes dramatically upward at that point. There are more molecules of  $\text{Fe}^{3+}$  in the system, so the number of molecules of  $\text{SCN}^-$  decreases, and more product ( $\text{FeSCN}^{2+}$ ) is produced. A new equilibrium is established at 20 seconds.

*Questions:*

1. Write a balanced equation to represent the reaction.
2. How much time was required for the system to reach equilibrium?
3. Calculate the approximate value of the equilibrium constant from the concentrations at 10 seconds.
4. Calculate the approximate value of the equilibrium constant from the concentrations at 20 seconds.
5. How do the two values from questions 3 and 4 compare? Explain.
6. What stress occurred at 14 seconds?
7. How would the addition of a positive catalyst change the shape of this graph?

*Answers:*

1.  $\text{Fe}^{3+} + \text{SCN}^- \rightleftharpoons \text{FeSCN}^{2+}$
2. The system reached equilibrium in 10 seconds.
3. 
$$K_{\text{eq}} = \frac{[\text{FeSCN}^{2+}]}{[\text{Fe}^{3+}][\text{SCN}^-]} = \frac{(1)}{(3)(1.5)} = 0.22$$
4. 
$$K_{\text{eq}} = \frac{[\text{FeSCN}^{2+}]}{[\text{Fe}^{3+}][\text{SCN}^-]} = \frac{(1.5)}{(5)(1.25)} = 0.24$$
5. The two values are approximately the same because the stress imposed on the system was not a change in temperature.
6. The addition of  $\text{Fe}^{3+}$  occurred at 14 seconds.
7. A catalyst would decrease the time required to reach equilibrium. This would condense ("squish") the graph along the  $x$ -axis.

**SKILLS AND ATTITUDES OUTCOME**

**C12-0-S7:** Interpret patterns and trends in data, and infer and explain relationships.

---

**SUGGESTIONS FOR ASSESSMENT** 

---

**Paper-and-Pencil Tasks**

1. Students can prepare questions on sketching and interpreting concentration versus time graphs and test their classmates.
2. Have students complete Appendix 4.11: Interpreting Concentration versus Time Graphs.

**LEARNING RESOURCES LINKS** 

---



*McGraw-Hill Ryerson Chemistry, Combined Atlantic Edition* (Mustoe, et al. 527)

*McGraw-Hill Ryerson Inquiry into Chemistry* (Chastko, et al. 647, 648, 650)

*Nelson Chemistry 12, Ontario Edition* (van Kessel, et al. 430, 451–455)

*Prentice Hall Chemistry* (Wilbraham, et al. 550)

**Appendices**

Appendix 4.10: Interpreting Equilibrium Graphs

Appendix 4.11: Interpreting Concentration versus Time Graphs

**Selecting Learning Resources**

For additional information on selecting learning resources for Grade 11 and Grade 12 Chemistry, see the Manitoba Education website at <[www.edu.gov.mb.ca/k12/learnres/bibliographies.html](http://www.edu.gov.mb.ca/k12/learnres/bibliographies.html)>.

## Topic 4: Chemical Equilibrium

### SPECIFIC LEARNING OUTCOME

**C12-4-09:** Discuss practical applications of Le Châtelier's principle.

*Examples: Haber process, hemoglobin production at high altitude, carbonated beverages, eyes adjusting to light, blood pH, recharging of batteries, turbocharged/supercharged engines, ester synthesis, weather indicators, carbonated beverages in a hen's diet . . .*

(1 hour)

SLO: C12-4-09

### SUGGESTIONS FOR INSTRUCTION

#### Entry-Level Knowledge

Students were introduced to Le Châtelier's principle in learning outcome C12-4-06.

#### Assessing Prior Knowledge

Check for students' prior knowledge, and review concepts as necessary. Some examples may have been discussed in addressing previous learning outcomes.

### TEACHER NOTES

#### Practical Applications of Le Châtelier's Principle

The following examples of the practical applications of Le Châtelier's principle are provided to indicate the importance of Le Châtelier's principle in our lives. Students are not expected to learn the examples in great detail. Teachers can either have students collect information from their own textbooks or, if information is limited, through additional research. Some information is provided here for teacher reference.

### General Learning Outcome Connections

- GLO A1:** Recognize both the power and limitations of science as a way of answering questions about the world and explaining natural phenomena.
- GLO A3:** Distinguish critically between science and technology in terms of their respective contexts, goals, methods, products, and values.
- GLO A5:** Recognize that science and technology interact with and advance one another.
- GLO B2:** Recognize that scientific and technological endeavours have been and continue to be influenced by human needs and the societal context of the time.
- GLO B4:** Demonstrate knowledge of and personal consideration for a range of possible science- and technology-related interests, hobbies, and careers.
- GLO C2:** Demonstrate appropriate scientific inquiry skills when seeking answers to questions.
- GLO C5:** Demonstrate curiosity, skepticism, creativity, open-mindedness, accuracy, precision, honesty, and persistence, and appreciate their importance as scientific and technological habits of mind.
- GLO D1:** Understand essential life structures and processes pertaining to a wide variety of organisms, including humans.
- GLO D3:** Understand the properties and structures of matter, as well as various common manifestations and applications of the actions and interactions of matter.
- GLO E2:** Describe and appreciate how the natural and constructed world is made up of systems and how interactions take place within and among these systems.



**SKILLS AND ATTITUDES OUTCOMES**

**C12-0-U1:** Use appropriate strategies and skills to develop an understanding of chemical concepts.

*Examples: analogies, concept frames, concept maps, manipulatives, particulate representations, role-plays, simulations, sort-and-predict frames, word cycles . . .*

**C12-0-R4:** Compare diverse perspectives and interpretations in the media and other information sources.

**C12-0-T1:** Describe examples of the relationship between chemical principles and applications of chemistry.

**C12-0-T3:** Provide examples of how chemical principles are applied in products and processes, in scientific studies, and in daily life.

**C12-0-A3:** Demonstrate a continuing, increasingly informed interest in chemistry and chemistry-related careers and issues.

**C12-0-A4:** Be sensitive and responsible in maintaining a balance between the needs of humans and a sustainable environment.

■ **The Haber Process**

The Haber process, used to produce ammonia from hydrogen and nitrogen, was discovered in 1909 by German chemist Fritz Haber, Nobel Prize winner and “father of chemical warfare.” He is reported to have said, “During peace time a scientist belongs to the world, but during war time he belongs to his country” (Blickenstaff).

Students could research and report on the historical development and importance of Haber’s contributions to chemistry. This project can launch into discussions on the ethics of science and scientists, the obligation of scientists to society, the diverse perspectives and interpretations of science in the media, the role of chemistry in agriculture, and so on.

Most chemistry textbooks include a discussion of the Haber process (e.g., Chang, 9th ed. 630; Chastko, et al. 669). Discussions are also available online.

*Sample Website:*

Clark, Jim. “The Haber Process.” *Chemguide*. 2002.

<[www.chemguide.co.uk/physical/equilibria/haber.html](http://www.chemguide.co.uk/physical/equilibria/haber.html)> (13 Jan. 2012).

This website includes a description of the Haber process for manufacturing ammonia.

■ **Hemoglobin Production and Altitude**

In the body, hemoglobin (Hb) is readily used to transport oxygen to tissues.

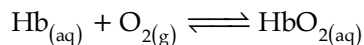

In a place such as Mexico City, where the elevation is 2.3 km above sea level, atmospheric pressure and oxygen concentration are low. To offset the stress, equilibrium favours the reverse direction. As a result, people who live there may experience hypoxia (a lack of oxygen), which can cause headache, nausea, and extreme fatigue. In serious cases, if victims are not treated quickly, they may slip into a coma and die.

**Topic 4:  
Chemical  
Equilibrium****SPECIFIC LEARNING OUTCOME****C12-4-09:** Discuss practical applications of Le Châtelier's principle.

*Examples: Haber process, hemoglobin production at high altitude, carbonated beverages, eyes adjusting to light, blood pH, recharging of batteries, turbocharged/supercharged engines, ester synthesis, weather indicators, carbonated beverages in a hen's diet . . .*

*(continued)*

Individuals living at high altitudes for extended periods of time adapt to reduced oxygen concentrations by producing more hemoglobin. This shifts equilibrium to the right once more, so that the symptoms of hypoxia disappear.

Studies have shown that the Sherpas, long-time residents of the Himalayan mountains, have adapted to high altitude conditions by maintaining high levels of hemoglobin in their blood, sometimes as much as 50 percent more than individuals living at sea level (Chang, 9th ed. 630).

**■ Carbonated Beverages**

Soft drinks are carbonated under high pressure to create the following equilibrium system:

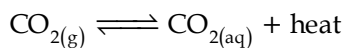

When a bottle of soda pop is opened, the pressure above the carbon dioxide decreases. The system shifts to the left, the solubility of the carbon dioxide drops, and carbon dioxide bubbles out of solution. If the bottle is left open for a long time, the pop will go "flat" due to the reduced pressure.

Shaking a pop bottle will increase the pressure on the system, which will shift to relieve the stress by favouring the forward reaction. Increasing the temperature of a pop bottle (e.g., leaving it in a warm car on a summer day) will cause equilibrium to shift in the reverse direction, creating more carbon dioxide gas. This will generate a pressure that could potentially cause the pop bottle to burst.

**■ Eyes Adjusting to Light**

Photoreceptors, cells containing the visual pigment rhodopsin, line the inner surface of the eyeball. The rhodopsin is made up of opsin (a protein) and retinene (a pigment). When light strikes a photoreceptor, the energy absorbed changes the shape of the retinene portion of the molecule. This forward reaction takes place very quickly. The shape change signals the optic nerve, which carries information to the brain where it is translated into a visual image.

**SKILLS AND ATTITUDES OUTCOMES**

**C12-0-U1:** Use appropriate strategies and skills to develop an understanding of chemical concepts.

*Examples: analogies, concept frames, concept maps, manipulatives, particulate representations, role-plays, simulations, sort-and-predict frames, word cycles . . .*

**C12-0-R4:** Compare diverse perspectives and interpretations in the media and other information sources.

**C12-0-T1:** Describe examples of the relationship between chemical principles and applications of chemistry.

**C12-0-T3:** Provide examples of how chemical principles are applied in products and processes, in scientific studies, and in daily life.

**C12-0-A3:** Demonstrate a continuing, increasingly informed interest in chemistry and chemistry-related careers and issues.

**C12-0-A4:** Be sensitive and responsible in maintaining a balance between the needs of humans and a sustainable environment.

In the absence of light, the retinene is separated from the opsin. It takes time to be able to see in the dark, again because the complex can be recombined with the help of adenosine triphosphate (ATP) molecules in a slower reverse reaction. In a dark room, the photoreceptors in the eyes take a few minutes to re-equilibrate to a lower light intensity, as the reverse reaction is slower. Moving into a brightly lit room, the photoreceptors in the eyes again take a few minutes to adjust to their new equilibrium due to the slower reverse reaction.

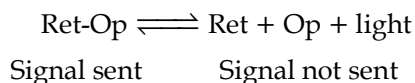

- **Blood pH**

Blood contains dissolved carbonic acid in equilibrium with carbon dioxide and water.

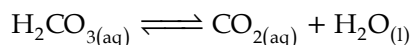

To keep carbonic acid at safe concentrations in the blood, the  $\text{CO}_2$  product is exhaled. The removal of a product causes the forward reaction to be favoured, reducing the amount of carbonic acid to keep blood pH within a safe range (Chang, 9th ed. 706).

- **Rechargeable Batteries**

The following types of batteries are recharged through the addition of electrical energy. When energy is added to the system, the reverse reaction is favoured, which produces more reactants. Balanced chemical equations are provided for each of the following types of batteries.

- lead-acid batteries:

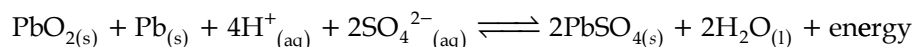

## Topic 4: Chemical Equilibrium

### SPECIFIC LEARNING OUTCOME

**C12-4-09:** Discuss practical applications of Le Châtelier's principle.

*Examples: Haber process, hemoglobin production at high altitude, carbonated beverages, eyes adjusting to light, blood pH, recharging of batteries, turbocharged/supercharged engines, ester synthesis, weather indicators, carbonated beverages in a hen's diet . . .*

(continued)

- nickel-cadmium batteries:

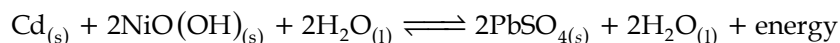

- fuel cells:

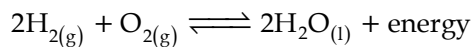

- **Turbocharged/Supercharged Engines**

In a turbocharged engine, air is compressed and heated. This means that there is a higher concentration (50 percent more) of warmer oxygen reacting with the gasoline. This favours the production of products, which generates more power for the car.

Turbochargers in normal engines work best at higher altitudes where the air is less dense. The steam created by the reaction of the gasoline and oxygen is used to turn a turbine that runs the air compressor. In a supercharger, a belt runs the compressor.

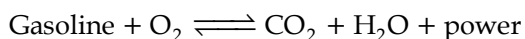

- **Ester Synthesis**

Reactions producing esters favour the reverse reaction. To favour the forward reaction, scientists must increase the amount of acid present in the system.

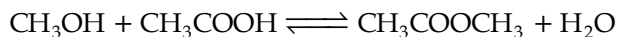

- **Weather Indicators**

Students may have seen that weather indicators are blue under normal conditions but turn pink to indicate approaching rain. The colour changes are due to changes in the colour of cobalt(II) chloride:

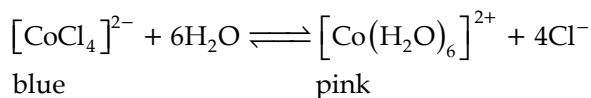

**SKILLS AND ATTITUDES OUTCOMES**

**C12-0-U1:** Use appropriate strategies and skills to develop an understanding of chemical concepts.

*Examples: analogies, concept frames, concept maps, manipulatives, particulate representations, role-plays, simulations, sort-and-predict frames, word cycles . . .*

**C12-0-R4:** Compare diverse perspectives and interpretations in the media and other information sources.

**C12-0-T1:** Describe examples of the relationship between chemical principles and applications of chemistry.

**C12-0-T3:** Provide examples of how chemical principles are applied in products and processes, in scientific studies, and in daily life.

**C12-0-A3:** Demonstrate a continuing, increasingly informed interest in chemistry and chemistry-related careers and issues.

**C12-0-A4:** Be sensitive and responsible in maintaining a balance between the needs of humans and a sustainable environment.

Alternatively, use the equilibrium system

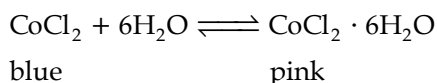

In periods of low humidity, the colour of the weather indicator is blue. When the humidity is high, the products will be favoured and the colour of the indicator will be pink.

■ **Eggs and Soda Pop**

Eggshells are made of calcium carbonate ( $\text{CaCO}_3(\text{s})$ ), which is made from carbon dioxide ( $\text{CO}_2$ ), a product of cellular respiration.

The net equation is

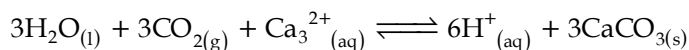

When chickens become hot, they pant, which decreases the concentration of carbon dioxide in the blood. To offset the stress, the equilibrium will shift in the reverse direction and decrease the amount of calcium carbonate available to make eggshells. This yields eggs with thin shells that break easily. Ted Odom, a graduate student at the University of Illinois, found that giving chickens carbonated water to drink will shift equilibrium in the forward direction and minimize the effects of panting on warm days. This allows farmers to minimize the effects without having to install expensive air conditioning in chicken coops (van Kessel, et al. 457).

**Topic 4:  
Chemical  
Equilibrium**

---

**SPECIFIC LEARNING OUTCOME****C12-4-09:** Discuss practical applications of Le Chatelier's principle.

*Examples: Haber process, hemoglobin production at high altitude, carbonated beverages, eyes adjusting to light, blood pH, recharging of batteries, turbocharged/supercharged engines, ester synthesis, weather indicators, carbonated beverages in a hen's diet . . .*

(continued)

---

**SUGGESTIONS FOR ASSESSMENT**

---

**Class Discussion**

To emphasize that the topic of equilibrium is not confined only to the chemistry classroom, have students provide examples of its application in a variety of contexts.

**Research and Reports/Presentations**

Students can research one or more applications of Le Châtelier's principle, including its use in industry. If students are to use the Internet for their research, provide them with key search words to reduce search time. Students can report on their research findings using a variety of formats:

- written reports
- visual displays (e.g., posters)
- formal class presentations

Sample rubrics for assessing research reports and presentations are provided in Appendix 11.

**Collaborative Teamwork**

Use collaborative strategies such as Jigsaw (see *SYSTH* 3.20) or Roundtable discussions (see Appendix 7) to have students share their knowledge of specific examples of Le Chatelier's principle with their classmates.

**Journal Writing**

1. Have students reflect on common examples of Le Châtelier's principle. Students' reflections could be based on examples from their everyday lives or from careers that use the principle.
2. Students can describe how their bodies would relieve the stress placed on them by climbing to a high altitude (Fisher 251).

**SKILLS AND ATTITUDES OUTCOMES**

**C12-0-U1:** Use appropriate strategies and skills to develop an understanding of chemical concepts.

*Examples: analogies, concept frames, concept maps, manipulatives, particulate representations, role-plays, simulations, sort-and-predict frames, word cycles . . .*

**C12-0-R4:** Compare diverse perspectives and interpretations in the media and other information sources.

**C12-0-T1:** Describe examples of the relationship between chemical principles and applications of chemistry.

**C12-0-T3:** Provide examples of how chemical principles are applied in products and processes, in scientific studies, and in daily life.

**C12-0-A3:** Demonstrate a continuing, increasingly informed interest in chemistry and chemistry-related careers and issues.

**C12-0-A4:** Be sensitive and responsible in maintaining a balance between the needs of humans and a sustainable environment.

**Quiz/Test**

Test students on their understanding of the applications of Le Châtelier’s principle, using questions such as the following:

1. When someone takes your photograph, you may see a “ghost” image of the flash for several minutes after the photo is taken. Explain this phenomenon in terms of the rates of the forward and reverse rhodopsin reactions in the eye.

*Answer:*

When the flash occurred, the photoreceptors in the eye responded quickly to the bright burst. However, since the reverse reaction is much slower, and the intensity of the flash was so great, a ghost image can be seen for several minutes while the reactions in the photoreceptors take time to reverse themselves.

2. When isopentyl alcohol and acetic acid react, they form the pleasant-smelling compound isopentyl acetate (the essence of banana oil):

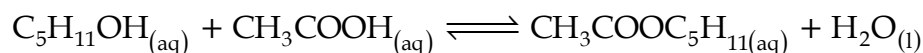

A student adds a drying agent to remove water in an attempt to increase the yield of banana oil. Is this approach reasonable? Explain.

*Answer:*

Adding a drying agent will decrease the amount of water present in the system. To minimize the stress and re-establish equilibrium, the system will favour the production of more products. Thus, adding a drying agent is a reasonable course of action to increase the yield of banana oil.

**Rubrics/Checklists**

See Appendix 11 for a variety of rubrics and checklists that can be used for self-, peer-, and teacher-assessment for any of the research presentations.

**Topic 4:  
Chemical  
Equilibrium**

---

**SPECIFIC LEARNING OUTCOME**

**C12-4-09:** Discuss practical applications of Le Chatelier's principle.

*Examples: Haber process, hemoglobin production at high altitude, carbonated beverages, eyes adjusting to light, blood pH, recharging of batteries, turbocharged/supercharged engines, ester synthesis, weather indicators, carbonated beverages in a hen's diet . . .*

(continued)

---

**LEARNING RESOURCES LINKS**

---



*Chemistry*, 9th ed. (Chang 630, 706)

*Chemistry: The Molecular Nature of Matter and Change* (Silberberg 755)

*Glencoe Chemistry: Concepts and Applications* (Phillips, Strozak, and Wistrom 216)

*Glencoe Chemistry: Matter and Change* (Dingrando, et al. 574, 588)

*Glencoe Chemistry: Matter and Change, Science Notebook* (Fisher 251)

*McGraw-Hill Ryerson Chemistry, Combined Atlantic Edition* (Mustoe, et al. 525, 526, 530)

*McGraw-Hill Ryerson Inquiry into Chemistry* (Chastko, et al. 648, 669)

*Nelson Chemistry 12, Ontario Edition* (van Kessel, et al. 457, 461)

*Nelson Chemistry 12: College Preparation, Ontario Edition* (Davies, et al. 161)

**Websites**

Blickenstaff, Jacob Clark. "Haber: Ethics in the Laboratory." 21 Jan. 2011. *National Science Teachers Association*. <[www.nsta.org/publications/news/story.aspx?id=58157&print=true](http://www.nsta.org/publications/news/story.aspx?id=58157&print=true)> (27 Dec. 2012).

Clark, Jim. "The Haber Process." *Chemguide*. 2002. <[www.chemguide.co.uk/physical/equilibria/haber.html](http://www.chemguide.co.uk/physical/equilibria/haber.html)> (13 Jan. 2012).

**Selecting Learning Resources**

For additional information on selecting learning resources for Grade 11 and Grade 12 Chemistry, see the Manitoba Education website at <[www.edu.gov.mb.ca/k12/learnres/bibliographies.html](http://www.edu.gov.mb.ca/k12/learnres/bibliographies.html)>.



**SKILLS AND ATTITUDES OUTCOMES**

**C12-0-U1:** Use appropriate strategies and skills to develop an understanding of chemical concepts.

*Examples: analogies, concept frames, concept maps, manipulatives, particulate representations, role-plays, simulations, sort-and-predict frames, word cycles . . .*

**C12-0-R4:** Compare diverse perspectives and interpretations in the media and other information sources.

**C12-0-T1:** Describe examples of the relationship between chemical principles and applications of chemistry.

**C12-0-T3:** Provide examples of how chemical principles are applied in products and processes, in scientific studies, and in daily life.

**C12-0-A3:** Demonstrate a continuing, increasingly informed interest in chemistry and chemistry-related careers and issues.

**C12-0-A4:** Be sensitive and responsible in maintaining a balance between the needs of humans and a sustainable environment.

---

**NOTES**

**Topic 4:  
Chemical  
Equilibrium**

**SPECIFIC LEARNING OUTCOMES**

**C12-4-10:** Write solubility product ( $K_{sp}$ ) expressions from balanced chemical equations for salts with low solubility.

**C12-4-11:** Solve problems involving  $K_{sp}$ .

Include: common ion problems

(3.5 hours)

SLO: C12-4-10  
SLO: C12-4-11

**SUGGESTIONS FOR INSTRUCTION**

**Entry-Level Knowledge**

In addressing learning outcomes C12-1-01 and C12-1-02, students saw reactions that produce precipitates.

**TEACHER NOTES**

**Solubility Product Constants**

In addressing learning outcomes C12-4-10 and C12-4-11, students should become aware that the precipitates formed by double displacement reactions are not insoluble, but *slightly soluble*. For example, while a solubility table would indicate that silver chloride (AgCl) is insoluble, it does undergo both dissociation and precipitation to set up the equilibrium

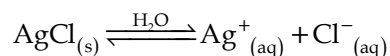

Earlier in Topic 4, students calculated equilibrium constants using the ratio of product concentrations (raised to the value of their coefficients from the balanced equation) to reactant concentrations (raised to the value of their coefficients from the balanced equation) at equilibrium.

$$K_{eq} = \frac{[\text{Ag}^+_{(aq)}][\text{Cl}^-_{(aq)}]}{[\text{AgCl}_{(s)}]}$$

Since solids are not included in equilibrium expressions, as their concentrations are constant, solubility product constants are calculated using only the concentrations of products at equilibrium.

$$K_{sp} = [\text{Ag}^+][\text{Cl}^-]$$

Like equilibrium constants, solubility product constants are specific for only one reaction at a particular temperature. The higher the  $K_{sp}$  value is, the higher the solubility of the salt will be.

**General Learning Outcome Connections**

**GLO D3:** Understand the properties and structures of matter, as well as various common manifestations and applications of the actions and interactions of matter.

**SKILLS AND ATTITUDES OUTCOME**

**C12-0-U1:** Use appropriate strategies and skills to develop an understanding of chemical concepts.

*Examples: analogies, concept frames, concept maps, manipulatives, particulate representations, role-plays, simulations, sort-and-predict frames, word cycles . . .*

*Examples:*

The following  $K_{sp}$  values are given for some salts at 25°C (Chang 720):

- calcium phosphate       $K_{sp} = 1.2 \times 10^{-26}$
- silver bromide           $K_{sp} = 7.7 \times 10^{-13}$
- barium fluoride          $K_{sp} = 1.7 \times 10^{-6}$

In these examples, barium fluoride ( $\text{BaF}_2$ ) has a higher solubility than the other two salts, calcium phosphate ( $\text{Ca}_3(\text{PO}_4)_2$ ) and silver bromide ( $\text{AgBr}$ ) because  $\text{BaF}_2$  has the larger  $K_{sp}$  value. Calcium phosphate will dissolve very slightly in water due to its very low  $K_{sp}$  value.

Be sure to clarify the difference between *solubility* (the number of moles of solute that will dissolve in 1 L of solution, known as concentration) and *solubility product* (the product of the concentrations of ions in solution, raised to the powers of their coefficients in the balanced equation).

In chemistry textbooks, units for  $K_{sp}$  are not used because they would vary depending on the powers to which the concentrations are raised, such as mol/L to  $(\text{mol/L})^2$  to  $(\text{mol/L})^3$ .

Visual representations can be viewed online.

*Sample Website:*

University of Colorado at Boulder. "Salts and Solubility." *PhET Interactive Simulations*. <<http://phet.colorado.edu/en/simulation/soluble-salts>> (22 Nov. 2012).

In this simulation, students can add different salts to water and watch them dissolve and achieve a dynamic equilibrium with a solid precipitate. They compare the number of ions in solution for highly soluble NaCl to other slightly soluble salts and calculate  $K_{sp}$  values.

**Solving  $K_{sp}$  Problems**

When asking students to solve problems involving  $K_{sp}$ , limit the problems to

- calculating the  $K_{sp}$ , given the molar solubility of a compound
- using an ICE table to solve for the molar solubility of a slightly soluble salt
- identifying the concentration of ions present at equilibrium when the  $K_{sp}$  value of the slightly soluble salt has been provided
- determining the molar solubility of a slightly soluble salt in a solution containing a known concentration of a common ion

**Topic 4:  
Chemical  
Equilibrium**

**SPECIFIC LEARNING OUTCOMES**

**C12-4-10:** Write solubility product ( $K_{sp}$ ) expressions from balanced chemical equations for salts with low solubility.

**C12-4-11:** Solve problems involving  $K_{sp}$ .  
Include: common ion problems

(continued)

Sample problems and solutions follow.

*Example 1:*

*Calculate the  $K_{sp}$ , given the molar solubility of a compound.*

The solubility of calcium sulphate ( $\text{CaSO}_4$ ) is  $4.9 \times 10^{-3}$  mol/L. Calculate the  $K_{sp}$  for  $\text{CaSO}_4$ .

*Solution:*

- Write the dissociation equation for  $\text{CaSO}_4$ .

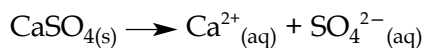

- Write the ion-product, or  $K_{sp}$ , expression.

$$K_{sp} = [\text{Ca}^{2+}][\text{SO}_4^{2-}]$$

- Substitute the molar concentrations of the ions,  $\text{Ca}^{2+}$  and  $\text{SO}_4^{2-}$ , into the  $K_{sp}$  expression and solve the problem.

$$K_{sp} = [4.9 \times 10^{-3} \text{ mol/L}][4.9 \times 10^{-3} \text{ mol/L}]$$

$$K_{sp} = 2.4 \times 10^{-5}$$

*Example 2:*

*Use an ICE table to solve for the molar solubility of a slightly soluble salt.*

Calculate the molar solubility of lead chloride ( $\text{PbCl}_2$ ) in pure water at  $25^\circ\text{C}$ .  $K_{sp}$  for  $\text{PbCl}_2$  is  $2 \times 10^{-5}$ .

*Solution:*

- Write the dissociation equation for  $\text{PbCl}_2$ .

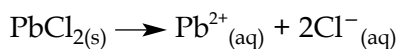

- Set up an ICE table and fill in the values for the unknown ions. Note that for every  $\text{Pb}^{2+}$  ion there are two  $\text{Cl}^{-}$  ions, which can be seen from the balanced equation

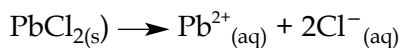

I	?	0	0
C	?	+ x	+ 2x
E	?	x	2x

**SKILLS AND ATTITUDES OUTCOME**

**C12-0-U1:** Use appropriate strategies and skills to develop an understanding of chemical concepts.

*Examples: analogies, concept frames, concept maps, manipulatives, particulate representations, role-plays, simulations, sort-and-predict frames, word cycles . . .*

3. Write the ion-product, or  $K_{sp}$ , expression and substitute the known values into the expression.

$$K_{sp} = [\text{Pb}^{2+}][\text{Cl}^-]^2$$

$$2 \times 10^{-5} = (x)(2x)^2$$

4. Solve for  $x$ .

$$2 \times 10^{-5} = 4x^3$$

$$x^3 = 5 \times 10^{-6}$$

$$x = 1.7 \times 10^{-2} \text{ mol/L}$$

The molar solubility of  $\text{PbCl}_2$  in pure water at  $25^\circ\text{C}$  is

$$1.7 \times 10^{-2} \text{ mol/L}$$

*Example 3:*

*Identify the concentration of ions present at equilibrium when the  $K_{sp}$  value of the slightly soluble salt has been provided.*

What is the concentration of silver and chloride ions in a saturated silver chloride ( $\text{AgCl}$ ) solution at  $25^\circ\text{C}$ ?

$$K_{sp} = 1.8 \times 10^{-10}$$

*Solution:*

1. Write the dissociation equation for  $\text{AgCl}$ .



2. Set up an ICE table and fill in the table for the unknown values of the ions,  $x$ .

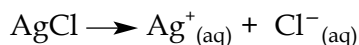

I	?	0	0
C	?	+ $x$	+ $x$
E	?	$x$	$x$

3. Write the ion-product, or  $K_{sp}$ , expression and substitute the known values into the expression.

$$K_{sp} = [\text{Ag}^+][\text{Cl}^-]$$

$$1.8 \times 10^{-10} = (x)(x)$$

**Topic 4:  
Chemical  
Equilibrium**

**SPECIFIC LEARNING OUTCOMES**

**C12-4-10:** Write solubility product ( $K_{sp}$ ) expressions from balanced chemical equations for salts with low solubility.

**C12-4-11:** Solve problems involving  $K_{sp}$ .  
Include: common ion problems

(continued)

4. Solve for  $x$ .

$$1.8 \times 10^{-10} = (x)^2$$

$$x^2 = 1.8 \times 10^{-10}$$

$$x = 1.3 \times 10^{-5} \text{ mol/L}$$

The molar solubilities of the ions at equilibrium are equal to

$$x = [\text{Ag}^+] = [\text{Cl}^-] = 1.3 \times 10^{-5} \text{ mol/L}$$

*Example 4:*

*Determine the molar solubility of a slightly soluble salt in a solution containing a known concentration of a common ion.*

Calculate the molar solubility of silver chloride ( $\text{AgCl}$ ) in a  $1.5 \times 10^{-3}$  mol/L silver nitrate ( $\text{AgNO}_3$ ) solution.

$$K_{sp} \text{ for AgCl} = 1.6 \times 10^{-10}$$

*Solution:*

This is a common ion problem. The common ion is  $\text{Ag}^+$ , which is present in  $\text{AgCl}$  and  $\text{AgNO}_3$ . Note that the presence of the common ion affects the solubility of  $\text{AgCl}$  (in mol/L) but not the  $K_{sp}$  value because it is an equilibrium constant.

1.  $\text{AgNO}_3$  dissociates completely, as shown by the equation



Since the concentration of  $\text{AgNO}_3$  is given as  $1.5 \times 10^{-3}$  mol/L,

$$[\text{Ag}^+] = 1.5 \times 10^{-3} \text{ mol/L}$$

Write the dissociation equation for  $\text{AgCl}$ .



**SKILLS AND ATTITUDES OUTCOME**
**C12-0-U1:** Use appropriate strategies and skills to develop an understanding of chemical concepts.

*Examples: analogies, concept frames, concept maps, manipulatives, particulate representations, role-plays, simulations, sort-and-predict frames, word cycles . . .*

2. Set up an ICE table and fill in the values for the unknown ions. Remember that there are two sources for the  $\text{Ag}^+$  ion,  $1.5 \times 10^{-3}$  mol/L from  $\text{AgNO}_3$ , and the unknown amount,  $x$ , from  $\text{AgCl}$ .

	$\text{AgCl}_{(s)}$	$\longrightarrow$	$\text{Ag}^+_{(aq)}$	+	$\text{Cl}^-_{(aq)}$
I	?		$1.5 \times 10^{-3}$		0
C	?		+ $x$		+ $x$
E	?		$1.5 \times 10^{-3} + x$		$x$

3. Write the ion-product, or  $K_{\text{sp}}$ , expression and substitute the known values into the expression.

$$K_{\text{sp}} = [\text{Ag}^+][\text{Cl}^-]$$

$$1.6 \times 10^{-10} = (1.5 \times 10^{-3} + x)(x)$$



This  $x$  can be ignored because the amount of  $\text{Ag}^+$  ion that can dissolve from  $\text{AgCl}$  is very small compared to the amount of  $\text{Ag}^+$  generated from  $\text{AgNO}_3$ .

4. Solve for  $x$ .

$$1.6 \times 10^{-10} = (1.5 \times 10^{-3})(x)$$

$$x = 1.1 \times 10^{-7}$$

$$[\text{AgCl}] = 1.1 \times 10^{-7} \text{ mol/L}$$

The molar solubility of  $\text{AgCl}$  in a  $1.5 \times 10^{-3}$  mol/L solution  $\text{AgNO}_{3(aq)}$  is

$$1.1 \times 10^{-7} \text{ mol/L}$$

**Topic 4:**  
**Chemical**  
**Equilibrium**

## SPECIFIC LEARNING OUTCOMES

**C12-4-10:** Write solubility product ( $K_{sp}$ ) expressions from balanced chemical equations for salts with low solubility.

**C12-4-11:** Solve problems involving  $K_{sp}$ .  
Include: common ion problems

(continued)

## SUGGESTIONS FOR ASSESSMENT

### Paper-and-Pencil Tasks

Have students write  $K_{sp}$  expressions from given chemical equations.

- Write the expression for the solubility product constant for strontium sulphate ( $\text{SrSO}_4$ ).

*Answer:*

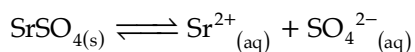

$$K_{sp} = [\text{Sr}^{2+}][\text{SO}_4^{2-}]$$

- Write the expression for the solubility product constant for aluminum sulphate  $\text{Al}_2(\text{SO}_4)_3$ .

*Answer:*

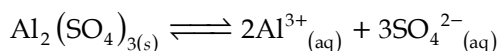

$$K_{sp} = [\text{Al}^{3+}]^2[\text{SO}_4^{2-}]^3$$

*Sample Problems:*

- A sample of barium hydroxide ( $\text{Ba}(\text{OH})_{2(s)}$ ) is added to pure water and allowed to come to equilibrium at  $25^\circ\text{C}$ . The concentration of  $\text{Ba}^{2+}$  is found to be  $0.108 \text{ mol/L}$  and that of  $\text{OH}^-$  is found to be  $0.216 \text{ mol/L}$ . What is the value of  $K_{sp}$  for  $\text{Ba}(\text{OH})_{2(s)}$ ?

*Answer:*

$$K_{sp} = 5.04 \times 10^{-3}$$

- What is the molar solubility of a saturated solution of silver chloride ( $\text{AgCl}$ )?  $K_{sp} = 1.6 \times 10^{-10}$ .

*Answer:*

$$\text{AgCl} = 1.26 \times 10^{-5} \text{ mol/L}$$



**SKILLS AND ATTITUDES OUTCOME**

**C12-0-U1:** Use appropriate strategies and skills to develop an understanding of chemical concepts.

*Examples: analogies, concept frames, concept maps, manipulatives, particulate representations, role-plays, simulations, sort-and-predict frames, word cycles . . .*

3. What will be the equilibrium concentrations of  $\text{Ca}^{2+}$  and  $\text{OH}^-$  in a saturated solution of calcium hydroxide ( $\text{Ca}(\text{OH})_2$ ) if its  $K_{\text{sp}}$  value is  $1.3 \times 10^{-6}$ ?

*Answer:*

$$[\text{Ca}^{2+}] = 6.9 \times 10^{-3} \text{ mol/L}$$

$$[\text{OH}^-] = 1.4 \times 10^{-2} \text{ mol/L}$$

4. Calculate the molar solubility of calcium iodate ( $\text{Ca}(\text{IO}_3)_2$ ) in 0.060 mol/L sodium iodate ( $\text{NaIO}_3$ ). The  $K_{\text{sp}}$  of  $\text{Ca}(\text{IO}_3)_2$  is  $7.1 \times 10^{-7}$ .

*Answer:*

$$2.0 \times 10^{-4} \text{ mol/L}$$

**Extension:**

5. Will a precipitate form when 1.00 L of 0.150 mol/L iron(II) chloride solution ( $\text{FeCl}_2$ ) is mixed with 2.00 L of 0.0333 mol/L sodium hydroxide solution ( $\text{NaOH}$ )?

*Answer:*

Trial  $K_{\text{sp}}$  or  $Q_{\text{sp}} = 2.46 \times 10^{-5}$ ,  $K_{\text{sp}} = 4.9 \times 10^{-17}$ .  $Q_{\text{sp}} > K_{\text{sp}}$ , so a precipitate will form.

**Journal Writing**

Have students “explain how adding additional sulfate ions to a saturated solution of barium sulfate would affect the concentration of barium ions” (Dingrando, et al., *Glencoe Chemistry: Matter and Change, Teacher Wraparound Edition* 577).

**LEARNING RESOURCES LINKS**

*Chemistry*, 9th ed. (Chang 720)

*Chemistry* (Zumdahl and Zumdahl 757)

*Chemistry: The Molecular Nature of Matter and Change* (Silberberg 833)

*Glencoe Chemistry: Matter and Change* (Dingrando, et al. 577)

*Glencoe Chemistry: Matter and Change, Teacher Wraparound Edition* (Dingrando, et al 577)

*Nelson Chemistry 12, Ontario Edition* (van Kessel, et al. 483, 490)

*Prentice Hall Chemistry* (Wilbraham, et al. 560)

**Topic 4:  
Chemical  
Equilibrium**

---

**SPECIFIC LEARNING OUTCOMES**

**C12-4-10:** Write solubility product ( $K_{sp}$ ) expressions from balanced chemical equations for salts with low solubility.

**C12-4-11:** Solve problems involving  $K_{sp}$ .  
Include: common ion problems

(continued)

---

**Website**

University of Colorado at Boulder. "Salts and Solubility." *PhET Interactive Simulations*. <<http://phet.colorado.edu/en/simulation/soluble-salts>> (22 Nov. 2012).

**Selecting Learning Resources**

For additional information on selecting learning resources for Grade 11 and Grade 12 Chemistry, see the Manitoba Education website at <[www.edu.gov.mb.ca/k12/learnres/bibliographies.html](http://www.edu.gov.mb.ca/k12/learnres/bibliographies.html)>.

**SKILLS AND ATTITUDES OUTCOME**

**C12-0-U1:** Use appropriate strategies and skills to develop an understanding of chemical concepts.

*Examples: analogies, concept frames, concept maps, manipulatives, particulate representations, role-plays, simulations, sort-and-predict frames, word cycles . . .*

---

**NOTES**

**Topic 4:  
Chemical  
Equilibrium**

**SPECIFIC LEARNING OUTCOME**

**C12-4-12:** Describe examples of the practical applications of salts with low solubility.

*Examples: kidney stones, limestone caverns, osteoporosis, tooth decay . . .*

(0.5 hour)

SLO: C12-4-12

**SUGGESTIONS FOR INSTRUCTION**

**TEACHER NOTES**

**Practical Applications of Salts with Low Solubility**

The following examples of the practical applications of salts with low solubility are provided to indicate the importance of slightly soluble salts in our lives. Students are not expected to learn the examples in great detail. Teachers can either have students collect information from their own textbooks or, if information is limited, through additional research. Some information is provided here for teacher reference.

■ **Limestone Caverns**

Limestone ( $\text{CaCO}_3$ ) is formed through the decay of marine organisms such as snails, clams, corals, and algae. In water, the slightly soluble salt will set up the following equilibrium:

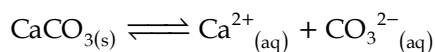

The chemical erosion of limestone occurs when it is in contact with acidic water:

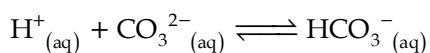

If the limestone deposit is deep enough underground, the dissolution of the limestone produces a cave.

**General Learning Outcome Connections**

- GLO A5:** Recognize that science and technology interact with and advance one another.
- GLO B2:** Recognize that scientific and technological endeavours have been and continue to be influenced by human needs and the societal context of the time.
- GLO C2:** Demonstrate appropriate scientific inquiry skills when seeking answers to questions.
- GLO C4:** Demonstrate appropriate critical thinking and decision-making skills when choosing a course of action based on scientific and technological information.
- GLO C7:** Work cooperatively and value the ideas and contributions of others while carrying out scientific and technological activities.
- GLO D3:** Understand the properties and structures of matter, as well as various common manifestations and applications of the actions and interactions of matter.

**SKILLS AND ATTITUDES OUTCOMES**

**C12-0-U1:** Use appropriate strategies and skills to develop an understanding of chemical concepts.

*Examples: analogies, concept frames, concept maps, manipulatives, particulate representations, role-plays, simulations, sort-and-predict frames, word cycles . . .*

**C12-0-C1:** Collaborate with others to achieve group goals and responsibilities.

**C12-0-T3:** Provide examples of how chemical principles are applied in products and processes, in scientific studies, and in daily life.

■ **Osteoporosis**

Approximately 99 percent of the body's calcium is stored in the bones, where it forms the following equilibrium system:

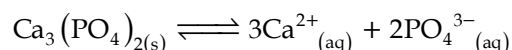

When the concentration of calcium in the blood decreases, balance can be restored if the solubility of the calcium phosphate (bone) increases. This leads to the development of porous, brittle bones. We can prevent this from happening by obtaining the minimum daily requirement of calcium (especially between the ages of 10 and 20 when bone growth is most rapid) and through regular weight-bearing exercise. Note, however, that large amounts of calcium in the body may lead to the formation of kidney stones.

■ **Tooth Decay**

The major constituent of tooth enamel is hydroxyapatite ( $\text{Ca}_5(\text{PO}_4)_3\text{OH}$ ,  $K_{\text{sp}} = 6.8 \times 10^{-37}$ ). In the mouth, the following equilibrium is established:

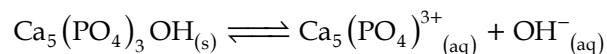

When sugar ferments on the teeth, the hydronium ion is produced. It reacts with the hydroxide ion from the previous reaction, causing the forward reaction to be favoured. An increase in the solubility of the hydroxyapatite leads to the dissolving of tooth enamel. In recent years, fluoride has been added to water and toothpaste. The fluoride ion replaces the hydroxide ion in hydroxyapatite to create fluorapatite ( $\text{Ca}_5(\text{PO}_4)_3\text{F}$ ,  $K_{\text{sp}} = 1.0 \times 10^{-60}$ ). As the fluorapatite is less soluble in water, teeth become more resistant to cavities.

The addition of fluoride to toothpaste has been helpful in preventing tooth decay; however, fluoride is not added to children's toothpaste because an excess of fluoride in the body from swallowing large amounts of paste can lead to fluorosis, damaging teeth and bones.

**Topic 4:  
Chemical  
Equilibrium****SPECIFIC LEARNING OUTCOME****C12-4-12:** Describe examples of the practical applications of salts with low solubility.*Examples: kidney stones, limestone caverns, osteoporosis, tooth decay . . .*

---

*(continued)*

---

**SUGGESTIONS FOR ASSESSMENT**

---

**Class Discussion**

To emphasize that the topic of the solubility of slightly soluble salts is not confined to the chemistry classroom, have students provide examples of its practical application in a variety of contexts.

**Research and Reports/Presentations**

1. Students can research and report on one or more applications of salts with low solubility. Results can be shared in written, verbal, or electronic format. If students are to use the Internet for their research, provide them with key search words to reduce search time.
2. Using their research, students can describe how the solubility of slightly soluble salts is used in industry. Information may be shared with the entire class through formal presentations.
3. Students could research the insoluble lead compounds that, for many years, were used as paint pigments, which led to people, especially children, being poisoned by exposure to lead-based paints (Dingrando et al., *Glencoe Chemistry: Matter and Change, Teacher Wraparound Edition* 578).

**Visual Displays**

Students can create visual displays (e.g., posters) to demonstrate practical applications of the solubility of slightly soluble salts. Samples of presentation rubrics are provided in Appendix 11.

**Collaborative Teamwork**

Collaborative strategies such as Jigsaw (see *SYSTH* 3.20) or Roundtable (see Appendix 7) could be used to have students share their knowledge of specific applications of the solubility of slightly soluble salts with their classmates.

**Journal Writing**

Have students reflect on common applications of the solubility of slightly soluble salts. Students' reflections could be based on examples from their everyday lives or on career-related applications.

### SKILLS AND ATTITUDES OUTCOMES

**C12-0-U1:** Use appropriate strategies and skills to develop an understanding of chemical concepts.

*Examples: analogies, concept frames, concept maps, manipulatives, particulate representations, role-plays, simulations, sort-and-predict frames, word cycles . . .*

**C12-0-C1:** Collaborate with others to achieve group goals and responsibilities.

**C12-0-T3:** Provide examples of how chemical principles are applied in products and processes, in scientific studies, and in daily life.

---

### LEARNING RESOURCES LINKS

---



*Chemistry* (Chang 719)

*Chemistry: The Molecular Nature of Matter and Change* (Silberberg 840)

*Glencoe Chemistry: Matter and Change, Teacher Wraparound Edition* (Dingrando, et al 578)

*Nelson Chemistry 12, Ontario Edition* (van Kessel, et al. 482)

#### Selecting Learning Resources

For additional information on selecting learning resources for Grade 11 and Grade 12 Chemistry, see the Manitoba Education website at <[www.edu.gov.mb.ca/k12/learnres/bibliographies.html](http://www.edu.gov.mb.ca/k12/learnres/bibliographies.html)>.

**Topic 4:**  
**Chemical**  
**Equilibrium**

**SPECIFIC LEARNING OUTCOME**

**C12-4-13:** Perform a laboratory activity to determine the  $K_{sp}$  of a salt with low solubility.

(1.5 hours)

SLO: C12-4-13

**SUGGESTIONS FOR INSTRUCTION**

**Entry-Level Knowledge**

In addressing learning outcome C12-4-11, students solved problems involving  $K_{sp}$ . Learning outcome C12-4-13 provides students with an opportunity to use experimental data to calculate the value of  $K_{sp}$  for a slightly soluble salt.

**Laboratory Activities**

Have students perform a lab activity to determine the  $K_{sp}$  of a salt with low solubility. Possible lab activities are suggested below.

- **Experiment 39: A Solubility Product Constant** (Wilbraham, Staley, and Matta 243)

The purpose of this lab activity is to determine the solubility product constant of lead(II) chloride ( $PbCl_2$ ). Students add 100 mL of saturated  $PbCl_2$  to 20 mL of 0.5 mol/L potassium chromate ( $K_2CrO_4$ ) solution. The mixture is heated to the boiling point and then left to stand and cool for at least five minutes. Students decant the liquid from the beaker, making sure most of the precipitate stays in the beaker. The filter paper is placed in the beaker with the precipitate and then dried. The  $K_{sp}$  of  $PbCl_2$  is then determined through a series of calculations.

- **Chemlab 18: Comparing Two Solubility Product Constants** (Dingrando, et al. 586)

The objectives of this lab activity are to compare the values of the  $K_{sp}$  for two different compounds and relate them to observations, to explain observations of the two precipitates using Le Châtelier's principle, and to calculate the molar solubilities of the two ionic compounds from their  $K_{sp}$  values. As this is a small-scale lab activity, minimal quantities of chemicals are used. Students add 10 drops of silver nitrate ( $AgNO_{3(aq)}$ ) and 10 drops of sodium chloride ( $NaCl_{(aq)}$ ) to two wells of a microplate, and observe that the precipitates that form, silver chloride ( $AgCl_{(s)}$ ), are white. To the second well, students add 10 drops of sodium sulphide ( $Na_2S$ ) solution. The precipitate that forms, silver sulphide ( $Ag_2S_{(s)}$ ), is black.

**General Learning Outcome Connections**

**GLO C2:** Demonstrate appropriate scientific inquiry skills when seeking answers to questions.

**GLO C5:** Demonstrate curiosity, skepticism, creativity, open-mindedness, accuracy, precision, honesty, and persistence, and appreciate their importance as scientific and technological habits of mind.



**SKILLS AND ATTITUDES OUTCOMES**

**C12-0-S5:** Collect, record, organize, and display data using an appropriate format.

Examples: labelled diagrams, graphs, multimedia applications, software integration, probeware . . .

**C12-0-S6:** Estimate and measure accurately using Système International (SI) and other standard units.

Examples: SI conversions and significant figures

- **Investigation 7.6.1: Determining the  $K_{sp}$  of Calcium Oxalate** (van Kessel, et al. 517)

For this investigation, students determine the  $K_{sp}$  of calcium oxalate ( $\text{CaC}_2\text{O}_4$ ) by mixing a fixed volume of 0.1 mol/L sodium oxalate ( $\text{Na}_2\text{C}_2\text{O}_4$ ) with a serial dilution of aqueous calcium nitrate ( $\text{Ca}(\text{NO}_3)_2$ ) in a series of spot-plate wells.

**SUGGESTIONS FOR ASSESSMENT****Laboratory Reports**

Students could use the Laboratory Report Format to write their lab reports (see *SYSTH* 14.12). Word processing and spreadsheet software could be used to prepare reports. Also refer to the Lab Report Assessment rubric in Appendix 11.

**Laboratory Skills**

Periodically and randomly review the lab skills of individual students, so that eventually all students are assessed. Develop a checklist for the assessment of skills related to measuring and mixing solutions. Sample checklists for assessing lab skills and work habits are available in *SYSTH* (6.10, 6.11).

**LEARNING RESOURCES LINKS****Investigations**

*Glencoe Chemistry: Matter and Change* (Dingrando, et al.)

Chemlab 18: Comparing Two Solubility Product Constants, 586

*Nelson Chemistry 12, Ontario Edition* (van Kessel, et al.)

Investigation 7.6.1: Determining the  $K_{sp}$  of Calcium Oxalate, 517

*Prentice Hall Chemistry: Laboratory Manual* (Wilbraham, Staley, and Matta)

Experiment 39: A Solubility Product Constant, 243

**Selecting Learning Resources**

For additional information on selecting learning resources for Grade 11 and Grade 12 Chemistry, see the Manitoba Education website at <[www.edu.gov.mb.ca/k12/learnres/bibliographies.html](http://www.edu.gov.mb.ca/k12/learnres/bibliographies.html)>.



# TOPIC 4: CHEMICAL EQUILIBRIUM

## APPENDICES

---

- Appendix 4.1: Preparation of Equilibrium Systems (Demonstration) 3
- Appendix 4.2: Solving Equilibrium Problems Using the ICE Table Method 5
- Appendix 4.3: Solving for  $K_{eq}$  Using the BIR/PEC Accounting Method 7
- Appendix 4.4: Equilibrium Problems 9
- Appendix 4.5: Chemical Equilibrium: Lab Activity 10
- Appendix 4.6A: An Analogy for an Equilibrium Reaction: Lab Activity 13
- Appendix 4.6B: An Analogy for an Equilibrium Reaction: Lab Activity (Teacher Notes) 15
- Appendix 4.6C: An Analogy for an Equilibrium Reaction: Lab Report Checklist 16
- Appendix 4.7: Equilibrium and Le Châtelier's Principle (Pre-lab) 17
- Appendix 4.8A: Qualitative Equilibrium: Lab Activity 18
- Appendix 4.8B: Qualitative Equilibrium: Lab Activity (Teacher Notes) 19
- Appendix 4.9: Disrupting Equilibrium Systems: Lab Activity 20
- Appendix 4.10: Interpreting Equilibrium Graphs 24
- Appendix 4.11: Interpreting Concentration versus Time Graphs 27



## Appendix 4.1: Preparation of Equilibrium Systems (Demonstration)

### Nitrogen Dioxide–Dinitrogen Tetraoxide (NO<sub>2</sub>–N<sub>2</sub>O<sub>4</sub>) System

Prepare nitrogen(IV) oxide by treating copper turnings with concentrated nitric acid in a fume hood. Collect the gas in three vials of approximately 15 mL capacity. When the vials are filled with gas, quickly seal the ends. The colour intensity in each vial should be about the same.

**Caution:**

- Wear rubber gloves and goggles for personal protection.
- Prepare the vials in a fume hood.
- See Material Safety Data Sheets (MSDS) for further information.

### Procedure (Demonstration)

1. Place the three vials in beakers of water at 0°C, 100°C, and room temperature respectively. The depth of colour shown in the three vials is a direct indication of the extent of the thermal dissociation in the reaction:

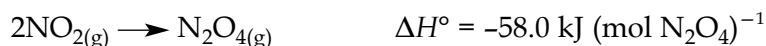

2. Have students compare the colours of the gases in the three vials.
3. Illustrate reversibility by placing the vial at 100°C into the water at 0°C. The vials can also be removed from the 0°C and 100°C beakers and allowed to reach room temperature.

**Note:** These manipulations can also be useful in the discussion of Le Châtelier's principle.

### Tetrachlorocobalt(II)–Aquocobalt(II) (CoCl<sub>4</sub><sup>2-</sup>–Co(H<sub>2</sub>O)<sub>6</sub><sup>2+</sup>) System

#### Materials

two 600 mL beakers  
 two 500 mL Erlenmeyer (conical) flasks  
 hot plate  
 2-propanol (isopropyl alcohol)  
 absolute ethanol (95% ethanol can be substituted for the absolute ethanol)  
 water  
 concentrated hydrochloric acid

#### Procedure

1. In one beaker, dissolve 10 g of cobalt(II) chloride (CoCl<sub>2</sub>) in 500 mL of ethanol. In the other beaker dissolve 10 g of cobalt(II) chloride in 500 mL of water. Note the colours of the solutions. (The blue colour is due to the tetrahedrally coordinated CoCl<sub>4</sub><sup>2-</sup>. The pink colour is due to the octahedrally coordinated Co(H<sub>2</sub>O)<sub>6</sub><sup>2+</sup>.)

Appendix 4.1: Preparation of Equilibrium Systems (Demonstration) (continued)

---

2. Slowly add **just enough** water to the blue ethanol solution to change the colour to pink. Divide this pink solution into two equal volumes in the Erlenmeyer flasks. Add concentrated hydrochloric acid to one flask until the blue colour reappears. Heat the other portion of pink solution on the hot plate until it turns blue again. The hot solution may be cooled in an ice bath to restore the pink colour.

**Note:** A similar solution can be prepared directly by mixing 20 mL of 0.50 mol/L cobalt(II) chloride solution with 16 mL of saturated sodium chloride (NaCl) solution. When this mixture is chilled in cold water, it will turn pink, and when it is heated for a brief time in a Bunsen flame, it will turn blue. The process may be repeated at will.

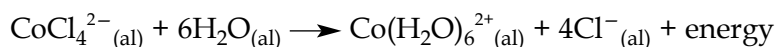

## Appendix 4.2: Solving Equilibrium Problems Using the ICE Table Method

A convenient way to organize data for equilibrium problems is to use an ICE table:

- I** Initial – the initial concentrations of the reactants and products
- C** Change – the change in reactants and products from the initial conditions to equilibrium
- E** Equilibrium – the concentrations of the reactants and products at equilibrium

To set up the table, record the balanced chemical equation. Write the letters I, C, and E on the left side of the table. Insert the known values in the table, and use  $x$  to represent the value that needs to be calculated. See the example below.

### Sample Problem

In a lab experiment, 0.500 mol hydrogen ( $\text{H}_2$ ) and 0.500 mol iodine ( $\text{I}_2$ ) are placed in a 1.00 L flask at  $430^\circ\text{C}$ . The equilibrium constant,  $K_{\text{eq}}$  is 54.3 at this temperature. Calculate the concentrations of  $\text{H}_2$ ,  $\text{I}_2$ , and hydrogen iodide (HI) at equilibrium.

*Solution:*

- Set up the ICE table and fill in known values.

	$\text{H}_2(\text{g})$	+	$\text{I}_2(\text{g})$	$\rightleftharpoons$	$2\text{HI}(\text{g})$
<b>I</b>	0.500 mol/L		0.500 mol/L		0 mol/L
<b>C</b>	$-x$		$-x$		$2x$
<b>E</b>	$0.500 \text{ mol/L} - x$		$0.500 \text{ mol/L} - x$		$2x$

- Write the equilibrium expression for the reaction.

$$K_{\text{eq}} = \frac{[\text{HI}]^2}{[\text{H}_2][\text{I}_2]}$$

- Substitute the values at equilibrium into the expression.

$$54.3 = \frac{(2x)^2}{(0.500 - x)(0.500 - x)}$$

- Take the square root of both sides.

$$7.37 = \frac{2x}{0.500 - x}$$

Appendix 4.2: Solving Equilibrium Problems Using the ICE Table Method (*continued*)

---

5. Rearrange the equation and solve for  $x$ .

$$7.37(0.500 - x) = 2x$$

$$3.685 - 7.37x = 2x$$

$$3.685 = 2x + 7.37x$$

$$3.685 = 9.37x$$

$$x = \frac{3.685}{9.37} = 0.393 \text{ mol/L}$$

6. At equilibrium, the concentration of  $\text{H}_2$ ,  $\text{I}_2$ , and  $\text{HI}$  are as follows:

$$[\text{H}_2] = 0.500 \text{ mol/L} - x = 0.500 \text{ mol/L} - 0.393 \text{ mol/L} = 0.107 \text{ mol/L}$$

$$[\text{I}_2] = 0.500 \text{ mol/L} - x = 0.500 \text{ mol/L} - 0.393 \text{ mol/L} = 0.107 \text{ mol/L}$$

$$[\text{HI}] = 2x = (2)0.393 \text{ mol/L} = 0.786 \text{ mol/L}$$



## Appendix 4.3: Solving for $K_{\text{eq}}$ Using the BIR/PEC Accounting Method

The BIR/PEC accounting method is used in finding  $K_{\text{eq}}$ . It is optimally used when not all substances are given at equilibrium.

<b>B</b>	Balanced equation	
<b>I</b>	Initial (moles)	What you begin with before anything happens.
<b>R/P</b>	Reacted or Produced (moles)	Derived from the coefficients. Use ratio and proportion.
<b>E</b>	Equilibrium (moles)	The quantities of each substance at equilibrium. Reactants are subtracted from Initial. Products are added to Initial.
<b>C</b>	Concentration (mol/L)	The number of moles divided by the total volume.

### Question 1

Reactants A and B are mixed in a 1.00 L container, each with initial amounts of 0.80 mol. They react to produce C and D, so that

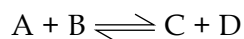

At equilibrium, the amounts of C and D are found to be 0.60 mol. Find  $K_{\text{eq}}$ .

*Answer:*

<b>B</b>	A	+	B	$\rightleftharpoons$	C	+	D
<b>I</b>	0.80 mol		0.80 mol		0 mol		0 mol
<b>R or P</b>	-0.60 mol		-0.60 mol		+0.60 mol		+0.60 mol
<b>E</b>	0.20 mol		0.20 mol		<b>0.60 mol</b>		<b>0.60 mol</b>
<b>C</b>	0.20 mol/1 L =[0.20]		0.20 mol/1 L =[0.20]		0.60 mol/1 L =[0.60]		0.60 mol/1 L =[0.60]

$$K_{\text{eq}} = \frac{[\text{C}][\text{D}]}{[\text{A}][\text{B}]} = \frac{[0.60][0.60]}{[0.20][0.20]} = \frac{0.36}{0.04} = 9$$

Appendix 4.3: Solving for  $K_{\text{eq}}$  Using the BIR/PEC Accounting Method (continued)**Question 2**

In a lab investigation, 2.00 mol of sulphur dioxide ( $\text{SO}_2$ ) and 3.0 mol of nitrogen dioxide ( $\text{NO}_2$ ) are mixed in a 2.00 L container and reacted. Once equilibrium is reached, the container is found to have 0.50 mol of sulphur trioxide ( $\text{SO}_3$ ). Calculate the value of  $K_{\text{eq}}$  for this reaction.

Answer:

<b>B</b>	$\text{SO}_{2(\text{g})}$	+	$\text{NO}_{2(\text{g})}$	$\rightleftharpoons$	$\text{SO}_{3(\text{g})}$	+	$\text{NO}_{(\text{g})}$
<b>I</b>	2.00 mol		3.00 mol		0 mol		0 mol
<b>R or P</b>	-0.50 mol		-0.50 mol		+0.50 mol		+0.50 mol
<b>E</b>	1.50 mol		2.50 mol		0.50 mol		0.50 mol
<b>C</b>	$1.50/2 = [0.75]$		$2.50/2 = [1.25]$		$0.50/2 = [0.25]$		$0.50/2 = [0.25]$

$$K_{\text{eq}} = \frac{[\text{SO}_3][\text{NO}]}{[\text{SO}_2][\text{NO}_2]} = \frac{[0.25][0.25]}{[0.75][1.25]} = \frac{0.0625}{0.9375} = 0.067$$

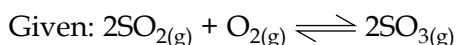
**Question 3**

Initially, 2.00 mol of  $\text{SO}_2$ , 1.00 mol of  $\text{O}_2$ , and 0.100 mol of  $\text{SO}_3$  are all mixed in a 15.0 L reaction container. After the reaction reaches equilibrium, 0.200 mol of  $\text{O}_2$  are found to remain. Calculate the value of the equilibrium constant.

Answer:

<b>B</b>	$2\text{SO}_{2(\text{g})}$	+	$\text{O}_{2(\text{g})}$	$\rightleftharpoons$	$2\text{SO}_{3(\text{g})}$
<b>I</b>	2.00 mol		1.00 mol		0.100 mol
<b>R or P</b>	-1.60 mol		-0.80 mol		+1.60 mol
<b>E</b>	0.40 mol		0.200 mol		1.70 mol
<b>C</b>	$0.40/15 = [0.0267]$		$0.20/15 = [0.0133]$		$1.70/15 = [0.113]$

$$K_{\text{eq}} = \frac{[\text{SO}_3]^2}{[\text{SO}_2]^2[\text{O}_2]} = \frac{[0.113]^2}{[0.0267]^2[0.0133]} = \frac{0.0128}{0.0000095} = 1350$$

## Appendix 4.4: Equilibrium Problems

### Problems

1. For the reaction  $\text{N}_{2(g)} + \text{O}_{2(g)} \rightleftharpoons 2\text{NO}_{(g)}$ , an analysis of the equilibrium mixture in a 1.00 L flask gives the following results: nitrogen 0.50 mol, oxygen 0.50 mol, and nitrogen monoxide 0.020 mol. Calculate  $K_{\text{eq}}$  for the reaction.
2. Hydrogen sulphide is a pungent, poisonous gas. At 1400 K, an equilibrium mixture was found to contain 0.013 mol/L hydrogen, 0.18 mol/L hydrogen sulphide, and an undetermined amount of sulphur in the form of  $\text{S}_{2(g)}$ . If the value of  $K_{\text{eq}}$  is  $2.4 \times 10^{-4}$ , what concentration of  $\text{S}_{2(g)}$  is present at equilibrium at this temperature?

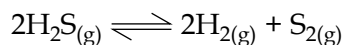

3. The following reaction increases the proportion of hydrogen gas for use as a fuel.

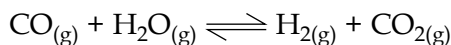

This reaction has been studied at different temperatures to find the optimum conditions. At 700 K, the equilibrium constant is 8.3. Suppose that you start with 1.00 mol of  $\text{CO}_{(g)}$  and 1.00 mol of  $\text{H}_2\text{O}_{(g)}$  in a 5.00 L container. What amount of each substance will be present in the container when the gases are at equilibrium at 700 K?

### Solutions

1.  $K_{\text{eq}} = 0.0016$
2.  $[\text{S}_{2(g)}] = 0.046 \text{ mol/L}$
3.  $[\text{CO}_{(g)}] = 0.020 \text{ mol/L}$   
 $[\text{H}_2\text{O}_{(g)}] = 0.020 \text{ mol/L}$   
 $[\text{H}_{2(g)}] = 0.18 \text{ mol/L}$   
 $[\text{CO}_{2(g)}] = 0.18 \text{ mol/L}$

## Appendix 4.5: Chemical Equilibrium: Lab Activity

---

### Introduction

Chemical reactions occur in order to approach a state of chemical equilibrium. The equilibrium state can be characterized by specifying its equilibrium constant (i.e., by indicating the numerical value of the mass action expression when the system is at equilibrium).

### Purpose

In this experiment, you will determine the value of the equilibrium constant for the following reaction:

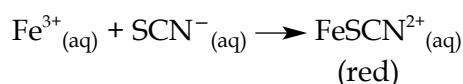

### Procedure

1. Thoroughly clean six small test tubes, rinse with distilled water, and drain. Add 5 mL of 0.0020 mol/L sodium thiocyanate (NaSCN) solution to each of these test tubes.
2. To the first test tube, add 5 mL of 0.20 mol/L iron(III) nitrate ( $\text{Fe}(\text{NO}_3)_3$ ) solution. This tube will serve as the standard.
3. Proceed as follows with the remaining test tubes:
  - Add 10 mL of 0.20 mol/L iron(III) nitrate solution to a graduated cylinder, fill the cylinder to 25 mL with distilled water, and stir thoroughly to mix. Pour 5 mL of the resulting diluted solution (0.080 mol/L iron(III),  $\text{Fe}^{3+}$ ) into test tube 2.
  - Discard all but 10 mL of the diluted solution in the graduated cylinder. Refill the cylinder with distilled water to 25 mL, and stir thoroughly. Add 5 mL of the resulting solution (0.032 mol/L  $\text{Fe}^{3+}$ ) to test tube 3.
  - Discard all but 10 mL of the solution in the cylinder, and again dilute to 25 mL. Continue this procedure until you have added to each successive test tube 5 mL of progressively more dilute iron(III) ( $\text{Fe}^{3+}$ ) solution.
4. To determine the  $[\text{FeSCN}^{2+}]$  in each test tube, determine the percent transmission of each test tube using a colorimeter or spectrometer set to the wavelength  $\lambda = 460 \text{ nm}$ . Set the transmission of the blank to 100%. Then determine the percent transmission of test tubes 1 to 6.

## Appendix 4.5: Chemical Equilibrium: Lab Activity (continued)

**Data**Optical density (absorbance) =  $-\log$  (percent transmission)

	Percent Transmission	Optical Density (Absorbance)
Test tube 1	_____	_____
Test tube 2	_____	_____
Test tube 3	_____	_____
Test tube 4	_____	_____
Test tube 5	_____	_____
Test tube 6	_____	_____

**Results**

Test Tube	Initial Concentrations		Equilibrium Concentrations			K
	[Fe <sup>3+</sup> ]	[SCN <sup>-</sup> ]	[FeSCN <sup>2+</sup> ]	[Fe <sup>3+</sup> ]	[SCN <sup>-</sup> ]	
1						
2						
3						
4						
5						
6						

**Note:**

When calculating equilibrium concentrations, assume that all the initial thiocyanate ion (SCN<sup>-</sup>) in test tube 1 has been converted to the thiocyanatoiron(III) ion (FeSCN<sup>2+</sup>). This provides the [FeSCN<sup>2+</sup>] in test tube 1.

The [FeSCN<sup>2+</sup>] in the remaining test tubes can be determined using the idea that *the concentration of a coloured substance is directly proportional to the optical density (absorbance)*.

Appendix 4.5: Chemical Equilibrium: Lab Activity (continued)

---

When calculating initial concentrations, assume that iron(III) nitrate ( $\text{Fe}(\text{NO}_3)_3$ ) and sodium thiocyanate ( $\text{NaSCN}$ ) are completely dissociated. Remember also that mixing two solutions dilutes both of them. Equilibrium concentrations of iron(III) ion ( $\text{Fe}^{3+}$ ) and thiocyanate ion ( $\text{SCN}^-$ ) are obtained by subtracting thiocyanatoiron(III) ion ( $\text{FeSCN}^{2+}$ ) formed from the initial iron(III) ion and thiocyanate ion concentrations. Calculate the value of the equilibrium constant  $K$  for test tubes 2 to 6.

**Questions**

1. What assumptions are made in this experiment?
2. Why can you **not** determine a value for an equilibrium constant  $K$  for test tube 1?
3. Using the average value of  $K$ , determine  $[\text{SCN}^-]$  in test tube 1 at equilibrium.
4. Approximately how complete is this reaction? Explain.
5. Compare and contrast ions in solution with gas molecules.
6. Why is this particular equilibrium suitable for study in our laboratory?

## Appendix 4.6A: An Analogy for an Equilibrium Reaction: Lab Activity

### Purpose

- To illustrate the experimental conditions necessary to have a system of experimental equilibrium.
- To illustrate the effect of applying stress to a system in equilibrium.
- To illustrate graphically the changes that lead to the establishment of equilibrium.

### Apparatus/Materials

two 25 mL graduated cylinders  
 two drinking straws of different diameters  
 graph paper

### Procedure

1. Copy the table below into your lab book and record your data as you perform the experiment.

#### Data Table

Number of Transfers	Volume of Water Cylinder A (mL)	Volume of Water Cylinder B (mL)
0	25	0
1		
2		
3		
etc.		

2. Label a 25 mL cylinder as **cylinder A** (reactants) and fill it to the 25 mL mark with water. Label a second 25 mL cylinder as **cylinder B** (products).
3. Working with your partner, transfer water simultaneously from one cylinder to the other, using straws of different diameters. Lower the straws into the respective cylinders, and when each straw touches the bottom of the cylinder, place your index finger over the open end of the straw. Transfer the water collected to the other cylinder and allow the straw to drain.
4. Remove each straw and record the volume of water in each cylinder, being careful to read the meniscus to the nearest 0.1 mL.
5. Return the straws to their original cylinders and repeat the process, recording the volumes after each transfer.
6. After three successive transfers result in no other change in volume, add 5 mL of water to cylinder A. Record the volume in each cylinder. Then resume the water transfer until three successive transfers again result in identical volumes.

**Appendix 4.6A: An Analogy for an Equilibrium Reaction: Lab Activity (continued)**

---

**Calculations**

Plot the volume of water for both cylinder A and cylinder B on the  $y$ -axis of the same piece of graph paper against the number of transfers on the  $x$ -axis. Join each set of points with a smooth curve.

**Questions**

1. Describe, based on your graph, the changes in volume (analogous to concentration) and corresponding rates that occur in each curve up to the point where the extra 5 mL was added.
2. Describe the change that occurs in the curve for cylinder A at the point where the 5 mL of water is added.
3. What significance can be attributed to
  - a) the point where the two curves meet?
  - b) the first flat portions of the two curves?
  - c) the second flat portions of the curves?
4. What change in the final volume of water in cylinder B results from the addition of the 5 mL of water to cylinder A?
5. What is the evidence that equilibrium has been established if
  - a) the data for the water transfers are observed?
  - b) the plotted data are observed?
6. Why is this particular system called *closed*?
7. The additional 5 mL of water constitutes a “stress” on the system.
  - a) What analogous stress would be involved if the system really represented a chemical reaction in equilibrium?
  - b) Name two other stresses that could be imposed on a chemical system.
8. What factor controls the relative volumes of water in each cylinder at equilibrium in this exercise?
9. Consult with other members of your class to see whether their graphs are similar to, or different from, yours. Account for any differences you find.
10. In a real chemical system, what factor would control the relative concentrations of reactants and products present at equilibrium?



## Appendix 4.6B: An Analogy for an Equilibrium Reaction: Lab Activity (Teacher Notes)

### Background

For this experiment, it is **very important** to use two straws of different diameters so that the equilibrium position is not half of the initial volume. It is also helpful to use one coloured solution and one colourless solution.

Experimental results will depend upon the types of straws used and the starting cylinder of each straw. The graphs below illustrate actual experimental data using the procedure described in Appendix 4.6A.

**Note:** One coloured solution and one colourless solution could be used.

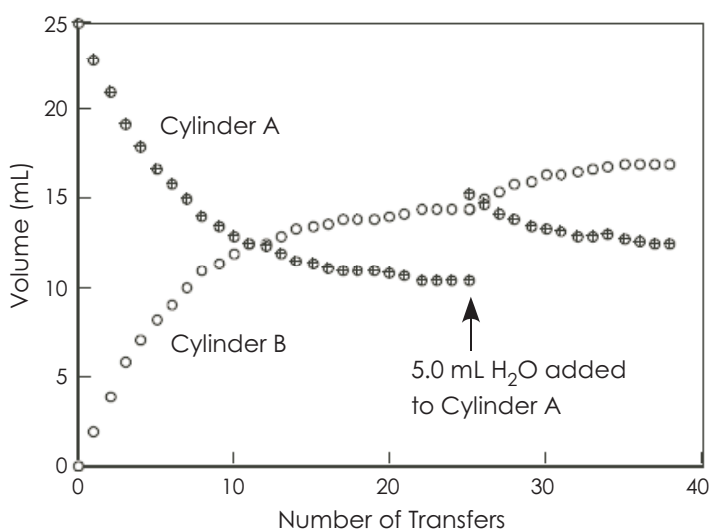
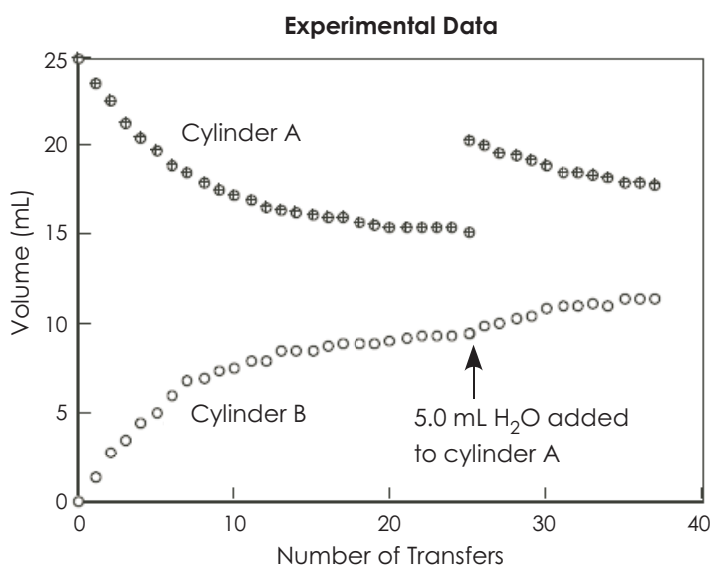

## Appendix 4.6C: An Analogy for an Equilibrium Reaction: Lab Report Checklist

---

Does the lab report include the following components?

### Purpose

### Observations (from Procedures)

#### Qualitative Data

- Describe the properties of water and the straws.
- In general, what happened to the volume of water in the two graduated cylinders?
- When was equilibrium achieved?
- What happened to the system when the volume of cylinder A was changed?
- At what point was equilibrium re-established?

#### Quantitative Data Table

#### Calculations (Graph)

- axes labelled
- title
- points joined with a smooth curve
- descriptions of
  - the system's initial volumes (for cylinders A and B)
  - how we know from the graph that equilibrium is achieved
  - the change in volume of cylinder A due to the stress
  - the change in volume of cylinder B due to the stress

#### Conclusions

- What happened when a stress was added to the system?
- What happens to the slope of the graph when the system achieves equilibrium?

#### Answers to Questions

#### Sources of Error

---

**Appendix 4.7: Equilibrium and Le Châtelier's Principle (Pre-lab)**

---

**Questions**

1. Define *equilibrium*.
2. State Le Châtelier's principle.
3. Consider the following reaction.

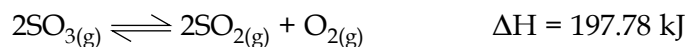

For this reaction, indicate how the amount of  $\text{SO}_{2(g)}$  present at equilibrium would be affected by

- a) adding  $\text{SO}_3$
- b) raising the temperature
- c) decreasing the volume
- d) removing some  $\text{O}_2$
- e) adding some  $\text{SO}_2$
- f) adding a catalyst
- g) removing some  $\text{SO}_3$

**Appendix 4.8A: Qualitative Equilibrium: Lab Activity**

---

**Introduction**

A standard laboratory example for demonstrating the effect of changing concentrations on the equilibrium positions is shown below:

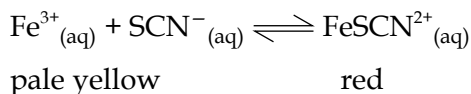

The position of equilibrium can be determined from the colour of the solution. When the iron(III) nitrate and potassium thiocyanate solutions are mixed, the colour of the mixture is orange at equilibrium. If the equilibrium lies to the right, the solution is a dark red colour. If the equilibrium lies to the left, the solution is a pale yellow colour.

**Apparatus/Materials**

well plate  
0.020 mol/L iron(III) nitrate ( $\text{Fe}(\text{NO}_3)_3$ )  
0.002 mol/L potassium thiocyanate (KSCN)  
1.0 mol/L sodium hydroxide (NaOH)  
toothpicks

**Procedure**

1. In each of four wells, add 5 drops of iron(III) nitrate and 5 drops of potassium thiocyanate. Mix each solution with a toothpick.
2. Do not alter the first well. It will act as your control.
3. To the second well, add 10 drops of sodium hydroxide. Record your observations.
4. To the third well, add 10 drops of iron(III) nitrate. Record your observations.
5. Add 10 drops of potassium thiocyanate to the fourth well. Record your observations.

**Observations and Analysis**

Use Le Châtelier's principle to explain the results from steps 3 to 5 of the procedure.

**Appendix 4.8B: Qualitative Equilibrium: Lab Activity (Teacher Notes)**

Consider the demonstration below:

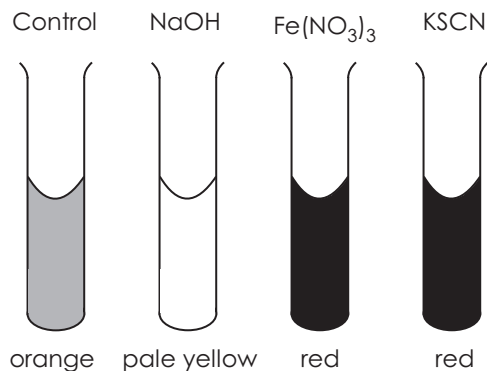

If salts contain  $\text{Fe}^{3+}$ ,  $\text{SCN}^-$ , or both, the colour of the solution becomes a deeper red. This suggests a shift in equilibrium to the right. To use up some of the added reactant, the rate of the forward reaction increases, thereby increasing the concentration of  $\text{FeSCN}^{2+}$  and establishing a new equilibrium position.

When NaOH is added to the system, the solution turns to a pale yellow. The hydroxide ions from the NaOH combine with iron(III) ions to produce an insoluble complex of iron(III) hydroxide. Precipitating out the iron ions reduces the iron ion concentration. The system responds to the change by favouring the reverse reaction and replacing some of the “lost” iron. A change to a pale yellow colour indicates a shift in the equilibrium to the left and a reduction in the  $\text{FeSCN}^{2+}$  ion concentration.

## Appendix 4.9: Disrupting Equilibrium Systems: Lab Activity

---

### Introduction

Le Châtelier's principle describes the effect that applying various types of stresses will have on the position of equilibrium – whether or not it will shift to increase or decrease the concentration(s) of products in the equilibrium system. These stresses include changes in factors such as concentrations of reactants or products, temperature of the system, and, for reactions involving gases, pressure.

Some investigations are done with systems in a water solution. In these systems, where gases are not involved, the volume of the system is generally defined by the volume of the solution, and pressure is of little or no consequence.

### Purpose

The purpose of this experiment is to let you observe for yourself what Le Châtelier's principle means.

### Apparatus

- fume hood
- 50 mL beaker
- well plate (12 wells)
- scoopula
- 10 mL graduated cylinder
- eyedropper pipettes
- hot plate
- ice bath

### Materials

- distilled water
- solid cobalt(II) chloride ( $\text{CoCl}_2 \cdot 6\text{H}_2\text{O}_{(s)}$ )
- solid calcium chloride ( $\text{CaCl}_{2(s)}$ )
- 0.1 mol/L silver nitrate ( $\text{AgNO}_3$ )
- 12 mol/L hydrochloric acid (HCl)
- ethanol

## Appendix 4.9: Disrupting Equilibrium Systems: Lab Activity (continued)

**Procedure**

1. Gather all equipment.
2. Measure out 10 mL of ethanol and place it in the 50 mL beaker.
3. Place several pieces of the solid cobalt(II) chloride in one of the wells in your well plate. Note both its colour and the formula for the compound, as shown on the label of the stock bottle.
4. Add 4 or 5 crystals of the cobalt(II) chloride to the ethanol in the beaker until a blue solution results. Add more crystals, if necessary.
5. Using an eyedropper pipette, transfer one-fifth of the blue solution to four of the wells in the well plate. Be sure to leave a small amount in the beaker.
6. To one of the wells from step 5, add 5 drops of distilled water, one drop at a time. Record your observations after each drop. Repeat this step in two more wells so that all three of them exhibit the same colour.
7. Take your well plate to the fume hood.  
Use the eyedropper pipette provided in the acid bottle of 12 mol/L hydrochloric acid and carefully add one drop at a time until you have added 5 drops to the first well from step 6.
8. To the second well from step 6, add 2 small lumps of solid calcium chloride.
9. To the third well from step 6, add 10 drops of 0.1 mol/L silver nitrate.
10. Retain the solution in the fourth well to use for comparison purposes.
11. To the remaining solution in the beaker, add just enough distilled water to get a purple colour that is about halfway between the blue and pink shades. Place the beaker on a hot plate and warm the beaker until a colour change occurs. Make sure you do not let the ethanol come to a boil.
12. Chill the beaker in an ice bath to see if the colour change in step 11 is reversible.

**Warning:**

Hydrochloric acid is caustic and corrosive. Avoid contact, and immediately rinse all spills with copious amounts of water.

**Caution:**

Silver nitrate will stain your skin and clothing.

## Appendix 4.9: Disrupting Equilibrium Systems: Lab Activity (continued)

## Observations

Before Reactions	
	Colour
Distilled water	
$\text{CoCl}_2 \cdot 6\text{H}_2\text{O}_{(s)}$	
$\text{CaCl}_{2(s)}$	
0.1 mol/L $\text{AgNO}_3$	
12 mol/L HCl	
Ethanol	

After Reactions	
	Colour
Add distilled water ( $\text{H}_2\text{O}$ )	
Add hydrochloric acid (HCl)	
Add calcium chloride ( $\text{CaCl}_{2(s)}$ )	
Add silver nitrate ( $\text{AgNO}_3$ )	
Add heat	
Remove heat	

## Analysis

- The net ionic equation for the equilibrium reaction you have been investigating is

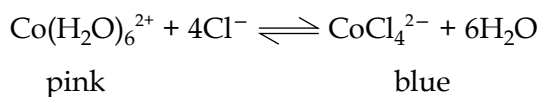

On the reagent bottle, the formula for the solid cobalt(II) chloride is  $\text{CoCl}_2 \cdot 6\text{H}_2\text{O}$ . What name do we give to compounds that have water molecules bound to their structure?



## Appendix 4.9: Disrupting Equilibrium Systems: Lab Activity (continued)

- Which cobalt complex was favoured by the addition of water in step 6 of the procedure? Use Le Châtelier's principle to explain the colour change.
- Which cobalt complex was favoured in both steps 7 and 8 of the procedure? What ion is common to both of the reagents that caused the colour changes? Use Le Châtelier's principle to explain why the colour change occurred in each case.
- What colour was the solid you formed in step 9 of the procedure? Why must it have been this colour? To what colour did the liquid in the well turn? Which complex of cobalt was favoured? Explain. Use Le Châtelier's principle to explain why the liquid in the well underwent the colour change that you observed.
- Which cobalt complex was favoured by the addition of heat in step 11 of the procedure? Rewrite the equation for the reaction, including the energy term directly in the equation. The value of  $\Delta H$  for the process is +50 kJ/mol. Use Le Châtelier's principle and the equation that you just wrote to explain the colour changes that resulted from the heating and cooling.

**Discussion**

Provide two sources of error. If any of your results do not match what the colour change should have been, talk about it in your discussion.

**Conclusion**

State what the colour change should be – not necessarily what you saw.

"Stress"	Colour Change	Shift
Addition of H <sub>2</sub> O		
Addition of HCl		
Addition of CaCl <sub>2</sub>		
Addition of AgNO <sub>3</sub>		
Addition of heat		
Removal of heat		

## Appendix 4.10: Interpreting Equilibrium Graphs

The graphs below illustrate rate changes for the  $\text{NO}_2\text{-N}_2\text{O}_4$  equilibrium system. In preparing the graphs, it was assumed that the system was at equilibrium initially, then a stress was applied, and, after an instantaneous change, the system was allowed to re-establish equilibrium.

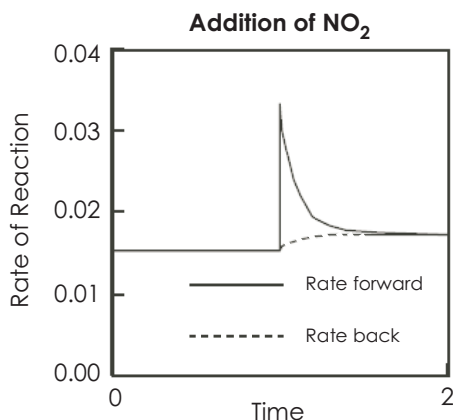
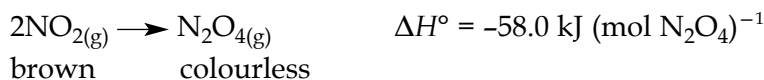

Graph A

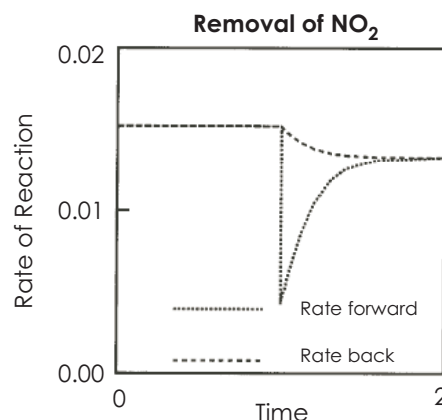

Graph B

### Graph A

Initially, the reaction is at equilibrium—both the forward and the reverse rates are equal. At the instant when more reactant  $\text{NO}_2$  is added, the forward rate increases. As the reactant is consumed in the reaction, the forward rate decreases to a constant value.

Initially, the reverse rate is unchanged. However, as more product is formed, the rate of the back reaction increases to the new constant value.

### Graph B

Initially, the reaction is an equilibrium—both the forward and reverse rates are equal. At the instant when reactant  $\text{NO}_2$  is removed, the forward rate decreases. As more  $\text{NO}_2$  is produced through the back reaction, the forward rate increases to a new constant value.

Initially, the reverse rate is unchanged. However, since product is no longer being formed at the same rate, the rate of the back reaction decreases as the amount of product decreases (and more reactant is formed).

## Appendix 4.10: Interpreting Equilibrium Graphs (continued)

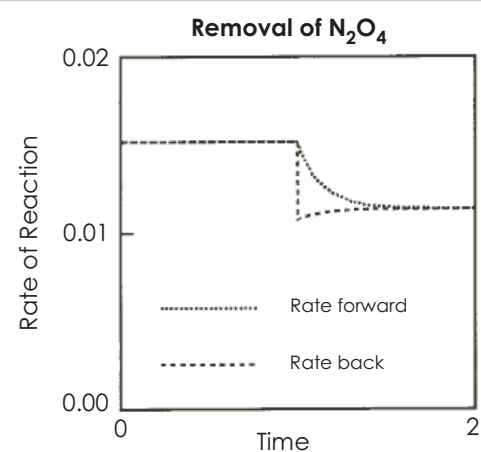
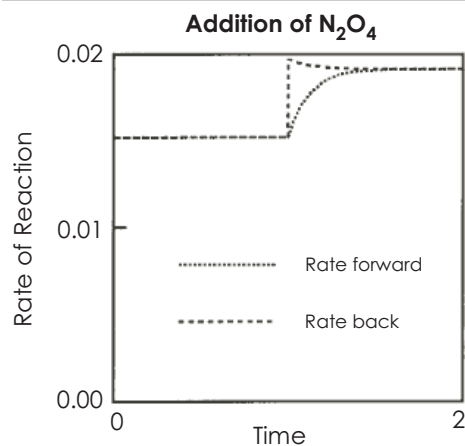
**Graph C**

At the instant when product  $N_2O_4$  is added, the reverse rate goes up. Then, as some product concentration is decreased by reaction, the reverse rate decreases until it reaches a constant value.

At the instant when product  $N_2O_4$  is added, the forward rate is unchanged. As the “reactant” concentration increases, through reaction, the forward rate increases to its new constant value.

**Graph D**

At the instant when product  $N_2O_4$  is removed, the reverse rate goes down. Then, as more product is formed by reaction, the reverse rate increases to a new constant value.

At the instant when product  $N_2O_4$  is removed, the forward rate is unchanged. Then, as more reactant is used up in producing more of the product, the forward rate decreases to a new constant value.

Appendix 4.10: Interpreting Equilibrium Graphs (continued)

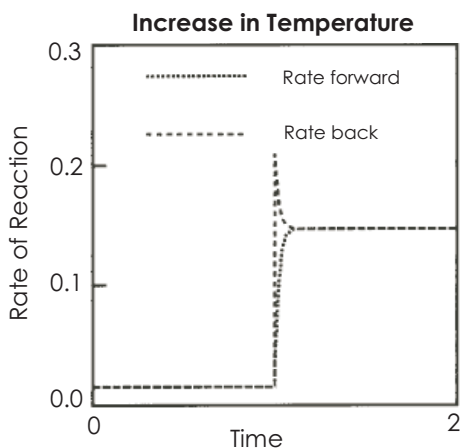

**Graph E**

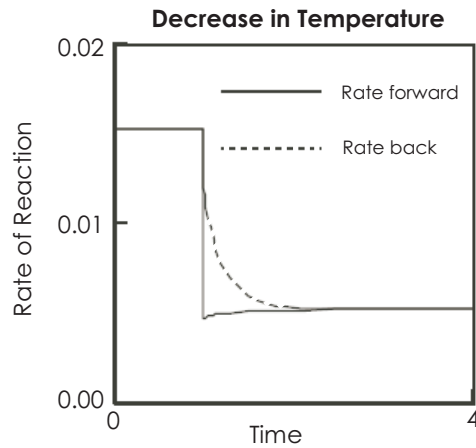

**Graph F**

**Graph E**

Initially, the system is at equilibrium—the rates of the forward and reverse reactions are equal.

When the temperature is increased, both the forward and the reverse rates increase. Because the reaction is exothermic, the reverse rate goes up more than the forward reaction does.

**Graph F**

Initially, the system is at equilibrium—the rates of the forward and reverse reactions are equal.

When the temperature is lowered, both the forward and reverse rates decrease. Because the reaction is exothermic, the reverse rate goes down less than the forward reaction does.

## Appendix 4.11: Interpreting Concentration versus Time Graphs

The graphs below illustrate concentration changes for the  $\text{NO}_2\text{-N}_2\text{O}_4$  equilibrium system. In preparing the graphs, it was assumed that the system was at equilibrium initially, then a stress was applied, and, after an instantaneous change, the system was allowed to re-establish equilibrium.

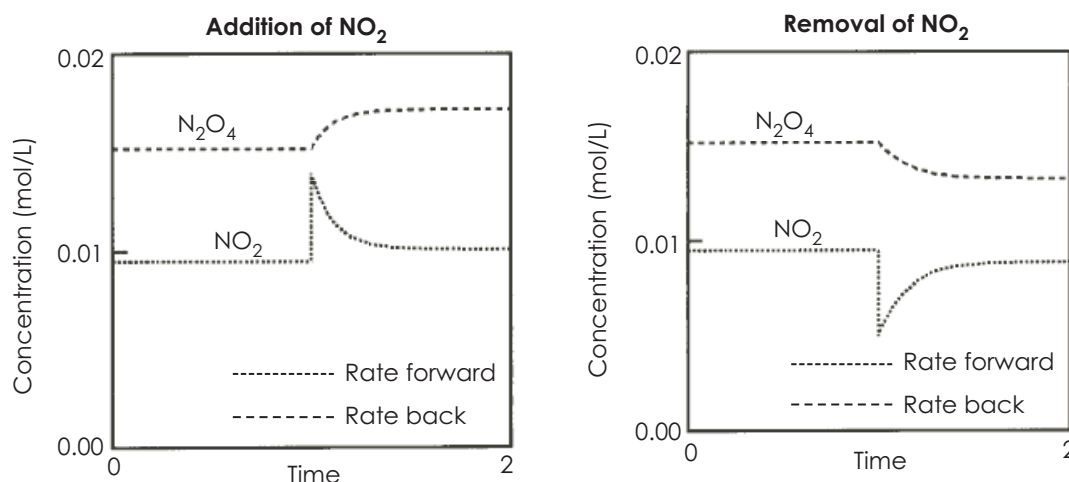

Graph A

Graph B

### Graph A

Initially, the reaction is at equilibrium—the concentrations of reactant  $\text{NO}_2$  and product  $\text{N}_2\text{O}_4$  are constant. At the instant when more reactant  $\text{NO}_2$  is added, the  $[\text{NO}_2]$  increases abruptly. As the reactant is consumed in the reaction, its concentration decreases to a constant value.

Initially,  $[\text{N}_2\text{O}_4]$  is unchanged. However, as reaction proceeds, more product is formed, and  $[\text{N}_2\text{O}_4]$  increases to a new constant value, a new equilibrium position.

### Graph B

Initially, the reaction is at equilibrium—the concentrations of reactant  $\text{NO}_2$  and product  $\text{N}_2\text{O}_4$  are constant. At the instant when more reactant  $\text{NO}_2$  is removed, the  $[\text{NO}_2]$  decreases abruptly. As more  $\text{NO}_2$  is produced through the back reaction, its concentration increases to a new constant value.

Initially,  $[\text{N}_2\text{O}_4]$  is unchanged. However, since product is no longer being formed at the same rate, its concentration decreases to a new constant value, a new equilibrium position.

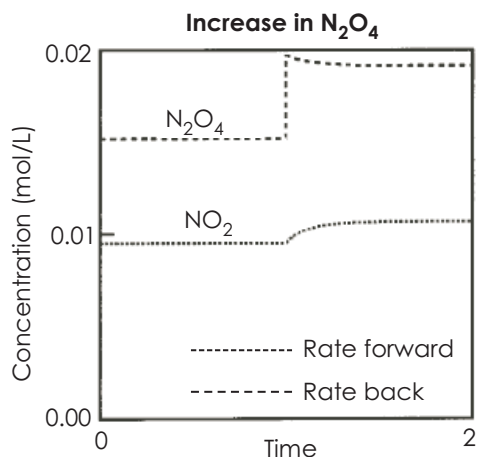
Appendix 4.11: Interpreting Concentration versus Time Graphs (*continued*)

Graph C

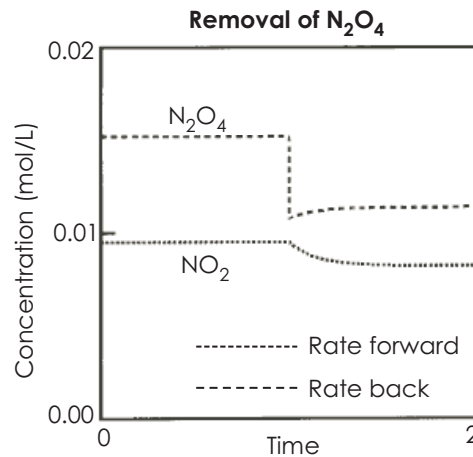

Graph D

**Graph C**

At the instant when product  $\text{N}_2\text{O}_4$  is added,  $[\text{N}_2\text{O}_4]$  goes up abruptly. Then, as the product concentration is decreased by reaction, the reverse rate decreases until it reaches a constant value.

At the instant when product  $\text{N}_2\text{O}_4$  is added, the forward rate is unchanged. As the “reactant” concentration increases, through reaction, the forward rate increases to its new constant value.

**Graph D**

At the instant when product  $\text{N}_2\text{O}_4$  is removed, the reverse rate goes down. Then, as more product is formed by reaction, the reverse rate increases to a new constant value.

At the instant when product  $\text{N}_2\text{O}_4$  is removed, the forward rate is unchanged. Then, as more reactant is used up in producing more of the product, the forward rate decreases to a new constant value.

## Appendix 4.11: Interpreting Concentration versus Time Graphs (continued)

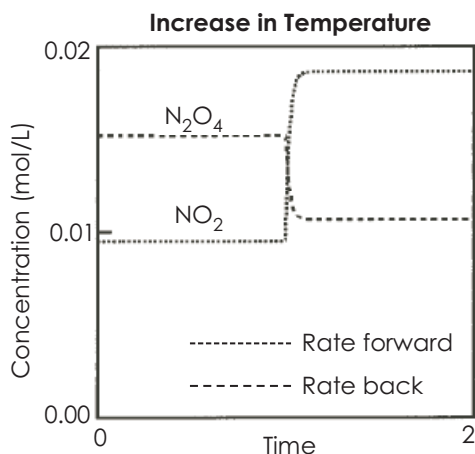

Graph E

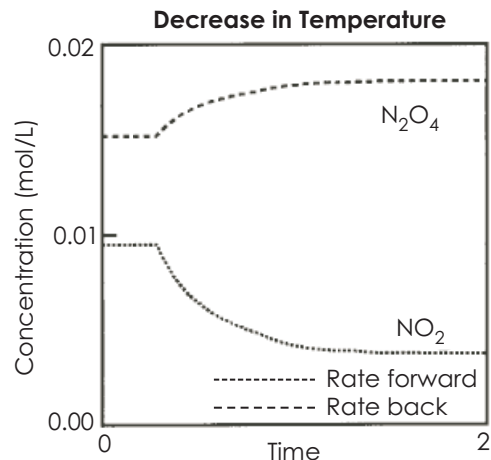

Graph F

**Graph E**

Initially, the system is at equilibrium –  $[\text{NO}_2]$  and  $[\text{N}_2\text{O}_4]$  are constant.

The reaction is exothermic –  $K_{\text{eq}}$  decreases when the temperature increases. When the temperature is increased, the system is not at equilibrium under the new conditions.  $[\text{NO}_2]$  increases to establish a new equilibrium.

**Graph F**

Initially, the system is at equilibrium –  $[\text{NO}_2]$  and  $[\text{N}_2\text{O}_4]$  are constant.

The reaction is exothermic –  $K_{\text{eq}}$  increases when the temperature decreases. When the temperature is decreased, the system is not at equilibrium under the new conditions.  $[\text{N}_2\text{O}_4]$  increases to establish a new equilibrium.





**TOPIC 5:**  
**ACIDS AND BASES**

---



## Topic 5: Acids and Bases

- C12-5-01** Outline the historical development of acid-base theories.  
Include: the Arrhenius, Brønsted-Lowry, and Lewis theories
- C12-5-02** Write balanced acid-base chemical equations.  
Include: conjugate acid-base pairs and amphoteric behaviour
- C12-5-03** Describe the relationship between the hydronium and hydroxide ion concentrations in water.  
Include: the ion product of water,  $K_w$
- C12-5-04** Perform a laboratory activity to formulate an operational definition of  $pH$ .
- C12-5-05** Describe how an acid-base indicator works in terms of colour shifts and Le Châtelier's principle.
- C12-5-06** Solve problems involving  $pH$ .
- C12-5-07** Distinguish between strong and weak acids and bases.  
Include: electrolytes and non-electrolytes
- C12-5-08** Write the equilibrium expression ( $K_a$  or  $K_b$ ) from a balanced chemical equation.
- C12-5-09** Use  $K_a$  or  $K_b$  to solve problems for  $pH$ , percent dissociation, and concentration.
- C12-5-10** Perform a laboratory activity to determine the concentration of an unknown acid or base, using a standardized acid or base.
- C12-5-11** Predict whether an aqueous solution of a given ionic compound will be acidic, basic, or neutral, given the formula.

**Suggested Time: 14 hours**

**Topic 5:  
Acids and  
Bases**

**SPECIFIC LEARNING OUTCOMES**

**C12-5-01:** Outline the historical development of acid-base theories.

Include: the Arrhenius, Brønsted-Lowry, and Lewis theories

**C12-5-02:** Write balanced acid-base chemical equations.

Include: conjugate acid-base pairs and amphoteric behaviour

(2 hours)

SLO: C12-5-01  
SLO: C12-5-02

**SUGGESTIONS FOR INSTRUCTION**

**Entry-Level Knowledge**

In Grade 10 Science (S2-2-08), students experimented to classify acids and bases according to their characteristics. Students were introduced to hydrochloric, sulphuric, and nitric acids, as well as to some bases, such as sodium hydroxide and calcium hydroxide. In Grade 11 Chemistry (Topic 5: Organic Chemistry), students studied organic acids, such as formic and acetic acids.

**Assessing Prior Knowledge**

Check for students' understanding of prior knowledge, and review concepts as necessary. Prior knowledge can be reviewed and/or assessed by using any of the KWL strategies (e.g., Concept Map, Knowledge Chart, Think-Pair-Share – see *SYSTH*, Chapter 9).

**TEACHER NOTES**

**Common Acids and Bases**

Review common acids and bases, including those with which students are familiar. Brainstorming or using a KWL strategy would provide students with an opportunity to describe their prior knowledge. Common examples of acids include lactic acid in sour milk, butyric acid in rancid butter, citric acid in citric fruit, ascorbic acid as vitamin C, and acetylsalicylic acid (ASA) tablets. Example of bases include ammonia as a household cleaner and sodium hydroxide as an oven cleaner.

**General Learning Outcome Connections**

**GLO A1:** Recognize both the power and limitations of science as a way of answering questions about the world and explaining natural phenomena.

**GLO A2:** Recognize that scientific knowledge is based on evidence, models, and explanations, and evolves as new evidence appears and new conceptualizations develop.

**GLO A4:** Identify and appreciate contributions made by women and men from many societies and cultural backgrounds that have increased our understanding of the world and brought about technological innovations.

**GLO D3:** Understand the properties and structures of matter, as well as various common manifestations and applications of the actions and interactions of matter.

**SKILLS AND ATTITUDES OUTCOME**

**C12-0-U1:** Use appropriate strategies and skills to develop an understanding of chemical concepts.

*Examples: analogies, concept frames, concept maps, manipulatives, particulate representations, role-plays, simulations, sort-and-predict frames, word cycles . . .*

**Theories of Acids and Bases**

Current understanding and definitions of acids and bases are based on the historical contributions of chemists such as Svante Arrhenius, Johannes Brønsted, Thomas Lowry, and Gilbert Newton Lewis.

Each successive definition of acids and bases becomes more inclusive until finally the definition proposed by Lewis (Lewis Dot Diagrams) becomes so general that any reaction in which a pair of electrons is transferred becomes an acid-base reaction.

**The Arrhenius Theory**

Swedish scientist Svante Arrhenius (1859–1927) proposed a theory explaining the nature of acids and bases according to their structure and the ions produced when they dissolve in water.

- **Acids:** *Acids* are any substances that dissociate to produce *hydrogen ions* ( $\text{H}^+$ ) when dissolved in water.

*Examples:*

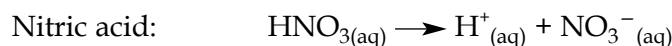
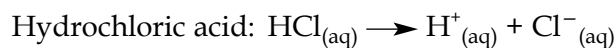

- **Bases:** *Bases* are any substances that dissociate to produce *hydroxide ions* ( $\text{OH}^-$ ) when dissolved in water.

*Examples:*

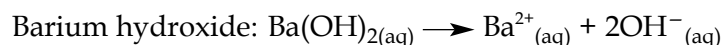
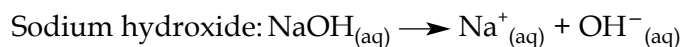

A limitation of the Arrhenius theory is that it does not account for reactions between substances that are acidic or basic but do not have a hydrogen or hydroxide ion. A few troublesome species such as carbon dioxide (which lacks the hydrogen ion) and ammonia (which lacks the hydroxide ion) were explained by Arrhenius as first reacting with water.

*Examples:*

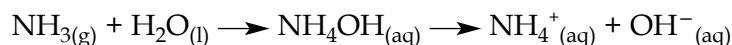
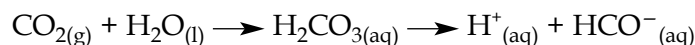

## Topic 5: Acids and Bases

### SPECIFIC LEARNING OUTCOMES

**C12-5-01:** Outline the historical development of acid-base theories.

Include: the Arrhenius, Brønsted-Lowry, and Lewis theories

**C12-5-02:** Write balanced acid-base chemical equations.

Include: conjugate acid-base pairs and amphoteric behaviour

(continued)

### The Brønsted-Lowry Theory

Danish chemist Johannes Brønsted (1879–1947) and English chemist Thomas Lowry (1874–1936) simultaneously proposed a new theory, called the Brønsted theory, or the Brønsted-Lowry theory. This theory relates acid-base characteristics to proton transfer, a process that includes more reactions than the definition of acids and bases proposed by Arrhenius.

According to the Brønsted-Lowry definition, a substance such as carbon dioxide ( $\text{CO}_{2(g)}$ ) can now be clearly seen as an acid that picks up a proton when bubbled through water, according to the following reaction.

Example:

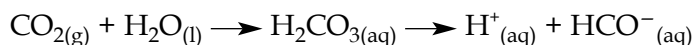

- **Acids:** Acids are substances that increase the hydronium ( $\text{H}_3\text{O}^+$ ) ion concentration. Thus, acids are *proton donors*.

Examples:

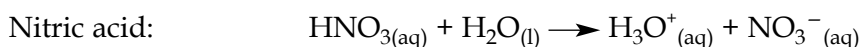
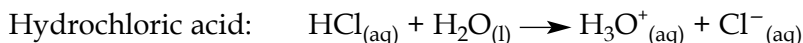

When any one of the substances HCl,  $\text{HNO}_3$ ,  $\text{CH}_3\text{COOH}$ ,  $\text{CO}_2$ , or  $\text{H}_2\text{SO}_4$  is added to water, the hydronium ion concentration is increased. Hence, the substances are considered acids.

- **Bases:** Bases are substances that increase the hydroxide ( $\text{OH}^-$ ) ion concentration. Thus, bases are *proton acceptors*.

Examples:

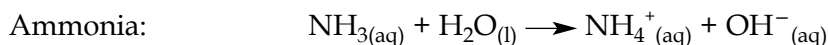

When any one of the substances NaOH,  $\text{Ca}(\text{OH})_2$ , CaO, MgO, or  $\text{NH}_3$  is added to water, the hydroxide ion concentration is increased. Hence, the substances are considered *bases*.

**SKILLS AND ATTITUDES OUTCOME**
**C12-0-U1:** Use appropriate strategies and skills to develop an understanding of chemical concepts.

*Examples: analogies, concept frames, concept maps, manipulatives, particulate representations, role-plays, simulations, sort-and-predict frames, word cycles . . .*

In any acid-base reaction, a conjugate acid and a base pair are established.

*Example:*

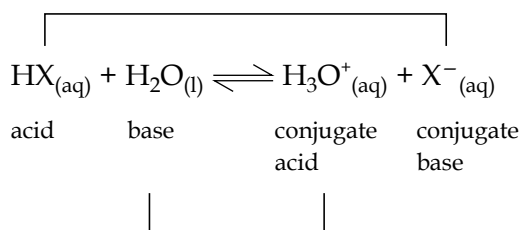

Substances that can act as both acids and bases, such as water, are said to be *amphoteric*.

Acids are classified by the number of hydrogen ions available to be donated. *Monoprotic acids* have one hydrogen ion to donate. *Polyprotic acids* have two or more hydrogen ions to donate. All polyprotic acids donate one hydrogen ion at a time. An inspection of an acid  $K_a$  table will show that a diprotic acid such as sulphuric acid will have 2  $K_a$  values for each successive dissociation.

*Examples:*



**Note:** The Brønsted-Lowry definition of acids and bases is the most useful for Grade 12 Chemistry and should be the one emphasized. The Lewis definition involves the transfer of electrons and can become quite complex.

**The Lewis Theory**

American chemist Gilbert Newton (G. N.) Lewis (1875–1946) proposed in 1932 that an acid accepts a pair of electrons during a chemical reaction, while a base donates a pair of electrons.

The significance of the Lewis concept is that it is more general than any of the other definitions. Lewis acid-base reactions include many reactions that would not be included with the Brønsted-Lowry definition.

Lewis argued that the  $\text{H}^+$  ion picks up (accepts) a pair of electrons from the  $\text{OH}^-$  ion to form a new covalent bond. As a result, any substance that can act as an electron pair acceptor is a Lewis acid.

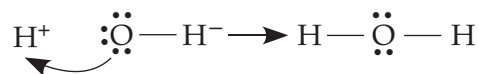

## Topic 5: Acids and Bases

### SPECIFIC LEARNING OUTCOMES

**C12-5-01:** Outline the historical development of acid-base theories.

Include: the Arrhenius, Brønsted-Lowry, and Lewis theories

**C12-5-02:** Write balanced acid-base chemical equations.

Include: conjugate acid-base pairs and amphoteric behaviour

(continued)

The pair of electrons that went into the new covalent bond were donated by the  $\text{OH}^-$ . Lewis, therefore, argued that any substance that can act as an electron pair donor is a Lewis base.

The Lewis acid-base theory does not affect the substances previously called Brønsted-Lowry bases, because any Brønsted-Lowry base must have a pair of non-bonding electrons in order to accept a proton.

However, the Lewis theory vastly expands the category previously called Brønsted-Lowry acids. Any compound that has one or more valence shell orbitals can now act as an acid. This theory explains why boron trifluoride ( $\text{BF}_3$ ) reacts instantly with ammonia ( $\text{NH}_3$ ). The non-bonding electrons on the N in ammonia are donated into an empty orbital on the boron atom to form a covalent bond, as shown below.

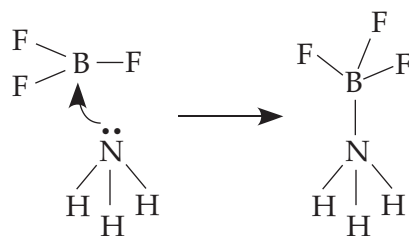

### Amphoteric Behaviour

Amino acids and proteins are amphoteric, as they both contain a basic amino group ( $-\text{NH}_2$ ) and an acid carboxyl group ( $-\text{COOH}$ ).

### Demonstration: Properties of Bases

Ask students to recall “how soap feels then they wash their hands (slippery). Then, show them that when red litmus paper touches a wet bar of soap, the litmus paper turns blue” (Dingrando, et al., *Glencoe Chemistry: Matter and Change, Teacher Wraparound Edition* 596).

### Learning Activity

Ask students to “make paper cutouts to represent the atoms of hydrogen, oxygen, and chlorine in the reaction between hydrogen chloride and water. They can use thumbtacks to attach the cutouts to a poster board or bulletin board, then physically transfer the  $\text{H}^+$  from  $\text{HCl}$  to  $\text{H}_2\text{O}$  to create  $\text{H}_3\text{O}^+$  and  $\text{Cl}^-$ ” (Dingrando, et al., *Glencoe Chemistry: Matter and Change, Teacher Wraparound Edition* 598).



**SKILLS AND ATTITUDES OUTCOME**

**C12-0-U1:** Use appropriate strategies and skills to develop an understanding of chemical concepts.

*Examples: analogies, concept frames, concept maps, manipulatives, particulate representations, role-plays, simulations, sort-and-predict frames, word cycles . . .*

---

**EAL Strategy**

Have English as an additional language (EAL) learners look up and then explain the meanings of several key English prefixes and words used in addressing learning outcomes C12-5-01 and C12-5-02: *mono-*, *di-*, *tri-*, *poly-*, *amphoteric*, *conjugate*, *monoprotic*, *polyprotic* (Dingrando, et al., *Glencoe Chemistry: Matter and Change, Teacher Wraparound Edition* 597).

**SUGGESTIONS FOR ASSESSMENT**

---

**Paper-and-Pencil Tasks**

1. Students should be able to identify conjugate acid-base pairings from a given reaction. They should also be able to write equations for the ionization of hydrogen ions for polyprotic acids.
2. Students can complete a Three-Point Approach for Words and Concepts for each of the three acid-base theories discussed (see *SYSTH* 10.22).

**Debates**

Have students perform a debate involving the Arrhenius and Brønsted-Lowry theories of acids and bases. One student would defend the Arrhenius theory, while the other would defend the Brønsted-Lowry theory.

**Visual Displays**

Students can develop a Concept Map using terms such as the following: *acidic solutions*, *acids*, *bases*, *Arrhenius theory*, *Brønsted-Lowry theory*, *Lewis theory*, *pair of electrons*, *accept*, and *donate*.

**LEARNING RESOURCES LINKS**

---



*Glencoe Chemistry: Matter and Change* (Dingrando, et al.)  
Section 19.1: Acids and Bases: An Introduction, 595  
(does not include the Lewis definition of acids and bases)

*Glencoe Chemistry: Matter and Change, Teacher Wraparound Edition* (Dingrando, et al. 596–598)

*Prentice Hall Chemistry* (Wilbraham, et al.)  
Section 19.1: Acid-Base Theories, 587

**Topic 5:  
Acids and  
Bases**

---

**SPECIFIC LEARNING OUTCOMES**

**C12-5-01:** Outline the historical development of acid-base theories.

Include: the Arrhenius, Brønsted-Lowry, and Lewis theories

**C12-5-02:** Write balanced acid-base chemical equations.

Include: conjugate acid-base pairs and amphoteric behaviour

(continued)

---

**Website**

Chemical Education Research Group, Iowa State University. "Chemistry Experiment Simulations and Conceptual Computer Animations." *Chemical Education*. <<http://group.chem.iastate.edu/Greenbowe/sections/projectfolder/simDownload/index4.html>> (22 Nov. 2012).

In the Acid-Base Equilibria section, download and unzip the following animation:  $\text{NH}_3(\text{aq})$  (Equilibrium System)

This animation shows  $\text{NH}_3$  and  $\text{H}_2\text{O}$  combining to form  $\text{NH}_4^+$  and  $\text{OH}^-$ . It also illustrates the Lewis structures for this equilibrium. The reverse reaction is also shown.

**Selecting Learning Resources**

For additional information on selecting learning resources for Grade 11 and Grade 12 Chemistry, see the Manitoba Education website at <[www.edu.gov.mb.ca/k12/learnres/bibliographies.html](http://www.edu.gov.mb.ca/k12/learnres/bibliographies.html)>.

**SKILLS AND ATTITUDES OUTCOME**

**C12-0-U1:** Use appropriate strategies and skills to develop an understanding of chemical concepts.

*Examples: analogies, concept frames, concept maps, manipulatives, particulate representations, role-plays, simulations, sort-and-predict frames, word cycles . . .*

---

**NOTES**

## Topic 5: Acids and Bases

### SPECIFIC LEARNING OUTCOMES

- C12-5-03:** Describe the relationship between the hydronium and hydroxide ion concentrations in water.  
Include: the ion product constant for water,  $K_w$
- C12-5-04:** Perform a laboratory activity to formulate an operational definition of  $pH$ .
- C12-5-05:** Describe how an acid-base indicator works in terms of colour shifts and Le Châtelier's principle.
- C12-5-06:** Solve problems involving  $pH$ .

(3 hours)

### SUGGESTIONS FOR INSTRUCTION

SLO: C12-5-03  
SLO: C12-5-04  
SLO: C12-5-05  
SLO: C12-5-06

#### Entry-Level Knowledge

In Grade 10 Science (S2-2-08), students experimented to classify acids and bases according to their characteristic properties. This included a discussion of the definition of  $pH$ , the significance of the  $pH$  table, and the use of indicators to differentiate between acidic and basic solutions. In Grade 11 Chemistry (Topic 5: Organic Chemistry), students studied organic acids, such as formic and acetic acids.

#### Assessing Prior Knowledge

Check for students' understanding of prior knowledge, and review concepts as necessary. Prior knowledge of terms can be reviewed and/or assessed by using any of the KWL strategies (e.g., Concept Map, Knowledge Chart, Think-Pair-Share, Word Cycle, Three-Point Approach, Compare and Contrast – see *SYSTH*, Chapter 9).

#### TEACHER NOTES

##### The Ion Product Constant for Water ( $K_w$ )

Pure water undergoes a small degree of ionization. In fact, only two molecules out of one billion will ionize.

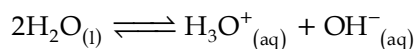

#### General Learning Outcome Connections

- GLO C2:** Demonstrate appropriate scientific inquiry skills when seeking answers to questions.
- GLO C5:** Demonstrate curiosity, skepticism, creativity, open-mindedness, accuracy, precision, honesty, and persistence, and appreciate their importance as scientific and technological habits of mind.
- GLO C8:** Evaluate, from a scientific perspective, information and ideas encountered during investigations and in daily life.
- GLO D3:** Understand the properties and structures of matter, as well as various common manifestations and applications of the actions and interactions of matter.

**SKILLS AND ATTITUDES OUTCOMES**

**C12-0-U1:** Use appropriate strategies and skills to develop an understanding of chemical concepts.

*Examples: analogies, concept frames, concept maps, manipulatives, particulate representations, role-plays, simulations, sort-and-predict frames, word cycles . . .*

**C12-0-S7:** Interpret patterns and trends in data, and infer and explain relationships.

**C12-0-S9:** Draw a conclusion based on the analysis and interpretation of data.

Include: cause-and-effect relationships, alternative explanations, and supporting or rejecting a hypothesis or prediction

The equilibrium expression for this reaction is

$$K_{\text{eq}} = K_{\text{w}} = \frac{[\text{H}_3\text{O}^+][\text{OH}^-]}{1} = [\text{H}_3\text{O}^+][\text{OH}^-]$$

**Note:** The concentration of  $\text{H}_2\text{O}$ ,  $[\text{H}_2\text{O}]$ , is equal to 1 because all pure liquids or solids have a constant concentration.

$K_{\text{w}}$  is the dissociation constant for water.

In pure water, the  $[\text{H}_3\text{O}^+]$  and  $[\text{OH}^-]$  at  $25^\circ\text{C}$  are experimentally measured as  $1 \times 10^{-7}$  mol/L. By substituting these values into the expression

$$K_{\text{w}} = [\text{H}_3\text{O}^+][\text{OH}^-]$$

we get

$$K_{\text{w}} = [1 \times 10^{-7}][1 \times 10^{-7}] = 1 \times 10^{-14}$$

**The Potency of Hydrogen (pH) Scale**

Every water solution is neutral, acidic, or basic.

- A *neutral solution* occurs when the hydronium ion concentration is equal to the hydroxide ion concentration.

$$[\text{H}_3\text{O}^+] = [\text{OH}^-]$$

- An *acidic solution* occurs when the hydronium ion concentration is greater than the hydroxide ion concentration.

$$[\text{H}_3\text{O}^+] > [\text{OH}^-]$$

- A *basic solution* occurs when the hydronium ion concentration is less than the hydroxide ion concentration.

$$[\text{H}_3\text{O}^+] < [\text{OH}^-]$$

Most concentrations of hydronium ions are very small (e.g.,  $4 \times 10^{-8}$  mol/L or 0.00000004 mol/L) and can be difficult to express. In 1909, Danish biochemist Søren P. Sørensen (1868–1939) proposed the *potency of hydrogen (pH) scale*, a scale ranging from 0 to 14 pH used to measure the acidity or alkalinity of a solution.

## Topic 5: Acids and Bases

### SPECIFIC LEARNING OUTCOMES

- C12-5-03:** Describe the relationship between the hydronium and hydroxide ion concentrations in water.  
Include: the ion product constant for water,  $K_w$
- C12-5-04:** Perform a laboratory activity to formulate an operational definition of  $pH$ .
- C12-5-05:** Describe how an acid-base indicator works in terms of colour shifts and Le Châtelier's principle.
- C12-5-06:** Solve problems involving  $pH$ .

(continued)

Actual  $pH$  and concentration are calculated by

$$pH = -\log [H_3O^+] \quad (\text{all in base } 10)$$

Similarly,

$$pOH = -\log [OH^-] \quad (\text{all in base } 10)$$

Together,

$$pH + pOH = 14$$

### Acid-Base Indicators

In Grade 10 Science, students used litmus, bromothymol blue, and phenolphthalein as acid-base indicators to test a number of solutions for  $pH$ . A great number of chemical substances can be used as indicators, which will change colour in the presence of an acid or a base. A table identifying some common acid-base indicators and their colour changes and  $pH$  range is provided in Appendix 5.1: Selected Neutralization Indicators.

Acid-base indicators are weak organic acids that change colour when the hydronium or hydroxide ion concentration is changed. Indicators (In) change colour over a given  $pH$  range. Le Chatelier's principle can be used to explain the colour change.

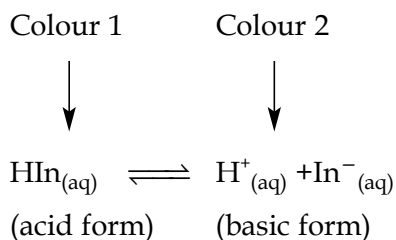

The presence of an acid increases hydrogen ion concentration, causing a shift from colour 2 toward colour 1. The presence of a base decreases hydrogen ion concentration, causing a shift from colour 1 toward colour 2.

**SKILLS AND ATTITUDES OUTCOMES**

**C12-0-U1:** Use appropriate strategies and skills to develop an understanding of chemical concepts.

*Examples: analogies, concept frames, concept maps, manipulatives, particulate representations, role-plays, simulations, sort-and-predict frames, word cycles . . .*

**C12-0-S7:** Interpret patterns and trends in data, and infer and explain relationships.

**C12-0-S9:** Draw a conclusion based on the analysis and interpretation of data.

*Include: cause-and-effect relationships, alternative explanations, and supporting or rejecting a hypothesis or prediction*

---

Change ranges are often about 2 pH units, although quite a few are less. The human eye responds more readily to some shades of colour than to others, and some substances are naturally more intensely coloured than others are, even at the same concentration.

It is important to realize that a pH change of 2 units is usually required to produce a visible colour change of a neutralization indicator. Also, the pH range necessary to produce a visible end point indication in the “on” colour type of indicator (the colour goes either to colourless or from colourless) is governed to some extent by the concentration of the indicator, while such is not the case for an indicator that possesses two distinct colours (Fischer 265).

Further explanations of how indicators work can be found online.

*Sample Website:*

Clark, Jim. “Acid-Base Indicators.” *Chemguide*. 2002, mod. Dec. 2006.

[www.chemguide.co.uk/physical/acidbaseeqia/indicators.html](http://www.chemguide.co.uk/physical/acidbaseeqia/indicators.html)

(22 Nov. 2012).

**Extension:** Show students how to select an indicator from a titration curve.

**Laboratory Activity**

Have students perform an experiment to develop an operational definition of pH (see Appendix 5.2: Acid-Base Indicators and pH: Lab Activity, Appendix 5.3A: Measuring pH: Lab Activity, and Appendix 5.3B: Measuring pH: Lab Activity [Teacher Notes]).

In this experiment, students do the following:

- Make solutions of 0.1 mol/L of a strong acid (HCl or HNO<sub>3</sub>).
- Prepare serial dilutions (using instructions provided).
- Determine the pH of these solutions using indicators, or a pH meter, and compare them with the dilution concentrations.
- Find the pH of common household products and compare them to the pH of the known dilution solutions.

Another option would be to have students perform Quick LAB 19: Indicators from Natural Sources (Wilbraham, et al. 604).

Check the Learning Resources Links for additional investigations.

**Topic 5:  
Acids and  
Bases**

---

**SPECIFIC LEARNING OUTCOMES**

- C12-5-03:** Describe the relationship between the hydronium and hydroxide ion concentrations in water.  
Include: the ion product constant for water,  $K_w$
- C12-5-04:** Perform a laboratory activity to formulate an operational definition of *pH*.
- C12-5-05:** Describe how an acid-base indicator works in terms of colour shifts and Le Châtelier's principle.
- C12-5-06:** Solve problems involving *pH*.

*(continued)*

---

**Journal Writing**

1. Have students write an operational definition of *pH* in their journals.
2. Ask students to compare the acidity of a solution with *pH* = 1 with the acidity of a solution with *pH* = 3. They should be able to explain the exponential nature of the *pH* scale using this comparison (Dingrando, et al., *Glencoe Chemistry: Matter and Change, Teacher Wraparound Edition* 612).

**Research Projects**

Have students research and report on topics such as the following:

- Acid-containing and acid-free paper
- Acids in cooking
- Biographical sketches of Søren P. Sørensen (who developed the *pH* scale) or Arnold Orville Beckman (who invented the *pH* meter)
- Products of a specific *pH* (e.g., shampoos, antacids)

**Demonstrations**

Demonstrations showing colour changes are readily available. For example, a series of four *Chemical Demonstrations* books by Bassam Z. Shakhshiri are available for chemistry teachers who enjoy performing demonstrations for the class. One complete volume of this set is devoted to colour changes in chemistry.

A few procedures for demonstrations are provided below for reference.

- **The *pH* Rainbow Tube**

Fill a glass tube with universal indicator solution. Stopper each end. Add two drops of hydrochloric acid (HCl) to one end of the tube and two drops of sodium hydroxide (NaOH) to the other end. Use HCl and NaOH of equal concentrations. Invert the tube several times and note the colour spectrum in the tube.



**SKILLS AND ATTITUDES OUTCOMES**

**C12-0-U1:** Use appropriate strategies and skills to develop an understanding of chemical concepts.

*Examples: analogies, concept frames, concept maps, manipulatives, particulate representations, role-plays, simulations, sort-and-predict frames, word cycles . . .*

**C12-0-S7:** Interpret patterns and trends in data, and infer and explain relationships.

**C12-0-S9:** Draw a conclusion based on the analysis and interpretation of data.

*Include: cause-and-effect relationships, alternative explanations, and supporting or rejecting a hypothesis or prediction*

---

■ **Dry Ice Tube**

Place dry ice into a 1000 mL graduated cylinder of universal indicator made slightly basic. As the carbon dioxide (CO<sub>2</sub>) bubbles through the solution, it forms carbonic acid, and the pH gradually changes from basic to acidic.

■ **Milk of Magnesia**

Add 50 mL of milk of magnesia and a few drops of universal indicator to a beaker. Use a magnetic stirrer to mix the solution. Add 50 mL of 0.5 mol/L hydrochloric acid. The colour will change as the basic solution becomes acidified. The colour will change back as the buffering salts in the milk of magnesia raise the pH once again.

■ **The Rainbow Connection**

Secretly place a series of seven combinations of indicators into seven empty glasses. Add a clear acid solution to each of the glasses and have students watch the following colours appear: red, orange, yellow, green, blue, indigo, and violet.

**Simulations/Animations**

Have students view online simulations or animations of how an acid-base indicator works in terms of colour shifts.

*Sample Website:*

Chemical Education Research Group, Iowa State University. "Chemistry Experiment Simulations and Conceptual Computer Animations." *Chemical Education*. <<http://group.chem.iastate.edu/Greenbowe/sections/projectfolder/simDownload/index4.html>> (22 Nov. 2012).

In the Acid-Base Equilibria section, download and unzip the following simulation:

■ pH Measurements of Acids and Bases

In this simulation, students can determine the pH of various acidic and basic solutions by inserting probes into the solutions and reading the pH values given on the pH meter.

**Topic 5:  
Acids and  
Bases**

---

**SPECIFIC LEARNING OUTCOMES**

- C12-5-03:** Describe the relationship between the hydronium and hydroxide ion concentrations in water.  
Include: the ion product constant for water,  $K_w$
- C12-5-04:** Perform a laboratory activity to formulate an operational definition of *pH*.
- C12-5-05:** Describe how an acid-base indicator works in terms of colour shifts and Le Châtelier's principle.
- C12-5-06:** Solve problems involving *pH*.

*(continued)*

---

**SUGGESTIONS FOR ASSESSMENT**

---

**Paper-and-Pencil Tasks**

Students can solve problems, given *pH*,  $[H_3O^+]$ , or  $[OH^-]$ , to calculate the concentration of the opposing acid or base.

**Laboratory Skills**

Students should be able to set up properly the *pH* range of indicators. Assess students' lab skills and work habits using checklists available in *SYSTH* (6.10, 6.11).

**Laboratory Reports**

The lab activity could be assessed using the Laboratory Report Format (see *SYSTH* 14.12). Word processing and spreadsheet software could be used to prepare reports. Also refer to the Lab Report Assessment rubric in Appendix 11.

**Research and Reports/Presentations**

1. Have students research plants that grow best in acidic soil and plants that grow best in basic soil. They can investigate how soils can be made more acidic or more basic (Dingrando, et al., *Glencoe Chemistry: Matter and Change, Teacher Wraparound Edition* 609).
2. Have students "research the *pH* of skin and how various products—particularly basic soaps—can interact with substances that protect the skin" (Dingrando, et al., *Glencoe Chemistry: Matter and Change, Teacher Wraparound Edition* 611).

Students could present their research findings either individually or in small groups as written reports, oral presentations, or visual displays. Sample presentation rubrics are provided in Appendix 11.

**SKILLS AND ATTITUDES OUTCOMES**

**C12-0-U1:** Use appropriate strategies and skills to develop an understanding of chemical concepts.

*Examples: analogies, concept frames, concept maps, manipulatives, particulate representations, role-plays, simulations, sort-and-predict frames, word cycles . . .*

**C12-0-S7:** Interpret patterns and trends in data, and infer and explain relationships.

**C12-0-S9:** Draw a conclusion based on the analysis and interpretation of data.

Include: cause-and-effect relationships, alternative explanations, and supporting or rejecting a hypothesis or prediction

**LEARNING RESOURCES LINKS**

*A Basic Course in the Theory and Practice of Quantitative Chemical Analysis* (Fischer 265)

*Chemical Demonstrations: A Handbook for Teachers of Chemistry*, Vol. 1 to 4 (Shakhashiri)

*Glencoe Chemistry: Matter and Change, Teacher Wraparound Edition* (Dingrando, et al. 609–612)

**Investigations**

*Glencoe Chemistry: Matter and Change* (Dingrando, et al.)  
Section 19.3: What Is pH? 608

*Prentice Hall Chemistry* (Wilbraham, et al.)  
Quick LAB 19: Indicators from Natural Sources, 604

*Prentice Hall Chemistry: Laboratory Manual, Teacher's Edition* (Wilbraham, Staley, and Matta)  
Experiment 40: Estimation of pH, 247–250

*Prentice Hall Chemistry: Small-Scale Laboratory Manual, Teacher's Edition* (Waterman and Thompson)  
Experiment 30: Small-Scale Colorimetric pH Meter, 213–215

**Websites**

Chemical Education Research Group, Iowa State University. "Chemistry Experiment Simulations and Conceptual Computer Animations." *Chemical Education*. <<http://group.chem.iastate.edu/Greenbowe/sections/projectfolder/simDownload/index4.html>> (22 Nov. 2012).

Simulation: pH Measurements of Acids and Bases

Clark, Jim. "Acid-Base Indicators." *Chemguide*. 2002, mod. Dec. 2006. <[www.chemguide.co.uk/physical/acidbaseeqia/indicators.html](http://www.chemguide.co.uk/physical/acidbaseeqia/indicators.html)> (22 Nov. 2012).

**Appendices**

Appendix 5.1: Selected Neutralization Indicators

Appendix 5.2: Acid-Base Indicators and pH: Lab Activity

Appendix 5.3A: Measuring pH: Lab Activity

Appendix 5.3B: Measuring pH: Lab Activity (Teacher Notes)

**Selecting Learning Resources**

For additional information on selecting learning resources for Grade 11 and Grade 12 Chemistry, see the Manitoba Education website at <[www.edu.gov.mb.ca/k12/learnres/bibliographies.html](http://www.edu.gov.mb.ca/k12/learnres/bibliographies.html)>.

## Topic 5: Acids and Bases

### SPECIFIC LEARNING OUTCOMES

**C12-5-07:** Distinguish between strong and weak acids and bases.

Include: electrolytes and non-electrolytes

**C12-5-08:** Write the equilibrium expression ( $K_a$  or  $K_b$ ) from a balanced chemical equation.

**C12-5-09:** Use  $K_a$  or  $K_b$  to solve problems for pH, percent dissociation, and concentration.

(5 hours)

SLO: C12-5-07  
SLO: C12-5-08  
SLO: C12-5-09

### SUGGESTIONS FOR INSTRUCTION

#### Entry-Level Knowledge

In Topic 1: Reactions in Aqueous Solutions (C12-1-03), students were introduced to acid-base nomenclature and strong acids and bases.

In Topic 4: Chemical Equilibrium (C12-4-03), equilibrium constants were discussed as indicators of whether a reaction went more or less to completion. Students will now use this knowledge to explain the difference between strong and weak acids and bases.

#### TEACHER NOTES

##### Demonstration

Demonstrate the difference between electrolytes and non-electrolytes using an electrical conductivity tester with distilled water, a salt-water solution, a sugar-water solution, and ordinary tap water.

When the electrodes are placed in the distilled water, the bulb will not light. After a small number of salt crystals dissolve, the bulb will light dimly. As more and more salt crystals dissolve, the bulb will glow brighter.

Test the electrical conductivities of 0.1 mol/L aqueous solutions of hydrochloric acid and acetic acid using a conductivity apparatus. Students will recognize that both tests will result in a glowing filament, but the hydrochloric acid sample will glow brighter than the acetic acid sample – due to its virtual 100% dissociation (strong acid) and the greater number of free ions formed.

#### General Learning Outcome Connections

**GLO D3:** Understand the properties and structures of matter, as well as various common manifestations and applications of the actions and interactions of matter.

**SKILLS AND ATTITUDES OUTCOME**

**C12-0-U1:** Use appropriate strategies and skills to develop an understanding of chemical concepts.

*Examples: analogies, concept frames, concept maps, manipulatives, particulate representations, role-plays, simulations, sort-and-predict frames, word cycles . . .*

**Strengths of Acids and Bases**

In Grade 11 Chemistry, students learned to understand the difference between a dilute solution (e.g., 0.0010 mol /L) and concentrated solution (e.g., 11.2 mol/L). Now students will be shown how to differentiate between strong and weak acids and bases. Clearly, a dilute solution of a strong acid is possible (e.g., 0.0010 mol/L of sulphuric acid), as is a concentrated solution of a weak acid (e.g., 17.4 mol/L acetic acid).

Acids and bases differ greatly in their strength, as discussed below.

- **Strong Acids**

In general, a strong acid, HA, will dissociate essentially 100% and have a very large  $K_{\text{eq}}$ . This means that the reaction goes to completion towards products with very little, if any, of the reactant HA left.

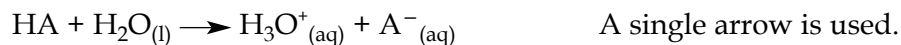

Chemists do not usually write equilibrium expressions for strong acids and bases because there is essentially no equilibrium. If they did, the equilibrium expression would look like this:

$$K_{\text{eq}} = \frac{[\text{H}_3\text{O}^+][\text{A}^-]}{[\text{HA}]} \quad \text{At equilibrium, } K_{\text{eq}} \text{ is very large: } K_{\text{eq}} > 1.$$

For a strong acid, such as hydrochloric acid (HCl), there are virtually no HCl molecules present in the aqueous solution of acid.

$$K_{\text{eq}} = \text{very large for HCl}$$

Other examples of strong acids are

- perchloric acid (HClO<sub>4</sub>)
- hydroiodic acid (HI)
- hydrobromic acid (HBr)
- sulphuric acid (H<sub>2</sub>SO<sub>4</sub>)

## Topic 5: Acids and Bases

### SPECIFIC LEARNING OUTCOMES

**C12-5-07:** Distinguish between strong and weak acids and bases.

Include: electrolytes and non-electrolytes

**C12-5-08:** Write the equilibrium expression ( $K_a$  or  $K_b$ ) from a balanced chemical equation.

**C12-5-09:** Use  $K_a$  or  $K_b$  to solve problems for pH, percent dissociation, and concentration.

(continued)

#### ■ Strong Bases

A strong base also completely dissociates into ions.

Examples of strong bases are

- sodium hydroxide (NaOH)
- potassium hydroxide (KOH)
- lithium hydroxide (LiOH)
- calcium hydroxide ( $\text{Ca}(\text{OH})_2$ )
- rubidium hydroxide (RbOH)
- barium hydroxide ( $\text{Ba}(\text{OH})_2$ )

#### Note:

In both strong acids and strong bases, the reaction is so far to the right that there is essentially no reactant left, and so there is no equilibrium.

For strong acids and bases, the reactions use only a forward arrow, denoting no reverse reaction.

0.50 mol/L of HCl will produce  
 $[\text{H}^+] = [\text{Cl}^-] = 0.50 \text{ mol/L}$

0.50 mol/L of NaOH will produce  
 $[\text{Na}^+] = [\text{OH}^-] = 0.50 \text{ mol/L}$

#### ■ Weak Acids

A weak acid dissociates only slightly into ions.

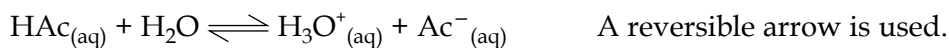

In this case, very little product is formed (i.e., the reverse reaction is preferred), and  $K_{\text{eq}}$  is very small,  $K_{\text{eq}} < 1$ .

In the example of hydrocyanic acid (HCN),

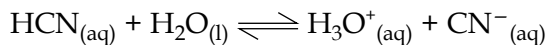

$$K_{\text{eq}} = 6.2 \times 10^{-10}$$

## SKILLS AND ATTITUDES OUTCOME

**C12-0-U1:** Use appropriate strategies and skills to develop an understanding of chemical concepts.

*Examples: analogies, concept frames, concept maps, manipulatives, particulate representations, role-plays, simulations, sort-and-predict frames, word cycles . . .*

The equilibrium expression can be simplified, since the concentration of water is very large compared to the concentration of the acid. As a result, the equilibrium expression can be written as

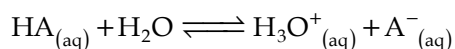

$$K_a = \frac{[\text{H}_3\text{O}^+][\text{A}^-]}{[\text{HA}]}$$

where  $K_a$  is called the acid dissociation constant.

**Note:**

The value of  $K_a$  or  $K_b$  in the case of a base provides a measure of the relative strength of an acid or a base.

Other examples of weak acids are

- citric acid ( $\text{H}_3\text{C}_6\text{H}_5\text{O}_7$ )
- acetic acid (ethanoic acid) ( $\text{CH}_3\text{COOH}$ ;  $\text{HC}_2\text{H}_3\text{O}_2$ )
- boric acid ( $\text{H}_3\text{BO}_3$ )
- phosphoric acid ( $\text{H}_3\text{PO}_4$ )

■ **Weak Bases**

A weak base dissociates only slightly into ions.

An important weak base is ammonia.

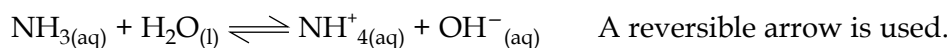

The equilibrium expression can be written as

$$K_{\text{eq}} = \frac{[\text{NH}_4^+][\text{OH}^-]}{[\text{NH}_3]}$$

The equilibrium expression can be simplified, since the concentration of water is very large compared to the concentration of the base. As a result, the equilibrium expression can be written as

$$K_b = \frac{[\text{NH}_4^+][\text{OH}^-]}{[\text{NH}_3]} = 1.8 \times 10^{-5}$$

Other examples of weak bases are

- aniline base ( $\text{C}_6\text{H}_5\text{NH}_2$ )
- methylamine base ( $\text{CH}_3\text{NH}_2$ )
- pyridine base ( $\text{C}_5\text{H}_5\text{N}$ )

**Topic 5:  
Acids and  
Bases**

---

**SPECIFIC LEARNING OUTCOMES****C12-5-07:** Distinguish between strong and weak acids and bases.

Include: electrolytes and non-electrolytes

**C12-5-08:** Write the equilibrium expression ( $K_a$  or  $K_b$ ) from a balanced chemical equation.**C12-5-09:** Use  $K_a$  or  $K_b$  to solve problems for pH, percent dissociation, and concentration.*(continued)*

---

**Review**

Appendix 5.4: Relative Strengths of Acids provides a  $K_a$  chart for acids. The larger the  $K_a$  is, the stronger the acid is and the greater the tendency to release  $H^+$  ( $H_3O^+$ ) ions into solution. If we follow this argument, the species on the right side of the arrow are bases. They have a tendency to pick up  $H^+$  ( $H_3O^+$ ). If the strongest acids are on the top left, then the strongest bases must be toward the bottom of the right. The amide ion ( $NH_2^-$ ) is, therefore, the strongest base species, closely followed by the oxide ion ( $O^{2-}$ ).

To summarize:

*Acids*Stronger acid  $\Rightarrow$  higher % dissociation  $\Rightarrow$  higher  $[H_3O^+]$   $\Rightarrow$  larger  $K_a$ 

Conversely,

Smaller  $K_a \Rightarrow$  lower  $[H_3O^+]$   $\Rightarrow$  lower % dissociation  $\Rightarrow$  weaker acid*Bases*Stronger base  $\Rightarrow$  higher % dissociation  $\Rightarrow$  higher  $[OH^-]$   $\Rightarrow$  larger  $K_b$ 

Conversely,

Smaller  $K_b \Rightarrow$  lower  $[OH^-]$   $\Rightarrow$  lower % dissociation  $\Rightarrow$  weaker base**Demonstration**

Add equal amounts and concentrations of hydrochloric acid (HCl) and acetic acid ( $CH_3COOH$ ) to magnesium metal. While HCl will react vigorously,  $CH_3COOH$  will not. This is because of the number of hydronium ions produced by each acid. (This demonstration can also be used to reinforce the concepts of reaction rates and concentrations of reactants.)



**SKILLS AND ATTITUDES OUTCOME**

**C12-0-U1:** Use appropriate strategies and skills to develop an understanding of chemical concepts.

*Examples: analogies, concept frames, concept maps, manipulatives, particulate representations, role-plays, simulations, sort-and-predict frames, word cycles . . .*

**Animations**

Have students view online animations of strong and weak acids and bases.

*Sample Website:*

Chang, Raymond. "Essential Study Partner." *Chemistry*. 7th ed. McGraw Hill Online Learning Centre. <[http://highered.mcgraw-hill.com/sites/0073656011/student\\_view0/chapter15/essential\\_study\\_partner.html#](http://highered.mcgraw-hill.com/sites/0073656011/student_view0/chapter15/essential_study_partner.html#)> (21 Mar. 2012).

This website provides a variety of animations related to acids and bases:

- *Acid Strength* shows the difference in ionization between a strong acid solution and a weak acid solution.
- *Base Strength* shows the difference in ionization between a strong base solution and a weak base solution.

**SUGGESTIONS FOR ASSESSMENT****Types of Problems**

When having students solve problems using  $K_a$  or  $K_b$ , ask the questions in a variety of ways, including the following variables: initial concentration,  $[H_3O^+]$ ,  $[OH^-]$ , percent dissociation, pH, pOH,  $K_a$ , and  $K_b$ .

Avoid presenting too many different types of questions before students have understood and mastered the basic questions (e.g., assign questions with reverse calculations only after students understand the forward calculations). Add pH and pOH later.

There are basically two types of questions for a weak acid and/or a weak base, as described below.

1. Given the initial concentration of the acid and/or base and the percent dissociation, pH, pOH, and  $[H_3O^+]$  or  $[OH^-]$ , find  $K_a$  or  $K_b$ .

*Example:*

Using a 0.75 mol/L solution of a weak base ammonia ( $NH_3$ ) and  $[OH^-] = 1.0 \times 10^{-4}$  mol/L, find  $K_b$ .

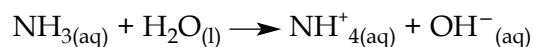

Write the equilibrium expression.

$$K_b = \frac{[NH_4^+][OH^-]}{[NH_3]}$$

**Topic 5:**  
**Acids and**  
**Bases**

## SPECIFIC LEARNING OUTCOMES

**C12-5-07:** Distinguish between strong and weak acids and bases.

Include: electrolytes and non-electrolytes

**C12-5-08:** Write the equilibrium expression ( $K_a$  or  $K_b$ ) from a balanced chemical equation.

**C12-5-09:** Use  $K_a$  or  $K_b$  to solve problems for pH, percent dissociation, and concentration.

(continued)

Substitute the given values.

$$K_b = \frac{[1.0 \times 10^{-4}][1.0 \times 10^{-4}]}{[0.75]}$$

$$[\text{NH}_4^+] = [\text{OH}^-] = 1.0 \times 10^{-4} \text{ mol/L, since the stoichiometry is 1:1}$$

$$K_b = 1.3 \times 10^{-8}$$

2. Given the initial concentration of the acid and/or base and  $K_a$  or  $K_b$ , find  $[\text{H}_3\text{O}^+]$ ,  $[\text{OH}^-]$ , percent dissociation, pH, and pOH.

*Example:*

Using 0.75 mol/L solution of a weak acid hydrogen peroxide ( $\text{H}_2\text{O}_2$ ), find  $[\text{H}_3\text{O}^+]$  and the percent dissociation.

The  $K_a$  is taken from a  $K_a$  table (see Appendix 5.4: Relative Strengths of Acids).

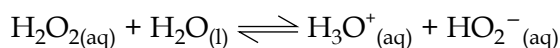

The equilibrium expression is

$$K_a = \frac{[\text{H}_3\text{O}^+][\text{HO}_2^-]}{[\text{H}_2\text{O}_2]} = 2.4 \times 10^{-12}$$

Let  $x$  = amount that dissociates.

Therefore, at equilibrium,

$$[\text{H}_2\text{O}_2] = 0.75 - x$$

$$[\text{H}_3\text{O}^+] = 0 + x$$

$$[\text{HO}_2^-] = 0 + x$$

**Note:**

In Topic 4: Chemical Equilibrium, students were introduced to the ICE table and the BIR/PEC methods of accounting.

## SKILLS AND ATTITUDES OUTCOME

**C12-0-U1:** Use appropriate strategies and skills to develop an understanding of chemical concepts.

*Examples: analogies, concept frames, concept maps, manipulatives, particulate representations, role-plays, simulations, sort-and-predict frames, word cycles . . .*

Substitute the equilibrium concentration values into the  $K_a$  expression and solve for  $x$ .

$$2.4 \times 10^{-12} = \frac{(0+x)(0+x)}{(0.75 \text{ mol/L} - x)}$$

When solving this problem according to mathematical procedures, the quadratic formula would be used.

**Note:**

Avoid using the quadratic formula to solve dissociation problems, unless conditions exist for student success with this level of treatment.

Chemists use the following assumption to simplify the calculation and avoid using the quadratic formula.

- If  $x$  is much less than the initial concentration of the weak acid or the weak base,  $x$  can be neglected when compared to 0.75, and so on. Hence,  $(0.75 \text{ mol/L} - x)$  becomes 0.75 to two significant figures.

This is only possible when  $x$  is negligible compared to the initial concentration.

- If  $K_a$  or  $K_b$  is quite large, and/or the initial concentration is given as more significant figures, the assumption may not work, and the quadratic formula would have to be used.

With this assumption, the equilibrium expression becomes

$$2.4 \times 10^{-12} = \frac{(0+x)(0+x)}{(0.75 \text{ mol/L})}$$

simplified to

$$2.4 \times 10^{-12} = \frac{x^2}{(0.75 \text{ mol/L})}$$

and

$$x = 1.3 \times 10^{-6}$$

Teachers may want to show students how this is possible, by checking the final answer to two significant figures ( $0.75 \text{ mol/L} - 0.000013 \text{ mol/L} = 0.75 \text{ mol/L}$  to two significant figures).

## Topic 5: Acids and Bases

### SPECIFIC LEARNING OUTCOMES

**C12-5-07:** Distinguish between strong and weak acids and bases.

Include: electrolytes and non-electrolytes

**C12-5-08:** Write the equilibrium expression ( $K_a$  or  $K_b$ ) from a balanced chemical equation.

**C12-5-09:** Use  $K_a$  or  $K_b$  to solve problems for pH, percent dissociation, and concentration.

(continued)

Hence,

$$x = [\text{H}_3\text{O}^+] = [\text{HO}_2^-] = 1.3 \times 10^{-6} \text{ mol/L}$$

$$\begin{aligned} \text{percent dissociation} &= \frac{[\text{H}_3\text{O}^+] \text{ or } [\text{HO}_2^-]}{\text{initial concentration}} \times 100 \\ &= \frac{1.3 \times 10^{-6}}{0.75} \times 100 \\ &= 1.7 \times 10^{-4}\% \text{ or } 0.00017\% \end{aligned}$$

Once students have mastered these types of questions, then pH and pOH could be used instead of  $[\text{H}_3\text{O}^+]$  and  $[\text{OH}^-]$ .

### $K_a$ and $K_b$ Constants and Le Châtelier's Principle

There is another type of question that can be asked that involves  $K_a$  and  $K_b$  constants and Le Châtelier's principle. Some examples are provided below.

For each of the sample problems, have students do the following:

- Complete the acid-base reaction with the help of tables.
- Specify the two acids and bases involved.
- Specify the stronger and weaker of the acids.
- Indicate whether reactants or products are favoured at equilibrium.

Sample Problems:

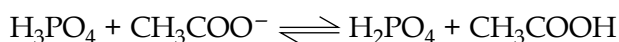

$K_a = 7.5 \times 10^{-3}$	$K_a = 1.8 \times 10^{-5}$
----------------------------	----------------------------

Stronger acid	Weaker acid
---------------	-------------

Products favoured →

**SKILLS AND ATTITUDES OUTCOME**
**C12-0-U1:** Use appropriate strategies and skills to develop an understanding of chemical concepts.

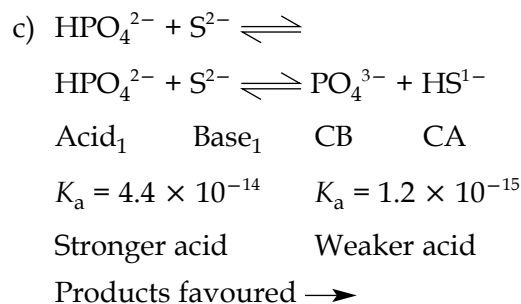
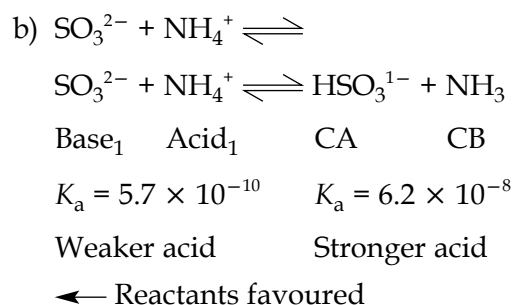
*Examples: analogies, concept frames, concept maps, manipulatives, particulate representations, role-plays, simulations, sort-and-predict frames, word cycles . . .*

*Challenge Questions:*

One mL of 0.10 mol/L HCl is added to each of five test tubes containing 10 mL of 1.0 mol/L solutions of the five ions listed below.

In each case,

- write the acid-base reaction according to Brønsted
- identify the acids and bases on both sides of the reaction
- specify in which case the hydronium ion concentration is lowered the most by the reaction with HCl

- a)  $\text{CO}_3^{2-}$
- b)  $\text{HCO}_3^-$
- c)  $\text{HPO}_4^{2-}$
- d)  $\text{CH}_3\text{COO}^-$
- e)  $\text{HSO}_3^-$

**Topic 5:**  
**Acids and**  
**Bases**

**SPECIFIC LEARNING OUTCOMES**

**C12-5-07:** Distinguish between strong and weak acids and bases.

Include: electrolytes and non-electrolytes

**C12-5-08:** Write the equilibrium expression ( $K_a$  or  $K_b$ ) from a balanced chemical equation.

**C12-5-09:** Use  $K_a$  or  $K_b$  to solve problems for pH, percent dissociation, and concentration.

(continued)

*Solutions:*

- |    | B                            | A     | CA                   | CB  |
|----|------------------------------|-------|----------------------|---|
| a) | $\text{CO}_3^{2-}$           | + HCl | $\rightleftharpoons$ | $\text{HCO}_3^{1-}$ + $\text{Cl}^{1-}$          |
|    | $K_a$ very large             |       |                      | $K_a = 4.7 \times 10^{-11}$                     |
| b) | $\text{HCO}_3^{1-}$          | + HCl | $\rightleftharpoons$ | $\text{H}_2\text{CO}_3$ + $\text{Cl}^{1-}$      |
|    | $K_a$ very large             |       |                      | $K_a = 4.4 \times 10^{-7}$                      |
| c) | $\text{HPO}_4^{2-}$          | + HCl | $\rightleftharpoons$ | $\text{H}_2\text{PO}_4^{1-}$ + $\text{Cl}^{1-}$ |
|    | $K_a$ very large             |       |                      | $K_a = 6.3 \times 10^{-8}$                      |
| d) | $\text{CH}_3\text{COO}^{1-}$ | + HCl | $\rightleftharpoons$ | $\text{CH}_3\text{COOH}$ + $\text{Cl}^{1-}$     |
|    | $K_a$ very large             |       |                      | $K_a = 1.8 \times 10^{-5}$                      |
| e) | $\text{HSO}_3^{1-}$          | + HCl | $\rightleftharpoons$ | $\text{H}_2\text{SO}_3$ + $\text{Cl}^{1-}$      |
|    | $K_a$ very large             |       |                      | $K_a = 6.2 \times 10^{-8}$                      |

As the  $K_a$  for HCl is constant in each reaction, we are comparing the  $K_a$  values for the conjugate acids.

Since the  $K_a$  for  $\text{CH}_3\text{COOH}$  is the largest compared to the others, that reaction will go the least to the right. The  $K_a$  for  $\text{HCO}_3^{1-}$  is the smallest, having the least effect on the  $K_a$  for HCl, and, therefore, that reaction will go the furthest to the right, thus causing the hydronium concentration to be lowered the most.

**Paper-and-Pencil Tasks**

1. Students should be able to write the equilibrium expression ( $K_a$  or  $K_b$ ) from a balanced chemical equation.
2. Students should be able to solve problems for pH, percent dissociation, and concentration, given the  $K_a$  or  $K_b$ .

**SKILLS AND ATTITUDES OUTCOME**

**C12-0-U1:** Use appropriate strategies and skills to develop an understanding of chemical concepts.

*Examples: analogies, concept frames, concept maps, manipulatives, particulate representations, role-plays, simulations, sort-and-predict frames, word cycles . . .*

---

**Compare and Contrast**

Ask students to complete a Compare and Contrast frame for weak and strong acids and for weak and strong bases (see *SYSTH* 10.24).

**LEARNING RESOURCES LINKS**

---



*Glencoe Chemistry: Matter and Change* (Dingrando, et al.)  
Chapter 19: Acids and Bases

*Prentice Hall Chemistry* (Wilbraham, et al.)  
Chapter 19: Acids and Bases

**Appendix**

Appendix 5.4: Relative Strengths of Acids

**Selecting Learning Resources**

For additional information on selecting learning resources for Grade 11 and Grade 12 Chemistry, see the Manitoba Education website at <[www.edu.gov.mb.ca/k12/learnres/bibliographies.html](http://www.edu.gov.mb.ca/k12/learnres/bibliographies.html)>.

**Topic 5:  
Acids and  
Bases****SPECIFIC LEARNING OUTCOME**

**C12-5-10:** Perform a laboratory activity to determine the concentration of an unknown acid or base, using a standardized acid or base.

(3 hours)

SLO: C12-5-10

**SUGGESTIONS FOR INSTRUCTION****Entry-Level Knowledge**

In Grade 10 Science (S2-2-02), students explained how acids and bases interact to form a salt and water in the process of neutralization.

In Topic 1: Reactions in Aqueous Solutions (C12-1-04), students performed a lab activity to demonstrate the stoichiometry of a neutralization reaction between a strong base and a strong acid.

**Assessing Prior Knowledge**

The lab experiment that students will perform for this learning outcome requires a complete understanding of the process and theory of neutralization from Topic 1: Reactions in Aqueous Solutions. To reduce the possibility of poor quantitative results, do a thorough review of neutralization before assigning the lab experiment.

Check for understanding of students' prior knowledge, and review concepts as necessary. Prior knowledge can be reviewed and/or assessed by using any of the KWL strategies (e.g., Concept Map, Knowledge Chart, Think-Pair-Share—see *SYSTH*, Chapter 9).

**General Learning Outcome Connections**

- GLO B3:** Identify the factors that affect health, and explain the relationships among personal habits, lifestyle choices, and human health, both individual and social.
- GLO B5:** Identify and demonstrate actions that promote a sustainable environment, society, and economy, both locally and globally.
- GLO C1:** Recognize safety symbols and practices related to scientific and technological activities and to their daily lives, and apply this knowledge in appropriate situations.
- GLO C2:** Demonstrate appropriate scientific inquiry skills when seeking answers to questions.
- GLO C5:** Demonstrate curiosity, skepticism, creativity, open-mindedness, accuracy, precision, honesty, and persistence, and appreciate their importance as scientific and technological habits of mind.



**SKILLS AND ATTITUDES OUTCOMES**

**C12-0-S1:** Demonstrate work habits that ensure personal safety and the safety of others, as well as consideration for the environment.

Include: knowledge and use of relevant safety precautions, Workplace Hazardous Materials Information System (WHMIS), and emergency equipment

**C12-0-S5:** Collect, record, organize, and display data using an appropriate format.

Examples: labelled diagrams, graphs, multimedia applications, software integration, probeware . . .

**C12-0-S6:** Estimate and measure accurately using Système International (SI) and other standard units.

Include: SI conversions and significant figures

---

**TEACHER NOTES****Acid-Base Titration Lab Activities**

Burettes found in schools will differ greatly in quality. Many schools still have burettes with a length of rubber hose, a glass tip, part of an eyedropper, and a pinch clamp to regulate the stream of liquid. The number and size of drops are not easy to control with these burettes, and so their accuracy and reliability could be less than those of Teflon spigots and a 120-second tip.

In Topic 1: Reactions in Aqueous Solutions, teachers may have given students microscale well plates with which to conduct their neutralization investigation. If this was the case, then students may not have seen a burette before and must first be introduced to the care and correct use of this delicate piece of equipment.

The lab activity provided in Appendix 5.5: Quantitative Analysis: Acid-Base Titration: Lab Activity assumes that enough burettes are available for each student in the class to have one for the acid and another for the base. If this is not possible, two students could share a common burette for the standard solution, but each should have his or her own unknown solution in a separate burette.

If students are asked to do Part B of the lab activity, which involves the titration of a solid acid, they will need an accurate quantitative method of dissolving the sample of acid provided. This is best done with a volumetric flask, as is indicated in Appendix 5.5. Note that having an electronic balance that reads to 0.001 g would help increase the accuracy of the results.

If students do both parts of the lab activity, review the procedure after students have first read the lab instructions as an assignment (prior knowledge). Then initiate a discussion of lab skills and experimental errors. At this time, explain what accuracy and reliability are with respect to this experiment.

If teachers wish to expose students to various types of titration curves (e.g., strong acid-weak base, weak acid-strong base, weak acid-weak base), refer to Appendix 5.9: Samples of Various Titration Curves (Teacher Notes).

**Topic 5:  
Acids and  
Bases****SPECIFIC LEARNING OUTCOME**

**C12-5-10:** Perform a laboratory activity to determine the concentration of an unknown acid or base, using a standardized acid or base.

(continued)

---

**Laboratory Activities**

Have students complete the lab activity outlined in Appendix 5.5: Quantitative Analysis: Acid-Base Titration: Lab Activity.

Depending on the time available, teachers may wish to use alternative or additional lab activities that involve the titration process, such as the following:

- Appendix 5.6: Analysis of Household Vinegar: Lab Activity
- Appendix 5.7: Analysis of Aspirin: Lab Activity
- Appendix 5.8: Potentiometric Analysis of Acid in Soft Drinks: Cola versus Non-cola: Lab Activity
- Titration of Sodium Hypochlorite in Bleach with Sodium Thiosulfate (Waterman and Thompson 113)
- *Chemistry with Vernier* (Holmquist, Randall, and Volz) suggests two additional experiments:
  - Experiment 31: Time-Released Vitamin C Tablets
  - Experiment 35: Determining the Phosphoric Acid Content in Soft Drinks

See Learning Resources Links for references.

**SUGGESTIONS FOR ASSESSMENT**

---

**Paper-and-Pencil Tasks**

Ask students to do the following:

1. Compare and contrast or define the following terms: *titrate*, *titrant*, *end point*, *equivalence point*, *indicator*, *aliquot*, *standard solution*, and *dilute*. Students could use a Word Cycle, Compare and Contrast frames, or other vocabulary strategies to demonstrate their understanding of the terms (see SYSTH 10.21, 10.24).
2. Explain why adding more solvent water to the sample being titrated has no effect on the end point.
3. Discuss the lab results, including a discussion of experimental errors.

**SKILLS AND ATTITUDES OUTCOMES**

**C12-0-S1:** Demonstrate work habits that ensure personal safety and the safety of others, as well as consideration for the environment.

Include: knowledge and use of relevant safety precautions, Workplace Hazardous Materials Information System (WHMIS), and emergency equipment

**C12-0-S5:** Collect, record, organize, and display data using an appropriate format.

Examples: labelled diagrams, graphs, multimedia applications, software integration, probeware . . .

**C12-0-S6:** Estimate and measure accurately using Système International (SI) and other standard units.

Include: SI conversions and significant figures

---

**Laboratory Skills**

Students should be able to titrate a strong acid with a strong base.

Lab skills might include

- massing of a solid acid
- quantitative transfer of solids
- use of a volumetric flask
- reading a burette to  $\pm 0.01$
- performing the process of titration

To assess students' lab skills and work habits, refer to checklists in *SYSTH* (6.10, 6.11).

**Research Skills**

Teachers may wish to have students search (e.g., on the Internet) for examples of various research and industrial applications of the titration process, such as the following:

- testing of acid rain
- pH soil testing
- efficacy of antacid tablets or acetylsalicylic acid (Aspirin)
- concentration of oxygen in surface waters (sodium thiocyanate titrant and starch solution indicator)
- maintenance of a required pH during the growth of bacteria
- identification of food additives
- determination of the surface area of marine algae used by marine biologists to determine the condition of marine coral reefs
- testing the phosphoric acid content in soft drinks

**Topic 5:  
Acids and  
Bases**

**SPECIFIC LEARNING OUTCOME**

**C12-5-10:** Perform a laboratory activity to determine the concentration of an unknown acid or base, using a standardized acid or base.

(continued)

*Sample Websites:*

Sea and Sky. "Reefkeeper's FAQ." *Aquarium Resources*.

<[www.seasky.org/aquarium/aquarium\\_faq\\_page01.html](http://www.seasky.org/aquarium/aquarium_faq_page01.html)> (21 Mar. 2012)

This website provides information on how marine scientists monitor the environment of coral reefs.

SparkNotes Editors. "SparkNote on Titrations." *SparkNotes.com*. SparkNotes LLC.

<[www.sparknotes.com/chemistry/acidsbases/titrations/section1.html](http://www.sparknotes.com/chemistry/acidsbases/titrations/section1.html)> (21 Mar. 2012).

This website provides definitions and explanations of titration and the related terms.

**LEARNING RESOURCES LINKS**

---



*Chemistry* (Chang 656)

*Chemistry: The Molecular Nature of Matter and Change* (Silberberg 796)

*Glencoe Chemistry: Matter and Change* (Dingrando, et al.)  
Salt Hydrolysis, 621

*Prentice Hall Chemistry* (Wilbraham, et al.)  
Salt in Solution, 618

**Investigations**

*Chemistry with Vernier* (Holmquist, Randall, and Volz)  
Experiment 31: Time-Released Vitamin C Tablets  
Experiment 35: Determining the Phosphoric Acid Content in Soft Drinks

*Glencoe Chemistry: Matter and Change* (Dingrando, et al.)  
ChemLab 19: Standardizing a Base Solution by Titration, 626  
Antacids, 628

*Prentice Hall Chemistry: Small-Scale Chemistry Laboratory Manual* (Waterman and Thompson)  
Part 2: Titration of Sodium Hypochlorite in Bleach with Sodium Thiosulfate, 113

**SKILLS AND ATTITUDES OUTCOMES**

**C12-0-S1:** Demonstrate work habits that ensure personal safety and the safety of others, as well as consideration for the environment.

Include: knowledge and use of relevant safety precautions, Workplace Hazardous Materials Information System (WHMIS), and emergency equipment

**C12-0-S5:** Collect, record, organize, and display data using an appropriate format.

Examples: labelled diagrams, graphs, multimedia applications, software integration, probeware . . .

**C12-0-S6:** Estimate and measure accurately using Système International (SI) and other standard units.

Include: SI conversions and significant figures

---

**Websites**

Sea and Sky. "Reefkeeper's FAQ." *Aquarium Resources*.

<[www.seasky.org/aquarium/aquarium\\_faq\\_page01.html](http://www.seasky.org/aquarium/aquarium_faq_page01.html)> (21 Mar. 2012).

SparkNotes Editors. "SparkNote on Titrations." *SparkNotes.com*. SparkNotes

LLC. <[www.sparknotes.com/chemistry/acidsbases/titrations/section1.html](http://www.sparknotes.com/chemistry/acidsbases/titrations/section1.html)> (21 Mar. 2012).

**Appendices**

Appendix 5.5: Quantitative Analysis: Acid-Base Titration: Lab Activity

Appendix 5.6: Analysis of Household Vinegar: Lab Activity

Appendix 5.7: Analysis of Aspirin: Lab Activity

Appendix 5.8: Potentiometric Analysis of Acid in Soft Drinks: Cola versus Non-cola: Lab Activity

Appendix 5.9: Samples of Various Titration Curves (Teacher Notes)

**Selecting Learning Resources**

For additional information on selecting learning resources for Grade 11 and Grade 12 Chemistry, see the Manitoba Education website at <[www.edu.gov.mb.ca/k12/learnres/bibliographies.html](http://www.edu.gov.mb.ca/k12/learnres/bibliographies.html)>.

**Topic 5:**  
**Acids and**  
**Bases**

## SPECIFIC LEARNING OUTCOME

**C12-5-11:** Predict whether an aqueous solution of a given ionic compound will be acidic, basic, or neutral, given the formula.

(1 hour)

SLO: C12-5-11

## SUGGESTIONS FOR INSTRUCTION

## Entry-Level Knowledge

In previous grades, students have been introduced to the physical properties of salts as being soluble or insoluble. So far in their knowledge of chemistry, they have not encountered the chemical properties of salts.

## TEACHER NOTES

In addressing learning outcome C12-5-11, students will learn to appreciate that salts can be something other than neutral.

Many students have the misconception that salt solutions are always neutral. Students should now understand that when an acid combines with a base, a salt and water are produced. However, the resulting aqueous salt solution can be neutral, acidic, or basic, depending on the strength of the acid and base that are reacted.

## Hydrolysis of Salts

The following table (intended for teachers) provides a summary of the species involved with hydrolysis of salts (see Chang 678).

Hydrolysis of Salts			
Type of Salt	Examples	Ions That Undergo Hydrolysis	pH
Cation from strong base Anion from strong acid	NaCl, KI, KNO <sub>3</sub> , RbBr, BaCl <sub>2</sub>	None	≈ 7
Cation from strong base Anion from weak acid	NaC <sub>2</sub> H <sub>3</sub> O <sub>2</sub> , KNO <sub>2</sub>	Anion	> 7
Cation from weak base Anion from strong acid	NH <sub>4</sub> Cl, NH <sub>4</sub> NO <sub>3</sub>	Cation	< 7
Cation from weak base Anion from weak acid	NH <sub>4</sub> NO <sub>2</sub> , NH <sub>4</sub> C <sub>2</sub> H <sub>3</sub> O <sub>2</sub> , NH <sub>4</sub> CN	Anion and cation	< 7 if $K_b < K_a$ ≈ 7 if $K_b \approx K_a$ > 7 if $K_b > K_a$

## General Learning Outcome Connections

**GLO D3:** Understand the properties and structures of matter, as well as various common manifestations and applications of the actions and interactions of matter.

## SKILLS AND ATTITUDES OUTCOME

**C12-0-U1:** Use appropriate strategies and skills to develop an understanding of chemical concepts.

*Examples: analogies, concept frames, concept maps, manipulatives, particulate representations, role-plays, simulations, sort-and-predict frames, word cycles . . .*

This information can be simplified further:

- A strong acid and a strong base produce a neutral solution.
- A strong base plus a weak acid produce a slightly basic salt.
- A strong acid plus a weak base produce a slightly acidic salt.

A salt can react with the water (called *salt hydrolysis*) and the anions of the dissociated salt may accept hydrogen ions from the water, producing a basic solution, or the cations of the dissociated salt may donate hydrogen ions from the water, producing an acidic solution.

The following detailed examples will show the process that occurs to the various species during hydrolysis.

- **Cation from a strong base plus the anion from a strong acid** → pH ≈ 7  
No example is necessary, as there is no hydrolysis.
- **Cation from a strong base plus the anion from a weak acid** → pH > 7

*Example 1:*



Sodium acetate solid dissolves in water to produce sodium cations and acetate anions.

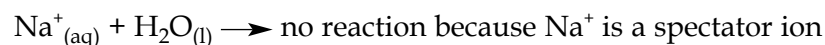
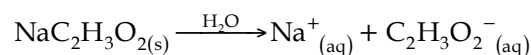

Because the  $K_a$  for  $\text{HC}_2\text{H}_3\text{O}_2$  is very small ( $1.8 \times 10^{-5}$ ), the reaction below tends to go forward, as written, to remove hydrogen ions from solution, leaving an excess of hydroxide ions.

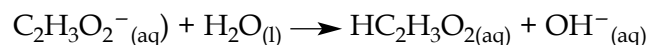

**Topic 5:**  
**Acids and**  
**Bases**

## SPECIFIC LEARNING OUTCOME

**C12-5-11:** Predict whether an aqueous solution of a given ionic compound will be acidic, basic, or neutral, given the formula.

(continued)

*Example 2:*



Since  $\text{K}_2\text{CO}_3$  comes from a strong base (KOH) and a weak acid ( $\text{H}_2\text{CO}_3$ ), a basic solution results. Potassium carbonate dissolves in water to produce potassium cations and carbonate anions.

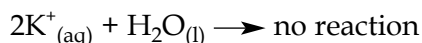
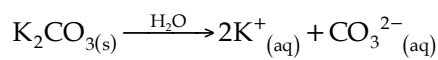

Similarly, because the  $K_a$  for carbonic acid is very small ( $4.4 \times 10^{-7}$ ), the reaction below tends to go forward, as written, to remove hydrogen ions from solution, leaving an excess of hydroxide ions.

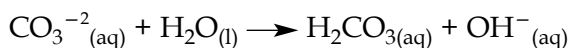

- **Cation from a weak base plus the anion from a strong acid  $\longrightarrow$  pH < 7**

*Example 3:*

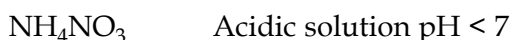

Ammonium nitrate dissolves in water to produce ammonium cations and nitrate anions.  $\text{NH}_4\text{NO}_3$  comes from a weak base ( $\text{NH}_3$ ) and a strong acid ( $\text{HNO}_3$ ), resulting in an acidic solution.

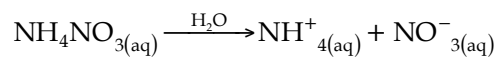

Since ammonium hydroxide is a weak base, the second reaction tends to go forward, as written, to remove hydroxide ions from solution, leaving an excess of hydrogen ions (hydronium ions).

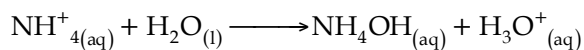
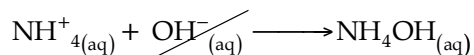
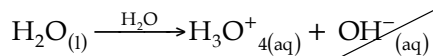

Since  $\text{H}_3\text{O}^+$  is produced, the salt is acidic. (The negative ion of any strong acid will not react with water.)



**SKILLS AND ATTITUDES OUTCOME**

**C12-0-U1:** Use appropriate strategies and skills to develop an understanding of chemical concepts.

*Examples: analogies, concept frames, concept maps, manipulatives, particulate representations, role-plays, simulations, sort-and-predict frames, word cycles . . .*

---

**Laboratory Activity**

Students could complete a simple lab activity on the hydrolysis of a number of salts to complement class discussion (see Wilbraham, Staley, and Matta, *Prentice Hall Chemistry: Laboratory Manual* 267.)

**SUGGESTIONS FOR ASSESSMENT**

---

**Paper-and-Pencil Task**

Students should be able to determine whether a salt solution is neutral, acidic, or basic, given the salt of a weak acid or the salt of a weak base.

**Compare and Contrast**

Using a Compare and Contrast frame, students should be able to explain why sodium hydrogen carbonate is an effective antacid but sodium hydroxide is not (see Dingrando, et al. 628). For a Compare and Contrast frame, see SYSTH 10.24.

**LEARNING RESOURCES LINKS**

---



*Chemistry*, 9th ed. (Chang 678)

*Chemistry: The Molecular Nature of Matter and Change* (Silberberg 796)

*Glencoe Chemistry: Matter and Change* (Dingrando, et al. 621, 628)

*Prentice Hall Chemistry* (Wilbraham, et al. 618)

**Investigation**

*Prentice Hall Chemistry: Laboratory Manual* (Wilbraham, Staley, and Matta)  
Experiment 44: Salt Hydrolysis, 267

**Selecting Learning Resources**

For additional information on selecting learning resources for Grade 11 and Grade 12 Chemistry, see the Manitoba Education website at <[www.edu.gov.mb.ca/k12/learnres/bibliographies.html](http://www.edu.gov.mb.ca/k12/learnres/bibliographies.html)>.



# TOPIC 5: ACIDS AND BASES

## APPENDICES

---

Appendix 5.1: Selected Neutralization Indicators	3
Appendix 5.2: Acid-Base Indicators and pH: Lab Activity	4
Appendix 5.3A: Measuring pH: Lab Activity	6
Appendix 5.3B: Measuring pH: Lab Activity (Teacher Notes)	8
Appendix 5.4: Relative Strengths of Acids	9
Appendix 5.5: Quantitative Analysis: Acid-Base Titration: Lab Activity	10
Appendix 5.6: Analysis of Household Vinegar: Lab Activity	14
Appendix 5.7: Analysis of Aspirin: Lab Activity	16
Appendix 5.8: Potentiometric Analysis of Acid in Soft Drinks: Cola versus Non-cola: Lab Activity	18
Appendix 5.9: Samples of Various Titration Curves (Teacher Notes)	23



## Appendix 5.1: Selected Neutralization Indicators

Indicator	Colour Change (lower pH listed first)	Approximate pH (range of colour change)
Methyl violet	Yellow to blue	0.0 to 1.6
Crystal violet	Yellow to violet	0.1 to 1.6
Paramethyl red	Red to yellow	1.0 to 3.0
Methyl yellow	Red to yellow	2.9 to 4.0
Bromophenol blue	Yellow to blue	3.0 to 4.6
Congo red	Blue to red	3.0 to 5.0
Methyl orange	Red to yellow	3.1 to 4.4
Ethyl orange	Red to yellow	3.4 to 4.5
Alizarin red S	Yellow to purple	3.7 to 5.0
Methyl red	Red to yellow	4.2 to 6.2
Methyl purple	Purple to green	4.8 to 5.4
Propyl red	Red to yellow	4.6 to 6.6
Paranitrophenol	Colourless to yellow	5.9 to 7.0
Bromcresol purple	Yellow to purple	5.2 to 6.8
Litmus	Red to blue	5.5 to 8.0
Bromothymol blue	Yellow to blue	6.0 to 7.6
Brilliant yellow	Yellow to orange	6.6 to 8.0
Neutral red	Red to amber	6.7 to 8.0
Phenol red	Yellow to red	6.7 to 8.4
Phenolphthalein	Colourless to pink	8.3 to 10.0
Thymolphthalein	Colourless to blue	9.4 to 10.6
Alizarin yellow	Yellow to red	10.0 to 12.0
Alizarin blue-5	Amber and green to blue-green	11.0 to 12.0

## Appendix 5.2: Acid-Base Indicators and pH: Lab Activity

---

### Introduction

The acidity (concentration of  $H^+$ ) or alkalinity (concentration of  $OH^-$ ) of an aqueous solution is an important factor in describing the solution's properties. The measurement of the  $H^+$  or  $OH^-$  in a solution can be accomplished in several ways.

- **Use of a pH meter:** The pH meter is an electronic device that compares voltage in a solution to that of a standard. The acidity or alkalinity is read directly from a digital or analog meter. The device is accurate and fast, but relatively expensive.
- **Use of indicator paper:** Indicator paper is ordinary filter paper that has been soaked in a solution of dye(s) called indicator(s). The indicator changes colour when the concentration of  $H^+$  reaches a certain level. While test paper is relatively inexpensive, it is difficult to follow any continuous change in the pH of the solution since the paper must be dipped in and out repeatedly.
- **Use of an indicator solution:** An indicator solution changes colour at a specific pH. Mixtures of indicators can be used to provide a continuously changing picture corresponding to changes in pH. In this lab activity, three individual indicators (methyl orange, phenolphthalein, and bromothymol blue) and a standard mixture of indicators (universal) will be used. The standard universal indicator is a mixture of organic dyes that change colour and allow for a fairly accurate approximation of the whole number pH value of a test solution.

### Purpose

To develop an operational definition of pH.

### Materials and Apparatus

well plate  
white paper  
eyedroppers  
distilled water  
0.1 mol/L hydrochloric acid (HCl)  
0.1 mol/L sodium hydroxide (NaOH)  
universal indicator  
methyl orange indicator  
phenolphthalein indicator  
bromothymol blue indicator

---

**Appendix 5.2: Acid-Base Indicators and pH: Lab Activity (continued)**

---

**Procedure**

1. Place the well plate on white paper with the lettered columns on the left. Place 9 drops of distilled water into wells 2 through 11 of rows A, B, C, and D.
2. Add 10 drops of 0.1 mol/L HCl to wells A1, B1, C1, and D1.
3. Add 10 drops of 0.1 mol/L NaOH to wells A12, B12, C12, and D12.
4. Transfer 1 drop of hydrochloric acid from well A1 to well A2. Mix by drawing the contents of well A2 into the eyedropper and then returning the liquid to well A2.
5. Transfer 1 drop from well A2 to well A3, again mixing by drawing the contents of well A3 into an eyedropper and returning the contents to well A3. Continue the serial dilution in this manner through to and including well 6.
6. Repeat steps 4 and 5 for rows B, C, and D.
7. Transfer 1 drop of sodium hydroxide solution from well A12 to well A11. Mix by drawing up the contents of well A11 into an eyedropper and then returning the liquid to well A11.
8. Now transfer 1 drop from well A11 to well A10, again mixing by drawing the contents of well A10 into an eyedropper and returning the contents to well A10. Continue the serial dilution in this manner backwards through to and including well 8.
9. Repeat steps 7 and 8 for rows B, C, and D.

You now have 4 rows of diluted solutions containing varying amounts of acid and base, each 1/10th of the acid of the well to its left and 1/10th of the base of the well to its right. Well numbers indicate the approximate pH of the solutions in each well (e.g., well 4 has a pH of 4 and well 9 has a pH of 9).

10. Add 1 drop of universal indicator to each well in row A.
11. Add 1 drop of methyl orange to each well in row B.
12. Add 1 drop of phenolphthalein to each well in row C.
13. Add 1 drop of bromothymol blue to each well in row D.

**Analysis**

1. What is the significance of the colour changes in each row?
2. Which would be a good indicator for general use?
3. Which would be a good indicator for an HCl/NaOH titration? Why?
4. Which would be a poor indicator for an HCl/NaOH titration? Why?

## Appendix 5.3A: Measuring pH: Lab Activity

---

### Introduction

The pH of an aqueous solution can be measured in several ways, including

- with a pH meter, or a pH probe connected to a calculator or microcomputer interface
- with commercially prepared pH paper
- with an acid-base indicator solution

An acid-base indicator is a substance whose colour in solution depends upon the hydronium ion concentration. Acid-base indicators change colour from their acid form to their base form over a specific range of pH.

### Purpose

To determine the colours of three different indicators and a universal indicator (a mixture of indicators) over a range of pH.

### Procedure

1. Place a 96-well microplate on a piece of white paper with the numbered columns on the top and the lettered rows on the left. (The white paper will make the colour changes more visible.)
2. In rows A, C, E, and G, add 9 drops of distilled water to each of the wells 2 through 11.
3. Place 10 drops of a 0.1 mol/L aqueous hydrochloric acid ( $\text{HCl}_{(\text{aq})}$ ) solution in well 1 of rows A, C, E, and G.
4. Place 10 drops of a 0.1 mol/L aqueous sodium hydroxide ( $\text{NaOH}$ ) solution in well 12 of rows A, C, E, and G.
5. Transfer 1 drop of 0.1 mol/L  $\text{HCl}_{(\text{aq})}$  solution from well A1 to well A2. Mix thoroughly by stirring with a new toothpick or a clean glass stirrer. (If a glass stirrer is used, rinse it carefully with distilled water and wipe it on a dry paper towel before reusing it.) Continue by transferring 1 drop from well A2 to well A3, mixing thoroughly. Continue from well to well until you reach well 6. This will be the last acidic dilution.
6. Continue this procedure (serial dilution) for each of the rows C, E, and G.



**Appendix 5.3A: Measuring pH: Lab Activity** *(continued)*

---

7. Repeat the dilution procedure using the 0.1 mol/L NaOH<sub>(aq)</sub> solution in the same rows as the acid dilution, working backwards from well 12 to well 8, making well 8 the last basic dilution. You now have 4 rows each of the diluted acidic and basic solutions. Show that the pH of the acidic solutions are approximately 1, 2, 3, 4, 5, and 6 respectively in wells 1 through 6, and that of the pH of the basic solutions are approximately 9, 10, 11, 12, and 13 respectively in wells 8 through 12.
8. Add 1 drop of universal indicator solution to each well in row A.
9. Add 1 drop of methyl orange indicator solution to each well in row C.
10. Add 1 drop of bromothymol blue indicator solution to each well in row E.
11. Add 1 drop of phenolphthalein indicator solution to each well in row G.
12. Record your observations for each row.
13. Construct a table that correlates the pH range with a colour change.
14. Describe how you could use the results from this experiment to estimate the pH of an aqueous solution.

## Appendix 5.3B: Measuring pH: Lab Activity (Teacher Notes)

---

### Preparation of Indicator Solutions

These solutions can be prepared in advance and remain stable for at least six months.

- **Methyl orange**

Dissolve 0.01 g of methyl orange in 100 mL of distilled water.

- **Bromothymol blue**

Dissolve 0.04 g of the sodium salt of bromothymol blue in 100 mL of distilled water.

- **Phenolphthalein**

Dissolve 0.05 g of phenolphthalein in 50 mL of 95% ethanol, and dilute the resulting solution to 100 mL with distilled water.

### Yamada's Universal Indicator

Dissolve 0.0025 g of thymol blue, 0.06 g of methyl red, 0.030 g of bromothymol blue, and 0.05 g of phenolphthalein in 50 mL of 95% ethanol. Add 0.01 mol/L aqueous sodium hydroxide solution until the mixture is green, and dilute the resulting solution to 100 mL with distilled water.

## Appendix 5.4: Relative Strengths of Acids

Acid	Reaction	$K_a$
Perchloric acid	$\text{HClO}_4 + \text{H}_2\text{O} \rightarrow \text{H}_3\text{O}^+ + \text{ClO}_4^-$	Very large
Hydriodic acid	$\text{HI} + \text{H}_2\text{O} \rightarrow \text{H}_3\text{O}^+ + \text{I}^-$	Very large
Hydrobromic acid	$\text{HBr} + \text{H}_2\text{O} \rightarrow \text{H}_3\text{O}^+ + \text{Br}^-$	Very large
Hydrochloric acid	$\text{HCl} + \text{H}_2\text{O} \rightarrow \text{H}_3\text{O}^+ + \text{Cl}^-$	Very large
Nitric acid	$\text{HNO}_3 + \text{H}_2\text{O} \rightarrow \text{H}_3\text{O}^+ + \text{NO}_3^-$	Very large
Sulphuric acid	$\text{H}_2\text{SO}_4 + \text{H}_2\text{O} \rightarrow \text{H}_3\text{O}^+ + \text{HSO}_4^-$	Very large
Oxalic acid	$\text{HOOC-COOH} + \text{H}_2\text{O} \rightarrow \text{H}_3\text{O}^+ + \text{HOOC-COO}^-$	$5.4 \times 10^{-2}$
Sulphurous acid	$\text{H}_2\text{SO}_3 + \text{H}_2\text{O} \rightarrow \text{H}_3\text{O}^+ + \text{HSO}_3^-$	$1.7 \times 10^{-2}$
Hydrogen sulphate ion	$\text{HSO}_4^- + \text{H}_2\text{O} \rightarrow \text{H}_3\text{O}^+ + \text{SO}_4^{2-}$	$1.3 \times 10^{-2}$
Phosphoric acid	$\text{H}_3\text{PO}_4 + \text{H}_2\text{O} \rightarrow \text{H}_3\text{O}^+ + \text{H}_2\text{PO}_4^-$	$7.1 \times 10^{-3}$
Ferric ion	$\text{Fe}(\text{H}_2\text{O})_6^{3+} + \text{H}_2\text{O} \rightarrow \text{H}_3\text{O}^+ + \text{Fe}(\text{H}_2\text{O})_5(\text{OH})^{2+}$	$6.0 \times 10^{-3}$
Hydrogen telluride	$\text{H}_2\text{Te} + \text{H}_2\text{O} \rightarrow \text{H}_3\text{O}^+ + \text{HTe}^-$	$2.3 \times 10^{-3}$
Hydrofluoric acid	$\text{HF} + \text{H}_2\text{O} \rightarrow \text{H}_3\text{O}^+ + \text{F}^-$	$6.7 \times 10^{-4}$
Nitrous acid	$\text{HNO}_2 + \text{H}_2\text{O} \rightarrow \text{H}_3\text{O}^+ + \text{NO}_2^-$	$5.1 \times 10^{-4}$
Hydrogen selenide	$\text{H}_2\text{Se} + \text{H}_2\text{O} \rightarrow \text{H}_3\text{O}^+ + \text{HSe}^-$	$1.7 \times 10^{-4}$
Chromic ion	$\text{Cr}(\text{H}_2\text{O})_6^{3+} + \text{H}_2\text{O} \rightarrow \text{H}_3\text{O}^+ + \text{Cr}(\text{H}_2\text{O})_5(\text{OH})^{2+}$	$1.5 \times 10^{-4}$
Benzoic acid	$\text{C}_6\text{H}_5\text{COOH} + \text{H}_2\text{O} \rightarrow \text{H}_3\text{O}^+ + \text{C}_6\text{H}_5\text{COO}^-$	$6.6 \times 10^{-5}$
Hydrogen oxalate ion	$\text{HOOC-COO}^- + \text{H}_2\text{O} \rightarrow \text{H}_3\text{O}^+ + \text{OOC-COO}^{2-}$	$5.4 \times 10^{-5}$
Acetic acid	$\text{CH}_3\text{COOH} + \text{H}_2\text{O} \rightarrow \text{H}_3\text{O}^+ + \text{CH}_3\text{COO}^-$	$1.8 \times 10^{-5}$
Aluminum ion	$\text{Al}(\text{H}_2\text{O})_6^{3+} + \text{H}_2\text{O} \rightarrow \text{H}_3\text{O}^+ + \text{Al}(\text{H}_2\text{O})_5(\text{OH})^{2+}$	$1.4 \times 10^{-5}$
Carbonic acid	$\text{H}_2\text{CO}_3 + \text{H}_2\text{O} \rightarrow \text{H}_3\text{O}^+ + \text{HCO}_3^-$	$4.4 \times 10^{-7}$
Hydrogen sulphide	$\text{H}_2\text{S} + \text{H}_2\text{O} \rightarrow \text{H}_3\text{O}^+ + \text{HS}^-$	$1.0 \times 10^{-7}$
Dihydrogen phosphate ion	$\text{H}_2\text{PO}_4^- + \text{H}_2\text{O} \rightarrow \text{H}_3\text{O}^+ + \text{HPO}_4^{2-}$	$6.3 \times 10^{-8}$
Hydrogen sulphite ion	$\text{HSO}_3^- + \text{H}_2\text{O} \rightarrow \text{H}_3\text{O}^+ + \text{SO}_3^{2-}$	$6.2 \times 10^{-8}$
Ammonium ion	$\text{NH}_4^+ + \text{H}_2\text{O} \rightarrow \text{H}_3\text{O}^+ + \text{NH}_3$	$5.7 \times 10^{-10}$
Hydrogen carbonate ion	$\text{HCO}_3^- + \text{H}_2\text{O} \rightarrow \text{H}_3\text{O}^+ + \text{CO}_3^{2-}$	$4.7 \times 10^{-11}$
Hydrogen telluride ion	$\text{HTe}^- + \text{H}_2\text{O} \rightarrow \text{H}_3\text{O}^+ + \text{Te}^{2-}$	$1.0 \times 10^{-11}$
Hydrogen peroxide	$\text{H}_2\text{O}_2 + \text{H}_2\text{O} \rightarrow \text{H}_3\text{O}^+ + \text{HO}_2^-$	$2.4 \times 10^{-12}$
Monohydrogen phosphate ion	$\text{HPO}_4^{2-} + \text{H}_2\text{O} \rightarrow \text{H}_3\text{O}^+ + \text{PO}_4^{3-}$	$4.4 \times 10^{-13}$
Hydrogen sulphide ion	$\text{HS}^- + \text{H}_2\text{O} \rightarrow \text{H}_3\text{O}^+ + \text{S}^{2-}$	$1.2 \times 10^{-15}$
Water	$\text{H}_2\text{O} + \text{H}_2\text{O} \rightarrow \text{H}_3\text{O}^+ + \text{OH}^-$	$1.8 \times 10^{-16}$
Hydroxide ion	$\text{OH}^- + \text{H}_2\text{O} \rightarrow \text{H}_3\text{O}^+ + \text{O}^{2-}$	$< 10^{-36}$
Ammonia	$\text{NH}_3 + \text{H}_2\text{O} \rightarrow \text{H}_3\text{O}^+ + \text{NH}_2^-$	Very small

## Appendix 5.5: Quantitative Analysis: Acid-Base Titration: Lab Activity

---

### Purpose

In this lab activity, students will do the following:

- Standardize a base solution using a stock acid solution by the method of titration.
- Given an unknown mass of a solid acid, prepare a 100 mL aqueous solution of that acid.
- Titrate the unknown acid solution with a base of known concentration and determine the number of grams of solid acid to 0.001 g.

### Procedure

#### Part A

1. Obtain two burettes, placing one on the left for the acid and the other on the right for the base. Before using the burettes, carefully wash them with soap and water, and then rinse them with tap water to remove all soap. Then rinse the burettes with 15 mL portions of distilled water, ensuring there are no air bubbles in the tips of the burettes. Finally, rinse the burettes with several small (10 to 15 mL) aliquots of each solution.
2. Fill one burette with the acid and the other with the base. To determine the initial acid and base volumes, read each burette to the nearest 0.01 mL.
3. Introduce about 10 to 15 mL of acid into a clean 250 mL Erlenmeyer flask, followed by about 10 mL of distilled water to rinse down the sides. Read the volume of the acid burette and record it as the final acid reading. Add about three drops of phenolphthalein indicator to the flask. Use a clean flask for each trial.
4. While continuously swirling the flask, slowly add the base until a pale lasting pink colour persists, indicating the end point.  
**Note:** As the end point is approached, the colour disappears more slowly until finally the pale pink colour persists. Then carefully read the volume from the base burette and record it as the final base volume.
5. Repeat this entire process as many times (minimum 4) as needed to obtain consistency of data to three significant figures for the base concentration.
6. Select the three best trials and record them in a Data Table. Show calculations for each trial. Calculate the average of the three trials. Record this average.

---

**Appendix 5.5: Quantitative Analysis: Acid-Base Titration: Lab Activity (continued)**

---

**Part B**

1. Obtain a vial containing a sample of sulphamic acid with the formula  $\text{H}_2\text{NSO}_3\text{H}$  and a molar mass of 97.09 g/mol.
2. Transfer the solid acid to a 100 mL volumetric flask. Fill half the flask with water and swirl until the solid dissolves completely, and then fill the flask with water exactly to the 100 mL mark. Take great care with the acid sample, as only one sample will be handed out per student. The 100 mL sample is enough for five to eight titrations, which should be enough to complete the determination.
3. Once the acid solution has been prepared, follow the procedure used for Part A of this experiment. This time, however, use the sulphamic acid instead of the hydrochloric acid and a new standard base stock solution. The concentration of the base can be read off the stock solution.
4. Select three of the best trials and record them in a Data Table. Calculate the mass to 0.001 g.

**Calculations and Questions**

1. Record the values of the acid and base volumes from Part A in the Titration Data Table provided on the following page.
2. Calculate the concentration of the base used. Show all work.
3. Record the values of the acid and base values from Part B in the Titration Data Table provided.
4. Calculate the concentration of the sulphamic acid in the sample. Show all work.
5. Calculate the mass of the sample of sulphamic acid. Present the average of the best three trials. Show all work.
6. When an end point is reached in an acid-base titration, what does this indicate about the concentration of the  $[\text{H}_3\text{O}^+]$  and  $[\text{OH}^-]$ ?
7. What would you expect the pH of the solution to be just at the point at which the phenolphthalein turns pink?
8. Why is an indicator solution so important to use for titrations?
9. What does the following statement mean? "The relative volumes required in a titration vary inversely with the concentrations of the solutions."

## Appendix 5.5: Quantitative Analysis: Acid-Base Titration: Lab Activity (continued)

<b>Titration Data Table (Part A)</b>			
<b>Trial</b>	<b>Burette Reading</b>	<b>Acid</b>	<b>Base</b>
1	Final burette reading		
	Initial burette reading		
	Total volume		
2	Final burette reading		
	Initial burette reading		
	Total volume		
3	Final burette reading		
	Initial burette reading		
	Total volume		
4	Final burette reading		
	Initial burette reading		
	Total volume		
5	Final burette reading		
	Initial burette reading		
	Total volume		
6	Final burette reading		
	Initial burette reading		
	Total volume		
7	Final burette reading		
	Initial burette reading		
	Total volume		
8	Final burette reading		
	Initial burette reading		
	Total volume		

## Appendix 5.5: Quantitative Analysis: Acid-Base Titration: Lab Activity (continued)

Titration Data Table (Part B)			
Trial	Burette Reading	Acid	Base
1	Final burette reading		
	Initial burette reading		
	Total volume		
2	Final burette reading		
	Initial burette reading		
	Total volume		
3	Final burette reading		
	Initial burette reading		
	Total volume		
4	Final burette reading		
	Initial burette reading		
	Total volume		
5	Final burette reading		
	Initial burette reading		
	Total volume		
6	Final burette reading		
	Initial burette reading		
	Total volume		
7	Final burette reading		
	Initial burette reading		
	Total volume		
8	Final burette reading		
	Initial burette reading		
	Total volume		

## Appendix 5.6: Analysis of Household Vinegar: Lab Activity

### Purpose

To determine the percent of acetic acid by mass of household vinegar.

### Introduction

Vinegar contains acetic acid ( $\text{HC}_2\text{H}_3\text{O}_2$ ) as the active ingredient. Most vinegar samples contain 5% acetic acid.

### Procedure

1. Pipette 5.0 mL of the vinegar sample into a 250 mL Erlenmeyer flask. Add 25 mL of distilled water to the flask. Add two or three drops of phenolphthalein indicator solution.
2. Rinse the burette and fill it with the standardized solution of sodium hydroxide. Record the level of the solution in the burette.
3. Slowly add the base solution from the burette to the flask containing the vinegar, swirling the flask. When the pink colour starts to disappear more slowly, begin adding the base solution a drop at a time.
4. Stop the titration when the first trace of faint pink remains for 20 to 30 seconds after swirling. Wait about 30 seconds, and then record the level in the burette, estimating to within half the smallest gradation (e.g., 0.01, 0.02, 0.05).
5. Repeat the titration until you can reproduce the volume added to  $\pm 0.1$  mL.
6. Make the calculations necessary to complete the following Data Table. Assume the density of vinegar is  $1.00 \text{ g mL}^{-1}$ .

### Data Table

		Trial 1	Trial 2	Trial 3
Burette reading	Final reading			
	Initial reading			
	Volume used			
Concentration of standardized NaOH				



Appendix 5.6: Analysis of Household Vinegar: Lab Activity (*continued*)

---

**Calculations**Chemical amount (moles)  
of  $\text{HC}_2\text{H}_3\text{O}_2$  in sample:

---

Mass of  $\text{HC}_2\text{H}_3\text{O}_2$  in sample:

---

Percent of  $\text{HC}_2\text{H}_3\text{O}_2$  by mass:

---

## Appendix 5.7: Analysis of Aspirin: Lab Activity

### Introduction

Acetylsalicylic acid, sometimes abbreviated as ASA, is the active ingredient in Aspirin. The structural formula of ASA is given below.

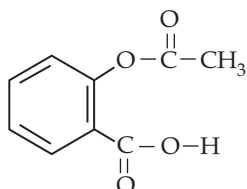

Pure ASA can be synthesized by treating salicylic acid with acetic anhydride in the presence of a trace of either sulphuric or phosphoric acids.

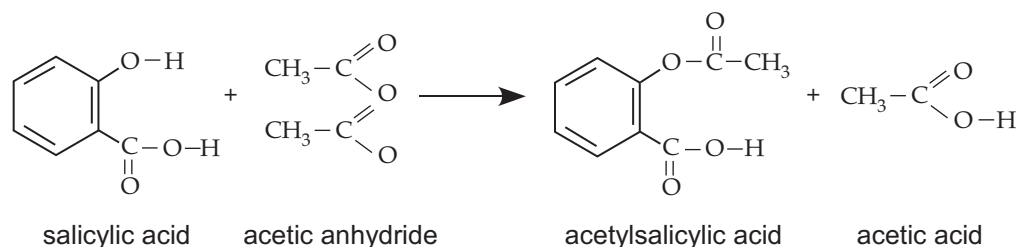

The product is removed from the reaction mixture by crystallization. The crude ASA must be purified by washing to remove excess by-products and then re-crystallized in the pure state.

Aspirin tablets are made by blending the pure ASA with filler (inert material), which gives body to the tablets so that they can be pressed and shaped.

### Purpose

The purpose of this analysis is to determine the degree of purity of various commercial ASA products. The analysis is based on titration of the ASA tablets with a standard sodium hydroxide solution. During this reaction,  $H^+$  ion is transferred from the acid to the reacting base,  $OH^-$ . The following equation illustrates the reaction:

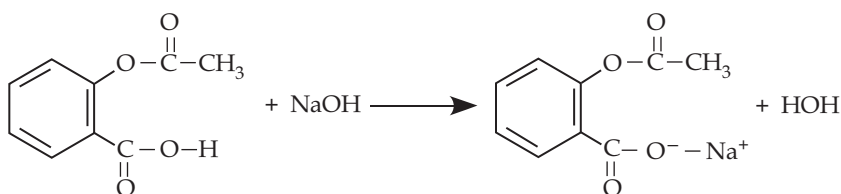

Titration is continued until an end point is reached, as indicated by the phenolphthalein indicator. The percent of ASA present can then be calculated.

**Appendix 5.7: Analysis of Aspirin: Lab Activity** *(continued)*

---

**Procedure**

1. Determine the mass of a single ASA tablet to the nearest 0.01 g by direct weighing.
2. Place the tablet in a 250 mL conical flask and add approximately 15 mL of water and 15 mL of ethanol (ethyl alcohol). Use a glass rod to crush the tablet. Agitate the solution to dissolve the tablet. Complete solution may not be accomplished prior to titration with the base solution.
3. Add approximately three drops of phenolphthalein indicator solution. No colour change should be seen.
4. Carefully fill a 50 mL burette with standard 0.1 mol/L sodium hydroxide solution. Record the exact concentration of the standard sodium hydroxide solution.
5. Record the level of sodium hydroxide solution in the burette. Place the flask containing the ASA sample under the burette.
6. Add small volumes of sodium hydroxide solution, while swirling the flask. Continue adding sodium hydroxide solution until the first indication that a phenolphthalein end point has been reached, as indicated by a light pink colour throughout the solution in the flask. This colour should remain without fading upon swirling.
7. Record the level of the solution in the burette.

**Calculations**

Calculate the percent of ASA in your tablet. The formula mass of ASA is 180 g/mol, and each molecule transfers 1 hydrogen ion to a base.

## Appendix 5.8: Potentiometric Analysis of Acid in Soft Drinks: Cola versus Non-cola: Lab Activity

### Introduction

Phosphoric acid is a common ingredient in cola drinks; it provides a taste that is both sweet and sour, but does not compete with other flavours. There is some variability in both the amount and composition of the acid in cola drinks. The composition is affected by the equilibrium

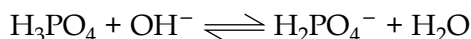

### Purpose

In this experiment, you will determine the  $\text{H}_3\text{PO}_4$  and  $\text{H}_2\text{PO}_4^-$  in a sample of cola drink using a potentiometric titration. A potentiometric detection method is preferred over an acid-base indicator for two reasons:

- The colour of the cola obscures indicator changes.
- The use of a pH meter permits a more accurate location of the equivalence points in a titration than an indicator.

You will also determine the citric acid concentration in a non-cola drink. Citric acid, which is also tri-basic, is another common ingredient in many soft drinks. The acid dissociation constants for phosphoric and citric acids are as follows:

Dissociation Constant	Phosphoric Acid	Citric Acid
$K_1$	$7.11 \times 10^{-3}$	$7.44 \times 10^{-4}$
$K_2$	$6.32 \times 10^{-8}$	$1.73 \times 10^{-5}$
$K_3$	$7.10 \times 10^{-13}$	$4.02 \times 10^{-7}$

From these data, it is clear that the constants for phosphoric acid are more than a factor of 1000 apart, and three distinct end points can, therefore, be observed in a titration. In contrast, the citric acid constants are closer together and the titration has no definite breaks between the end points. Moreover, several of the citric and phosphoric acid end points are close, so it is advisable to carry out this experiment with soft drinks that do not contain both phosphoric and citric acid. A possible choice is using Coca-Cola for the phosphoric acid determination, and Squirt for the citric acid determination. If you choose other brands, read the list of ingredients to make sure that only one or the other of the acids is present. The drinks also should not contain lactic acid or aspartame (e.g., NutraSweet), so do not choose diet drinks.

---

**Appendix 5.8: Potentiometric Analysis of Acid in Soft Drinks:  
Cola versus Non-cola: Lab Activity (continued)**

---

The potentiometric response of the glass electrode is described by the equation

$$E_{\text{glass}} = k - 0.059 \text{ pH}$$

where  $k$  is a constant. Clearly, there is a simple linear relationship between the measured potential and the pH of the solution. For convenience, the pH meter is calibrated in pH units, so that the appropriate values can be read off directly.

You will calibrate the meter with pH 4 and 7 (or 10) buffers, following the instructions that are provided with the pH meter. Once the meter is calibrated, the pH of the  $\text{H}_3\text{PO}_4$  solution is easily followed as a function of added NaOH.

At pH 10.5 to 11, the glass electrode begins to respond to other ions (mainly  $\text{Na}^+$  in this case) since so few  $\text{H}_3\text{O}^+$  ions remain. This effect, which makes it appear that the pH is lower than it really is, is called the *alkaline error*. Its occurrence makes it advisable not to carry the titration beyond pH 10.5, meaning that you will not observe the third equivalence point of phosphoric acid:

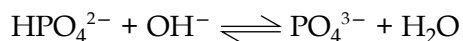
**Pre-laboratory Assignment**

The phosphoric acid in a 100 mL sample of cola drink was titrated with 0.1025 N NaOH. If the first equivalence point occurred after 13.11 mL of base was added, and the second equivalence point occurred after 28.55 mL of base was added, calculate the concentrations of  $\text{H}_3\text{PO}_4$  and  $\text{H}_2\text{PO}_4^-$  in the cola sample. (**Hint:** Where would the second equivalence point have occurred if only  $\text{H}_3\text{PO}_4$  were present?)

**Apparatus**

stirrer and (large) stir bar  
pH meter and glass electrode  
two 250 mL beakers  
50 mL burette  
25 mL pipette  
1000 mL bottle  
25 mL graduated cylinder  
1000 mL boiling flask  
stirring rod  
400 mL beaker  
watch glass

**Appendix 5.8: Potentiometric Analysis of Acid in Soft Drinks:  
Cola versus Non-cola: Lab Activity (continued)**

---

**Chemicals**

sodium hydroxide  
primary standard – potassium hydrogen phthalate (KHP)  
cola unknown (e.g., Coca-Cola)  
non-cola unknown (e.g., Squirt)  
pH 4 and 7 buffers  
phenolphthalein indicator

**Procedure**

1. Standardize the pH meter with the buffers.
2. Prepare a standard 0.10 N NaOH solution (using a KHP primary standard). For the titration, use the pH electrode in conjunction with the phenolphthalein indicator and compare the electrode response to the indicator colour change. Add small increments of titrant, reading both the stabilized pH value and the total volume added after each addition. Initially, the additions should be large enough to cause pH changes of about 0.2 units. When the pH starts to change rapidly, reduce the size of the NaOH aliquots. As you near the equivalence point, the pH will change considerably upon the slightest addition of base. To develop the entire titration curve (pH versus volume of titrant), you need to proceed somewhat beyond the equivalence point. The electrode response will be the principal indicator of the end point in this experiment, but you should observe that the indicator changes colour at the point where the greatest pH change occurs (note this volume). Any difference is called the *indicator error*. It should be small. Stop the titration at pH 10.5.
3. Add 100 mL of cola to a 250 mL beaker and cover it with a clean watch glass. Bring the solution just to boiling and keep it warm for five minutes. This will expel the CO<sub>2</sub> which otherwise would interfere with the titration of H<sub>3</sub>PO<sub>4</sub>. Cool the solution by placing ~200 mL of cold water in a 400 mL beaker and carefully resting the beaker with the cola in the cold water.
4. Rinse the electrodes. Refill the burette with the NaOH.
5. Place the glass electrode in the beaker. Add the stir bar and enough water to cover the electrode. Start the stirrer.
6. Proceed with the titration of the cola solution as you did for the NaOH standardization (except that there is no indicator here). Expect two equivalence points, one near pH 4 and the other near pH 8. Continue to pH 10.5.
7. Repeat steps 3 to 6 with the non-cola. Now only one equivalence point should be found, near pH 6.

---

**Appendix 5.8: Potentiometric Analysis of Acid in Soft Drinks:  
Cola versus Non-cola: Lab Activity (continued)**

---

**Calculations**

1. Plot pH (ordinate, i.e.,  $y$ -axis) versus volume of NaOH (abscissa, i.e.,  $x$ -axis) for the standardization and the two unknowns.
2. Construct first-derivative plots for these titrations. This is accomplished by plotting  $(\text{pH}_2 - \text{pH}_1)/(V_2 - V_1)$  versus  $(V_1 + V_2)/2$ , where  $V_1$  and  $V_2$  are two successive titration volumes (totals) and  $\text{pH}_1$  and  $\text{pH}_2$  are the corresponding pH values. These plots have peaks where the original graphs have inflection points (i.e., the end points of the titrations). Use them to estimate the equivalence points.
3. Calculate the molarity of the titrant.
4. Use the equivalence point volumes obtained for the cola titration, along with the NaOH molarity, to calculate the moles of  $\text{H}_3\text{PO}_4$  present. Remember that at the first equivalence point, one proton has been titrated, while at the second equivalence point, two protons have reacted. If your results show that  $V_{\text{eq}2} > 2V_{\text{eq}1}$ , then not only  $\text{H}_3\text{PO}_4$  but also  $\text{H}_2\text{PO}_4^-$  was present in the drink (see Pre-laboratory Assignment). Calculate the concentrations of both.
5. Calculate the concentration of citric acid in the non-cola.

**Questions**

1. In the phosphoric acid titration, could  $V_{\text{eq}2} < 2V_{\text{eq}1}$ ? Explain.
2. Assume that you could titrate to the third equivalence point of  $\text{H}_3\text{PO}_4$ . What would be the relationship of  $V_{\text{eq}3}$  to  $V_{\text{eq}2}$  and  $V_{\text{eq}1}$ ?
3. What is the structure of citric acid? Draw a simple molecular diagram.
4. How could  $\text{CO}_2$  interfere with the titration of  $\text{H}_3\text{PO}_4$ ?
5. The glass electrode that you used appears to be a single device, while it is actually two electrodes. Explain.

## Appendix 5.8: Potentiometric Analysis of Acid in Soft Drinks: Cola versus Non-cola: Lab Activity (continued)

### Extension Activity

Determination of acid in soft drink

### Purpose

Specify the purpose.

### Procedure

Explain the procedure used to prepare the cola and non-cola samples.

### Calculations

#### A. Titration of NaOH and KHP

Concentration of KHP: \_\_\_\_\_ mol/L

Volume of NaOH at equivalence point: \_\_\_\_\_ mL

Concentration of NaOH: \_\_\_\_\_ mol/L

Plot pH versus volume of NaOH for this titration, using graph paper. Label the equivalence point.

#### B. Data for titration of cola and non-cola with NaOH

Make a data table with the following columns:

##### Data Table

Vol. NaOH Added	pH	$V_2 - V_1$	$\text{pH}_2 - \text{pH}_1$	$\frac{(V_1 + V_2)}{2}$	$\frac{\text{pH}_2 - \text{pH}_1}{V_2 - V_1}$
-----------------	----	-------------	-----------------------------	-------------------------	---

Plot the first-derivative plots using the above data.

#### C. Results

Cola: Volume of first equivalence point: \_\_\_\_\_ mL      pH: \_\_\_\_\_

Volume of second equivalence point: \_\_\_\_\_ mL      pH: \_\_\_\_\_

Molarity of  $\text{H}_3\text{PO}_4$ : \_\_\_\_\_ mol/L

Molarity of  $\text{H}_2\text{PO}_4^-$ : \_\_\_\_\_ mol/L

Non-cola: Volume of equivalence point: \_\_\_\_\_ mL      pH: \_\_\_\_\_

Molarity of citric acid: \_\_\_\_\_ mol/L



## Appendix 5.9: Samples of Various Titration Curves (Teacher Notes)

Plotting the pH of the solution during an acid-base titration generates a titration curve. The general shape of the curves generated in a series of titrations may be grouped into families, according to the solution titrated and the titrating solutions. Typical examples of the general shapes for four classes of titration are illustrated below. Some learning activities follow the examples.

### 1. A Solution of a Strong Acid Titrated with a Solution of a Strong Base

In this example, 25.0 mL of a 0.100 mol/L aqueous solution of hydrochloric acid, HCl (a monoprotic strong acid), is titrated with a 0.100 mol/L aqueous solution of sodium hydroxide, NaOH<sub>(aq)</sub> (an ionic hydroxide). The equation representing the reaction may be written as

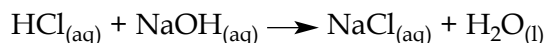

or as the net ionic equation

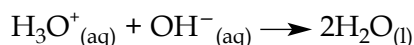

At equivalence, moles HCl originally present = moles NaOH added.

Volume HCl original  $\times$  concentration HCl solution = Volume NaOH added  $\times$  concentration NaOH solution.

At equivalence,  $[\text{H}_3\text{O}^+] = [\text{OH}^-]$  and  $[\text{Na}^+] = [\text{Cl}^-]$ . Since Na<sup>+</sup><sub>(aq)</sub> is a weaker acid than water and Cl<sup>-</sup> is a weaker base than water, the solution is described as neutral. At 25°C, the pH will be 7.0 (under the usual set of assumptions).

The expected titration curve is shown in Figure 1 below.

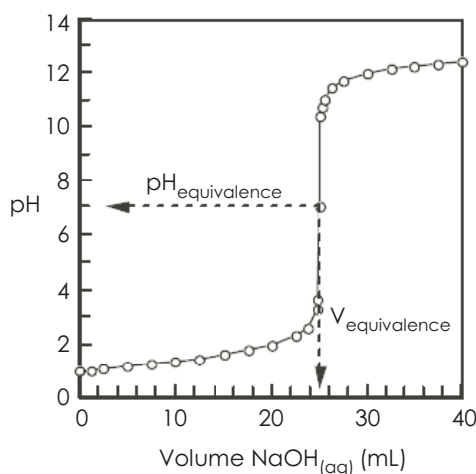

**Figure 1:** 0.1 mol/L HCl<sub>(aq)</sub> versus 0.1 mol/L NaOH<sub>(aq)</sub>

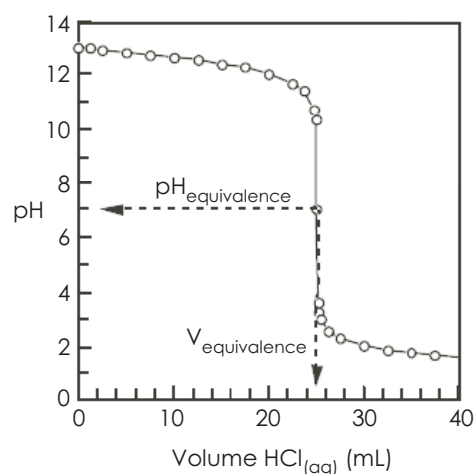

**Figure 2:** 0.1 mol/L NaOH<sub>(aq)</sub> versus 0.1 mol/L HCl<sub>(aq)</sub>

**Appendix 5.9: Samples of Various Titration Curves (continued)**

---

**2. A Solution of a Strong Base Titrated with a Solution of a Strong Acid**

This titration is analogous to the strong acid and strong base titration, except that the acid is the independent variable (i.e., is added from a burette or equivalent). The example chosen is the titration of 25.0 mL of a 0.100 mol/L aqueous solution of sodium hydroxide with a 0.100 mol/L solution of hydrochloric acid. The expected titration curve is shown in Figure 2 on the previous page.

For both examples 1 and 2, the end point (assumed the equivalence point) is found at the steepest part of the curve, the inflection point where the curve changes direction.

**3. A Solution of a Weak Acid Titrated with a Solution of a Strong Base**

In this example, 25 mL of a 0.100 mol/L aqueous solution of acetic acid,  $\text{HCH}_3\text{CO}_2$  (a monoprotic weak acid with  $K_a = 1.8 \times 10^{-5}$  mol/L), is titrated with a 0.100 mol/L aqueous solution of sodium hydroxide,  $\text{NaOH}_{(\text{aq})}$  (an ionic hydroxide). The equation representing the reaction may be written as

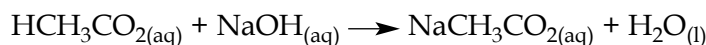

or as the net ionic equation

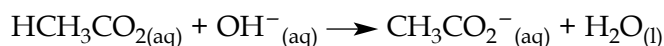

For a weak acid, the acid of highest concentration in an aqueous solution is the undissociated acid, not the hydronium ion.

At equivalence, moles  $\text{HCH}_3\text{CO}_2$  originally present = moles  $\text{NaOH}$  added.

At equivalence,  $[\text{HCH}_3\text{CO}_2] = [\text{OH}^-]$  and  $[\text{NA}^+] = [\text{CH}_3\text{CO}_2^-]$ . Since  $\text{NA}^+_{(\text{aq})}$  is a weaker acid than water and  $\text{CH}_3\text{CO}_2^-$  is a stronger base than water, the solution will be basic. At 25°C, the pH will be greater than 7.0 (under the usual set of assumptions).

## Appendix 5.9: Samples of Various Titration Curves (continued)

The expected titration curve is shown in Figure 3a below.

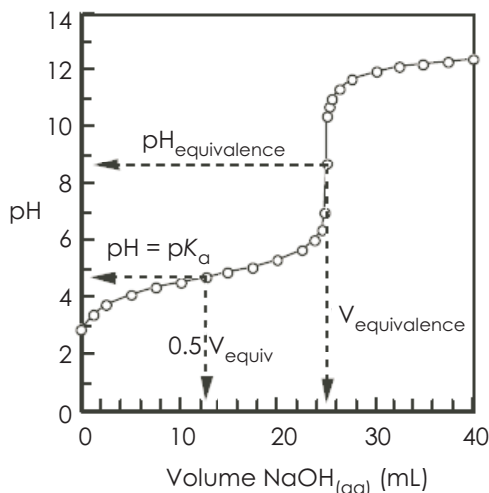

**Figure 3a:** 0.1 mol/L HOAc<sub>(aq)</sub> versus  
0.1 mol/L NaOH<sub>(aq)</sub>

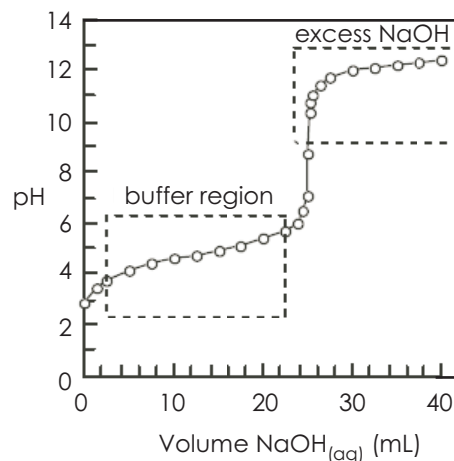

**Figure 3b:** 0.1 mol/L HOAc<sub>(aq)</sub> versus  
0.1 mol/L NaOH<sub>(aq)</sub>

The end point (assumed the equivalence point) is found at the steepest part of the curve, the inflection point where the curve changes direction.

In a titration of a weak acid with a strong base (or of a weak base with a strong acid, example 4), the region between about 10% and 90% of the equivalence volume added is described as the *buffer region* (Figure 3b). In this region, both undissociated acid and its conjugate base (the anion) are present in appreciable concentrations, and the pH does not change appreciably as more hydroxide ion is added to the mixture. (A mixture of a weak acid and its conjugate base, or of a weak base and its conjugate acid, are the common descriptions for a buffer solution.)

At the half-equivalence volume ( $0.5 V_{\text{equivalence}}$ ),  $[\text{HCH}_3\text{CO}_2] = [\text{CH}_3\text{CO}_2^-]$  and  $K_a = [\text{H}_3\text{O}^+]$ . Thus,  $\text{pH} = \text{p}K_a$ .

## Appendix 5.9: Samples of Various Titration Curves (continued)

## 4. A Solution of a Weak Base Titrated with a Solution of a Strong Acid

This titration is analogous to the weak acid and strong base titration, except that the acid is the independent variable (i.e., is added from a burette or equivalent). The example chosen is the titration of 25.0 mL of a 0.100 mol/L solution of aqueous ammonia ( $K_b = 1.8 \times 10^{-5}$  mol/L) with a 0.100 mol/L solution of hydrochloric acid. The expected titration curve is shown in Figure 4 below.

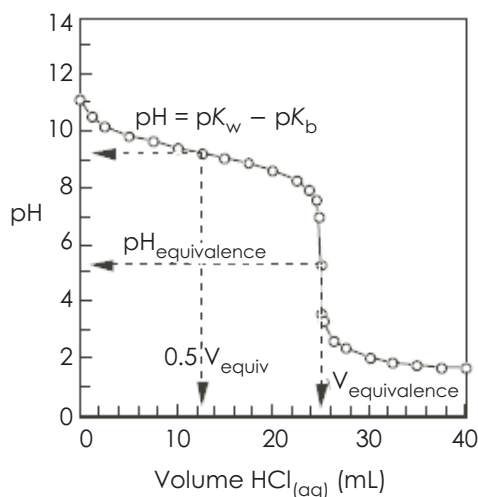

**Figure 4:** 0.1 mol/L  $\text{NH}_3(\text{aq})$  versus  
0.1 mol/L  $\text{HCl}(\text{aq})$

The end point (assumed the equivalence point) is found at the steepest part of the curve, the inflection point where the curve changes direction.

At the half-equivalence volume,  $[\text{NH}_4^+] = [\text{NH}_3]$  and  $[\text{H}_3\text{O}^+] = K_a$  for the conjugate acid  $\text{NH}_4^+$ . Since, for a conjugate acid-base pair,  $K_a = K_w/K_b$ , at half-equivalence,  $\text{pH} = \text{p}K_w - \text{p}K_b$ .

## Appendix 5.9: Samples of Various Titration Curves (continued)

### Selecting an Indicator

A suitable indicator of a titration should change colour at the equivalence point of the titration. Indicators do not change abruptly but rather over a pH range. Some typical acid-base indicators are given in the table below.

Acid-Base Indicators		
Indicator	Colour Change	pH Range
Bromocresol green	Yellow → blue	3.6 – 5.2
Methyl red	Red → yellow	4.8 – 6.0
Bromothymol blue	Yellow → blue	6.0 – 7.6
Phenol red	Yellow → red	6.8 – 8.4
Phenolphthalein	Colourless → pink	8.0 – 9.8

For an effective end point, one drop (0.02 mL) of titrant should change the colour of the indicator solution. Select an indicator that changes just past the equivalence point but still within the steepest portion of the titration curve. (You also need to be able to see the change—some people are colour blind and don't recognize red-green changes, for example, and others have difficulty seeing changes such as pink to colourless.)

For the model titrations shown, suitable indicators might include the following:

- HCl versus NaOH: any bromothymol blue, phenol red, or phenolphthalein
- NaOH versus HCl: any of bromocresol green, methyl red, or bromothymol blue
- HOAc versus NaOH: phenolphthalein
- NH<sub>3</sub> versus HCl: methyl red or bromocresol green

**Note:** For accuracy, it is beneficial to titrate both HCl versus NaOH and NaOH versus HCl with different indicators.

## Appendix 5.9: Samples of Various Titration Curves (continued)

## Learning Activity 1

A student pipetted 25.0 mL of an aqueous solution of an unknown acid into a conical flask, added 25.0 mL of water, and then titrated the resulting mixture with a standard 0.0985 mol/L solution of aqueous sodium hydroxide, measuring the pH of the mixture after each addition. The following graph shows the titration curve obtained.

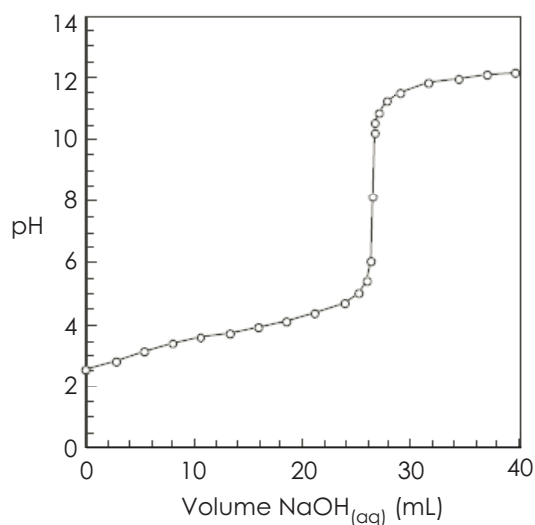

Using this graph, answer the following questions:

1. What was the concentration of the unknown acid solution?
2. What would be a suitable indicator for this solution?
3. Assuming the unknown acid is a weak monoprotic acid, estimate its  $K_a$  value.

## Appendix 5.9: Samples of Various Titration Curves (continued)

## Learning Activity 2

A student weighed 0.225 g of a solid unknown acid into a conical flask, added about 50.0 mL of water, and then titrated the resulting mixture with a standard 0.1245 mol/L solution of aqueous sodium hydroxide, measuring the pH of the mixture after each addition. The following graph shows the titration curve obtained.

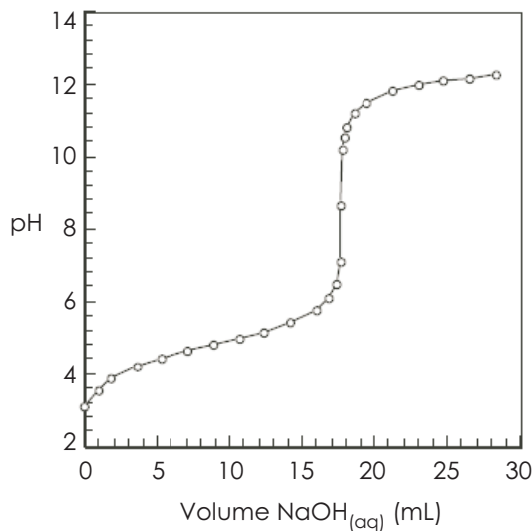

Using this graph, answer the following questions:

1. What would be a suitable indicator for this solution?
2. Assuming the unknown acid is a weak monoprotic acid, estimate its  $K_a$  value.
3. Estimate the molar mass of the unknown acid.
4. Would the results obtained have been different if the student had added 100 mL of water? Explain.

## Appendix 5.9: Samples of Various Titration Curves (continued)

## Learning Activity 3

A student weighed 0.0165 g of a solid unknown base into a conical flask, added about 100 mL of water, and then titrated the resulting mixture with a standard 0.02635 mol/L solution of hydrochloric acid, measuring the pH of the mixture after each addition. The following graph shows the titration curve obtained.

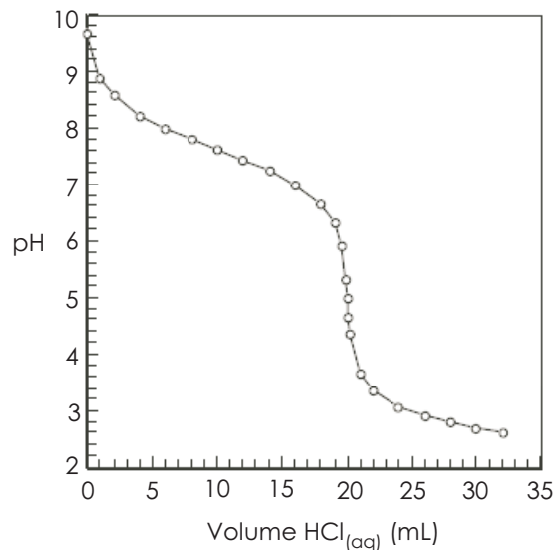

Using this graph, answer the following questions:

1. What would be a suitable indicator for this solution?
2. Assuming the unknown base is a weak monoprotic base, estimate its  $K_b$  value. Estimate the  $K_a$  of its conjugate acid.
3. Estimate the molar mass of the unknown base.



**TOPIC 6:**  
**ELECTROCHEMISTRY**

---



## Topic 6: Electrochemistry

- C12-6-01** Develop an activity series experimentally.
- C12-6-02** Predict the spontaneity of reactions using an activity series.
- C12-6-03** Outline the historical development of voltaic (galvanic) cells.  
Include: contributions of Luigi Galvani and Alessandro Volta
- C12-6-04** Explain the operation of a voltaic (galvanic) cell at the visual, particulate, and symbolic levels.  
Include: writing half-cell reactions, the overall reaction, and shorthand (line) notation
- C12-6-05** Construct a functioning voltaic (galvanic) cell and measure its potential.
- C12-6-06** Define *standard electrode potential*.  
Include: hydrogen electrode as a reference
- C12-6-07** Calculate standard cell potentials, given standard electrode potentials.
- C12-6-08** Predict the spontaneity of reactions using standard electrode potentials.
- C12-6-09** Compare and contrast voltaic (galvanic) and electrolytic cells.
- C12-6-10** Explain the operation of an electrolytic cell at the visual, particulate, and symbolic levels.  
Include: a molten ionic compound and an aqueous ionic compound
- C12-6-11** Describe practical uses of electrolytic cells.  
*Examples: electrolysis of water, electrolysis of brine, electroplating, production and purification of metals . . .*
- C12-6-12** Solve problems related to electrolytic cells, using Faraday's law.

**Suggested Time: 14 hours**

## Topic 6: Electrochemistry

### SPECIFIC LEARNING OUTCOMES

C12-6-01: Develop an activity series experimentally.

C12-6-02: Predict the spontaneity of reactions using an activity series.

(2 hours)

SLO: C12-6-01  
SLO: C12-6-02

### SUGGESTIONS FOR INSTRUCTION

#### Entry-Level Knowledge

In Topic 1: Reactions in Aqueous Solutions, students were introduced to oxidation and reduction reactions. Given an oxidation-reduction reaction, students should now be able to identify the oxidation numbers of all the elements in a given reaction, the element being oxidized, the element being reduced, and the oxidizing and reducing agents. Students should also be able to balance oxidation-reduction reactions and have a good understanding of the concept of the conservation of electrons. If students are not able to perform these tasks adequately, they will have difficulty understanding electrochemistry. Review redox information from Topic 1, as necessary.

If students were asked to research practical applications of oxidation-reduction in Topic 1 (C12-1-12), give them time to present their findings in Topic 6.

#### TEACHER NOTES

##### Standard Reduction Potentials

Many chemistry texts use the SI system to present tables of Standard Reduction Potentials in which the half-reaction at the top of the tables is the lithium ion being reduced to the lithium atom, with the fluorine reduction half-reaction placed at the bottom of the tables.

The tendency for a substance to gain electrons is referred to as its *reduction potential* ( $E^0$ ). Because each reduction must be coupled with an oxidation, scientists decided on a standard substance against which they could measure reduction potential. Hydrogen was chosen; thus, the hydrogen half-reaction shows up in all Standard Reduction Potentials tables as 0 volts. The rest of the table is experimentally determined by reacting substances with hydrogen at concentrations of 1 mol/L at standard temperature and pressure.

#### General Learning Outcome Connections

- GLO B3:** Identify the factors that affect health, and explain the relationships among personal habits, lifestyle choices, and human health, both individual and social.
- GLO B5:** Identify and demonstrate actions that promote a sustainable environment, society, and economy, both locally and globally.
- GLO C1:** Recognize safety symbols and practices related to scientific and technological activities and to their daily lives, and apply this knowledge in appropriate situations.
- GLO C2:** Demonstrate appropriate scientific inquiry skills when seeking answers to questions.
- GLO C5:** Demonstrate curiosity, skepticism, creativity, open-mindedness, accuracy, precision, honesty, and persistence, and appreciate their importance as scientific and technological habits of mind.

**SKILLS AND ATTITUDES OUTCOMES**

**C12-0-S1:** Demonstrate work habits that ensure personal safety and the safety of others, as well as consideration for the environment.

Include: knowledge and use of relevant safety precautions, Workplace Hazardous Materials Information System (WHMIS), and emergency equipment

**C12-0-S5:** Collect, record, organize, and display data using an appropriate format.

Examples: labelled diagrams, graphs, multimedia applications, software integration, probeware . . .

**What to Remember When Using a Table of Standard Reduction Potentials**

1. Electrode potentials depend on the concentration of the reactants and products, not on the quantity. This means that stoichiometric coefficients do not alter the voltage of a half-reaction.

Examples:



2. Half-reactions are listed as reductions.
3. Half-reactions can occur in either direction. Reversing the direction makes the reaction an oxidation and reverses the sign of  $E^0$ .
4. A positive value for  $E^0$  means that the substance is easily reduced. The more positive the value is, the easier it is to reduce. Conversely, the more negative a number is, the easier it is to oxidize.
5. A negative value for  $E^0$  means that the substance is not easily reduced. The more negative the value is, the more likely it is to be oxidized.
6. A substance with a more positive value for  $E^0$  will oxidize a substance that is less positive on the Standard Reduction Potentials table. In other words, a substance on the reactant side of any half-reaction can oxidize a substance that is on the product side of a more negative  $E^0$  half-reaction.

**Note:**

- Depending on which resources you use, **electrode potentials** tables may be listed as oxidation potentials and may list all the reactions as oxidation half-reactions. Also, some tables list more positive values for  $E^0$  at the top, while others list more negative values at the top. This document uses **reduction potentials**, with more positive values for  $E^0$  at the top. See Appendix 6.1: Activity Series: Lab Activity.
- Remember that  $-1.0 \text{ V}$  is more positive than  $-2.0 \text{ V}$ , and  $+1.0 \text{ V}$  is more negative than  $+2.0 \text{ V}$ .

**Representations of Electrochemistry**

Electrochemistry is ideally suited to discussions about what is occurring in the visual, particulate, and symbolic modes of representation. Current research shows that students gain a better understanding of chemical processes when these modes of representation are discussed and illustrated. Once students have experienced visual (macroscopic) changes in the laboratory, ask them to draw and explain what is happening at the particulate/molecular (microscopic) level. Any animations used to illustrate what is occurring at the molecular level will also increase students' understanding of the processes involved.

**Topic 6:  
Electrochemistry****SPECIFIC LEARNING OUTCOMES**

C12-6-01: Develop an activity series experimentally.

C12-6-02: Predict the spontaneity of reactions using an activity series.

*(continued)*

---

**Animations/Simulations**

Have students use online resources to perform simulations or to view animations of electrochemistry.

*Sample Websites:*

Chemical Education Research Group, Iowa State University. "Chemistry Experiment Simulations and Conceptual Computer Animations." *Chemical Education*. <<http://group.chem.iastate.edu/Greenbowe/sections/projectfolder/simDownload/index4.html>> (22 Nov. 2012).

In the Electrochemistry section, download and unzip the following simulation:

- Reactions of Metals and Metal Ions Experiment

In this simulation, students discover the activity series by placing different metals in various aqueous solutions. Students can observe the simulation at the molecular level.

Virtual Crezlab Qualitative Analysis. "Displacement Reaction." *Teaching Laboratory*. Crescent Girls' School.

<[www.crescent.edu.sg/crezlab/webpages/pptReaction3.htm](http://www.crescent.edu.sg/crezlab/webpages/pptReaction3.htm)> (3 Apr. 2012).

This animation shows the displacement reaction between aqueous copper(II) sulphate solution,  $\text{CuSO}_4(\text{aq})$ , and zinc metal,  $\text{Zn}(\text{s})$ .

**Laboratory Activity**

For learning outcomes C12-6-01 and C12-6-02, students are required to perform an experiment or investigation that shows, qualitatively, how an activity series is derived. Most chemistry textbooks and resource manuals outline an experiment that uses metals such as Zn, Cu, Pb, Fe, and even Ag, with their corresponding ions. By reacting solid metals with aqueous ions of other metals, students can record their observations and rank them from most to least reactive. For a suggested experiment, refer to Appendix 6.1: Activity Series: Lab Activity.

**SKILLS AND ATTITUDES OUTCOMES**

**C12-0-S1:** Demonstrate work habits that ensure personal safety and the safety of others, as well as consideration for the environment.

Include: knowledge and use of relevant safety precautions, Workplace Hazardous Materials Information System (WHMIS), and emergency equipment

**C12-0-S5:** Collect, record, organize, and display data using an appropriate format.

Examples: labelled diagrams, graphs, multimedia applications, software integration, probeware . . .

**Journal Writing**

Have students

- research the origin of the name *electromotive series*
- discuss the importance of the electromotive series
- relate position on the Standard Reduction Potentials table to chemical reactivity, as discussed in Grade 10 Science or Grade 11 Chemistry

**Visual Displays**

Have students draw representations of reactants and products (or redox reactions) and show how the transfer of electrons occurs in solution.

**SUGGESTIONS FOR ASSESSMENT****Laboratory Skills**

Students should exhibit appropriate lab skills at all times during the lab activity.

Sample checklists for assessing students' lab skills and work habits are available in *SYSTH* (6.10, 6.11).

**Paper-and-Pencil Tasks****Part A**

Have students predict the spontaneous and/or non-spontaneous reactions between metal and ionic species using Appendix 6.2: Table of Standard Reduction Potentials.

1. A zinc metal strip is placed into a 1.0 mol/L solution of copper(II) nitrate.

*Answer:*

The species available for reacting are:  $\text{Zn}^0_{(\text{aq})}$ ,  $\text{Cu}^{2+}_{(\text{aq})}$ , and  $\text{NO}_3^-_{(\text{aq})}$

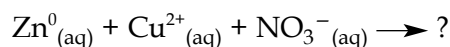

$\text{NO}_3^-_{(\text{aq})}$  ions will not react unless the solution is acidic. See the table in Appendix 6.2.

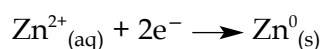
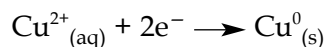

According to the table,  $\text{Cu}^{2+}$  has a greater affinity for electrons than  $\text{Zn}^{2+}$ , and so  $\text{Cu}^{2+}$  will attract electrons to become reduced in the process to  $\text{Cu}^0$ . This causes  $\text{Zn}^0$  to give up electrons and become oxidized to  $\text{Zn}^{2+}$ .

**Topic 6:**  
**Electrochemistry**
**SPECIFIC LEARNING OUTCOMES**
**C12-6-01:** Develop an activity series experimentally.

**C12-6-02:** Predict the spontaneity of reactions using an activity series.

(continued)

The two reactions are

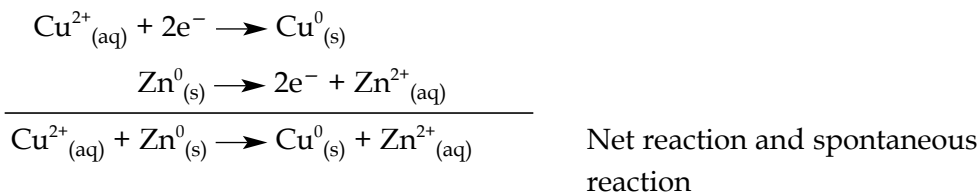

2. An aluminum strip of metal is placed into a 1.0 mol/L solution of silver nitrate.

*Answer:*

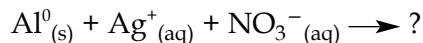
 The species available for reacting are:  $\text{Al}^0_{(\text{s})}$ ,  $\text{Ag}^+_{(\text{aq})}$ , and  $\text{NO}_3^-_{(\text{aq})}$ 

$\text{NO}_3^-_{(\text{aq})}$  ions will not react unless the solution is acidic. See the table in Appendix 6.2.

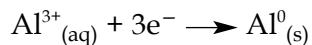
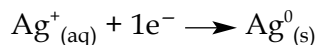

According to the table,  $\text{Ag}^+$  has a greater affinity for electrons than  $\text{Al}^{3+}$ , and so  $\text{Ag}^+$  will attract electrons to become reduced in the process to  $\text{Ag}^0$ . This causes  $\text{Al}^0$  to give up electrons and become oxidized to  $\text{Al}^{3+}$ .

The two reactions are

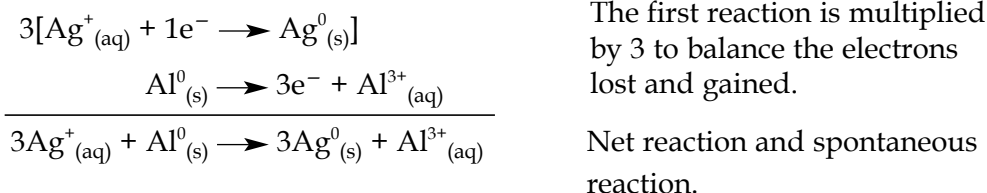



**SKILLS AND ATTITUDES OUTCOMES**

**C12-0-S1:** Demonstrate work habits that ensure personal safety and the safety of others, as well as consideration for the environment.

Include: knowledge and use of relevant safety precautions, Workplace Hazardous Materials Information System (WHMIS), and emergency equipment

**C12-0-S5:** Collect, record, organize, and display data using an appropriate format.

Examples: labelled diagrams, graphs, multimedia applications, software integration, probeware . . .

**Part B**

Have students use a Standard Reduction Potentials table to answer the following questions about these species:  $\text{Au}^{3+}$ ,  $\text{Cr}^0_{(s)}$ ,  $\text{Sr}^{2+}$ , and  $\text{Br}^-$ .

*Answers:*

- |   |                                 |
|---|---------------------------------|
| 1. Which species is the most easily reduced (i.e., is the strongest oxidizing agent)? | $\text{Au}^{3+}$                |
| 2. Which species has the greatest affinity for electrons?                             | $\text{Au}^{3+}$                |
| 3. Which species is the least easily oxidized?  | $\text{Br}^-$                   |
| 4. Which species is the most easily oxidized?   | $\text{Cr}^0$                   |
| 5. Which species will oxidize $\text{Sn}^{2+}$ to $\text{Sn}^{4+}$ ?                  | $\text{Au}^{3+}$                |
| 6. Which species will reduce $\text{F}_{2(g)}$ to $2\text{F}^-_{(aq)}$ ?              | $\text{Br}^-$ and $\text{Cr}^0$ |

**Part C**

Inform students that in an investigation (similar to the one done in class), strips of gold, silver, and tin were placed in beakers containing their ions, resulting in the following reactions:

- $\text{Sn}^0_{(s)} + \text{Ag}^+_{(aq)} \longrightarrow$  metallic Ag deposited
- $\text{Au}^{3+}_{(aq)} + \text{Sn}^0_{(s)} \longrightarrow$  metallic Au deposited
- $\text{Au}^0_{(s)} + \text{Ag}^+_{(aq)} \longrightarrow$  no reaction

Have students arrange the ions used in the investigation in order of decreasing tendency to attract electrons (i.e., the species with the greatest affinity for electrons would be at the top).

*Answers:*

- Reaction 1 tells us that for the reaction to proceed as written,  $\text{Ag}^+$  must have a greater affinity for electrons than  $\text{Sn}^{2+}$ ; therefore,  $\text{Ag}^+$  must be above  $\text{Sn}^{2+}$  on a Standard Reduction Potentials table that has the species with the greatest affinity for electrons at the top.

## Topic 6: Electrochemistry

### SPECIFIC LEARNING OUTCOMES

C12-6-01: Develop an activity series experimentally.

C12-6-02: Predict the spontaneity of reactions using an activity series.

(continued)

- Similarly, reaction 2 tells us that for the reaction to proceed as written,  $\text{Au}^{3+}$  has a greater affinity for electrons than  $\text{Sn}^{2+}$ ; therefore,  $\text{Au}^{3+}$  must be above  $\text{Sn}^{2+}$  on a table that has the species with the greatest affinity for electrons at the top.  
**Note:** The reverse logic in this explanation is of interest.
- If reaction 3 had produced products, then, using the same logic as in the previous two reactions,  $\text{Ag}^+$  would have been above  $\text{Au}^{3+}$ . However, the reaction did not occur, and so the reverse is true, or  $\text{Au}^{3+}$  is above  $\text{Ag}^+$ .
- The complete list of reactions or species having the greatest affinity for electrons would be as follows:



or

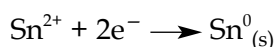
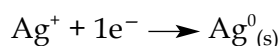
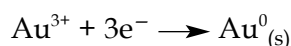

### Part D

Challenge students with the following question:

Substances A, B, C, D, and E are metals that form positive ions. Ions of metal A react with metal E but not with metal C. However, metal C does react with solutions containing ions of metals D and B. Metal D will not react with ions of metal B. List the metal ions, placing the best oxidizing agent at the top.

*Answers:*

As students are becoming more familiar with the logic used to arrange the various species, a shorter explanation will now be used. Assume the easiest case, where the metal ions are  $1^+$ .



The species order, according to the best oxidizer first, would be:  $\text{D}^+$ ,  $\text{B}^+$ ,  $\text{C}^+$ ,  $\text{A}^+$ ,  $\text{E}^+$ .

**SKILLS AND ATTITUDES OUTCOMES**

**C12-0-S1:** Demonstrate work habits that ensure personal safety and the safety of others, as well as consideration for the environment.

Include: knowledge and use of relevant safety precautions, Workplace Hazardous Materials Information System (WHMIS), and emergency equipment

**C12-0-S5:** Collect, record, organize, and display data using an appropriate format.

Examples: labelled diagrams, graphs, multimedia applications, software integration, probeware . . .

**LEARNING RESOURCES LINKS**

*Chemistry in Microscale*, Book 1 (Ehrenkranz and Mauch)

Metal Reactivities, 80

*Glencoe Chemistry: Matter and Change* (Dingrando, et al. 288)

*Prentice Hall Chemistry* (Wilbraham, et al.)

Table 21.1: Activity Series of Metals, with Half-Reactions for Oxidation Process, 664 (stresses the reduction process)

**Investigations**

*Nelson Chemistry 12: College Preparation*, Ontario Edition (Davies, et al.)

Activity 5.3: Developing an Activity Series of Metals, 385

*Prentice Hall Chemistry: Laboratory Manual* (Wilbraham, Staley, and Matta)

Experiment 46: Oxidation-Reduction Reactions, 275

*Prentice Hall Chemistry: Small-Scale Chemistry Laboratory Manual* (Waterman and Thompson)

Experiment 34: Determination of an Activity Series, 241

**Websites**

Chemical Education Research Group, Iowa State University. "Chemistry Experiment Simulations and Conceptual Computer Animations." *Chemical Education*. <<http://group.chem.iastate.edu/Greenbowe/sections/projectfolder/simDownload/index4.html>> (22 Nov. 2012).

Simulation: Reactions of Metals and Metal Ions Experiment

Virtual Crezlab Qualitative Analysis. "Displacement Reaction." *Teaching Laboratory*. Crescent Girls' School.

<[www.crescent.edu.sg/crezlab/webpages/pptReaction3.htm](http://www.crescent.edu.sg/crezlab/webpages/pptReaction3.htm)> (3 Apr. 2012).

**Appendices**

Appendix 6.1: Activity Series: Lab Activity

Appendix 6.2: Table of Standard Reduction Potentials

**Selecting Learning Resources**

For additional information on selecting learning resources for Grade 11 and Grade 12 Chemistry, see the Manitoba Education website at <[www.edu.gov.mb.ca/k12/learnres/bibliographies.html](http://www.edu.gov.mb.ca/k12/learnres/bibliographies.html)>.

## Topic 6: Electrochemistry

### SPECIFIC LEARNING OUTCOME

**C12-6-03:** Outline the historical development of voltaic (galvanic) cells.  
Include: contributions of Luigi Galvani and Alessandro Volta

(1 hour)

SLO: C12-6-03

### SUGGESTIONS FOR INSTRUCTION

#### TEACHER NOTES

#### Historical Development of Voltaic (Galvanic) Cells

*Electrochemical cells* are also referred to as *voltaic cells* or *voltaic piles*, named after their inventor Alessandro Volta. Another term for electrochemical cells is *galvanic cells*, in honour of Luigi Galvani, who influenced Volta's invention.

Luigi Galvani (1737–1798), Italian physician and physicist, discovered a link between electricity and animal tissue in the 1770s. While his primary interests were comparative anatomy and medicine, he also studied electricity. He observed that a steel scalpel that had been near his electrostatic generators would cause the legs of preserved frogs to twitch if the blade touched a nerve. He also observed twitches when brass hooks were holding the frog specimens as he dissected the frogs with his scalpel. He concluded that an electrical fluid, which he called “animal electricity,” was being sent along the frog nerves.

Alessandro Volta (1745–1827), an Italian physicist and contemporary of Galvani, was doing pioneer work in electricity. When Galvani's “animal electricity” findings were published, Volta was skeptical and began designing experiments to explain Galvani's observations. Volta soon discovered that having two different metals in contact with each other in a moist environment would generate electricity. He concluded that the frog tissues were just indicators that there was a current

#### General Learning Outcome Connections

- GLO A1:** Recognize both the power and limitations of science as a way of answering questions about the world and explaining natural phenomena.
- GLO A2:** Recognize that scientific knowledge is based on evidence, models, and explanations, and evolves as new evidence appears and new conceptualizations develop.
- GLO A4:** Identify and appreciate contributions made by women and men from many societies and cultural backgrounds that have increased our understanding of the world and brought about technological innovations.
- GLO C2:** Demonstrate appropriate scientific inquiry skills when seeking answers to questions.
- GLO C4:** Demonstrate appropriate critical thinking and decision-making skills when choosing a course of action based on scientific and technological information.
- GLO C5:** Demonstrate curiosity, skepticism, creativity, open-mindedness, accuracy, precision, honesty, and persistence, and appreciate their importance as scientific and technological habits of mind.
- GLO C6:** Employ effective communication skills and use information technology to gather and share scientific and technological ideas and data.
- GLO C8:** Evaluate, from a scientific perspective, information and ideas encountered during investigations and in daily life.

**SKILLS AND ATTITUDES OUTCOMES**

- C12-0-R1:** Synthesize information obtained from a variety of sources.  
Include: print and electronic sources, specialists, and other resource people
- C12-0-R2:** Evaluate information obtained to determine its usefulness for information needs.  
*Examples: scientific accuracy, reliability, currency, relevance, balance of perspectives, bias . . .*
- C12-0-R3:** Quote from or refer to sources as required and reference information sources according to an accepted practice.
- C12-0-N1:** Explain the roles of theory, evidence, and models in the development of scientific knowledge.
- C12-0-N2:** Describe, from a historical perspective, how the observations and experimental work of many individuals led to modern understandings of matter.
- C12-0-N3:** Describe how scientific knowledge changes as new evidence emerges and/or new ideas and interpretations are advanced.

between the metals. This became known as *metallic electricity*. Volta maintained that the only source of electricity was through two dissimilar metals. He studied different combinations of metals and conditions and, in 1800, built the first *electrochemical cell*, which consisted of three plates or discs: zinc and copper sandwiching pasteboard that had been soaked in salt water or vinegar. By stacking several of these three-disc cells (called *voltaic piles*), he created a reliable, constant current of electricity that revolutionized electrical research and started the study of electrochemistry.

The debate over whether animal or metallic electricity was the correct explanation went on in the scientific community for many years. We now know that both Galvani and Volta were right and wrong about the frog legs: electric potential in nerves does stimulate muscle tissue, but this is not a special biological electricity.

**Research and Reports**

Have students research the historical development of the voltaic (galvanic) cell, using various print and online resources, and report their findings either individually or in small groups.

*Sample Websites:*

Carboni, Giorgio. *Experiments in Electrochemistry*. 1998. *Fun Science Gallery*.  
<[www.funsci.com/fun3\\_en/electro/electro.htm](http://www.funsci.com/fun3_en/electro/electro.htm)> (5 Apr. 2012).

This website presents an explanation of various electrochemical cells.

Corrosion Doctor. *Who's Who in Electrochemistry*.

<[www.corrosion-doctors.org/Who's\\_who.htm](http://www.corrosion-doctors.org/Who's_who.htm)> (5 Apr. 2012).

This website features biographies of famous scientists, including Luigi Galvani and Alessandro Volta.

Energy Quest. *Super Scientists: A Gallery of Energy Pioneers*. 2006.

<[www.energyquest.ca.gov/scientists/](http://www.energyquest.ca.gov/scientists/)> (5 Apr. 2012).

This website provides information about Luigi Galvani and Alessandro Volta.

**Topic 6:  
Electrochemistry****SPECIFIC LEARNING OUTCOME**

**C12-6-03:** Outline the historical development of voltaic (galvanic) cells.  
Include: contributions of Luigi Galvani and Alessandro Volta

(continued)

Greenslade, Thomas B. "The Electrochemical Cell." *Instruments for Natural Philosophy*. <[http://physics.kenyon.edu/EarlyApparatus/Electricity/Electrochemical\\_Cell/Electrochemical\\_Cell.html](http://physics.kenyon.edu/EarlyApparatus/Electricity/Electrochemical_Cell/Electrochemical_Cell.html)> (5 Apr. 2012).

This website presents historical information about the electrochemical cell, along with images of some of the original voltaic cells.

Magnetic Lab: National High Magnetic Field Laboratory. "Voltaic Pile." *Education*. 1995–2012. <[www.magnet.fsu.edu/education/tutorials/java/voltaicpile1/index.html](http://www.magnet.fsu.edu/education/tutorials/java/voltaicpile1/index.html)> (22 Aug. 2012).

At this website, students can learn about Alessandro Volta's application of the principles of electrochemistry to the creation of the first battery, a tool that came to be known as the voltaic pile.

Süss-Fink, Georg, and Frédéric Chérioux. "6.2: Scheme of Electrochemical Cell." *Unit 5: Electron Transfer Reactions*. 2005. *General Chemistry*. <<http://chimge.unil.ch/En/redox/1red13.htm>> (10 Apr. 2012).

This website includes a diagram that shows the various parts of an electrochemical cell.

**Laboratory Activity/Demonstration**

1. Have students construct a voltaic cell by building a lemon battery. This involves inserting two metals, such as zinc and copper, into a lemon and connecting the metals with wire to produce electricity (see Dingrando, et al. 663).
2. Students can also replicate Volta's experiment and make a voltaic pile. Have them alternate nickels and pennies (copper discs) and pieces of cardboard (soaked in salt water) and connect a lead from the bottom to the top of the pile. They can then demonstrate how an electric current is generated by placing a zinc disc on the bottom of the pile, with electrolyte-soaked filter paper in the middle and a copper disc on top (this "sandwich" is called an *element*). After building a stack of the six elements, and being careful that the solution does not drip down the side of the stack (this can cause a short circuit), two cables with alligator clips—one at the bottom and one at the top—can be used to measure the voltage between the bottom zinc disc and the top copper disc. The voltaic pile can power a small LCD clock, a thermometer, or a calculator.

**SKILLS AND ATTITUDES OUTCOMES**

**C12-0-R1:** Synthesize information obtained from a variety of sources.

Include: print and electronic sources, specialists, and other resource people

**C12-0-R2:** Evaluate information obtained to determine its usefulness for information needs.

*Examples: scientific accuracy, reliability, currency, relevance, balance of perspectives, bias . . .*

**C12-0-R3:** Quote from or refer to sources as required and reference information sources according to an accepted practice.

**C12-0-N1:** Explain the roles of theory, evidence, and models in the development of scientific knowledge.

**C12-0-N2:** Describe, from a historical perspective, how the observations and experimental work of many individuals led to modern understandings of matter.

**C12-0-N3:** Describe how scientific knowledge changes as new evidence emerges and/or new ideas and interpretations are advanced.

---

**SUGGESTIONS FOR ASSESSMENT**

---

**Paper-and-Pencil Task**

Ask students to describe how electrochemistry is involved in producing energy in batteries (see Fisher 294).

**Laboratory Skills**

If students were asked to recreate Volta's experiment as either a demonstration or a lab activity, lab skills could be assessed using rubrics and checklists. Sample checklists for assessing lab skills and work habits are available in *SYSTH* (6.10, 6.11).

**Class Discussion**

Have the class brainstorm a list of items that require some type of battery.

**Research Presentations**

Have students present their research findings on the historical development of voltaic cells. Use a presentation rubric to assess students' presentations (e.g., see Rubric for Assessment of Student Presentation in Appendix 11).

**Journal Writing**

1. Have students answer the following questions:

What would be the effect of not having any kind of electrochemical cell?  
How would our lives change?

2. After completing their research, students could describe the research done by any of the scientists responsible for the development of electrochemical cells.

**Visual Displays**

Students can diagram and illustrate Volta's voltaic pile, explaining why it produces an electric current. These visual displays could be assessed using the Rubric for Assessment of Student Presentation and the Rubric for Assessment of Class Presentation (see Appendix 11).

---

**Topic 6:  
Electrochemistry**

**SPECIFIC LEARNING OUTCOME**

**C12-6-03:** Outline the historical development of voltaic (galvanic) cells.  
Include: contributions of Luigi Galvani and Alessandro Volta

(continued)

**LEARNING RESOURCES LINKS**



*Glencoe Chemistry: Matter and Change, Science Notebook* (Fisher 294)

*Prentice Hall Chemistry* (Wilbraham, et al.)

Section 21.1: Electrochemical Cells, 663–668 (shows Volta’s electric piles)

**Investigation**

*Glencoe Chemistry: Matter and Change* (Dingrando, et al.)

Discovery Lab: A Lemon Battery? 663

**Websites**

Carboni, Giorgio. *Experiments in Electrochemistry*. 1998. *Fun Science Gallery*.  
<[www.funsci.com/fun3\\_en/electro/electro.htm](http://www.funsci.com/fun3_en/electro/electro.htm)> (5 Apr. 2012).

Corrosion Doctor. *Who’s Who in Electrochemistry*. <[www.corrosion-doctors.org/Who’s\\_who.htm](http://www.corrosion-doctors.org/Who's_who.htm)> (5 Apr. 2012).

Energy Quest. *Super Scientists: A Gallery of Energy Pioneers*. 2006.  
<[www.energyquest.ca.gov/scientists/](http://www.energyquest.ca.gov/scientists/)> (5 Apr. 2012).

Greenslade, Thomas B. “The Electrochemical Cell.” *Instruments for Natural Philosophy*. <[http://physics.kenyon.edu/EarlyApparatus/Electricity/Electrochemical\\_Cell/Electrochemical\\_Cell.html](http://physics.kenyon.edu/EarlyApparatus/Electricity/Electrochemical_Cell/Electrochemical_Cell.html)> (5 Apr. 2012).

Magnetic Lab: National High Magnetic Field Laboratory. “Voltaic Pile.” *Education*. 1995–2012. <[www.magnet.fsu.edu/education/tutorials/java/voltaicpile1/index.html](http://www.magnet.fsu.edu/education/tutorials/java/voltaicpile1/index.html)> (22 Aug. 2012).

Süss-Fink, Georg, and Frédéric Chérioux. “6.2: Scheme of Electrochemical Cell.” *Unit 5: Electron Transfer Reactions*. 2005. *General Chemistry*.  
<<http://chimge.unil.ch/En/redox/1red13.htm>> (10 Apr. 2012).

**Selecting Learning Resources**

For additional information on selecting learning resources for Grade 11 and Grade 12 Chemistry, see the Manitoba Education website at <[www.edu.gov.mb.ca/k12/learnres/bibliographies.html](http://www.edu.gov.mb.ca/k12/learnres/bibliographies.html)>.



**SKILLS AND ATTITUDES OUTCOMES**

**C12-0-R1:** Synthesize information obtained from a variety of sources.

Include: print and electronic sources, specialists, and other resource people

**C12-0-R2:** Evaluate information obtained to determine its usefulness for information needs.

*Examples: scientific accuracy, reliability, currency, relevance, balance of perspectives, bias . . .*

**C12-0-R3:** Quote from or refer to sources as required and reference information sources according to an accepted practice.

**C12-0-N1:** Explain the roles of theory, evidence, and models in the development of scientific knowledge.

**C12-0-N2:** Describe, from a historical perspective, how the observations and experimental work of many individuals led to modern understandings of matter.

**C12-0-N3:** Describe how scientific knowledge changes as new evidence emerges and/or new ideas and interpretations are advanced.

---

**NOTES**

## Topic 6: Electrochemistry

### SPECIFIC LEARNING OUTCOMES

**C12-6-04:** Explain the operation of a voltaic (galvanic) cell at the visual, particulate, and symbolic levels.

Include: writing half-cell reactions, the overall reaction, and shorthand (line) notation

**C12-6-05:** Construct a functioning voltaic (galvanic) cell and measure its potential.

(3 hours)

SLO: C12-6-04  
SLO: C12-6-05

### SUGGESTIONS FOR INSTRUCTION

#### Entry-Level Knowledge

In Grade 9 Science (Cluster 3: The Nature of Electricity), students completed a detailed study of electricity. They related the particle model of electricity to atomic structure (S1-3-04), constructed diagrams for electrical circuits (S1-3-13), and used appropriate instruments to measure voltage (S1-3-14). As a result, students will have prior knowledge concerning electrical circuits; however, a review should be done.

#### Demonstration/Discrepant Event

To start the class with a demonstration, walk into the classroom while drinking orange juice. After taking a sip, pour the remaining juice into a beaker in which there are two electrodes: one of magnesium metal and the other of copper. Ensure that both electrodes are connected to a large display clock. As the clock starts running, state that “we are now on the clock and we can begin the class.”

An alternative demonstration might be to have a piece of copper and a piece of clean zinc metal stuck into a lemon connected to either a voltmeter or a similar clock. This demonstration may be viewed online.

*Sample Website:*

Carboni, Giorgio. “The Lemon Battery.” *Experiments in Electrochemistry*. 1998. *Fun Science Gallery*. <[www.funsci.com/fun3\\_en/electro/electro.htm#2](http://www.funsci.com/fun3_en/electro/electro.htm#2)> (10 Apr. 2012).

This website outlines the procedure for performing “The Lemon Battery” demonstration.

#### General Learning Outcome Connections

- GLO C1:** Recognize safety symbols and practices related to scientific and technological activities and to their daily lives, and apply this knowledge in appropriate situations.
- GLO C2:** Demonstrate appropriate scientific inquiry skills when seeking answers to questions.
- GLO C5:** Demonstrate curiosity, skepticism, creativity, open-mindedness, accuracy, precision, honesty, and persistence, and appreciate their importance as scientific and technological habits of mind.
- GLO D3:** Understand the properties and structures of matter, as well as various common manifestations and applications of the actions and interactions of matter.

**SKILLS AND ATTITUDES OUTCOMES**

**C12-0-U1:** Use appropriate strategies and skills to develop an understanding of chemical concepts.

*Examples: analogies, concept frames, concept maps, manipulatives, particulate representations, role-plays, simulations, sort-and-predict frames, word cycles . . .*

**C12-0-S4:** Select and use scientific equipment appropriately and safely.

*Examples: volumetric glassware, balance, thermometer . . .*

**C12-0-S5:** Collect, record, organize, and display data using an appropriate format.

*Examples: labelled diagrams, graphs, multimedia applications, software integration, probeware . . .*

**C12-0-A1:** Demonstrate confidence in their ability to carry out investigations in chemistry and to address STSE-related issues.

---

**TEACHER NOTES****The Operation of a Voltaic Cell**

Students should be asked to explain the operation of electrochemical cells using the three modes of representation: visual (macroscopic), particulate (microscopic), and symbolic. Chemistry texts provide clear particulate diagrams of electrochemical cell processes.

After addressing specific learning outcomes C12-6-04 and C12-6-05, students should understand that a chemical reaction can be used to create an electric current. A *voltaic cell* is an apparatus that uses a spontaneous redox reaction to produce electrical energy. According to the law of conservation of energy, energy cannot be created or destroyed; it is simply converted from one form of energy into another. In a voltaic cell, the chemical energy from a spontaneous redox reaction is converted into electrical energy.

Many chemical and electrical processes occur in an electrochemical cell. Students must be able to explain the reactions in both half-cells in terms of electron flow, anion flow, and cation flow.

**Constructing a Voltaic Cell**

Students should first construct a spontaneous, working voltaic cell based on their understanding of the electromotive series discussed in relation to learning outcomes C12-6-01 and C12-6-02. Students should have access to voltmeters, wire, alligator clamps, U-tubes, cotton wool, a number of common metals together with 1.0 mol/L solutions of their ions, and a 1.0 mol/L solution of sodium, potassium, or ammonium nitrate to use in their salt bridge.

Have students write out the spontaneous reaction and identify the reduction reaction, the oxidation reaction, and the two half-cell reactions, using Appendix 6.2: Table of Standard Reduction Potentials. After confirming spontaneity, have each group of students construct their cell and measure the voltage across the electrodes.

## Topic 6: Electrochemistry

### SPECIFIC LEARNING OUTCOMES

**C12-6-04:** Explain the operation of a voltaic (galvanic) cell at the visual, particulate, and symbolic levels.

Include: writing half-cell reactions, the overall reaction, and shorthand (line) notation

**C12-6-05:** Construct a functioning voltaic (galvanic) cell and measure its potential.

(continued)

Note that students will likely not achieve the predicted net cell potential ( $E^0_{\text{cell}}$ ) voltage. According to the Nernst equation, the maximum voltage is dependent on concentration and assumes that temperature is constant. Immediately after the connections are made, concentrations will change. The reactant ions will decrease as they are used up, and the product ions will increase as they are produced. Le Châtelier's principle will then cause a stress on the system and attempt to re-establish equilibrium by the reverse reaction and by reducing the net cell voltage. At this point, ask students what conditions would cause the equilibrium to shift forward and increase voltage.

A concentration gradient would occur at each electrode, causing both an excess of one ion and a shortage of other ions for the net reaction.

### The Daniell Cell

The diagram below illustrates the electrochemical cell for the following net reaction:

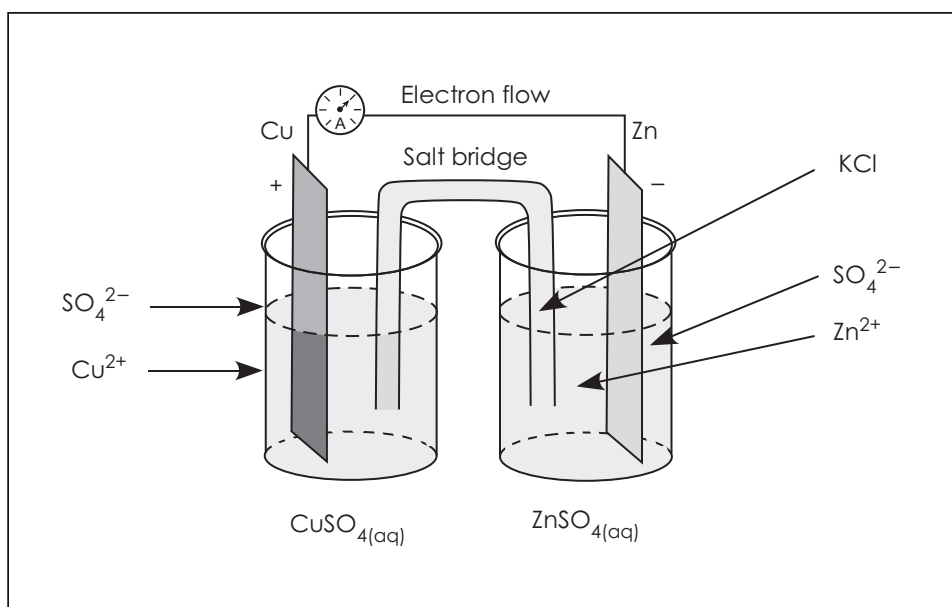
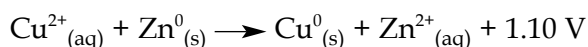

## SKILLS AND ATTITUDES OUTCOMES

**C12-0-U1:** Use appropriate strategies and skills to develop an understanding of chemical concepts.

*Examples: analogies, concept frames, concept maps, manipulatives, particulate representations, role-plays, simulations, sort-and-predict frames, word cycles . . .*

**C12-0-S4:** Select and use scientific equipment appropriately and safely.

*Examples: volumetric glassware, balance, thermometer . . .*

**C12-0-S5:** Collect, record, organize, and display data using an appropriate format.

*Examples: labelled diagrams, graphs, multimedia applications, software integration, probeware . . .*

**C12-0-A1:** Demonstrate confidence in their ability to carry out investigations in chemistry and to address STSE-related issues.

The illustrated cell is a special case of an electrochemical cell. It was first successfully constructed in 1836 by British chemist John Frederic Daniell (1790–1845). (An Internet search will generate extensive information, if required.) This particular electrochemical cell with copper and zinc electrodes is now called a Daniell cell.

In the diagram, the two half-cell reactions are connected by a salt bridge containing a soluble ionic salt such as potassium chloride (KCl). The salt bridge is used as an internal circuit and allows the half-cells to remain electrically balanced. In the case of this cell, as zinc ions are produced at the anode, making the anodic compartment positive with an excess of positive ions, the chloride ions move from the salt bridge toward the anode to maintain electrical neutrality within that half-cell. In the case of the cathodic copper cell, copper ions are being removed from the solution, making it electrically negative. To counteract this, positive potassium ions from the salt bridge move toward the cathode, again to maintain electrical neutrality within the cathodic cell. When the two half-cells are joined with a wire path for the electrons and another path for the positive and negative ion movement, an electrochemical cell is made.

Each galvanic cell should consist of

- an anode (zinc), which oxidizes (loses  $e^-$ )
- a cathode (copper), which reduces (gains  $e^-$ )

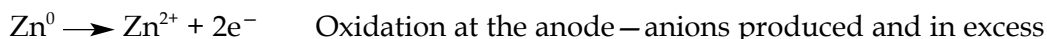
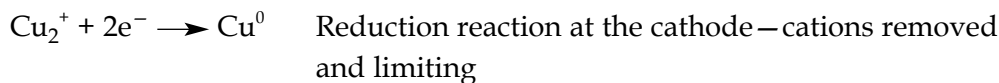

Electrons flow from the anode to the cathode of an electrochemical cell.

Anions move toward the anode, and cations move toward the cathode.

The migration of ions is essential to the operation of the cell, since the accumulation of ionic charge in the solution around the electrodes would oppose the movement of electrons. The result is a voltage of +1.10 V.

The same cell can be constructed with a porous cup acting as the salt bridge. Give students the opportunity to construct cells using either a salt bridge or a porous cup.

## Topic 6: Electrochemistry

### SPECIFIC LEARNING OUTCOMES

**C12-6-04:** Explain the operation of a voltaic (galvanic) cell at the visual, particulate, and symbolic levels.

Include: writing half-cell reactions, the overall reaction, and shorthand (line) notation

**C12-6-05:** Construct a functioning voltaic (galvanic) cell and measure its potential.

(continued)

A shorthand (line) notation is often used to represent the voltaic cell diagram.

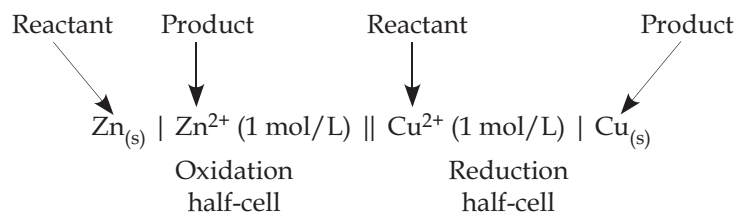

- The single vertical line (|) represents a phase boundary between the metal and the ion in solution.
- The double vertical line (||) represents the salt bridge. By convention, the anode is written first, to the left of the double lines, and the cathode reaction is written second, to the right of the double lines.

### Animations/Simulations

Animations help students appreciate particulate (microscopic) events and subsequent symbolic representations. Have students perform simulations or view animations online.

*Sample Websites:*

Chemical Education Research Group, Iowa State University. "Chemistry Experiment Simulations and Conceptual Computer Animations." *Chemical Education*. <<http://group.chem.iastate.edu/Greenbowe/sections/projectfolder/simDownload/index4.html>> (22 Nov. 2012).

In the Electrochemistry section, download and unzip the following simulation:

- Electrochemical Cell Experiment

This simulation helps students create a voltaic cell. Students select the electrodes and the ionic solutions needed to create a functioning electrochemical cell.

The North Carolina School of Science and Mathematics (NCSSM). Distance Education and Extended Programs. "Chemistry – Electrochemistry." *Teacher's Instructional Graphics and Educational Resource (TIGER)*.

<[www.dlt.ncssm.edu/tiger/chem6.htm#electro](http://www.dlt.ncssm.edu/tiger/chem6.htm#electro)> (11 Apr. 2012).

This website contains a set of six narrated Flash animations explaining how a voltaic cell works.

**SKILLS AND ATTITUDES OUTCOMES**

**C12-0-U1:** Use appropriate strategies and skills to develop an understanding of chemical concepts.

*Examples: analogies, concept frames, concept maps, manipulatives, particulate representations, role-plays, simulations, sort-and-predict frames, word cycles . . .*

**C12-0-S4:** Select and use scientific equipment appropriately and safely.

*Examples: volumetric glassware, balance, thermometer . . .*

**C12-0-S5:** Collect, record, organize, and display data using an appropriate format.

*Examples: labelled diagrams, graphs, multimedia applications, software integration, probeware . . .*

**C12-0-A1:** Demonstrate confidence in their ability to carry out investigations in chemistry and to address STSE-related issues.

---

**SUGGESTIONS FOR ASSESSMENT****Paper-and-Pencil Tasks**

Have students draw a diagram of a voltaic cell on which they identify the positive and negative electrodes, anode, cathode, half-cell reactions, direction of electron flow, direction of ion flow, the solutions used, which electrode erodes, which electrode plates, the net cell reaction, and the voltage produced. They should focus on the particulate nature of matter when explaining electrode reactions, the movement of ions, and electrons through the circuit, and the maintenance of electrical neutrality in all parts of the cell.

**Laboratory Skills**

Students should be able to build and test simple voltaic cells. Assess students' lab skills as necessary. Sample checklists for assessing students' lab skills and work habits are available in *SYSTH* (6.10, 6.11). Have groups of students compare the results of their voltaic cells and explain differences in voltage. Try to have several groups use the same electrodes to allow for comparison of results.

**Research and Reports**

Have students research the electrochemical cell, using online resources, and report their findings.

*Sample Websites:*

Carboni, Giorgio. *Experiments in Electrochemistry*. 1998. *Fun Science Gallery*. <[www.funsci.com/fun3\\_en/electro/electro.htm](http://www.funsci.com/fun3_en/electro/electro.htm)> (5 Apr. 2012).

This website presents an explanation of various electrochemical cells.

Greenslade, Thomas B. "The Electrochemical Cell." *Instruments for Natural Philosophy*. <[http://physics.kenyon.edu/EarlyApparatus/Electricity/Electrochemical\\_Cell/Electrochemical\\_Cell.html](http://physics.kenyon.edu/EarlyApparatus/Electricity/Electrochemical_Cell/Electrochemical_Cell.html)> (5 Apr. 2012).

This website presents historical information about the electrochemical cell, along with images of some of the original voltaic cells.

## Topic 6: Electrochemistry

### SPECIFIC LEARNING OUTCOMES

**C12-6-04:** Explain the operation of a voltaic (galvanic) cell at the visual, particulate, and symbolic levels.

Include: writing half-cell reactions, the overall reaction, and shorthand (line) notation

**C12-6-05:** Construct a functioning voltaic (galvanic) cell and measure its potential.

(continued)

Süss-Fink, Georg, and Frédéric Chérioux. "6.2: Scheme of Electrochemical Cell." *Unit 5: Electron Transfer Reactions*. 2005. *General Chemistry*. <<http://chimge.unil.ch/En/redox/1red13.htm>> (10 Apr. 2012).

This website includes a diagram that shows the various parts of an electrochemical cell.

### Journal Writing

After students have read and viewed online information about the electrochemical cell, they can describe the research done by any of the scientists responsible for the development of electrochemical cells.

### LEARNING RESOURCES LINKS



*Glencoe Chemistry: Matter and Change* (Dingrando, et al.)  
Section 21.1: Voltaic Cells, 663

*Prentice Hall Chemistry* (Wilbraham, et al.)  
Voltaic Cells, 665

#### Investigation

*Prentice Hall Chemistry: Small-Scale Chemistry Laboratory Manual* (Waterman and Thompson)  
Experiment 36: Small-Scale Voltaic Cells, 257

#### Websites

Carboni, Giorgio. *Experiments in Electrochemistry*. 1998. *Fun Science Gallery*. <[www.funsci.com/fun3\\_en/electro/electro.htm](http://www.funsci.com/fun3_en/electro/electro.htm)> (5 Apr. 2012).

\_\_\_\_\_. "The Lemon Battery." *Experiments in Electrochemistry*. 1998. *Fun Science Gallery*. <[www.funsci.com/fun3\\_en/electro/electro.htm#2](http://www.funsci.com/fun3_en/electro/electro.htm#2)> (10 Apr. 2012).

Chemical Education Research Group, Iowa State University. "Chemistry Experiment Simulations and Conceptual Computer Animations." *Chemical Education*. <<http://group.chem.iastate.edu/Greenbowe/sections/projectfolder/simDownload/index4.html>> (22 Nov. 2012).

Simulation: Electrochemical Cell Experiment

Greenslade, Thomas B. "The Electrochemical Cell." *Instruments for Natural Philosophy*. <[http://physics.kenyon.edu/EarlyApparatus/Electricity/Electrochemical\\_Cell/Electrochemical\\_Cell.html](http://physics.kenyon.edu/EarlyApparatus/Electricity/Electrochemical_Cell/Electrochemical_Cell.html)> (5 Apr. 2012).



**SKILLS AND ATTITUDES OUTCOMES**

**C12-0-U1:** Use appropriate strategies and skills to develop an understanding of chemical concepts.

*Examples: analogies, concept frames, concept maps, manipulatives, particulate representations, role-plays, simulations, sort-and-predict frames, word cycles . . .*

**C12-0-S4:** Select and use scientific equipment appropriately and safely.

*Examples: volumetric glassware, balance, thermometer . . .*

**C12-0-S5:** Collect, record, organize, and display data using an appropriate format.

*Examples: labelled diagrams, graphs, multimedia applications, software integration, probeware . . .*

**C12-0-A1:** Demonstrate confidence in their ability to carry out investigations in chemistry and to address STSE-related issues.

---

The North Carolina School of Science and Mathematics (NCSSM). Distance Education and Extended Programs. "Chemistry – Electrochemistry." *Teacher's Instructional Graphics and Educational Resource (TIGER)*. <[www.dlt.ncssm.edu/tiger/chem6.htm#electro](http://www.dlt.ncssm.edu/tiger/chem6.htm#electro)> (11 Apr. 2012).

Süss-Fink, Georg, and Frédéric Chérioux. "6.2: Scheme of Electrochemical Cell." *Unit 5: Electron Transfer Reactions*. 2005. *General Chemistry*. <<http://chimge.unil.ch/En/redox/1red13.htm>> (10 Apr. 2012).

**Appendix**

Appendix 6.2: Table of Standard Reduction Potentials

**Selecting Learning Resources**

For additional information on selecting learning resources for Grade 11 and Grade 12 Chemistry, see the Manitoba Education website at <[www.edu.gov.mb.ca/k12/learnres/bibliographies.html](http://www.edu.gov.mb.ca/k12/learnres/bibliographies.html)>.

## Topic 6: Electrochemistry

### SPECIFIC LEARNING OUTCOMES

**C12-6-06:** Define *standard electrode potential*.

Include: hydrogen electrode as a reference

**C12-6-07:** Calculate standard cell potentials, given standard electrode potentials.

**C12-6-08:** Predict the spontaneity of reactions using standard electrode potentials.

(2.5 hours)

SLO: C12-6-06  
SLO: C12-6-07  
SLO: C12-6-08

### SUGGESTIONS FOR INSTRUCTION

#### Entry-Level Knowledge

Students focused on electricity in great depth in Grade 9 Science, and they have studied electron transfer extensively in Grade 12 Chemistry. However, each time students add a new layer of knowledge, a review and assessment of their understanding is necessary.

#### TEACHER NOTES

##### Electrode Potentials

When scientists first constructed voltaic (galvanic) electrochemical cells, they recorded net cell potentials (standard reduction potential,  $E^0$ ) that resulted from the reactions, but they did not know how much each half-cell contributed to the total net cell voltage. Many experiments were done in an attempt to determine the absolute  $E^0$  for any half-cell reaction.

During their experiments, chemists found that not only did temperature affect the net cell potential, but so did the concentration of ions in solution and the pressure, if a gas was used. Another term that is often used synonymously with *cell potential* is *electromotive force* (emf).

Many “reference” electrodes were tried before chemists chose the hydrogen half-cell as the standard against which all other electrodes would be measured. Students will readily see that this choice was reasonable, as the hydrogen half-cell reaction appears in the middle of the Standard Reduction Potentials table and has an emf value of 0.

#### General Learning Outcome Connections

**GLO D3:** Understand the properties and structures of matter, as well as various common manifestations and applications of the actions and interactions of matter.

**SKILLS AND ATTITUDES OUTCOME**

**C12-0-U1:** Use appropriate strategies and skills to develop an understanding of chemical concepts.

*Examples: analogies, concept frames, concept maps, manipulatives, particulate representations, role-plays, simulations, sort-and-predict frames, word cycles . . .*

**Standard Hydrogen Electrode**

In the hydrogen electrode diagram shown below, hydrogen gas ( $\text{H}_2$ ) is bubbled into hydrochloric acid ( $\text{HCl}$ ) solution at  $25^\circ\text{C}$ . The platinum electrode provides a surface on which the dissociation of hydrogen molecules can occur, as well as serving as an electrical conductor to the external circuit.

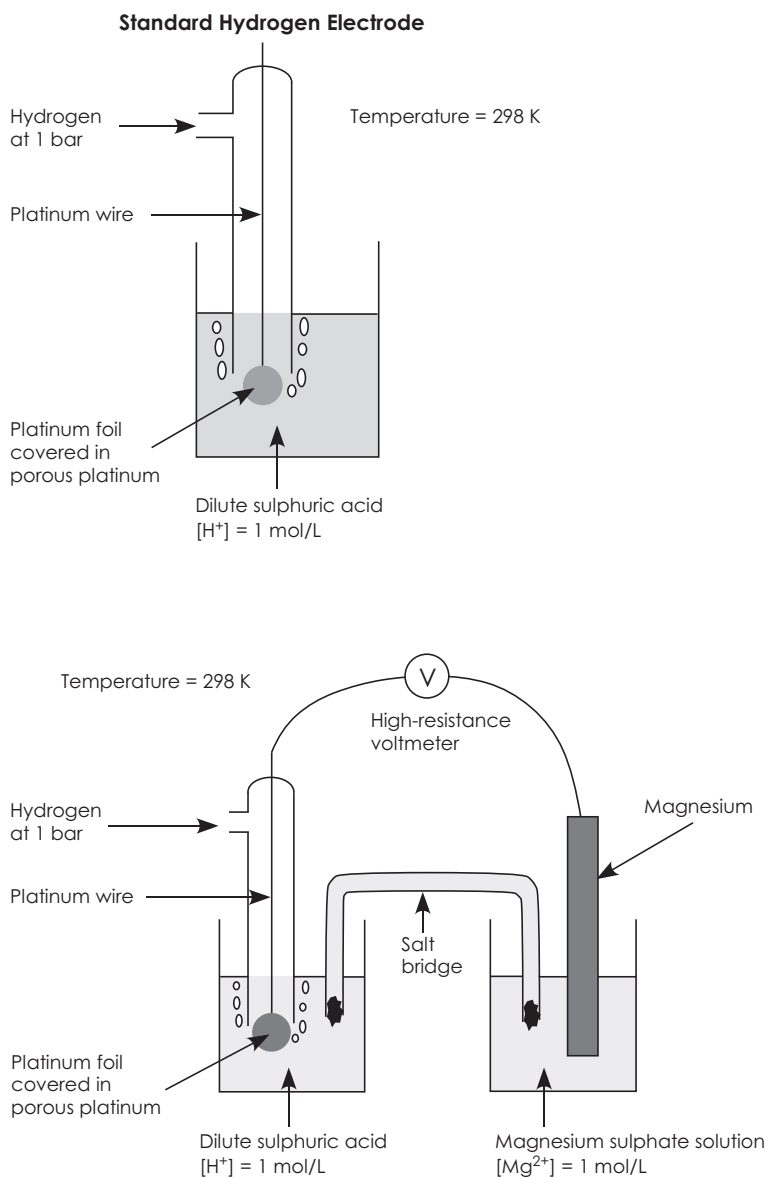

**Topic 6:**  
**Electrochemistry**

**SPECIFIC LEARNING OUTCOMES**

**C12-6-06:** Define *standard electrode potential*.

Include: hydrogen electrode as a reference

**C12-6-07:** Calculate standard cell potentials, given standard electrode potentials.

**C12-6-08:** Predict the spontaneity of reactions using standard electrode potentials.

(continued)

Under standard conditions of 1 atm for H<sub>2</sub> and 1 mol/L HCl, the potential for the reduction of H<sup>+</sup> at 25°C is taken to be exactly zero.



Once the standard half-cell had been chosen, scientists were able to use this cell to determine the electrode potential for all the other half-cell reactions on the electromotive series. These values were placed on a table of half-cell reactions containing Standard Reduction Potentials.

*Example:*

A galvanic cell with a zinc electrode and a standard hydrogen electrode (SHE).

During the reaction, the zinc electrode loses mass, indicating that the zinc electrode half-cell reaction must be

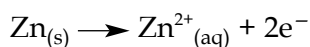

The shorthand notation for this cell is

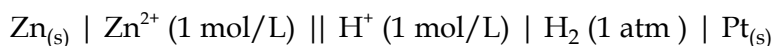

The half-cell reactions are as follows:

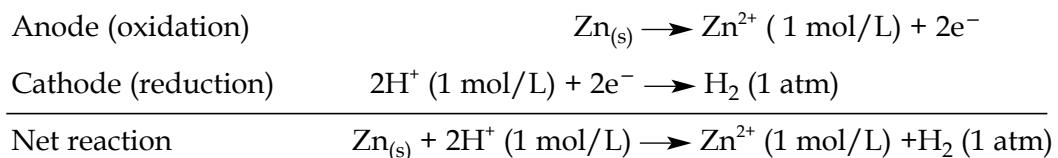

**SKILLS AND ATTITUDES OUTCOME****C12-0-U1:** Use appropriate strategies and skills to develop an understanding of chemical concepts.

Examples: analogies, concept frames, concept maps, manipulatives, particulate representations, role-plays, simulations, sort-and-predict frames, word cycles . . .

By convention, the standard emf of the cell,  $E^0_{\text{cell}}$ , composed of a contribution from the cathode and the anode, is given by

$$E^0_{\text{cell}} = E^0_{\text{cathode}} - E^0_{\text{anode}}$$

$$E^0_{\text{cell}} = E^0\left(\frac{\text{H}^+}{\text{H}_2}\right) - E^0\left(\frac{\text{Zn}^{2+}}{\text{Zn}}\right) \quad \left(\text{the voltage was measured for the cell at } 0.76 \text{ V}\right)$$

$$0.76 \text{ V} = 0 - E^0\left(\frac{\text{Zn}^{2+}}{\text{Zn}}\right) \quad \left(\text{solving for } E^0\left(\frac{\text{Zn}^{2+}}{\text{Zn}}\right)\right)$$

$$E^0\left(\frac{\text{Zn}^{2+}}{\text{Zn}}\right) = -0.76 \text{ V}$$

In a similar way, all electrode potentials were determined and placed together with their half-cell reactions on a table that chemists call the Standard Electrode Potentials.

Students should now be shown how to determine the net cell emf using half-cell reactions from the table of Standard Reduction Potentials.

**Using the Standard Reduction Potentials Table**

The table is organized according to the tendency of a substance to gain electrons, which is its *reduction potential*. For every redox reaction, the half-reaction that is more positive will proceed as a *reduction reaction*, and the half-reaction that is more negative will proceed as an *oxidation reaction*.

The Standard Reduction Potentials table is used to determine spontaneity and electrical potential of a given cell. Any *positive cell potential* value determined by finding the difference between the cathode and anode half-reaction potentials will result in a *spontaneous redox reaction*. Any *negative cell potential* value will indicate a *non-spontaneous redox reaction*.

*Example:*

Calculate the cell potential for a silver-copper cell.

1. Find the half-reactions for silver and copper from the Standard Reduction Potentials table.

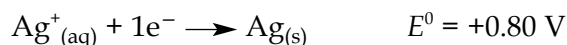
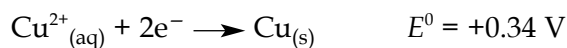

## Topic 6: Electrochemistry

### SPECIFIC LEARNING OUTCOMES

**C12-6-06:** Define *standard electrode potential*.

Include: hydrogen electrode as a reference

**C12-6-07:** Calculate standard cell potentials, given standard electrode potentials.

**C12-6-08:** Predict the spontaneity of reactions using standard electrode potentials.

(continued)

Since  $\text{Ag}^+$  ions are more easily reduced than  $\text{Cu}^{2+}$  ions,

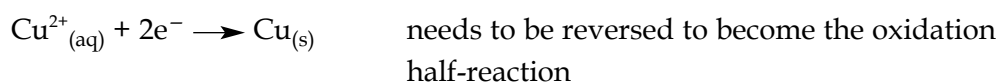
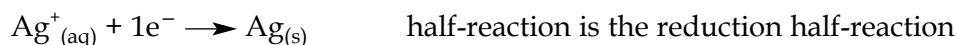

Another way of saying this is that the  $\text{Ag}^+$  has a greater affinity for electrons than the  $\text{Cu}^{2+}$  ion and, as a result, the reaction with the lower + emf will become the oxidation reaction. When reversing any half-reaction, the sign of the reduction potential is also reversed.

Therefore, the oxidation half-reaction will be



- Substitute the half-cell potentials into the equation.

$$E^0_{\text{cell}} = E^0_{\text{oxidation}} + E^0_{\text{reduction}} = (-0.34 \text{ V}) + (+0.80 \text{ V}) = +0.46 \text{ V}$$

This cell has a potential of +0.46 V and confirms its spontaneity.

#### Note:

Chemistry texts will often show two methods for the calculation of  $E^0$  cell:

$$E^0_{\text{cell}} = E^0_{\text{oxidation}} + E^0_{\text{reduction}}$$

$$E^0_{\text{cell}} = E^0_{\text{cathode}} - E^0_{\text{anode}}$$

Either relationship will produce the correct result.

Students may also use the formula  $E^0_{\text{cell}} = E^0_{\text{reduction}} - E^0_{\text{oxidation}}$  to obtain cell potential. Then they do not have to flip positive and negative signs before calculating values.

For a summary of the Standard Reduction Potentials, refer to *Chemistry* (Chang 825–830).

**SKILLS AND ATTITUDES OUTCOME**

**C12-0-U1:** Use appropriate strategies and skills to develop an understanding of chemical concepts.

*Examples: analogies, concept frames, concept maps, manipulatives, particulate representations, role-plays, simulations, sort-and-predict frames, word cycles . . .*

**SUGGESTIONS FOR ASSESSMENT****Paper-and-Pencil Tasks****Part A**

Students should be able to answer questions such as the following about the standard hydrogen electrode.

1. What was the necessity of finding the standard hydrogen electrode?

*Answer:*

Any given pair of electrodes will give a specific cell potential, but to compare the relative strengths of the electrodes on cell dynamics, scientists needed to find a cell to which all others could be compared. Many reference cells were initially used, but the hydrogen cell conveniently fell in the middle of the table of Standard Reduction Potentials.

2. What would the table have looked like if chemists had chosen a standard electrode other than the standard hydrogen electrode?

*Answer:*

If another cell were used instead of hydrogen, the reactions would still be in the same order of electron affinity; however, the new reference cell would be given the value of zero and all the others would then be compared to that cell. On either side of the new reference, positive and negative numbers would become larger, moving away from the reference cell.

**Part B**

Students should be able to find the net (overall) cell potential of a given reaction or electrochemical cell and predict whether the reaction will be spontaneous, and explain why or why not.

1. Complete the following reactions based on a Standard Reduction Potentials table. Calculate the net cell potential and indicate the reason why the reaction proceeds spontaneously as written.

Answers will vary, depending on the tables used.

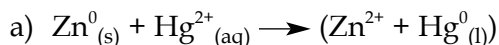

*Answer:*

$$E_{\text{cell}} = +1.54 \text{ V}$$

This cell would run spontaneously. The net cell voltage is positive.

## Topic 6: Electrochemistry

### SPECIFIC LEARNING OUTCOMES

**C12-6-06:** Define *standard electrode potential*.

Include: hydrogen electrode as a reference

**C12-6-07:** Calculate standard cell potentials, given standard electrode potentials.

**C12-6-08:** Predict the spontaneity of reactions using standard electrode potentials.

(continued)

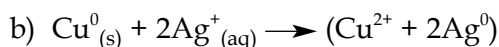

*Answer:*

$$E_{\text{cell}} = +0.46 \text{ V}$$

This cell would run spontaneously. The net cell voltage is positive.

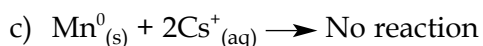

*Answer:*

$$E_{\text{cell}} = -1.74 \text{ V}$$

This cell would not function. The net cell voltage is negative.

### Part C

For each of the following situations, have students write balanced net ionic reactions, indicate the oxidation and reduction reactions, specify the cell emf, and predict whether the reaction will be spontaneous, briefly explaining why or why not.

- In the Middle Ages, iron was used to make pots and pans. Could a solution of copper(II) acetate be stored in such an iron container? Explain your answer with reactions and a discussion of emf.

*Answer:*

The acetate ion does not occur in the Standard Reduction Potentials table and is, therefore, a spectator ion. The expected reaction will be

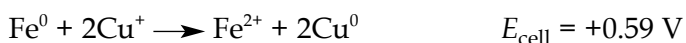

As the net cell potential is positive, a reaction would occur spontaneously. It would not be a good idea to store the solution in an iron container.

The iron metal is oxidized to  $\text{Fe}^{2+}$ , and the  $\text{Cu}^+$  is reduced to elemental copper.



**SKILLS AND ATTITUDES OUTCOME**

**C12-0-U1:** Use appropriate strategies and skills to develop an understanding of chemical concepts.

*Examples: analogies, concept frames, concept maps, manipulatives, particulate representations, role-plays, simulations, sort-and-predict frames, word cycles . . .*

2. A lead(II) nitrate solution is poured into a container in which a piece of zinc metal has been placed.

*Answer:*

The nitrate ion only reacts when it is placed in an acidic solution, so in this example it will be a spectator ion. The expected reaction will be

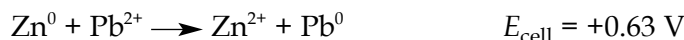

As the net cell potential is positive, a reaction will occur between the zinc metal and the lead solution.

The zinc metal is oxidized to  $\text{Zn}^{2+}$ , and the  $\text{Pb}^{2+}$  ion is reduced to metallic lead.

3. What metal container(s) could be used to hold a 0.20 mol/L solution of copper(I) acetate safely? Explain your answer.

*Answer:*

The acetate ion does not appear in the Standard Reduction Potentials table, and so it will be a spectator ion.

$\text{Cu}^+$  appears in the following reduction reaction:



For a reaction to occur, the species must be above  $\text{Cu}^+$  and to the left on the Standard Reduction Potentials table for the net cell potential to be positive. So, we must be looking for a metal below  $\text{Cu}^+$ . Possible containers in which a 0.20 mol/L solution of copper(I) acetate could, therefore, be  $\text{Pb}^0$ ,  $\text{Sn}^0$ ,  $\text{Ni}^0$ ,  $\text{Co}^0$ ,  $\text{Fe}^0$ ,  $\text{Cr}^0$ , and so on.

**Extension/Enrichment**

Students have used Le Châtelier's principle in their discussion of chemical equilibria in acid-base chemistry and solubility. Le Châtelier's principle applies equally to electrochemical cells.

Students already know that when a stress is placed on a system at equilibrium, the reaction shifts so as to offset or ameliorate the stress applied. After studying Grade 11 and Grade 12 chemistry, students know that as a reaction proceeds, the reactants decrease and the products increase. Have students consider what could be done to an electrochemical cell to prolong the voltage, given that the initial emf will decrease over time.

## Topic 6: Electrochemistry

### SPECIFIC LEARNING OUTCOMES

**C12-6-06:** Define *standard electrode potential*.

Include: hydrogen electrode as a reference

**C12-6-07:** Calculate standard cell potentials, given standard electrode potentials.

**C12-6-08:** Predict the spontaneity of reactions using standard electrode potentials.

(continued)

The following example uses a Daniell cell to explore the effects of adding or removing substances from a system.

Recall that a Daniell cell is a special case of a voltaic (galvanic) cell having the net reaction of:

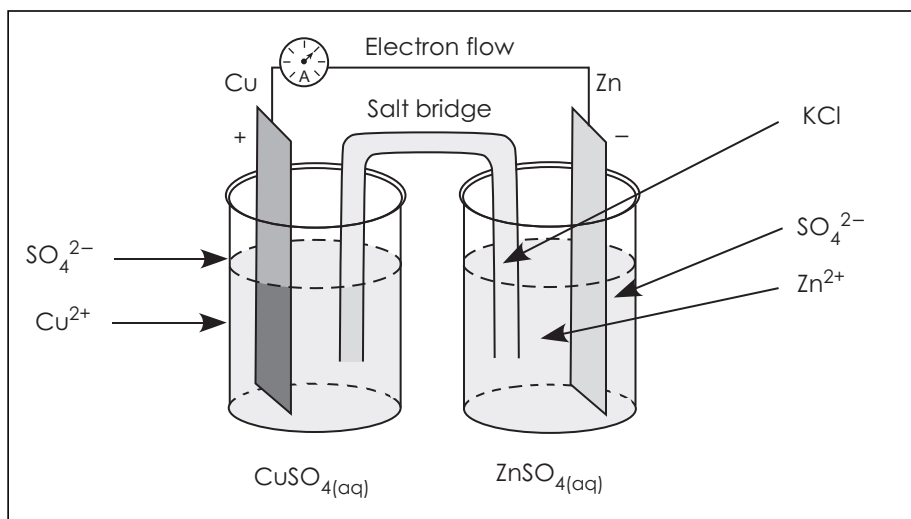
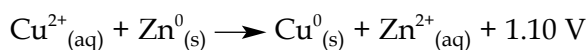

### Facts

- Immediately after the circuit is connected, the voltage will begin to decrease from an emf of 1.10 V.
- The blue colour in the cathodic (reduction) cell due to the  $\text{Cu}^{2+}_{(\text{aq})}$  ion will become less dark as the ions are reduced to solid copper atoms that are deposited on the copper cathode.
- The concentration of  $\text{Zn}^{2+}_{(\text{aq})}$  ions will increase around the zinc anode.

As a result, the concentration of reactants will continue to decrease and the concentration of products will increase.

**SKILLS AND ATTITUDES OUTCOME**

**C12-0-U1:** Use appropriate strategies and skills to develop an understanding of chemical concepts.

*Examples: analogies, concept frames, concept maps, manipulatives, particulate representations, role-plays, simulations, sort-and-predict frames, word cycles . . .*

Effects to consider using Le Châtelier's principle include the following:

- The addition of  $\text{Cu}^{2+}_{(\text{aq})}$  ions in any form using a soluble salt of  $\text{Cu}^{2+}_{(\text{aq})}$  will have a tendency to move the equilibrium in the forward direction.
- The removal of  $\text{Zn}^{2+}_{(\text{aq})}$  ions by the addition of a precipitating anion will effectively remove soluble  $\text{Zn}^{2+}_{(\text{aq})}$  to a solid form that will precipitate (e.g., sulphide ion  $\text{S}^{-}$ ), forming solid  $\text{ZnS}$  (e.g., hydroxide  $\text{OH}^{-}$  ion), forming solid  $\text{Zn}(\text{OH})_2$ , and so on.

**Journal Writing/Process Notes**

Students can

- provide reasons for the great attention currently being given to electrochemistry
- “write the steps for the process of predicting whether any proposed redox reaction will occur spontaneously” (Fisher 287)
- explain the difference between positive and negative  $E_{\text{cell}}$  values (Fisher 286)

**LEARNING RESOURCES LINKS**

*Chemistry*, 9th ed. (Chang 825–830)

*Glencoe Chemistry: Matter and Change* (Dingrando, et al.)

Table 21-1: Standard Reduction Potentials at 25°C, 1 atm, and 1M Ion Concentration, 667

*Glencoe Chemistry: Matter and Change, Science Notebook* (Fisher 286, 287)

*Prentice Hall Chemistry* (Wilbraham, et al.)

Table 21.2: Reduction Potentials at 25°C with 1M Concentration of Aqueous Species, 674

**Selecting Learning Resources**

For additional information on selecting learning resources for Grade 11 and Grade 12 Chemistry, see the Manitoba Education website at <[www.edu.gov.mb.ca/k12/learnres/bibliographies.html](http://www.edu.gov.mb.ca/k12/learnres/bibliographies.html)>.

## Topic 6: Electrochemistry

### SPECIFIC LEARNING OUTCOMES

**C12-6-09:** Compare and contrast voltaic (galvanic) and electrolytic cells.

**C12-6-10:** Explain the operation of an electrolytic cell at the visual, particulate, and symbolic levels.

Include: a molten ionic compound and an aqueous ionic compound

**C12-6-11:** Describe practical uses of electrolytic cells.

*Examples: electrolysis of water, electrolysis of brine, electroplating, production and purification of metals . . .*

(3.5 hours)

SLO: C12-6-09  
SLO: C12-6-10  
SLO: C12-6-11

### SUGGESTIONS FOR INSTRUCTION

#### Entry-Level Knowledge

The following study of electrolytic cells complements previous discussions of electrochemical cells; however, a review and assessment is necessary to secure students' prior knowledge before adding a new layer of related information.

#### TEACHER NOTES

*Electrolysis* is the process in which electrical energy is used to cause a non-spontaneous reaction to occur.

#### Demonstration: Electrolysis of Water

The electrolysis of water, a method by which hydrogen gas and oxygen gas can be generated, is an effective demonstration to begin the discussion of electrolytic cells even though it is generally a slow reaction.

The following schematic diagram shows how a simple apparatus can be used for the decomposition of water. Many teachers will be familiar with the equipment, since it is often found in chemistry labs. The Hofmann apparatus was designed by German chemist August Wilhelm von Hofmann for the electrolytic decomposition of water. As water is a relatively poor conductor of electricity, the use of a 0.1 mol/L solution of either hydrochloric acid or sulphuric acid will speed up the reaction.

#### General Learning Outcome Connections

**GLO A5:** Recognize that science and technology interact with and advance one another.

**GLO B2:** Recognize that scientific and technological endeavours have been and continue to be influenced by human needs and the societal context of the time.

**GLO D3:** Understand the properties and structures of matter, as well as various common manifestations and applications of the actions and interactions of matter.

**SKILLS AND ATTITUDES OUTCOMES**

**C12-0-U1:** Use appropriate strategies and skills to develop an understanding of chemical concepts.

*Examples: analogies, concept frames, concept maps, manipulatives, particulate representations, role-plays, simulations, sort-and-predict frames, word cycles . . .*

**C12-0-U2:** Demonstrate an understanding of chemical concepts.

*Examples: use accurate scientific vocabulary, explain concepts to others, compare and contrast concepts, apply knowledge to new situations and/or contexts, create analogies, use manipulatives . . .*

**C12-0-R4:** Compare diverse perspectives and interpretations in the media and other information sources.

**C12-0-T3:** Provide examples of how chemical principles are applied in products and processes, in scientific studies, and in daily life.

**C12-0-A4:** Be sensitive and responsible in maintaining a balance between the needs of humans and a sustainable environment.

**Hofmann Apparatus**

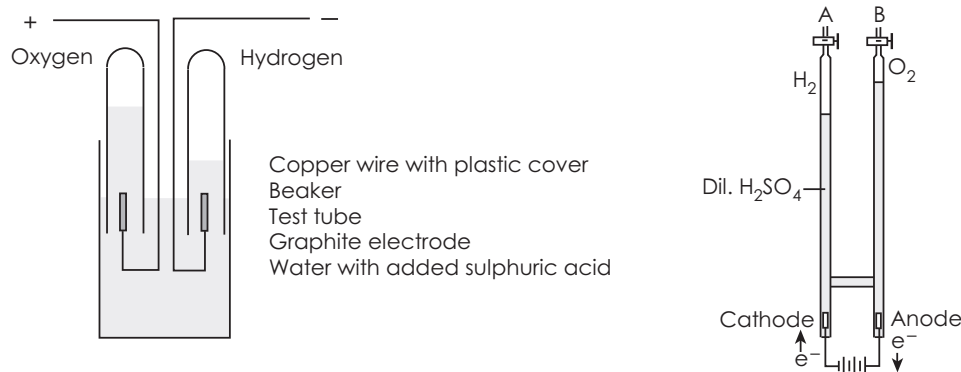

The addition of universal indicator to the acidic solution will cause a colour change when the reaction begins. The colour will also help the observer to note the difference in the volumes of gas produced.

The volume of gas is related to the empirical formula of water and, therefore, twice as much hydrogen gas is produced as oxygen gas. A glowing splint can be used to identify whether a gas is oxygen or hydrogen. If the splint glows brighter, the gas is oxygen, and if there is a popping sound, the gas is hydrogen.

## Topic 6: Electrochemistry

### SPECIFIC LEARNING OUTCOMES

**C12-6-09:** Compare and contrast voltaic (galvanic) and electrolytic cells.

**C12-6-10:** Explain the operation of an electrolytic cell at the visual, particulate, and symbolic levels.

Include: a molten ionic compound and an aqueous ionic compound

**C12-6-11:** Describe practical uses of electrolytic cells.

*Examples: electrolysis of water, electrolysis of brine, electroplating, production and purification of metals . . .*

(continued)

### Comparison of Electrochemical and Electrolytic Cells

The following table compares electrochemical (voltaic) and electrolytic cells.

Comparison of Electrochemical and Electrolytic Cells		
	Electrochemical Cell	Electrolytic Cell
Reaction spontaneity	Spontaneous	Non-spontaneous
Cell potential	Positive	Negative
Electricity	Produces	Consumes
Electrode charge*	Cathode (+) Anode (-)	Cathode (+) Anode (-)
Cathode	Reduction	Reduction
Anode	Oxidation	Oxidation
Change in energy	Converts chemical energy to electrical energy	Converts electrical energy to chemical energy
* The discussion of electrode charge can be confusing to students, and should have a lower priority than the discussion of chemical processes that occur at each electrode.		

### The Operation of an Electrolytic Cell

Students should be able to describe the processes involved in the operation of electrolytic cells in terms of the various modes of representation (visual, particulate, and symbolic), just as they were expected to for electrochemical cells. The particulate nature of matter is just as relevant with electrolytic cells.

## SKILLS AND ATTITUDES OUTCOMES

**C12-0-U1:** Use appropriate strategies and skills to develop an understanding of chemical concepts.

*Examples: analogies, concept frames, concept maps, manipulatives, particulate representations, role-plays, simulations, sort-and-predict frames, word cycles . . .*

**C12-0-U2:** Demonstrate an understanding of chemical concepts.

*Examples: use accurate scientific vocabulary, explain concepts to others, compare and contrast concepts, apply knowledge to new situations and/or contexts, create analogies, use manipulatives . . .*

**C12-0-R4:** Compare diverse perspectives and interpretations in the media and other information sources.

**C12-0-T3:** Provide examples of how chemical principles are applied in products and processes, in scientific studies, and in daily life.

**C12-0-A4:** Be sensitive and responsible in maintaining a balance between the needs of humans and a sustainable environment.

A labelled diagram of an electrolytic cell is provided below. Note the similarities of an electrolytic cell to an electrochemical cell. One of the differences in the setup of the apparatus is that in an electrolytic cell, a source of electricity is required to push the usually non-spontaneous reaction to occur, whereas in an electrochemical cell, the cell generates electricity through a spontaneous chemical reaction. Another difference is that in an electrolytic cell, both reactions occur in the same container, whereas separate containers are needed for each electrode in an electrochemical cell.

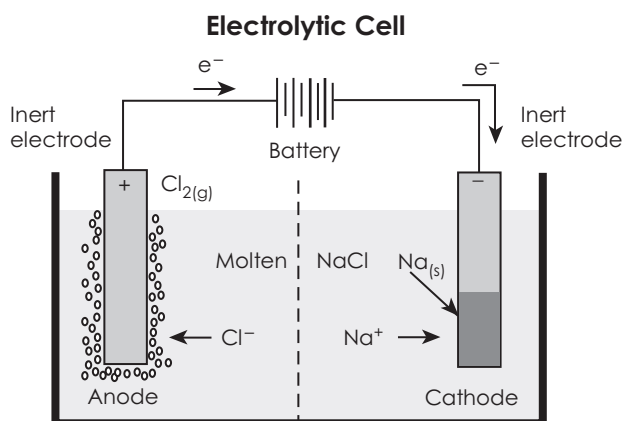

The following items should be included in a diagram of an electrolytic cell: a container, an electrolytic solution (acid, base, or salt), the two electrodes, an external electron “pump” (battery), the positive electrode of the battery connected to the anode, and the negative electrode of the battery connected to the cathode. Half-cell reactions and the net reaction are still necessary.

There are two different types of electrolytic cells:

- The more straightforward cell occurs when electricity is applied to a molten solution. The industrial applications of this particular cell will be discussed later.
- The second type of cell occurs when electricity is applied to an aqueous solution. This cell is complicated by the fact that there are many more species that can be oxidized and reduced.

## Topic 6: Electrochemistry

### SPECIFIC LEARNING OUTCOMES

**C12-6-09:** Compare and contrast voltaic (galvanic) and electrolytic cells.

**C12-6-10:** Explain the operation of an electrolytic cell at the visual, particulate, and symbolic levels.

Include: a molten ionic compound and an aqueous ionic compound

**C12-6-11:** Describe practical uses of electrolytic cells.

*Examples: electrolysis of water, electrolysis of brine, electroplating, production and purification of metals . . .*

(continued)

### Electrolysis of Molten Solutions

Molten solutions are melted forms of the pure substance. Obviously, the electrolytic cell container would be made of material that could withstand the high temperatures required to maintain the solution in the molten state. A diagram of an industrial electrolytic cell follows.

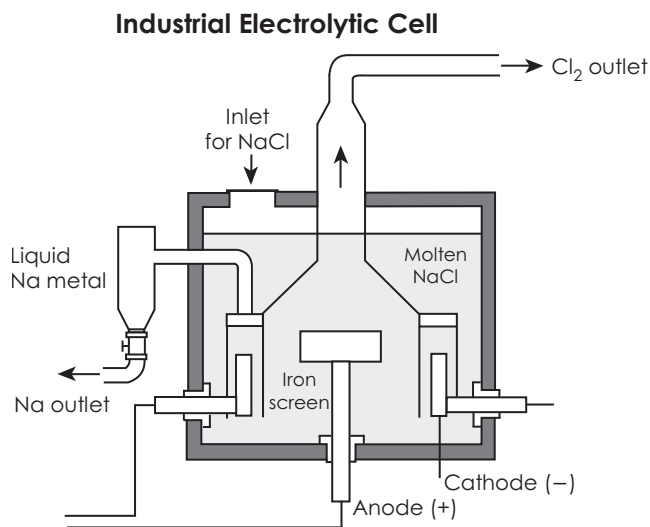

The negative side of the battery is connected to the cathode. In an electrolytic cell, as in an electrochemical cell, the cations move towards the cathode and the anions to the anode, according to the following reactions:

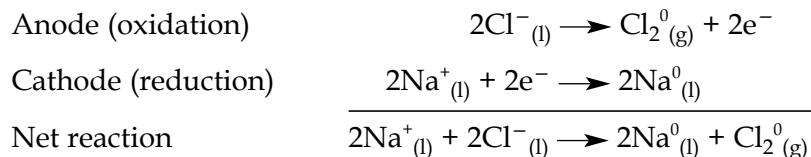

This reaction is used to produce pure supplies of sodium and chlorine gas.



**SKILLS AND ATTITUDES OUTCOMES**

**C12-0-U1:** Use appropriate strategies and skills to develop an understanding of chemical concepts.

*Examples: analogies, concept frames, concept maps, manipulatives, particulate representations, role-plays, simulations, sort-and-predict frames, word cycles . . .*

**C12-0-U2:** Demonstrate an understanding of chemical concepts.

*Examples: use accurate scientific vocabulary, explain concepts to others, compare and contrast concepts, apply knowledge to new situations and/or contexts, create analogies, use manipulatives . . .*

**C12-0-R4:** Compare diverse perspectives and interpretations in the media and other information sources.

**C12-0-T3:** Provide examples of how chemical principles are applied in products and processes, in scientific studies, and in daily life.

**C12-0-A4:** Be sensitive and responsible in maintaining a balance between the needs of humans and a sustainable environment.

**Electrolysis of Aqueous Brine Solution**

Teachers should carefully review their own knowledge of the following information before teaching it to students.

The electrolysis of brine (a saturated solution of sodium chloride), produces chlorine gas, hydrogen gas, and sodium hydroxide. The presence of water adds species that could either oxidize or be reduced.

An examination of the Standard Reduction Potentials table shows that the following oxidation reactions could occur at the anode:

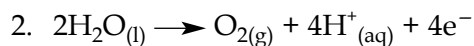

According to the table, both reactions have been reversed, and must be written as follows:

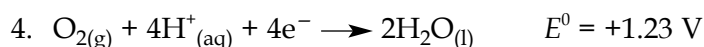
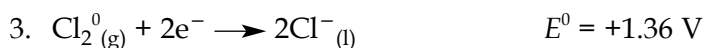

The half-cell emf values are close, but still indicate that for the reverse oxidation reaction, the  $\text{H}_2\text{O}_{(\text{l})}$  should be the first to be oxidized. However, it has been found experimentally that a much higher potential is required to oxidize water, and in fact  $\text{Cl}_{2(\text{g})}$  is produced, and not  $\text{O}_{2(\text{g})}$ . The voltage required for the oxidation reaction in excess of the expected value is called the *overvoltage*. The causes of overvoltage are very complex. In simple terms, a greater voltage is caused by difficulties encountered by the various species transferring electrons to atoms on the electrode/solution interface. As a result of this anomaly,  $E^0$  values must be used cautiously in predicting the actual order of the oxidation or reduction of species in aqueous solutions.

## Topic 6: Electrochemistry

### SPECIFIC LEARNING OUTCOMES

**C12-6-09:** Compare and contrast voltaic (galvanic) and electrolytic cells.

**C12-6-10:** Explain the operation of an electrolytic cell at the visual, particulate, and symbolic levels.

Include: a molten ionic compound and an aqueous ionic compound

**C12-6-11:** Describe practical uses of electrolytic cells.

*Examples: electrolysis of water, electrolysis of brine, electroplating, production and purification of metals . . .*

(continued)

Similarly, the following reduction reactions could occur at the cathode:

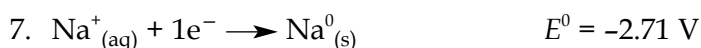
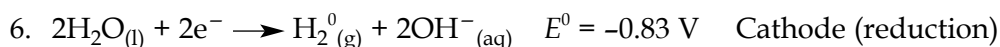
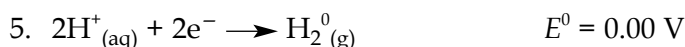

According to the Standard Reduction Potentials table, the species that is most readily reduced is No. 5; however, in an aqueous salt solution at a pH of 7, the concentration of  $\text{H}^+_{(\text{aq})}$  would be too low to consider at  $1 \times 10^{-7}$  mol/L.

Consequently, the preferred reaction at the cathode would be No. 6.

The reactions for the electrolysis of aqueous brine solution would be as follows:

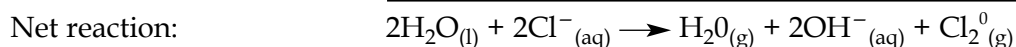

### Research: Applications of Electrolytic Cells

Many useful reactions centre on the use of electricity to produce chemical changes. If time permits, encourage students to research the applications of electrolytic cells. According to the media, fuel cells appear to be the energy of the future. Chemistry texts, such as those cited as Learning Resources Links, provide topical discussions of electrolytic cells.

1. Electrolysis of brine (a saturated solution of sodium chloride) is used for the purification of water and collection of sodium hydroxide, hydrogen, and chlorine (also known as the *chloro-alkali process*).
2. Electrolysis of molten sodium chloride within a *Down's cell* is used to obtain elemental sodium and chlorine gas.
3. Aluminum metal is obtained by the electrolysis of aluminum oxide, which is refined from bauxite ore.

**SKILLS AND ATTITUDES OUTCOMES**

**C12-0-U1:** Use appropriate strategies and skills to develop an understanding of chemical concepts.

*Examples: analogies, concept frames, concept maps, manipulatives, particulate representations, role-plays, simulations, sort-and-predict frames, word cycles . . .*

**C12-0-U2:** Demonstrate an understanding of chemical concepts.

*Examples: use accurate scientific vocabulary, explain concepts to others, compare and contrast concepts, apply knowledge to new situations and/or contexts, create analogies, use manipulatives . . .*

**C12-0-R4:** Compare diverse perspectives and interpretations in the media and other information sources.

**C12-0-T3:** Provide examples of how chemical principles are applied in products and processes, in scientific studies, and in daily life.

**C12-0-A4:** Be sensitive and responsible in maintaining a balance between the needs of humans and a sustainable environment.

4. Extraction is the process by which a metal is obtained from an ore. Reactive metals, including lithium, beryllium, magnesium, calcium, and radium, are extracted industrially by the electrolysis of their molten chlorides.
5. Refining/purification of metal occurs following extraction. During this process, impurities are removed electrolytically to produce pure metals, such copper or nickel. The result is 99.99% pure metals.
6. Electroplating coats an object with a thin layer of protective/decorative metal, such as copper or silver.
7. Galvanizing is a process in which iron is covered with a protective layer of zinc.
8. Cathodic protection is a method of preventing rusting in which a more reactive metal (sacrificial anode) is attached to an object. For example, this method is used to protect ship hulls, oil and gas pipelines, boat motors, underground iron pipes, and gasoline storage tanks.

**Class Discussion**

Discuss the environmental impact of mining and extraction procedures and the implications for sustainability.

**Laboratory Activity/Demonstration**

Construct (or have students construct) an electrolytic cell using a solution of copper(II) sulphate, a copper metal strip, a nickel or quarter coin, and a 6-V battery. The copper from the solution plates onto the nickel. Reversing the current removes the plated copper from the nickel.

**Topic 6:**  
**Electrochemistry**

---

**SPECIFIC LEARNING OUTCOMES**

**C12-6-09:** Compare and contrast voltaic (galvanic) and electrolytic cells.

**C12-6-10:** Explain the operation of an electrolytic cell at the visual, particulate, and symbolic levels.

Include: a molten ionic compound and an aqueous ionic compound

**C12-6-11:** Describe practical uses of electrolytic cells.

*Examples: electrolysis of water, electrolysis of brine, electroplating, production and purification of metals . . .*

(continued)

---

**SUGGESTIONS FOR ASSESSMENT**

---

**Paper-and-Pencil Tasks**

1. Have students demonstrate their ability to calculate the cell potential of electrolytic cells.
2. Ask students to draw a diagram of an electrolytic cell on which they identify the positive and negative electrodes, anode, cathode, half-cell reactions, direction of electron flow, direction of ion flow, solutions used, the net cell reaction, the electrode that erodes, and the electrode that plates.
3. Have students explain the complete operation of a working electrolytic cell in terms of the three modes of representation: visual, particulate, and symbolic.

**Compare and Contrast**

Students can complete a Compare and Contrast think sheet for electrolytic and electrochemical cells (see *SYSTH* 10.24).

**Research Project**

Students can research electrolytic processes by conducting an Article Analysis (see *SYSTH* 11.30, 11.40, 11.41) or by creating a poster. The projects should emphasize local applications, where relevant.

**SKILLS AND ATTITUDES OUTCOMES**

**C12-0-U1:** Use appropriate strategies and skills to develop an understanding of chemical concepts.

*Examples: analogies, concept frames, concept maps, manipulatives, particulate representations, role-plays, simulations, sort-and-predict frames, word cycles . . .*

**C12-0-U2:** Demonstrate an understanding of chemical concepts.

*Examples: use accurate scientific vocabulary, explain concepts to others, compare and contrast concepts, apply knowledge to new situations and/or contexts, create analogies, use manipulatives . . .*

**C12-0-R4:** Compare diverse perspectives and interpretations in the media and other information sources.

**C12-0-T3:** Provide examples of how chemical principles are applied in products and processes, in scientific studies, and in daily life.

**C12-0-A4:** Be sensitive and responsible in maintaining a balance between the needs of humans and a sustainable environment.

**LEARNING RESOURCES LINKS**

*Glencoe Chemistry: Matter and Change* (Dingrando, et al.)  
Section 21.3: Electrolysis, 683

*Prentice Hall Chemistry* (Wilbraham, et al.)  
Section 21.3: Electrolytic Cells, 678

**Investigations**

*Glencoe Chemistry: Matter and Change: Laboratory Manual* (Dingrando, et al.)  
Lab 21.2: Electroplating, 165

*Prentice Hall Chemistry: Laboratory Manual* (Wilbraham, Staley, and Matta)  
Experiment 48: Electrochemistry, 287 (constructing electrolytic cells)

**Selecting Learning Resources**

For additional information on selecting learning resources for Grade 11 and Grade 12 Chemistry, see the Manitoba Education website at <[www.edu.gov.mb.ca/k12/learnres/bibliographies.html](http://www.edu.gov.mb.ca/k12/learnres/bibliographies.html)>.

**Topic 6:**  
**Electrochemistry**

**SPECIFIC LEARNING OUTCOME**

**C12-6-12:** Solve problems related to electrolytic cells, using Faraday's law.

(2 hours)

SLO: C12-6-12

**SUGGESTIONS FOR INSTRUCTION**

**Entry-Level Knowledge**

In their discussion of electricity in Grade 9 Science, students learned that the quantity of electric charge is equal of the product of the current and time. Teachers should help students review prior knowledge before proceeding with new information.

**TEACHER NOTES**

**Faraday's Law**

English chemist and physicist Michael Faraday (1791–1867) experimented extensively to determine the stoichiometric relationship between electric charge and chemical energy. He determined that the amount of substance produced or consumed in an electrolysis reaction is directly proportional to the quantity of electricity that flows through the circuit.

An ampere is defined as 1 coulomb flowing through a conductor in 1 second.

Amperage = coulombs/second, or rearranged as

$$Q = I\Delta t$$

Q = charge (coulombs)

I = current (amperes)

$\Delta t$  = change in time (seconds)

**General Learning Outcome Connections**

**GLO A4:** Identify and appreciate contributions made by women and men from many societies and cultural backgrounds that have increased our understanding of the world and brought about technological innovations.

**GLO B1:** Describe scientific and technological developments—past and present—and appreciate their impact on individuals, societies, and the environment, both locally and globally.

**GLO D3:** Understand the properties and structures of matter, as well as various common manifestations and applications of the actions and interactions of matter.

**GLO D4:** Understand how stability, motion, forces, and energy transfers and transformations play a role in a wide range of natural and constructed contexts.

**SKILLS AND ATTITUDES OUTCOMES**

**C12-0-U1:** Use appropriate strategies and skills to develop an understanding of chemical concepts.

*Examples: analogies, concept frames, concept maps, manipulatives, particulate representations, role-plays, simulations, sort-and-predict frames, word cycles . . .*

**C12-0-U2:** Demonstrate an understanding of chemical concepts.

*Examples: use accurate scientific vocabulary, explain concepts to others, compare and contrast concepts, apply knowledge to new situations and/or contexts, create analogies, use manipulatives . . .*

**C12-0-N2:** Describe, from a historical perspective, how the observations and experimental work of many individuals led to modern understandings of matter.

**C12-0-T1:** Describe examples of the relationship between chemical principles and applications of chemistry.

**C12-0-T3:** Provide examples of how chemical principles are applied in products and processes, in scientific studies, and in daily life.

Faraday's constant ( $F$ ) is the quantity of electricity carried by 1 mole of electrons.

$$\begin{aligned} 1 \text{ faraday} &= \text{Avogadro's number} \times \text{the charge on an electron} \\ &= 6.02 \times 10^{23} \cdot \text{mol}^{-1} \times 1.602192 \times 10^{-19} \text{ coulombs} \cdot \text{electron}^{-1} \\ &= 96\,484 \text{ coulombs} \cdot \text{mole of electrons}^{-1} \\ &= 96\,500 \text{ coulombs/mole of electrons (rounded)} \end{aligned}$$

By combining electric current and Faraday's constant, chemists have a simple way to calculate how much electricity is required to produce a mole of product at a given electrode. The solid is usually deposited at the cathode.

$$\text{Moles of electrons} = \frac{\text{amp} \times \text{s}}{96\,500}$$

Depending on the problem, we use two different units for 96 500:

$$\frac{96\,500 \text{ amp} \cdot \text{s}}{\text{mole of electrons}}$$

or

$$\frac{96\,500 \text{ coulombs}}{\text{mole of electrons}}$$

We can then use unit analysis to confirm calculations and the correct units.

In class discussions, emphasize the proportionality of ion charge to the grams liberated (deposited) from a solution (molten or aqueous salt) during the passage of 1 mole of electrons.

**Topic 6:**  
**Electrochemistry**

## SPECIFIC LEARNING OUTCOME

**C12-6-12:** Solve problems related to electrolytic cells, using Faraday's law.

(continued)

The following table illustrates the relationship between moles of electrons and the half-cell reactions.

Relationship between Moles of Electrons and Half-Cell Reactions				
Solution or Molten Salt	Ion	Oxidation Number	Gram Equivalent Weight	Grams of Element Produced
NaCl	Na <sup>+</sup>	+1	23 g ÷ 1	23 g Na/faraday
HCl	Cl <sup>-</sup>	-1	35.5 g ÷ 1	35.5 g Cl/faraday
MgCl <sub>2</sub>	Mg <sup>2+</sup>	+2	24.3 g ÷ 2	12.2 g Mg/faraday
Al <sub>2</sub> (SO <sub>4</sub> ) <sub>3</sub>	Al <sup>3+</sup>	+3	27 g ÷ 3	9 g Al/faraday

Note that with Mg<sup>2+</sup>, twice as many moles of electrons (electricity) are required to discharge 1 mole of Mg than to discharge 1 mole of Na. Since there is 1 mole of electrons in a faraday, only half a mole, or 12.2 g, of Mg metal is deposited. As shown in the previous table, 1 faraday (96 500 coulombs) is required to discharge 1 mole of Na<sup>+</sup> ions, 2 faradays of electricity are needed to discharge 1 mole of Mg<sup>2+</sup> ions, and 3 faradays are needed to discharge 1 mole of Al<sup>3+</sup> ions.

### Solving Problems Using Faraday's Law

Have students solve problems related to electrolytic cells, using Faraday's law. Some sample problems and solutions follow.

*Example 1:*

How many coulombs of current would be produced if 12.0 amp flow for 15.0 minutes?

*Solution:*

$$\begin{aligned}
 Q &= I\Delta t \\
 &= \text{amp} \times \text{seconds} \\
 &= 12.0 \text{ amp} \times 15.0 \text{ min} \times 60 \text{ s/min} \\
 &= 10\,800 \text{ coulombs}
 \end{aligned}$$



**SKILLS AND ATTITUDES OUTCOMES**

**C12-0-U1:** Use appropriate strategies and skills to develop an understanding of chemical concepts.

*Examples: analogies, concept frames, concept maps, manipulatives, particulate representations, role-plays, simulations, sort-and-predict frames, word cycles . . .*

**C12-0-U2:** Demonstrate an understanding of chemical concepts.

*Examples: use accurate scientific vocabulary, explain concepts to others, compare and contrast concepts, apply knowledge to new situations and/or contexts, create analogies, use manipulatives . . .*

**C12-0-N2:** Describe, from a historical perspective, how the observations and experimental work of many individuals led to modern understandings of matter.

**C12-0-T1:** Describe examples of the relationship between chemical principles and applications of chemistry.

**C12-0-T3:** Provide examples of how chemical principles are applied in products and processes, in scientific studies, and in daily life.

*Example 2:*

If 7.85 amp flow through a molten solution of copper(I) chloride for 45.0 minutes, how many moles of electrons flow through the cell?

*Solution:*

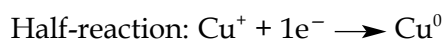

$$\text{Moles of electrons} = \frac{\text{amp} \times \text{s}}{96\,500}$$

$$\begin{aligned} \text{Moles of electrons} &= \frac{7.85 \cancel{\text{amp}} \times 45 \cancel{\text{min}} \times 60 \cancel{\text{s}}}{96\,500 \cancel{\text{amp}} \cdot \cancel{\text{s}} \cdot \text{mole of electrons}^{-1} \cdot \cancel{\text{min}}} \\ &= 0.220 \text{ mole of electrons} \end{aligned}$$

*Example 3:*

Calculate the grams of zinc deposited if 5.00 moles of electrons pass through a zinc sulphate solution.

*Solution:*

1. Write the reduction half-reaction.

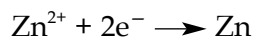

2. Use the mole ratio from the reaction.

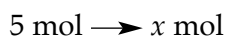
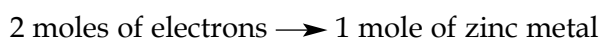

$$x = 2.50 \cancel{\text{mol}} \times 65.38 \text{ g} \cdot \cancel{\text{mol}}^{-1} \text{ or } 163.45 \text{ g (or } 164 \text{ g to 3 sig. figs.)}$$

## Topic 6: Electrochemistry

### SPECIFIC LEARNING OUTCOME

C12-6-12: Solve problems related to electrolytic cells, using Faraday's law.

(continued)

*Example 4:*

If 9.00 amp flow for 10.0 minutes through a molten silver fluoride solution, what mass of silver metal would be deposited at the cathode?

*Solution:*

The cathode reaction:  $\text{Ag}^+_{(\text{aq})} + 1\text{e}^{-1} = \text{Ag}^0_{(\text{s})}$

Therefore, according to the stoichiometry of the reaction, 1 mol of electrons produces 1 mol of Ag metal.

$$\text{Moles of electrons} = \frac{\text{amp} \times \text{s}}{96\,500}$$

$$\begin{aligned} \text{Moles of electrons} &= \frac{9.00 \text{ amp} \times 10.0 \text{ min} \times 60 \cancel{\text{s}}}{96\,500 \text{ amp} \cdot \cancel{\text{s}} \cdot \text{mole of electrons}^{-1} \cdot \cancel{\text{min}}} \\ &= 0.0560 \text{ mole of electrons} \rightarrow 0.0560 \text{ mol of Ag} \times 107.9 \text{ g/mol} \\ &= 6.04 \text{ g of Ag to 3 sig. figs.} \end{aligned}$$

### Laboratory Activity

Students can perform a lab experiment in which a potassium iodide solution is electrolyzed using carbon electrodes.

#### Note:

Remember to have students present the redox projects they began preparing in Topic 1: Reactions in Aqueous Solutions.

**SKILLS AND ATTITUDES OUTCOMES**

**C12-0-U1:** Use appropriate strategies and skills to develop an understanding of chemical concepts.

*Examples: analogies, concept frames, concept maps, manipulatives, particulate representations, role-plays, simulations, sort-and-predict frames, word cycles . . .*

**C12-0-U2:** Demonstrate an understanding of chemical concepts.

*Examples: use accurate scientific vocabulary, explain concepts to others, compare and contrast concepts, apply knowledge to new situations and/or contexts, create analogies, use manipulatives . . .*

**C12-0-N2:** Describe, from a historical perspective, how the observations and experimental work of many individuals led to modern understandings of matter.

**C12-0-T1:** Describe examples of the relationship between chemical principles and applications of chemistry.

**C12-0-T3:** Provide examples of how chemical principles are applied in products and processes, in scientific studies, and in daily life.

**SUGGESTIONS FOR ASSESSMENT****Paper-and-Pencil Tasks**

When solving problems related to electrolytic cells, students should be able to calculate any specific variable, when given all the other variables.

*Examples:*

- Find the mass, given the cathode reaction, amperage, and time.
- Find the time required to deposit a given mass of metal at the cathode, given the amperage and the cation.
- Find the amperage required to deposit a given mass of metal at the cathode for a given time period.
- Find the volume of gas generated at the anode, given the amperage, the time, the gas produced, and the temperature and pressure of the gas liberated.

**Journal Writing**

Ask students to

- write an account of the various industrial uses of electrolytic cells
- discuss the environmental effects of using an electrochemical cell to manufacture pure elements

**LEARNING RESOURCES LINKS****Investigation**

*Essential Experiments for Chemistry* (Morrison and Scodellaro)  
Experiment 14E: Electrolytic Cells, 256

**Selecting Learning Resources**

For additional information on selecting learning resources for Grade 11 and Grade 12 Chemistry, see the Manitoba Education website at <[www.edu.gov.mb.ca/k12/learnres/bibliographies.html](http://www.edu.gov.mb.ca/k12/learnres/bibliographies.html)>.



# TOPIC 6:

# ELECTROCHEMISTRY

## APPENDICES

---

Appendix 6.1: Activity Series: Lab Activity 3

Appendix 6.2: Table of Standard Reduction Potentials 5



## Appendix 6.1: Activity Series: Lab Activity

### Purpose

In this qualitative lab activity, you will place drops of solutions onto strips of different metals and observe any reactions that occur. Each solution will have an aqueous ion that matches one of the metal strips.

### Materials

- 19 mm × 125 mm strips of aluminum (Al), copper (Cu), iron (Fe), zinc (Zn), and/or other metals
- 0.2 mol/L solutions of  $\text{Al}(\text{NO}_3)_3$ ,  $\text{Cu}(\text{NO}_3)_2$ ,  $\text{Fe}(\text{NO}_3)_3$ ,  $\text{Zn}(\text{NO}_3)_2$ , and/or other nitrates with cation species matching any other metals you may be using (e.g., Pb(s) and  $\text{Pb}(\text{NO}_3)_2$ )—Students will be using 15 to 20 drops of each solution, so 50 to 100 mL should be enough for several groups.
- eyedroppers, dropper bottles, or dropper pipettes
- steel wool or sandpaper
- pencils
- water bottle
- paper towels

### Caution:

- The chemicals used in this lab activity are oxidizers and should be handled carefully.
- All lab participants must wear personal safety equipment for protection of eyes, hands, and clothes.
- Refer to the MSDS sheets for more information on each chemical you choose to use.

### Procedures

1. Prepare 0.2 mol/L solutions of  $\text{Al}(\text{NO}_3)_3$ ,  $\text{Cu}(\text{NO}_3)_2$ ,  $\text{Fe}(\text{NO}_3)_3$ , and  $\text{Zn}(\text{NO}_3)_2$ .
2. Using steel wool or sandpaper, gently scrub approximately two-thirds of one side of the metal strips to remove oxidation, dirt, and so on. Wipe the dust into a garbage receptacle.
3. Using a pencil, draw ~7 mm circles in a row on the newly cleaned surfaces of the metal strips.
4. Place the strips on a paper towel, circles facing upward.
5. Place 2 drops of one solution on one of the circles. Wait a few seconds, and then record any observations.
6. Rinse off and dry the metal strips.
7. On a separate circle for each solution, perform the same drop test, and record observations.

## Appendix 6.1: Activity Series: Lab Activity (continued)

**Observations**

On a data table similar to the following, record observations, noting whether there was a reaction or no reaction.

Reducing Agent	Oxidizing Agent			
	$\text{Al}^{3+}_{(\text{aq})}$	$\text{Cu}^{2+}_{(\text{aq})}$	$\text{Fe}^{3+}_{(\text{aq})}$	$\text{Zn}^{2+}_{(\text{aq})}$
$\text{Al}_{(\text{s})}$				
$\text{Cu}_{(\text{s})}$				
$\text{Fe}_{(\text{s})}$				
$\text{Zn}_{(\text{s})}$				

Using the observations, complete the following:

- Write net ionic equations for each reaction that occurred. Identify the oxidizing agent, the reducing agent, what is being oxidized, and what is being reduced.
- Create a list of reduction half-reactions for each of the oxidizing agents, putting them in order from strongest to weakest oxidizer. Explain why you chose to order them in this way.

**Possible Follow-up Questions**

1. Which metal would be most likely to corrode? What leads you to believe this?
2. Zinc is used to coat objects such as nails made of iron in a process called *galvanization*. What would this accomplish?
3. Look up the electronegativities for the metals that were used. How do these electronegativities correlate to the observations? Discuss whether or not they should correlate.
4. Devise a way in which you could determine, experimentally, the oxidation numbers for the substances given to you.



## Appendix 6.2: Table of Standard Reduction Potentials

Greatest Affinity for Electrons	↑	Half-Reaction	E (volts)	↓	Weakest Reducing Agent
		$F_{2(g)} + 2e^- \rightarrow 2F_{(aq)}^-$	+2.87		
		$H_2O_{2(aq)} + 2H_{(aq)}^+ + 2e^- \rightarrow 2H_2O_{(l)}$	+1.77		
		$MnO_{4(aq)} + 8H_{(aq)}^+ + 5e^- \rightarrow Mn^{2+}_{(aq)} + 4H_2O_{(l)}$	+1.52		
		$Au_{(aq)}^{3+} + 3e^- \rightarrow Au_{(s)}$	+1.50		
		$Cl_{2(g)} + 2e^- \rightarrow 2Cl_{(aq)}^-$	+1.36		
		$Cr_2O_7^{2-}_{(aq)} + 14H_{(aq)}^+ + 6e^- \rightarrow 2Cr^{3+}_{(aq)} + 7H_2O_{(l)}$	+1.33		
		$MnO_{2(s)} + 4H_{(aq)}^+ + 2e^- \rightarrow Mn^{2+}_{(aq)} + 2H_2O_{(l)}$	+1.28		
		$1/2O_{2(g)} + 2H_{(aq)}^+ + 2e^- \rightarrow H_2O_{(l)}$	+1.23		
		$Br_{2(l)} + 2e^- \rightarrow 2Br_{(aq)}^-$	+1.06		
		$AuCl_{4(aq)}^- + 3e^- \rightarrow Au_{(s)} + 4Cl_{(aq)}^-$	+1.00		
		$NO_3^-(aq) + 4H_{(aq)}^+ + 3e^- \rightarrow NO_{(g)} + 2H_2O_{(l)}$	+0.96		
		$Ag_{(aq)}^+ + e^- \rightarrow Ag_{(s)}$	+0.80		
		$1/2Hg_{2(aq)}^{2+} + e^- \rightarrow Hg_{(l)}$	+0.79		
		$Hg_{(aq)}^{2+} + 2e^- \rightarrow Hg_{(l)}$	+0.78		
		$NO_3^-(aq) + 2H_{(aq)}^+ + e^- \rightarrow NO_{2(g)} + H_2O_{(l)}$	+0.78		
		$Fe_{(aq)}^{3+} + e^- \rightarrow Fe_{(aq)}^{2+}$	+0.77		
		$O_{2(g)} + 2H_{(aq)}^+ + 2e^- \rightarrow H_2O_{2(aq)}$	+0.68		
		$I_{2(s)} + 2e^- \rightarrow 2I_{(aq)}^-$	+0.53		
		$Cu_{(aq)}^+ + e^- \rightarrow Cu_{(s)}$	+0.52		
		$Cu_{(aq)}^{2+} + 2e^- \rightarrow Cu_{(s)}$	+0.34		
		$SO_4^{2-}(aq) + 4H_{(aq)}^+ + 2e^- \rightarrow SO_{2(g)} + 2H_2O_{(l)}$	+0.17		
		$Cu_{(aq)}^{2+} + e^- \rightarrow Cu_{(aq)}^+$	+0.15		
		$Sn_{(aq)}^{4+} + 2e^- \rightarrow Sn_{(aq)}^{2+}$	+0.15		
		$S_{(s)} + 2H_{(aq)}^+ + 2e^- \rightarrow H_2S_{(g)}$	+0.14		
		$2H_{(aq)}^+ + 2e^- \rightarrow H_{2(g)}$	0.00		
		$Pb_{(aq)}^{2+} + 2e^- \rightarrow Pb_{(s)}$	-0.13		
		$Sn_{(aq)}^{2+} + 2e^- \rightarrow Sn_{(s)}$	-0.14		
		$Ni_{(aq)}^{2+} + 2e^- \rightarrow Ni_{(s)}$	-0.25		
		$Co_{(aq)}^{2+} + 2e^- \rightarrow Co_{(s)}$	-0.28		
		$Se_{(s)} + 2H_{(aq)}^+ + 2e^- \rightarrow H_2Se_{(g)}$	-0.40		
		$Cr_{(aq)}^{3+} + e^- \rightarrow Cr_{(aq)}^{2+}$	-0.41		
		$Fe_{(aq)}^{2+} + 2e^- \rightarrow Fe_{(s)}$	-0.44		
		$Ag_2S_{(s)} + 2e^- \rightarrow 2Ag_{(s)} + S_{(aq)}^{2-}$	-0.69		
		$Te_{(s)} + 2H_{(aq)}^+ + 2e^- \rightarrow H_2Te_{(g)}$	-0.72		
		$Cr_{(aq)}^{3+} + 3e^- \rightarrow Cr_{(s)}$	-0.74		
		$Zn_{(aq)}^{2+} + 2e^- \rightarrow Zn_{(s)}$	-0.76		
		$2H_2O_{(l)} + 2e^- \rightarrow 2OH_{(aq)}^- + H_{2(g)}$	-0.83		
		$Mn_{(aq)}^{2+} + 2e^- \rightarrow Mn_{(s)}$	-1.18		
		$Al_{(aq)}^{3+} + 3e^- \rightarrow Al_{(s)}$	-1.66		
		$Mg_{(aq)}^{2+} + 2e^- \rightarrow Mg_{(s)}$	-2.37		
		$Na_{(aq)}^+ + e^- \rightarrow Na_{(s)}$	-2.71		
		$Ca_{(aq)}^{2+} + 2e^- \rightarrow Ca_{(s)}$	-2.87		
		$Sr_{(aq)}^{2+} + 2e^- \rightarrow Sr_{(s)}$	-2.89		
		$Ba_{(aq)}^{2+} + 2e^- \rightarrow Ba_{(s)}$	-2.90		
		$Cs_{(aq)}^+ + e^- \rightarrow Cs_{(s)}$	-2.92		
		$K_{(aq)}^+ + e^- \rightarrow K_{(s)}$	-2.92		
		$Rb_{(aq)}^+ + e^- \rightarrow Rb_{(s)}$	-2.92		
		$Li_{(aq)}^+ + e^- \rightarrow Li_{(s)}$	-3.00		
					↓
					Most Easily Oxidized
					Strongest Reducing Agent
Least Affinity for Electrons					
Least Easily Reduced					
Weakest Oxidizing Agent					



# GENERAL APPENDICES

---

Appendix 7: Scientific Communication 3

Appendix 8: Research 11

Appendix 9: Assessment 17

Appendix 10: Developing Assessment Rubrics in Science 23

Appendix 11: Assessment Rubrics 29

Appendix 12: General and Specific Learning Outcomes 39



## Appendix 7: Scientific Communication

One of the primary skill thrusts of Grade 12 Chemistry is that of providing many opportunities for *scientific communication*. Some of these instances will mimic the behaviours, traditions, and organizational aspects of a *scientific community*. Others are intended to be more authentic and directly promote student-centred development of skills related to the unique demands of communicating scientific ideas and results effectively.

The following strategies can be used in the science classroom to communicate scientific information. For additional information about the strategies, see the following teacher resources:

- *Senior Years Science Teachers' Handbook* (Manitoba Education and Training), abbreviated as *SYSTH*
- *Senior 3 English Language Arts: A Foundation for Implementation* (Manitoba Education and Training), abbreviated as *Senior 3 ELA*

### **Audience (Adaptation for)**

Students adapt information, such as a paragraph in a textbook, for a different audience.

### **Booklet, Brochure, Pamphlet**

Students may present information they have obtained through research or investigation in the form of a booklet, brochure, or pamphlet. This medium is most effective if the information to be represented involves a series of individual steps or points, and includes diagrams or pictures. Students involved in graphic arts may consider this an effective means of communication.

### **Cartoons**

An individual scientific concept, rule (such as a safety rule), or law may be effectively communicated by a cartoon, an illustration, or a series of pictures.

### **Charts**

Information or results that show related tendencies or patterns may be presented best in an organized chart. A flow chart may allow the steps of a process to become more apparent.

### **Concept Overview Frame (See SYSTH 11.25, 11.37)**

After studying a concept, students may fill out a Concept Overview Frame. This will allow them to summarize what they have learned.

### Data Table

Data measured during the course of an investigation are often best organized in a data table. The data table should have a title, labelled rows and columns, and the correct units. It may include several trials and the average values, as well as the equations used (in variable form). The data table should be prepared before the experiment begins.

### Debates (See SYSTH 4.19)

Debates are effective in presenting divergent opinions and attitudes related to STSE issues. The debate usually draws on students' own positions on science-related social issues. Pro and con formats can be used to illustrate the main points and to create a dialectic within the debate. While the scenario is often make-believe, the debate provides a forum for personal commentary. Because students often hold debated opinions with greater personal conviction, the debate must be structured in a manner in which sensitivity to various points of view is accepted, if not agreed upon.

#### Suggested Organization of Debates

1. Select two small balanced groups of students who support divergent and opposing views on a science-related social issue.
2. Provide or have students research background information.
3. Students on each side of the issue prepare and coordinate their evidence to avoid redundant arguments.
4. Select a moderator to monitor time and response to questions.
5. Remind students to listen to and respect divergent points of view. Discourage the notion that only one viewpoint is correct.

### Demonstrations

Demonstration of a technique or a procedure is an effective way to communicate an understanding of the process.

### Diagrams

Visual communication is often more effective than a written description. Labelled diagrams may be useful for showing equipment set-ups, cycles, and so on.

### Dramatic Presentations

Many creative students enjoy dramatizing the information to be presented (such as the history of science) in the form of a skit, a role-play, a play, or a movie. Students must be prepared to research appropriate materials before constructing the dramatic presentation, as this process may be time-consuming. Care must be taken to ensure that students concentrate on the scientific concepts and knowledge, not solely on the dramatization.

## Graphing

Representing data in graphical form helps make the relationship between variables more obvious.

- When planning the graph, students need to consider scale. They determine the maximum values for both axes and make the scale accordingly.
- Students label both the vertical and horizontal axes with the factors being graphed and indicate the units being used.
- If the points indicate a straight line, students may use a straight edge. If a line of best fit is required and calculated on the calculator, students need to represent their calculations accurately.
- In a sentence or two below the graph or within the analysis, students explain the implications or main point revealed by the representation.

## Historical Perspectives

Students communicate information from the perspective of an individual (scientist, layperson) in another time period. They may choose to write an article critiquing an idea that was controversial in its time (such as smallpox vaccination or the Earth's orbit). Students research information and reflect on their response. Variations include responding from a different age or cultural perspective.

## Inquiry or Research Paper Handbook (See Senior 3 ELA 4-270)

Working in groups, students produce a handbook outlining the various stages, processes, and strategies of the inquiry or research process. This handbook is then available as a reference during the course of study, and may be adapted or supplemented as required.

## Journals

A scientific journal is an effective way for students to record thoughts and ideas during the progression of learning. Teachers may ask students to reflect on and respond to particular questions, such as noting their thoughts on a current issue in the newspaper. Alternatively, students may record their thoughts and feelings as they read a certain piece of scientific literature.

## Learning Logs

Students keep an inquiry or research log throughout their inquiry or research project. In this log, students may collect various artifacts representing stages in the research process, as well as record anecdotes of the experience.

## Models

Students may create two- or three-dimensional models of a particular concept, theory, or idea. This may involve the use of materials such as papier mâché or modelling clay.

### **Multimedia Presentations**

Students may choose to communicate their understanding through the use of PowerPoint software, a video, or other types of electronic media.

### **Newspaper Articles**

By writing as reporters from a particular period of a society's history, students may see different perspectives of a scientific issue or idea.

### **Oral Presentations**

Gaining ease, composure, and a public presence while speaking to an audience are skills developed over many years of schooling and extracurricular activity. At certain points in a student's experience, some growth is encouraged in the arena of public oracy. When oral presentations are compulsory for students, teachers are encouraged to exercise caution and discretion. Focusing on these situations as celebrations of learning that students have mastered promotes confidence and success in addressing peers publicly.

### **Posters**

The poster session at scientific meetings has long been a standard in scientific communication, and provides an alternative venue for the presentation of new results to the large-scale public lecture that is not able to engage at a personal level. In a poster presentation, there is ample opportunity to "get close" to the creators of the work, ask questions, point out interesting facets of their work, and offer suggestions for continued efforts.

### **Presentation Software**

Students may use presentation software, such as *PowerPoint*, to present their information. Students must determine which sounds and images are suitable, and enhance communication, as well as learn how to use the program's elements to unify their presentation.

### **RAFT (Role-Audience-Format-Topic and Strong Verb) (See SYSTH 13.23 for Format)**

The RAFT writing assignment is a portfolio strategy designed to produce creative and imaginative writing pieces in science. Through these assignments, students can

- see alternative perspectives on a science topic or issue
- uncover divergent applications of science concepts
- make connections between their world of experience and their science learning (e.g., metaphorical stories)



**Recommendation Report (See Senior 3 ELA 4-270)**

Students write a short reflection on the implications of their inquiry findings. In their reflections, students may wish to

- identify subsequent inquiry topics that might grow out of the one they have researched
- suggest how the information gathered in the inquiry could be applied
- recommend action that should be taken to solve a problem
- explore how public awareness could be raised about an issue
- describe how they will think or act differently because of the inquiry

**Role-Playing (See SYSTH 4.18)**

Role-playing scenarios teach selected social processes that govern relations, such as negotiation, bargaining, compromise, and sensitivity. Ultimately, students would use these skills as they move from vision to action in dealing with STSE issues. Role-playing often provides an avenue for presenting biased opinions, which may or may not agree with the opinions of students. Most importantly, it introduces divergent points of view and allows students to analyze and respond, thereby giving them an opportunity to gain an appreciation for why individuals hold divergent points of view. Ideally, the role-playing scenario fosters critical-thinking skills while promoting tolerance of other world views. All simulations have rules that govern human interaction. Regardless of the roles assumed, certain behaviours should be promoted, while others should not be allowed.

**Roundtable**

A roundtable discussion should engage all students in open scientific discussion. The discussion may be initiated by concepts outlined in a scientific article. The opening question should engage all participants and should be based on the text of the article. Although it is not necessary, the teacher may ask *each* student to respond briefly to the first question to “break the ice.” (Examples of opening questions are: “What is the most important idea in this text? Why?” and “Do you think this text is scientifically valid? Why?”) The core question may be changed during the roundtable discussion to clarify a response or to refocus the group. This question should be focused more directly on the text. (For example: “Why did the scientists use [this animal, technique, equipment]?” or “Explain what the author meant by the word \_\_\_\_\_ in Paragraph 4.”) This question should encourage students to examine how their thinking has changed during the course of the roundtable discussion. The teacher may want to ask questions (such as “How have your answers to the opening question changed?” or “How does the topic relate to your lives?” or “What could be done next?” or “What would you change?”). These questions should not solicit answers to which everyone would agree.

- **Role of Teacher:** The teacher’s role is to facilitate, not validate. Try not to make any response, whether with a facial expression, nod, or frown, that would indicate a right or wrong answer. Ask questions that provoke and take thought to a new level. Remind students to back up thoughts with facts from the document. An idea might be to diagram the seating arrangement, “web” the

responses, and add a word or phrase beside the name of the speaker. This strategy can help

- identify who speaks and how often
- provide cues to additional questions
- keep the teacher from physically affirming responses

If one student appears to monopolize the roundtable, each student may be issued five chips. Each time the student speaks, he or she gives up a chip. Therefore, the student has five opportunities to speak.

- **Role of Student:** Student participation (both speaking and listening) is mandatory. Students need to be courteous and respectful of classmates. They speak without raising their hands, talk to each other, and address the person they are speaking to by name. A roundtable is a way for students to communicate what they think about the document, not what they feel. They should always refer to the text.

### **Scientific Paper (See SYSTH 14.13 for Format)**

At the Senior Years, exposure to the writing of a technical, scientific “paper” is of utmost importance, but it should be treated in an introductory manner. Many students face the reading (or writing) of the scientific paper rather suddenly at the post-secondary level of study, and are ill-prepared for it. In reality, particular scientific journals have their own writing style, format, and so on. No single format or referencing style should be advocated exclusively, but exposure to a few examples is helpful (for instance, using an American Psychological Association [APA] style of referencing versus numerical endnotes).

In the *Senior Years Science Teachers' Handbook*, teachers are offered some standard, normative samples of the Laboratory Report Format and the Scientific Paper Format (see SYSTH, Chapter 14: Technical Writing in Science, 14.11 to 14.15). Keep in mind that one of the chief purposes of the classical scientific paper is to announce the results of research related to *new contributions* in a field. Consequently, its role and purposes are distinct from that of a research or position paper.

### **Storyboard**

Students could create storyboards to show the development of a scientific concept or theory. Discussion may then centre on the suggestion: “What might have happened if the order of occurrence had been changed?” (changing chronology)

### **Web Page Creation (See Senior 3 ELA 4-168)**

Stages of creating a website may include

- surveying other websites on the same subject
- compiling a list of criteria for an effective website on the chosen subject
- writing a proposal for the website, describing its intended audience and purpose
- using a flow chart for constructing a personal website or contributing to the school's website

**Word Cycle, Word Glossary (See SYSTH 10.21)**

A Word Cycle is considered a Level 1 strategy in building a scientific vocabulary (for instance, see *SYSTH*, Chapter 10: Building a Scientific Vocabulary). The value in using a Word Cycle comes from taking a broad concept such as an ecosystem, providing a list of terms that could be related to that concept, and then asking students to link these words coherently. Students then learn how terminologies are related, broaden meaning of terms, and promote collaboration. Teachers are encouraged to use Word Cycle activities with their students in a cooperative manner (e.g., pairings).

A Word Glossary, steadily accumulated over time, is a useful way for students to organize the large number of terms that science topics bring forth. Pay close attention to the repetitive use of prefixes (e.g., neuro-) and suffixes (e.g., -logical) in scientific parlance.

**Written Lab Report (See SYSTH 11.38, 11.39, 14.12)**

There are a variety of formats for lab reports within a common framework. A lab report may contain the following information:

- **Abstract/Introduction:** A condensed version of the entire paper, placed at the beginning of the report. The material in the abstract is written in the same order as it appears within the paper, and should include a sentence or two summarizing the highlights from each section. The abstract is written once the paper is complete.
- **Purpose/Objective/Problem:** A brief statement of the purpose or objective of the experiment.
- **Background Information:** Information drawn from research.
- **Pre-Lab Theory:** The posing of a theoretical solution to the problem before the experimental procedure. It may involve a conceptual explanation and mathematical calculations.
- **Hypothesis:** Contrary to the persistent myth, a hypothesis is not an “educated guess” about what will happen. A statement such as “cigarette smoking causes cancer” is a hypothesis because it is a statement of suggested behaviour in the material world that is *testable* by scientific means. A hypothesis intends to make a *contingent claim* based on prior accepted models about how the world works. The claim, then, is subject to testing over and over again. It is the task of the investigation procedure either to support or to nullify the hypothesis statement.
- **Variables:** For the purposes of this curriculum, anything that comes in different types or different amounts and could possibly enter into an investigation. The simplest sort of relationship to examine is that between two variables (e.g., a person’s height and arm span). It is not always a simple task, however, to *control* all the variables that may confound a scientific investigation.
- **Materials:** A list of the materials to be used in the experiment and a labelled diagram of equipment set-up, if applicable.

- **Procedure:** Written step-by-step directions for performing the experiment and regulating the controls, and a summary of the steps taken, so that someone who has not performed this lab would be able to repeat it. If a mixture is heated, the temperature should be given. Any modifications to the procedure should be noted. When following a procedure from a secondary source, reference should be given for the source.
- **Results:** Include drawings, measurements, averages (if applicable), observations, data tables, calculations, and graphs.
- **Observations:** Qualitative interpretations of what is occurring during the course of an experiment. Examples include colour changes, odour, formation of a precipitate, release of gas, temperature differences, pressure changes, or changes in solubility.
- **Quantitative Data:** Measurements taken directly from laboratory instruments. Data must be collected with care during the experiment, properly identified, and the correct numerical values and units used. Suspected faulty data must be presented and explained in the conclusions if not used in the analysis.
- **Sample Problems:** Show the conversion of data into results. Calculations should be properly labelled, with the accuracy and precision of the instruments taken into consideration, and the correct number of significant figures used.
- **Analysis:** An important part of the report that demonstrates an understanding of the experiment. It contains an interpretation or explanation of results, indicating their significance, how accurate the original hypothesis was, sources of error and their effect on results. The analysis also indicates ways to improve the experiment, including modifying the procedure, the equipment, the variables, and so on. The analysis can relate results to the real world and may describe a follow-up or auxiliary experiment.
- **Conclusions:** A summary of results and whether the purpose of the experiment has been achieved. Readers often read the conclusion first.

### **Zines** (See Senior 3 ELA 4-166)

Zines (or fanzines, or mini-magazines) usually treat a particular theme. Components may include

- cartoon
- collage
- editorial
- interview
- memoir
- poem
- review
- survey results

## Appendix 8: Research

Learning through student-directed or student-initiated projects is known to be a highly effective pathway to promote individualized instruction or to make the best use of the diversity within the classroom. The inquiry approach advocated in Grade 12 Chemistry presupposes that students will have ample opportunity to develop and refine their research skills through gathering, filtering, processing, and evaluating scientific information.

The following learning strategies can be used in the science classroom to help students develop research skills and strategies. For additional information about the strategies, see the following teacher resources:

- *Senior Years Science Teachers' Handbook* (Manitoba Education and Training), abbreviated as *SYSTH*
- *Senior 3 English Language Arts: A Foundation for Implementation* (Manitoba Education and Training), abbreviated as *Senior 3 ELA*

### Action Plan (See *Senior 3 ELA 4-216* for Whole-Class Inquiry)

Students may submit action plans for group inquiries that include the following components.

Group Inquiry Action Plan					
Objectives	Strategies	Responsibilities	Timelines	Results	Resources

### Concept Maps (See *SYSTH 9.6, 11.7, 11.8, 11.11*)

A Concept Map is intended to help students identify key vocabulary for a topic or identify the relationships between terms in a topic. The teacher may model this procedure by arranging pieces of paper with key terms to show the relationships or logical connections between them. Concept Maps may follow a category, a chain, or a hierarchy as an organizational strategy.

### Email

The teacher can arrange links with schools, universities, or other research facilities in other parts of Canada or the world to have students carry out parallel research and to share and discuss data through email.

### Interviews (See *Senior 3 ELA 4-240, 4-226*)

Students may analyze models of interviews and practise with peers before conducting interviews in the community. It may be useful to have a preliminary interview in which students introduce themselves, describe the topic and purpose, ask the interviewee what information or experience he or she is able to relate on the

topic, explain how the interview will be conducted and how the information will be used, and discuss the time, length, and place of the interview.

### Literature-Based Research Projects (See SYSTH 4.7)

A literature-based research approach can be applied to many STSE topics. A series of questions can direct students during their topic research. Students with competent literature research skills will be able to

- locate and analyze the validity of scientific information
- reduce unnecessary duplication of laboratory investigations
- recognize multiple perspectives from various interest groups
- determine how decisions are made at the local, provincial, and federal levels of government
- examine scientific, environmental, technological, societal, and economic sides of an issue

Teachers should model the five stages of effective research: planning, information retrieval or gathering, information processing, information sharing, and evaluation.

### Plagiarism (Avoidance of) (See Senior 3 ELA 4-260)\*

Teachers use direct instruction to teach students the conventions for summarizing, paraphrasing, and quoting from research materials. To avoid plagiarism, students need opportunities for supervised practice in using secondary sources appropriately in their research.

#### Three Ways to Use Secondary Sources (Student Handout)

- **Summaries:** Summarize general information as you proceed with your research. General information consists of facts and concepts that are generally known and that appear in several sources. If you cannot judge whether information is generally known or is the property of one writer, you need to read several more sources. When you write your own text, synthesize the facts and concepts from these summaries in your own words. This information does not need to be referenced.
- **Paraphrases:** Paraphrase ideas and statements that belong to one writer, but that you do not wish to quote. To paraphrase, restate the ideas in a passage in your own words. You may need to use common words that appeared in the original, but do not repeat striking words or unique phrases that can be recognized as the style of the original writer. Reference the source of this material. It is considered good style to name the original writer in your paraphrase (e.g., Eldon Craig argues that the hog-nosed snake is a newcomer to Manitoba prairies.).
- **Quotations:** Quote striking or powerful lines that would lose their impact if they were paraphrased. Take care to quote lines accurately, and ensure that you do not lose or change their meaning by taking them out of their original context. Make arguments in your own words, and support them with a quotation rather than using quotations to make key arguments. Name the speaker or writer you are quoting, enclose the quoted material in quotation marks, and reference the source of the quotation.

\* Source: Manitoba Education and Training. *Senior 3 English Language Arts: A Foundation for Implementation*. Winnipeg, MB: Manitoba Education and Training, 1999. Adapted from Section 4, p. 260.

A form such as the following can help students distinguish between material cited directly and their own paraphrases, summaries, and comments.

<b>Form for Recording Information</b>	
Author's name: (last) _____ (first) _____ Title of source: _____ Place of publication: _____ Publisher: _____ Year of publication: _____	
<p><b>Summaries:</b> Briefly note the main ideas of the whole text.</p>	<p><b>Paraphrases:</b> Write important and supporting information in your own words. Record the page number(s).</p>
<p><b>Comments:</b> Record your own responses to questions about what you read.</p>	<p><b>Direct Quotations:</b> Record only passages that you are very likely to quote in your final article. Record the page number(s).</p>

**Proposals (See Senior 3 ELA 4-221)**

Students may submit proposals for major group projects. Depending on the project, the proposal may include the following categories:

- Purpose
- Audience
- Outline
- Resources
- Team Members and Their Responsibilities
- Steps in Research
- Risk Factors and Plans for Addressing Them
- Form for Reporting
- Timelines
- Progress Reports
- Criteria for Success

**Reading Scientific Information (See SYSTH, Chapter 12)**

Chapter 12 of *SYSTH* presents strategies to help students acquire the skills they need to comprehend science texts and scientific information accessed from multimedia sources. Students use interactive and collaborative strategies to understand and learn the content.

Good readers begin by skimming and analyzing a text and providing themselves with a structural and conceptual framework into which new information might fit. They then read for detail, with three levels of comprehension: literal understanding, interpretation, and application.

Students will be able to become better readers if teachers divide reading exercises into three sections:

- **Pre-reading:** Pre-reading strategies are intended to establish a purpose or focus, to activate prior knowledge, to emphasize new terms and vocabulary, or to provide familiarity with text features.
- **During-reading:** During-reading strategies are meant to promote collaboration, to help students recognize text structure, or to promote questioning and paraphrasing.
- **Post-reading:** Post-reading strategies are designed to teach students how to apply content by increasing comprehension and recall, connecting details to the big picture, making new connections, applying ideas, and transferring knowledge.

Various strategies are developed in *SYSTH*.



**Surveys and Questionnaires** (See Senior 3 ELA 4-226, Appendix C)

Students may submit a proposal for a survey or questionnaire in which they describe

- type of information they wish to gather
- type of survey they intend to implement
- target group and plan for random sampling
- how and when they will pilot the survey
- how and when they will administer the survey
- how they will analyze, interpret, and report data

Surveys are a useful tool for collecting information, particularly on timely, community-based inquiry topics. The following should be considered when designing and conducting a survey:

- Purpose
- Appropriateness
- Practicality
- Clarity
- Reliability
- Target Group
- Sample
- Random Selection

Types of surveys include fixed-response questions (multiple choice, agree-disagree, checklists), rating scales (numerical, categorical), open-ended, and phenomenological (extended interview). Students may choose to pilot their survey before administering it.

**WebQuest**

A WebQuest is an inquiry-oriented activity in which most or all of the information used by learners is drawn from the Web. WebQuests are designed to make efficient use of time, to focus on using information rather than looking for it, and to support learners' thinking at the levels of analysis, synthesis, and evaluation.

A basic WebQuest design includes an introduction, a task, a set of information sources needed to complete the task (not all sources need to be web-based), a description of the process in clear steps, guidance (such as guiding questions, timelines, Concept Maps), and a conclusion. WebQuest design information, templates, and samples may be obtained at WebQuest.org <<http://webquest.org/index.php>>.

## NOTES

## Appendix 9: Assessment

---

For the purpose of this curriculum, assessment is the systematic process of gathering information about what a student knows, is able to do, and is currently *learning to do*. Science education today, therefore, demands a broad range and variety of assessment tools to gauge student learning. An inclusive classroom will encourage, whenever possible, assessment opportunities that provide *all students* with the chance to demonstrate what they know *most of the time*.

This appendix provides an overview of various assessment perspectives intended to promote fair assessment and evaluation and increase students' role and responsibility in their own ongoing assessment. Some actual assessment instruments that are proving to be effective in today's classrooms are also included.

Teachers are encouraged to review the *Senior Years Science Teachers' Handbook* (see *SYSTH*, Chapter 15: Assessing and Evaluating Science Learning). Further information is also provided in *Senior 3 English Language Arts: A Foundation for Implementation* (Manitoba Education and Training), abbreviated as *Senior 3 ELA* on the following pages.

### **Concept Relationship Frame (See SYSTH 11.20, 11.25, 11.35)**

This differentiated instruction technique is designed to help students examine particular, detailed associations between two concepts (i.e., cause/effect, problem/solution, either/or, compare/contrast). The aim is to avoid superficial analysis by probing for deeper associations. Chapter 11: Developing Science Concepts Using Graphic Displays in *SYSTH* demonstrates how the Concept Relationship Frame can be used effectively.

### **Developing Assessment Rubrics in Science (See Appendix 10)**

Appendix 10 outlines various ways in which students can be engaged with their teachers in the development of assessment rubrics. It addresses questions such as the following:

- What are assessment rubrics?
- Why do teachers use assessment rubrics?
- How can assessment rubrics enhance instruction?
- What are some sources of rubrics? Sources include classroom-developed, teacher-developed, and externally developed rubrics.

**Journal Writing and Assessment (See SYSTH 13.21)**

Journal writing is a *writing to learn* strategy that engenders mixed feelings among students. Part of the “uncertainty” comes from the inability to be passive about one’s learning if one is asked to comment upon it, write carefully about it, or be reflective about it. Journals should have an *informal*, familiar tone but should not be quaint or dismissive. Journal entries can be simple and short, vary in frequency, and be structured to a particular format or free-form. It is valuable to consider how best to use journal writing in the science classroom, but experience shows that overuse defeats the purposes of the journal. For instance, if journal writing has little or no assessment/evaluation potential toward a student’s grade, or does not provide a means of obtaining teacher feedback, it is difficult to sustain a successful experience.

Establishing a dialogue with students is an important element of formative assessment. Teachers may respond to students’ journal entries, extending student thinking through comments and questions. In assessing journal entries, teachers may look for different interpretations and consideration of different perspectives, analyses, and growth.

**Laboratory Report Assessment (See Appendix 11)**

The Lab Report Assessment rubric is designed for both self-assessment and teacher assessment, and includes criteria such as the following:

- Formulates Testable Questions
- Formulates a Prediction and/or Hypothesis
- Creates a Plan
- Conducts a Fair Test and Records Observations
- Interprets and Evaluates Results
- Draws a Conclusion
- Makes Connections

**Observation Checklist: Scientific Inquiry—Conducting a Fair Test  
(See Appendix 11)**

This rubric is designed with five performance criteria, and can be used for an entire class list. The emphasis is on gathering information over time through observation. The criteria include the following:

- Demonstrating Safe Work Habits
- Ensuring Accuracy and Reliability
- Observing and Recording
- Following a Plan
- Showing Evidence of Perseverance and/or Confidence

**Peer Assessment (See Senior 3 ELA 4-307)**

Peer conferences could be organized to allow peers to act as problem solvers who offer concrete suggestions. The teacher may choose to provide students with questions and prompts. For instance, if students are editing a research paper, the peer assessment may include the following questions:

- Does the text contain enough information?
  - Pose questions that are not answered.
  - Mark passages that require more information.
- Is the text well organized?
  - Use arrows to show suggested reordering of paragraphs.
  - Mark places where a transition is required.
- Is the text clear?
  - Mark passages that are clear.
  - Mark words or phrases that need to be explained or defined.
  - Mark passages that need charts, graphs, diagrams, or examples.
- Is the information communicated in an interesting way?
  - Mark the least and most interesting sections.
- Are the sources referenced?
  - Mark un-referenced information.
  - Suggest other sources that may be used.

**Performance Assessment**

Performance assessment may take the form of

- demonstrating a lab technique (e.g., lighting a Bunsen burner, using a balance, focusing a microscope)
- demonstrating a safety procedure
- interpreting Workplace Hazardous Materials Information System (WHMIS) labels
- identifying an unknown

**Portfolios (See Senior 3 ELA 4-180)**

Portfolio items that allow students to demonstrate attainment of specific learning outcomes include

- inquiry logs
- project proposals
- webs and maps
- samples of notes
- reports on primary research
- reflective pieces

**Reading Scientific Information (Concept Map Evaluation) (See SYSTH 12.15 to 12.19)**

Chapter 12: Reading Scientific Information of *SYSTH* suggests techniques for comprehending science texts. It includes examples of how students could take notes from text in the manner of a detailed Concept Map organizer (see 12.16) and how this strategy can connect to *reading for meaning*. Once teachers have effectively modelled the techniques and students have had ample time to practise with scientific reading skills and note-taking, some criteria can be established that can be used in evaluation (see 12.19).

**References**

Students hand in a preliminary list of references as part of their proposal for a research paper.

**Rubric for Assessment of Class Presentation (See Appendix 11)**

This rubric is designed with four performance levels, and includes assessment criteria such as the following:

- Content
- Interest and Enthusiasm
- Clarity and Organization of Materials
- Use of Visual Aids

**Rubric for Assessment of Research Project (See Appendix 11)**

This rubric is designed with four performance levels, and includes criteria such as the following:

- Source of Information
- Information Collected
- Organization of Material
- Presentation of Material

**Rubric for Assessment of Scientific Inquiry (See Appendix 11)**

This rubric is designed for guidance of student assessment in relation to the performance of *scientific inquiry tasks*. The rubric is not intended to be comprehensive, but seeks to provide some project-management parameters for teachers who are observing their students' initial attempts at sophisticated investigation work.

The rubric is designed around four levels of competency, as continua, and includes criteria in the following areas:

- Development of a Position Statement (Proto-Abstract)
- Objective/Purpose/Testable Question
- Procedure (design of the investigation)
- Data Collection
- Analysis and Interpretation of Results
- Application/Discussion of Scientific Results and Concepts
- Independence Factors (measuring degree of reliance upon outside assistance)

### **Self-Assessment**

Self-assessment by students is integral to the overall assessment of learning. To assess their own work, however, students require some detailed advance knowledge (e.g., criteria) of what the expectations are. More advanced learners in this self-reflection process can then participate in setting criteria with their teacher(s). Teachers are encouraged to model self-assessment before expecting students to assess themselves.

### **Word Cycle (See SYSTH 10.6 to 10.8, 10.21)**

A Word Cycle is considered a Level 1 strategy in building a scientific vocabulary (see *SYSTH*, Chapter 10: Building a Scientific Vocabulary). The value in using a Word Cycle comes from taking a broad concept such as an ecosystem, providing a list of terms that could be related to that concept, and then asking students to link these words coherently. Students then learn how terminologies are related, broaden the meaning of terms, and promote collaboration. Teachers are encouraged to use Word Cycle activities with their students in a cooperative manner (e.g., pairings).

## NOTES



## Appendix 10: Developing Assessment Rubrics in Science\*

### The Nature, Purposes, and Sources of Assessment Rubrics for Science

#### What Assessment Rubrics Are

Rubrics are assessment tools that identify criteria by which student processes, performances, or products will be assessed. They also describe the qualities of work at various levels of proficiency for each criterion.

The following types of assessment rubrics may be used in classroom assessment:

- **General rubrics** provide descriptions of proficiency levels that can be applied to a range of student processes, performances, or products. Using the same rubric for similar tasks helps teachers manage marking assignments based on student choice. It also helps students internalize the common qualities of effective processes, performances, and products.
- **Task-specific rubrics** describe the criteria used in assessing specific forms, such as using a balance, writing a laboratory report, or calibrating CBL probes. Complex student projects may require a different rubric for each phase (for example, a group inquiry project may require a rubric for collaborative work, information-gathering processes, oral presentations, and written reports).
- **Holistic rubrics** are used to assign a single mark to a process, performance, or product on the basis of its adequacy in meeting identified criteria.
- **Analytic rubrics** are used to assign individual scores to different aspects of a process, performance, or product, based on their specific strengths and weaknesses according to identified criteria. See the Rubric for Assessment of Decision-Making Process Activity in Appendix 11.
- **Checklists** are lists of criteria that do not distinguish levels of performance. They are used to assess the presence or absence of certain behaviours, and are most suitable for assessing processes (for example, “Did the student perform all the necessary steps?”). Because they require “Yes/No” judgements from the assessors, checklists are easy for students to use in peer assessment.
- **Rating scales** ask assessors to rate various elements of a process, performance, or product on a numerical scale. They do not provide complete descriptions of performance at various levels.

#### Why Teachers Use Assessment Rubrics

The best assessment tasks ask students to perform the sorts of scientific literacy tasks they will be called upon to perform in real-world situations. They allow students to demonstrate not only the declarative knowledge they have gained, but also the interplay of attitudes, skills, and strategies that constitute their learning.

---

\* Source: Manitoba Education and Training. *Senior 3 English Language Arts: A Foundation for Implementation*. Winnipeg, MB: Manitoba Education and Training, 1999. Adapted from Appendices, pp. 3–9.

Authentic assessment tasks invite a range of responses and allow students to express their individuality. For all these reasons, assessing scientific literacy is a complex matter.

Assessment rubrics

- help teachers clarify the qualities they are looking for in student work
- ensure that all students are assessed by the same criteria
- help teachers communicate the goals of each assignment in specific terms
- allow teachers within schools, school divisions, and the province to collaborate in assessment
- play an important part in instruction

### **How Assessment Rubrics Enhance Instruction**

The best assessment tools do not simply sort and score student work; instead, they describe it in specific terms. This assessment information

- helps teachers adjust instruction to meet student learning requirements
- tells students what teachers expect and will look for in their work, and helps them to focus their efforts
- allows students to assess their own work using the criteria teachers will use to set goals and to monitor their progress
- aids in the development of metacognition by giving students a vocabulary for talking about particular aspects of their work

### **Sources of Assessment Rubrics**

Teachers develop assessment rubrics in collaboration with students, on their own, and/or with other teachers, or obtain them through published sources.

- **Classroom development:** Developing assessment rubrics in collaboration with students can be a time-consuming process, but one that has many benefits in instruction and learning. (Both the benefits and the process are explored on the following pages.) Although it may not be possible to involve students in the process in every instance, their experience in developing rubrics will help students to use ready-made rubrics with more understanding.
- **Teacher-developed:** Teachers develop general performance and product rubrics individually in collaboration within a school or school division. Rubrics must be adapted regularly to reflect student performance levels accurately. It is important that teacher-developed rubrics use language that students understand, and that teachers provide an example of work at each level of proficiency. These examples (called anchors or exemplars) illustrate for students the descriptive phrases used in the rubrics.
- **Published sources:** High-quality assessment rubrics are available in various educational resources. The disadvantage of ready-made rubrics is that they may not be congruent with the learning outcomes targeted in a particular assignment, and may not accurately describe Grade 12 performance levels and criteria.

## Developing Rubrics in Collaboration with Students

### Student Benefits

Developing rubrics in collaboration with students requires them to look at work samples, and to identify the attributes that make some samples successful and others unsuccessful. Teachers assist students by providing them with the vocabulary to articulate the various elements they see, and by ensuring that the criteria are comprehensive and consistent with learning outcomes. This collaborative process in developing rubrics

- requires students to make judgements about the work they see, and to identify the qualities of effective writing, speaking, and representing of science concepts
- results in an assessment tool that students understand and feel they own—they see that assessment criteria are not arbitrary or imposed, but rather express their own observations about what constitutes quality work

### The Development Process

For their first experience in designing a rubric, ask students to articulate the criteria they use in making judgements about something in everyday life—the quality of a restaurant, for example. The model rubric that they develop for assessing restaurants may help students grasp how the parts of a rubric work.

Students may also find it helpful to develop rubrics after they have done some preliminary work on the assessment task, and so are familiar with the demands of the particular assignment.

The process of developing assessment rubrics in collaboration with students involves numerous steps.

#### *1. Look at student work samples.*

Develop assessment rubrics by analyzing genuine samples of student work that illustrate the learning outcomes that the assessment task in question addresses. Samples are usually drawn from student work from previous years, used with permission and with names removed. Beginning teachers who do not have files of samples may need to borrow from colleagues.

Select samples that are clear and characteristic of student work at various levels. Streamline the process by distributing examples at only three levels of proficiency: excellent, adequate, and inadequate. Provide two or three examples of each level. Allow students time to read the examples and to talk about them in groups.

#### *2. Describe the work samples.*

Suggest that students focus on the examples of excellent work first. Pose the question: “What makes this piece successful?” Then ask students to brainstorm attributes of, or criteria for, success. Some of the attributes students list will describe behaviours that are useful in meeting the goals of the work (for example, the topic is stated at the beginning, there are few spelling errors, a graph is used to represent statistical findings).

What rubrics must attempt to articulate, beyond identifying these behaviours, is the essence of a good product or performance. Eye contact may be important in the delivery of an oral report, but it is possible to give a dreary talk while maintaining eye contact (Wiggins V1-5: 6). Together with students, identify the salient qualities of works related to science that are engaging and effective. These may be qualities that are harder to define and illustrate (for example, the speaker has moved beyond a superficial understanding of the subject, the producer of a video is aware of the audience, the writer's voice is discernible in a science journalism piece).

### 3. *Develop criteria categories.*

From the brainstormed list of attributes, select the criteria categories that will make up the assessment rubric. Most rubrics are limited to three to five criteria categories. A greater number makes the rubrics difficult for assessors to use, especially in assessing live performances. Listing too many criteria can also overwhelm or confuse students who use the rubrics for self-assessment and setting goals.

Develop criteria categories by combining related attributes and selecting three to five that are considered most important. Label the criteria categories in general terms (organization, style, content) and expand them by listing the specific elements to be examined in assessing quality in these criteria (for example, in the "organization" category, the elements may be statement of purpose, topic sentences, transition words and phrases, paragraph breaks, order of ideas).

Ensure that no essential attribute that defines good performance is left out. This means including elements considered hard to assess (such as style or creativity). Ignoring elements such as these signals that they are not important. Addressing them helps students grasp the things they can do to improve their own work in these areas. If graphical analysis is identified as one criteria category, for example, the rubric may list elements that convey the details of such an analysis (for example, placement of dependent and independent variables, placement of data points, line of "best fit"). It may also provide definitions.

As students collaborate to develop criteria categories, monitor whether the criteria chosen are related to the intended learning outcomes.

### 4. *Decide how many performance levels the rubric will contain.*

The first rubric students develop should have three performance levels, based on identifying student work samples as excellent, adequate, or inadequate. In later rubrics, students may move to finer distinctions between levels. The number of levels needed to make meaningful judgements regarding the full range of proficiency is best decided by the teacher. If the scale is large (seven levels, for example), finer distinctions can be made, but it may be difficult to differentiate clearly one level from the next. In science, assessment rubrics designed to be

used by students as well as teachers generally use three, four, or five performance levels.\*

Using the same number of performance levels for various tasks throughout the curriculum has the advantage of giving students and the teacher a common vocabulary in talking about ways to improve performance (for example, “This piece does not have the concrete detail of level 4 writing.”). Once the number of criteria categories and performance levels has been determined, a rubric template such as the following can be used in developing rubrics.

		Criteria Categories			
Performance Levels	1				
	2				
	3				
	4				
	5				

5. *Describe the performance levels.*

In developing the assessment criteria (step 3), students analyze successful pieces of work. They now fill in descriptions of excellent, adequate, and inadequate performance in all criteria categories.

There are two ways of describing performance levels:

- **Evaluative rubrics** use comparative adjectives (for example, “weak organization”).
- **Descriptive rubrics** specify the qualities of work at each performance level with respect to the criteria (for example, “unconnected ideas appear in the same paragraph”). The attributes listed may be negative (for example, “subscripts and coefficients are incorrectly applied”), for sometimes the most telling characteristic of certain levels is their failure to do what they should be doing.

Descriptive rubrics have many advantages over evaluative rubrics. They are more helpful to students because they spell out the behaviours and qualities students encounter in assessing their own and others’ work. They also help students identify the things they can address in their own work in order to improve.

---

\* Many designers of rubrics advocate a five-level scale. Levels 1, 3, and 5 are developed from an initial sorting of student work into excellent, adequate, and inadequate samples. Levels 2 and 4 describe work that is between these anchor points. Other educators argue that an even-point scale (four or six levels) forces more care in judging than an odd number does; it prevents assessors from overusing a middle category for work that is difficult to assess.

When beginning to write descriptive rubrics, students may suggest generally descriptive adjectives (such as “interesting,” “boring”), which may not convey information about what an interesting piece looks like, and how they can improve their work in this area. The description needs to state the attributes that make a work interesting, and should be written in an acceptable style for scientific communication. Classes may need to begin by using comparative language or general descriptions. As the students and teacher collect examples, they can fine-tune the rubric with specific descriptions.

By the end of this step, students will have a description of performance at three levels. If the class has decided to create a rubric with four, five, or six performance levels, it may be most efficient for the teacher to draft gradations of quality for the middle levels, and present them to the class for revision. These middle levels are the most difficult to write, and call on more experience and expertise in developing a smooth continuum of proficiency.

**6. *Use the assessment rubric for student self-assessment, for teacher assessment, and for instruction.***

Before using the rubric on an actual assignment, students and the teacher may want to test it against unsorted samples of work from previous years. Applying the rubric to student work helps the class determine whether the rubric accurately describes the qualities of the work they see, and helps students make meaningful distinctions between work at different levels of proficiency. As students become more adept at using the rubric, and when they have internalized the performance levels, the teacher can present them with more diverse samples and assessment challenges.

Rubrics make it possible for students to assess their own work on the basis of the criteria that the teacher will use. Any differences in scores between a student’s and a teacher’s assessment can be the subject of profitable and focused discussion in student conferences.

If numerical scores are required, point values assigned to each level can be totalled. If the teacher and students decide that certain criteria categories should be more heavily weighted than others, the points assigned to these categories can be multiplied by a factor.

A rubric developed collaboratively can also become a valuable instructional tool, encouraging students to look closely at the specific things they can do to improve a piece of work. If students decide that a writing sample in science is at level 3, for example, they can be asked to work together in groups to improve the work so that it fits the description for level 4.

**7. *Continue to revise the assessment rubric.***

Any assessment rubric can be considered a work in progress, especially if it is stored on the computer. Both the teacher and students should carefully review the rubric each time they use it, asking, “Do these criteria capture the most important qualities of excellence in this work?” “What other words and phrases can we use to describe work at this level?” In keeping with this, the rubrics appearing in Appendix 11 of this document are intended as templates, open to situational revisions.

## Appendix 11: Assessment Rubrics

### Rubric for Assessment of Research Project

Student Name(s) \_\_\_\_\_ Topic/Title \_\_\_\_\_

Criteria	Performance Levels			
	Level 1	Level 2	Level 3	Level 4
Source of Information	<input type="checkbox"/> Only one source of information was used.	<input type="checkbox"/> Two sources of information were used.	<input type="checkbox"/> A variety of sources was used.	<input type="checkbox"/> A wide variety of sources was used in a unique manner.
Information Collected	<input type="checkbox"/> The information collected was not relevant.	<input type="checkbox"/> The information collected was relevant to the topic but was not blended into a cohesive piece of research.	<input type="checkbox"/> The information collected was relevant to the topic and was somewhat organized into a cohesive piece of research.	<input type="checkbox"/> The information collected was relevant to the topic and was carefully organized into a cohesive piece of research.
Organization of Material	<input type="checkbox"/> The information collected was not organized.	<input type="checkbox"/> The information was somewhat organized.	<input type="checkbox"/> The information was organized and contained recognizable sections.	<input type="checkbox"/> The information was organized and contained recognizable sections that included an introduction, a main body with supporting evidence, and a conclusion that summarized the report.
Presentation of Material	<input type="checkbox"/> The report was handwritten, contrary to established guidelines.	<input type="checkbox"/> The report was neatly handwritten. <input type="checkbox"/> The report contained a bibliography that was not correctly formatted.	<input type="checkbox"/> The report was typed. <input type="checkbox"/> The report contained graphics. <input type="checkbox"/> The report contained a bibliography that was not correctly formatted.	<input type="checkbox"/> The report was typed and appropriately formatted. <input type="checkbox"/> The report contained a title page. <input type="checkbox"/> The report contained relevant graphics. <input type="checkbox"/> The report contained a complete, correctly formatted bibliography.

*Note: This rubric would vary, depending on the assignment and the presentation format.*

### Rubric for Assessment of Decision-Making Process Activity

Student Name(s) \_\_\_\_\_ Topic/Title \_\_\_\_\_

Criteria	Performance Levels			
	Level 1	Level 2	Level 3	Level 4
Identifies STSE Issue	<ul style="list-style-type: none"> <li><input type="checkbox"/> Cannot identify an STSE issue without assistance.</li> </ul>	<ul style="list-style-type: none"> <li><input type="checkbox"/> Shows a basic understanding that an issue could have STSE implications, but does not necessarily differentiate among the areas.</li> </ul>	<ul style="list-style-type: none"> <li><input type="checkbox"/> Shows a good understanding of a connection between an issue and its STSE applications.</li> <li><input type="checkbox"/> Shows some awareness of the need for an individual response.</li> </ul>	<ul style="list-style-type: none"> <li><input type="checkbox"/> Demonstrates excellent depth and sensitivity in connecting an issue with its STSE implications.</li> <li><input type="checkbox"/> Demonstrates a level of social responsibility.</li> </ul>
Evaluates Current Research on Issue	<ul style="list-style-type: none"> <li><input type="checkbox"/> Is able to access a small amount of current research but does not evaluate it.</li> </ul>	<ul style="list-style-type: none"> <li><input type="checkbox"/> Demonstrates some ability to recognize the positions taken in the research data but makes no clear evaluative statements.</li> </ul>	<ul style="list-style-type: none"> <li><input type="checkbox"/> Secures an array of research, narrow in its scope, but clearly identifies the positions taken.</li> <li><input type="checkbox"/> Can offer personal opinions on issue but not necessarily an evaluation.</li> </ul>	<ul style="list-style-type: none"> <li><input type="checkbox"/> Acquires research that is current, relevant, and from a variety of perspectives.</li> <li><input type="checkbox"/> Demonstrates insight into the stated positions and can frame an evaluation.</li> </ul>
Formulates Possible Options	<ul style="list-style-type: none"> <li><input type="checkbox"/> Is unable to identify the possible options clearly.</li> <li><input type="checkbox"/> Can formulate options that are not clearly connected to the problem to be solved.</li> </ul>	<ul style="list-style-type: none"> <li><input type="checkbox"/> Offers at least one feasible option that is connected to the problem.</li> <li><input type="checkbox"/> Offers other options that may be somewhat related to the problem.</li> </ul>	<ul style="list-style-type: none"> <li><input type="checkbox"/> Develops at least two feasible options that are internally consistent and directly address the problem.</li> <li><input type="checkbox"/> Recognizes that some options will fail.</li> </ul>	<ul style="list-style-type: none"> <li><input type="checkbox"/> Displays a sophisticated understanding of feasible options that is beyond expectations.</li> <li><input type="checkbox"/> Presents choice of options that demonstrate a reasonable chance of succeeding.</li> </ul>
Identifies Projected Impacts	<ul style="list-style-type: none"> <li><input type="checkbox"/> Is unable to foresee the possible consequences of the options selected.</li> <li><input type="checkbox"/> Appears to have a naive awareness of consequences.</li> </ul>	<ul style="list-style-type: none"> <li><input type="checkbox"/> Identifies potential impacts of decisions taken in a vague or insubstantial way.</li> <li><input type="checkbox"/> Views most of the feasible options as having projected impacts.</li> </ul>	<ul style="list-style-type: none"> <li><input type="checkbox"/> Identifies potential impacts of decisions taken in an organized way.</li> <li><input type="checkbox"/> Views all the feasible options as having projected impacts: some beneficial, some not.</li> </ul>	<ul style="list-style-type: none"> <li><input type="checkbox"/> Offers a cost/benefits/risks analysis of each feasible solution.</li> <li><input type="checkbox"/> Constructs an organized report that clearly outlines the impacts of each option.</li> </ul>

(continued)







## Lab Report Assessment

Project Title \_\_\_\_\_ Date \_\_\_\_\_

Team Members \_\_\_\_\_

Area of Interest	Possible Points	Self	Teacher
<p><b>Formulates Testable Questions:</b> Question is testable and focused, and the cause-and-effect relationship is identified.</p>			
<p><b>Formulates a Prediction/Hypothesis:</b> Independent and dependent variables are identified and the prediction/hypothesis clearly identifies a cause-and-effect relationship between these two variables.</p>			
<p><b>Creates a Plan:</b> All steps are included and clearly described in a logical sequence. All required materials/equipment are identified. Safety considerations are addressed. Major intervening variables are controlled.</p>			
<p><b>Conducts a Fair Test and Records Observations:</b> Evidence of repeated trials is presented and all data are included. Detailed data are recorded, and appropriate units are used. Data are recorded in a clear/well-structured/appropriate format for later reference.</p>			
<p><b>Interprets and Evaluates Results:</b> Patterns/trends/discrepancies are identified. Strengths and weaknesses of approach and potential sources of error are identified. Changes to the original plan are identified and justified.</p>			
<p><b>Draws a Conclusion:</b> Conclusion explains cause-and-effect relationship between dependent and independent variables. Alternative explanations are identified. Hypothesis is supported or rejected.</p>			
<p><b>Makes Connections:</b> Potential applications are identified and/or links to area of study are made.</p>			
<p><b>Total Points</b></p>			

## Rubric for Assessment of Student Presentation

Student Name(s) _____ Topic/Title _____		Performance Levels			
		Level 1	Level 2	Level 3	Level 4
<b>Criteria</b>					
<b>Organization</b>	<input type="checkbox"/> Presentation shows poor organization and lack of preparation. <input type="checkbox"/> Some student preparation is shown.	<input type="checkbox"/> Presentation shows signs of organization, but some parts do not seem to fit the topic. <input type="checkbox"/> A fair amount of student preparation is shown.	<input type="checkbox"/> Presentation is organized, logical, and interesting. <input type="checkbox"/> An adequate amount of student preparation is shown.	<input type="checkbox"/> Presentation is well organized, logical, interesting, and lively. <input type="checkbox"/> A great deal of student preparation is shown.	
<b>Preparation</b>	<input type="checkbox"/> Small amount of material presented is related to the topic.	<input type="checkbox"/> Some material presented is not related to the topic.	<input type="checkbox"/> Almost all material presented is related to the topic.	<input type="checkbox"/> All material presented is related to the topic.	
<b>Language</b>	<input type="checkbox"/> Language used is hard to follow and understand.	<input type="checkbox"/> Some language used is hard to follow and understand.	<input type="checkbox"/> Most language used is easy to follow and understand.	<input type="checkbox"/> Language used is well chosen and is easy to follow and understand.	
<b>Format</b>	<input type="checkbox"/> Poor use of aids and support materials (diagrams, overheads, maps, pictures); few support the topic.	<input type="checkbox"/> Adequate use of aids and support materials; most support the topic.	<input type="checkbox"/> Good use of aids and support materials; almost all support the topic.	<input type="checkbox"/> Excellent use of aids and support materials; all aids support the topic.	
<b>Delivery</b>	<input type="checkbox"/> Many words are unclear or spoken too quickly or slowly; voice is monotonous; no pausing for emphasis; voice is too low to be heard easily.	<input type="checkbox"/> Some words are unclear or spoken too quickly at times; voice is somewhat varied; some pausing for emphasis; voice is sometimes too low to be heard easily.	<input type="checkbox"/> Most words are clear and generally spoken at the correct speed; voice is often varied and interesting; frequent pausing for emphasis; voice is loud enough to be heard easily.	<input type="checkbox"/> Words are clear and generally spoken at the correct speed; voice is frequently varied and interesting; effective pausing for emphasis; voice is loud enough to be heard easily.	
<b>Audience</b>	<input type="checkbox"/> Audience is not involved or interested.	<input type="checkbox"/> Audience is somewhat involved, and sometimes interested.	<input type="checkbox"/> Audience is involved and interested.	<input type="checkbox"/> Audience is very involved and interested.	

**Note:** The above criteria are suggestions only, and will need to be adapted in collaboration with students according to the purpose of the assignment.

## Rubric for Assessment of Class Presentation

Student Name(s) _____	Topic/Title _____			
<b>Criteria</b>	<b>Performance Levels</b>			
	<b>Level 1</b>	<b>Level 2</b>	<b>Level 3</b>	<b>Level 4</b>
<b>Content</b>	<input type="checkbox"/> No understanding of the topic was evident.  <input type="checkbox"/> Presenter(s) displayed little interest in and enthusiasm for the topic of the presentation. <input type="checkbox"/> The class conveyed limited attentiveness during the presentation.	<input type="checkbox"/> Basic understanding of the topic was evident. <input type="checkbox"/> No attempt was made to relate material presented to students' own experiences.  <input type="checkbox"/> Presenter(s) showed some interest in and enthusiasm for the topic. <input type="checkbox"/> The class showed some attentiveness during the presentation.	<input type="checkbox"/> Good understanding of the topic was evident. <input type="checkbox"/> Knowledge was thorough and detailed. <input type="checkbox"/> Attempt was made to relate material presented to students' own experiences.	<input type="checkbox"/> Excellent depth of understanding was evident. <input type="checkbox"/> Material presented went beyond what was required. Excellent research. <input type="checkbox"/> Material presented related to students' own experiences.
<b>Interest and Enthusiasm</b>	<input type="checkbox"/> Presenter(s) displayed little interest in and enthusiasm for the topic of the presentation. <input type="checkbox"/> The class conveyed limited attentiveness during the presentation.	<input type="checkbox"/> Presenter(s) showed some interest in and enthusiasm for the topic. <input type="checkbox"/> The class showed some attentiveness during the presentation.	<input type="checkbox"/> Presenter(s) clearly showed interest in and enthusiasm for the topic. <input type="checkbox"/> The class was noticeably attentive during the presentation.	<input type="checkbox"/> Presenter(s) showed exceptional interest in and enthusiasm for the topic. <input type="checkbox"/> The class was keenly attentive during the presentation.
<b>Clarity and Organization of Material</b>	<input type="checkbox"/> The information presented was confusing.	<input type="checkbox"/> The information presented was somewhat vague. <input type="checkbox"/> The presentation reflected some organization.	<input type="checkbox"/> The information was clearly presented. <input type="checkbox"/> The presentation was well organized.	<input type="checkbox"/> All information was relevant and clearly presented. <input type="checkbox"/> The presentation was exceptionally well organized. <input type="checkbox"/> Main points were emphasized and reinforced with appropriate examples.
<b>Use of Visual Aids</b>	<input type="checkbox"/> Visual aids were not used.	<input type="checkbox"/> A few visual aids were used. <input type="checkbox"/> Visual aids were not well done. <input type="checkbox"/> Visual aids used were somewhat relevant to the presentation.	<input type="checkbox"/> Visual aids were used. <input type="checkbox"/> Visual aids were quite well done. <input type="checkbox"/> Visual aids were relevant to the presentation.	<input type="checkbox"/> Strong visual aids were used with care. <input type="checkbox"/> Visual aids were clear and exceptionally well done, showing effective use of colour. <input type="checkbox"/> Visual aids were designed to emphasize and strengthen the presentation and were successful.

**Note:** This rubric would vary according to the assignment and the presentation format.

## Rubric for Assessment of Research Skills

Research Skills	Performance Levels			
	Level 1	Level 2	Level 3	Level 4
Ability to formulate questions to identify problems for research purposes	<input type="checkbox"/> Shows limited ability	<input type="checkbox"/> Shows some ability	<input type="checkbox"/> Shows general ability	<input type="checkbox"/> Shows consistent and thorough ability
Ability to locate relevant primary and secondary sources of information	<input type="checkbox"/> Unable to locate	<input type="checkbox"/> Somewhat able to locate	<input type="checkbox"/> Generally able to locate	<input type="checkbox"/> Always or almost always able to locate
Ability to locate and record relevant information from a variety of sources	<input type="checkbox"/> Unable to locate and record	<input type="checkbox"/> Somewhat able to locate and record	<input type="checkbox"/> Generally able to locate and record	<input type="checkbox"/> Always or almost always able to locate and record
Ability to organize information related to identified problem(s)	<input type="checkbox"/> Shows limited ability	<input type="checkbox"/> Shows some ability	<input type="checkbox"/> Shows general ability	<input type="checkbox"/> Shows consistent and thorough ability
Ability to analyze and synthesize information related to identified problems	<input type="checkbox"/> Shows limited ability	<input type="checkbox"/> Shows some ability	<input type="checkbox"/> Shows general ability	<input type="checkbox"/> Shows consistent and thorough ability
Ability to communicate results of inquiries using a variety of appropriate presentation forms (oral, media, written, graphic, pictorial, other)	<input type="checkbox"/> Unable to communicate	<input type="checkbox"/> Somewhat able to communicate	<input type="checkbox"/> Generally able to communicate	<input type="checkbox"/> Always or almost always able to communicate

**Note:** This rubric would vary according to the assignment and the presentation format.

## Rubric for Assessment of Scientific Inquiry

Student Name(s) \_\_\_\_\_ Topic/Title \_\_\_\_\_

Criteria	Performance Levels			
	Beginning 1	Developing 2	Accomplished 3	Exemplary 4
<b>Position Statement/ Proto-Abstract</b> (Not intended to be an abstract in the style and purpose of scientific journals)	The student <input type="checkbox"/> does not discuss the relevance of the inquiry	The student <input type="checkbox"/> offers some discussion but no clear explanation of the importance or goals of the inquiry	The student <input type="checkbox"/> discusses the importance of the inquiry but not its relationship to the curriculum or to the real world	The student <input type="checkbox"/> clearly summarizes the inquiry, highlights relevant information, and makes critical connections
<b>Objective/Purpose/ Testable Question</b> (Formulation of scientific questions and hypotheses)	<input type="checkbox"/> omits an objective/purpose, or states an objective not relevant to the problem under investigation	<input type="checkbox"/> states an objective that is not a hypothesis or a testable question, but identifies variables to be investigated	<input type="checkbox"/> states a testable question related to the problem, and identifies variables to be investigated	<input type="checkbox"/> clearly states a testable hypothesis that addresses the problem, and clearly delineates the variables to be tested
<b>Procedure</b> (Design of the investigation)	<input type="checkbox"/> does not outline reproducible steps in the procedure <input type="checkbox"/> shows some use of methodology, but no account of experimental or systematic error	<input type="checkbox"/> outlines clear, ordered steps in the procedure <input type="checkbox"/> identifies need for treatment of variables, but does not state how this will be achieved	<input type="checkbox"/> outlines clear, ordered steps in the procedure <input type="checkbox"/> identifies need for treatment of <i>specific</i> variables, and states how this will be achieved	<input type="checkbox"/> outlines clear, ordered steps in the procedure <input type="checkbox"/> identifies need for treatment of <i>specific</i> variables, and states how this will be achieved <input type="checkbox"/> provides a concise summary of the procedure
<b>Data Collection</b>	<input type="checkbox"/> collects some data that can be traced to the investigation itself, but data are inaccurate and incomplete	<input type="checkbox"/> provides reasonably complete data, organized in tabular form (+/- titles) <input type="checkbox"/> gives no indication of use of basic accuracy and precision techniques (e.g., significant figures)	<input type="checkbox"/> provides complete data, organized in tabular form (+/- titles) <input type="checkbox"/> demonstrates some use of basic accuracy and precision techniques (e.g., significant figures)	<input type="checkbox"/> provides complete data with error analysis, organized in tabular form (+/- titles) <input type="checkbox"/> demonstrates use of basic accuracy and precision techniques (e.g., significant figures)

(continued)

## Rubric for Assessment of Scientific Inquiry (continued)

		Performance Levels			
		Beginning 1	Developing 2	Accomplished 3	Exemplary 4
<b>Criteria</b>	Topic/Title _____				
<b>Analysis and Interpretation of Results</b>		<ul style="list-style-type: none"> <li><input type="checkbox"/> provides improper, incomplete graphical representation of data</li> <li><input type="checkbox"/> attempts no "fit" for plotted data</li> <li><input type="checkbox"/> requires abundance of supervision</li> </ul>	<ul style="list-style-type: none"> <li><input type="checkbox"/> provides proper graphical representation of data</li> <li><input type="checkbox"/> attempts to fit a <i>linear</i> regression line to data</li> <li><input type="checkbox"/> ensures axes are labelled correctly and positioned consistently with identified variables</li> </ul>	<ul style="list-style-type: none"> <li><input type="checkbox"/> provides proper graphical representation of data in a variety of forms</li> <li><input type="checkbox"/> shows evidence of mastery in fitting a <i>non-linear</i> regression line to data, and states <i>slope</i> and <i>y-intercept</i></li> <li><input type="checkbox"/> ensures axes are labelled correctly and positioned consistently with identified variables</li> <li><input type="checkbox"/> demonstrates understanding of how variables relate to a model equation</li> </ul>	
<b>Application/ Discussion of Scientific Results and Concepts</b>		<ul style="list-style-type: none"> <li><input type="checkbox"/> attempts to explain inquiry results in terms of random error alone ("where I went wrong")</li> <li><input type="checkbox"/> makes inaccurate, improper, or no conclusions based on data</li> </ul>	<ul style="list-style-type: none"> <li><input type="checkbox"/> attempts to connect inquiry results with model systems encountered in class experience</li> <li><input type="checkbox"/> identifies where systematic error may have caused problems</li> </ul>	<ul style="list-style-type: none"> <li><input type="checkbox"/> draws accurate and detailed comparison between the system under investigation and what could occur in an ideal system</li> <li><input type="checkbox"/> makes use of introductory statistical analyses</li> <li><input type="checkbox"/> identifies "outliers" in data set(s)</li> </ul>	
<b>Independence Factors</b> (Reliance on assistance)		<ul style="list-style-type: none"> <li><input type="checkbox"/> requires extensive assistance from text sources and classmates to do inquiry tasks</li> <li><input type="checkbox"/> requires constant teacher supervision</li> </ul>	<ul style="list-style-type: none"> <li><input type="checkbox"/> requires little assistance to complete inquiry tasks</li> <li><input type="checkbox"/> is able to internalize teacher intervention, and work independently afterward</li> </ul>	<ul style="list-style-type: none"> <li><input type="checkbox"/> requires no assistance to complete inquiry tasks</li> <li><input type="checkbox"/> demonstrates cooperation with partners</li> <li><input type="checkbox"/> resists efforts of others to assist</li> </ul>	<ul style="list-style-type: none"> <li><input type="checkbox"/> requires no assistance to complete inquiry tasks</li> <li><input type="checkbox"/> demonstrates cooperation with partners</li> <li><input type="checkbox"/> seeks opportunities to discuss procedures and results with others</li> </ul>



---

## Appendix 12: General and Specific Learning Outcomes

---

### General Learning Outcomes

General learning outcomes (GLOs) provide connections to the Five Foundations for Science Literacy that guide all Manitoba science curricula in all science discipline areas.

#### Nature of Science and Technology

As a result of their Senior Years science education, students will:

- A1** Recognize both the power and limitations of science as a way of answering questions about the world and explaining natural phenomena.
  - A2** Recognize that scientific knowledge is based on evidence, models, and explanations, and evolves as new evidence appears and new conceptualizations develop.
  - A3** Distinguish critically between science and technology in terms of their respective contexts, goals, methods, products, and values.
  - A4** Identify and appreciate contributions made by women and men from many societies and cultural backgrounds that have increased our understanding of the world and brought about technological innovations.
  - A5** Recognize that science and technology interact with and advance one another.
- 

#### Science, Technology, Society, and the Environment (STSE)

As a result of their Senior Years science education, students will:

- B1** Describe scientific and technological developments – past and present – and appreciate their impact on individuals, societies, and the environment, both locally and globally.
  - B2** Recognize that scientific and technological endeavours have been and continue to be influenced by human needs and the societal context of the time.
  - B3** Identify the factors that affect health, and explain the relationships among personal habits, lifestyle choices, and human health, both individual and social.
  - B4** Demonstrate knowledge of and personal consideration for a range of possible science- and technology-related interests, hobbies, and careers.
  - B5** Identify and demonstrate actions that promote a sustainable environment, society, and economy, both locally and globally.
-

### **Scientific and Technological Skills and Attitudes**

As a result of their Senior Years science education, students will:

- C1** Recognize safety symbols and practices related to scientific and technological activities and to their daily lives, and apply this knowledge in appropriate situations.
  - C2** Demonstrate appropriate scientific inquiry skills when seeking answers to questions.
  - C3** Demonstrate appropriate problem-solving skills when seeking solutions to technological challenges.
  - C4** Demonstrate appropriate critical thinking and decision-making skills when choosing a course of action based on scientific and technological information.
  - C5** Demonstrate curiosity, skepticism, creativity, open-mindedness, accuracy, precision, honesty, and persistence, and appreciate their importance as scientific and technological habits of mind.
  - C6** Employ effective communication skills and use information technology to gather and share scientific and technological ideas and data.
  - C7** Work cooperatively and value the ideas and contributions of others while carrying out scientific and technological activities.
  - C8** Evaluate, from a scientific perspective, information and ideas encountered during investigations and in daily life.
- 

### **Essential Science Knowledge**

As a result of their Senior Years science education, students will:

- D1** Understand essential life structures and processes pertaining to a wide variety of organisms, including humans.
  - D2** Understand various biotic and abiotic components of ecosystems, as well as their interaction and interdependence within ecosystems and within the biosphere as a whole.
  - D3** Understand the properties and structures of matter, as well as various common manifestations and applications of the actions and interactions of matter.
  - D4** Understand how stability, motion, forces, and energy transfers and transformations play a role in a wide range of natural and constructed contexts.
  - D5** Understand the composition of the Earth's atmosphere, hydrosphere, and lithosphere, as well as the processes involved within and among them.
  - D6** Understand the composition of the universe, the interactions within it, and the implications of humankind's continued attempts to understand and explore it.
-

## Unifying Concepts

As a result of their Senior Years science education, students will:

- E1** Describe and appreciate the similarity and diversity of forms, functions, and patterns within the natural and constructed world.
  - E2** Describe and appreciate how the natural and constructed world is made up of systems and how interactions take place within and among these systems.
  - E3** Recognize that characteristics of materials and systems can remain constant or change over time, and describe the conditions and processes involved.
  - E4** Recognize that energy, whether transmitted or transformed, is the driving force of both movement and change, and is inherent within materials and in the interactions among them.
- 

## Cluster 0: Skills and Attitudes

Cluster 0 in Grade 12 Chemistry comprises four categories of specific learning outcomes that describe the skills and attitudes involved in scientific inquiry and the decision-making process for science, technology, society, and the environment (STSE) issues. From Grades 5 to 10, students develop scientific inquiry through the development of a hypothesis/prediction, the identification and treatment of variables, and the formation of conclusions. Students begin to make decisions based on scientific facts and refine their decision-making skills as they progress through the grades, gradually becoming more independent. Students also develop key attitudes, an initial awareness of the nature of science, and other skills related to research, communication, the use of information technology, and cooperative learning.

In Grade 12 Chemistry, students continue to use scientific inquiry as an important process in their science learning, but also recognize that STSE issues require a more sophisticated treatment through the decision-making process.

Teachers should select appropriate contexts to introduce and reinforce scientific inquiry, the decision-making process, and positive attitudes within the thematic topics (Topics 1 to 6) throughout the school year. To assist in planning and to facilitate curricular integration, many specific learning outcomes within the Skills and Attitudes cluster can link to specific learning outcomes in other subject areas.

### Demonstrating Understanding

**C12-0-U1** Use appropriate strategies and skills to develop an understanding of chemical concepts.

*Examples: analogies, concept frames, concept maps, manipulatives, particulate representations, role-plays, simulations, sort-and-predict frames, word cycles . . .*

**C12-0-U2** Demonstrate an understanding of chemical concepts.

*Examples: use accurate scientific vocabulary, explain concepts to others, compare and contrast concepts, apply knowledge to new situations and/or contexts, create analogies, use manipulatives . . .*

---

### Scientific Inquiry

- C12-0-S1** Demonstrate work habits that ensure personal safety and the safety of others, as well as consideration for the environment.  
Include: knowledge and use of relevant safety precautions, Workplace Hazardous Materials Information System (WHMIS), and emergency equipment
- C12-0-S2** State a testable hypothesis or prediction based on background data or on observed events.
- C12-0-S3** Design and implement an investigation to answer a specific scientific question.  
Include: materials, independent and dependent variables, controls, methods, and safety considerations
- C12-0-S4** Select and use scientific equipment appropriately and safely.  
*Examples: volumetric glassware, balance, thermometer . . .*
- C12-0-S5** Collect, record, organize, and display data using an appropriate format.  
*Examples: labelled diagrams, graphs, multimedia applications, software integration, probeware . . .*
- C12-0-S6** Estimate and measure accurately using Système International (SI) and other standard units.  
Include: SI conversions and significant figures
- C12-0-S7** Interpret patterns and trends in data, and infer and explain relationships.
- C12-0-S8** Evaluate data and data-collection methods for accuracy and precision.  
Include: discrepancies in data, sources of error, and percent error
- C12-0-S9** Draw a conclusion based on the analysis and interpretation of data.  
Include: cause-and-effect relationships, alternative explanations, and supporting or rejecting a hypothesis or prediction
- 

### Research

- C12-0-R1** Synthesize information obtained from a variety of sources.  
Include: print and electronic sources, specialists, and other resource people
- C12-0-R2** Evaluate information obtained to determine its usefulness for information needs.  
*Examples: scientific accuracy, reliability, currency, relevance, balance of perspectives, bias . . .*
- C12-0-R3** Quote from or refer to sources as required and reference information sources according to an accepted practice.
- C12-0-R4** Compare diverse perspectives and interpretations in the media and other information sources.
- C12-0-R5** Communicate information in a variety of forms appropriate to the audience, purpose, and context.
-

**Communication and Teamwork**

- C12-0-C1** Collaborate with others to achieve group goals and responsibilities.
- C12-0-C2** Elicit, clarify, and respond to questions, ideas, and diverse points of view in discussions.
- C12-0-C3** Evaluate individual and group processes.
- 

**Nature of Science**

- C12-0-N1** Explain the roles of theory, evidence, and models in the development of scientific knowledge.
- C12-0-N2** Describe, from a historical perspective, how the observations and experimental work of many individuals led to modern understandings of matter.
- C12-0-N3** Describe how scientific knowledge changes as new evidence emerges and/or new ideas and interpretations are advanced.
- 

**STSE**

- C12-0-T1** Describe examples of the relationship between chemical principles and applications of chemistry.
- C12-0-T2** Explain how scientific research and technology interact in the production and distribution of beneficial materials.
- C12-0-T3** Provide examples of how chemical principles are applied in products and processes, in scientific studies, and in daily life.
- 

**Attitudes**

- C12-0-A1** Demonstrate confidence in their ability to carry out investigations in chemistry and to address STSE-related issues.
- C12-0-A2** Value skepticism, honesty, accuracy, precision, perseverance, and open-mindedness as scientific and technological habits of mind.
- C12-0-A3** Demonstrate a continuing, increasingly informed interest in chemistry and chemistry-related careers and issues.
- C12-0-A4** Be sensitive and responsible in maintaining a balance between the needs of humans and a sustainable environment.
-

## Specific Learning Outcomes

The specific learning outcomes (SLOs) identified here constitute the intended learning to be achieved by the student by the end of Grade 12 Chemistry. These statements clearly define what students are expected to achieve and/or be able to perform at the end of course. These SLOs, combined with the Skills and Attitudes SLOs, constitute the source upon which assessment and instructional design are based.

### Topic 1: Reactions in Aqueous Solutions (18 hours)

- C12-1-01** Explain examples of solubility and precipitation at the particulate and symbolic levels.
- C12-1-02** Perform a laboratory activity to develop a set of solubility rules.
- C12-1-03** Use a table of solubility rules to predict the formation of a precipitate.
- C12-1-04** Write balanced neutralization reactions involving strong acids and bases.
- C12-1-05** Perform a laboratory activity to demonstrate the stoichiometry of a neutralization reaction between a strong base and a strong acid.
- C12-1-06** Calculate the concentration or volume of an acid or a base from the concentration and volume of an acid or a base required for neutralization.
- C12-1-07** Design and test a procedure to determine the identity of a variety of unknown solutions.
- C12-1-08** Outline the development of scientific understanding of oxidation and reduction reactions.  
Include: gain and loss of electrons, oxidizing agent, and reducing agent
- C12-1-09** Determine the oxidation numbers for atoms in compounds and ions.
- C12-1-10** Identify reactions as redox or non-redox.  
Include: oxidizing agent, reducing agent, oxidized substance, and reduced substance
- C12-1-11** Balance oxidation-reduction reactions using redox methods.  
Include: acidic and basic solutions
- C12-1-12** Research practical applications of redox reactions.  
*Examples: rocket fuels, fireworks, household bleach, photography, metal recovery from ores, steel making, aluminum recycling, fuel cells, batteries, tarnish removal, fruit clocks, forensic blood detection using luminol, chemiluminescence/bioluminescence, electrolytic cleaning, electrodeposition, photochemical etching, antioxidants/preservatives . . .*
-

**Topic 2: Atomic Structure (10 hours)**

- C12-2-01** Describe qualitatively the electromagnetic spectrum in terms of frequency, wavelength, and energy.
- C12-2-02** Recognize, through direct observation, that elements have unique line spectra.  
Include: flame tests or gas discharge tubes and spectroscopes or diffraction gratings
- C12-2-03** Describe applications and/or natural occurrences of line spectra.  
*Examples: astronomy, aurora borealis, fireworks, neon lights . . .*
- C12-2-04** Outline the historical development of the quantum mechanical model of the atom.
- C12-2-05** Write electron configurations for elements of the periodic table.  
Include: selected elements up to atomic number 36 (krypton)
- C12-2-06** Relate the electron configuration of an element to its valence electron(s) and its position on the periodic table.
- C12-2-07** Identify and account for periodic trends among the properties of elements, and relate the properties to electron configuration.  
Include: atomic radii, ionic radii, ionization energy, and electronegativity
- 

**Topic 3: Chemical Kinetics (10 hours)**

- C12-3-01** Formulate an operational definition of *reaction rate*.  
Include: examples of chemical reactions that occur at different rates
- C12-3-02** Identify variables used to monitor reaction rates (i.e., change per unit of time,  $\Delta x / \Delta t$ ).  
*Examples: pressure, temperature, pH, conductivity, colour . . .*
- C12-3-03** Perform a laboratory activity to measure the average and instantaneous rates of a chemical reaction.  
Include: initial reaction rate
- C12-3-04** Relate the rate of formation of a product to the rate of disappearance of a reactant, given experimental rate data and reaction stoichiometry.  
Include: descriptive treatment at the particulate level
- C12-3-05** Perform a laboratory activity to identify factors that affect the rate of a chemical reaction.  
Include: nature of reactants, surface area, concentration, pressure, volume, temperature, and presence of a catalyst
- C12-3-06** Use the collision theory to explain the factors that affect the rate of chemical reactions.  
Include: activation energy and orientation of molecules
-

- C12-3-07** Draw potential energy diagrams for endothermic and exothermic reactions.  
 Include: relative rates, effect of a catalyst, and heat of reaction (enthalpy change)
- C12-3-08** Describe qualitatively the relationship between factors that affect the rate of chemical reactions and the relative rate of a reaction, using the collision theory.
- C12-3-09** Explain the concept of a reaction mechanism.  
 Include: rate-determining step
- C12-3-10** Determine the rate law and order of a chemical reaction from experimental data.  
 Include: zero-, first-, and second-order reactions and reaction rate versus concentration graphs
- 

**Topic 4: Chemical Equilibrium (17 hours)**

- C12-4-01** Relate the concept of equilibrium to physical and chemical systems.  
 Include: conditions necessary to achieve equilibrium
- C12-4-02** Write equilibrium law expressions from balanced chemical equations for heterogeneous and homogeneous systems.  
 Include: mass action expression
- C12-4-03** Use the value of the equilibrium constant ( $K_{eq}$ ) to explain how far a system at equilibrium has gone towards completion.
- C12-4-04** Solve problems involving equilibrium constants.
- C12-4-05** Perform a laboratory activity to determine the equilibrium constant of an equilibrium system.
- C12-4-06** Use Le Châtelier's principle to predict and explain shifts in equilibrium.  
 Include: temperature changes, pressure/volume changes, changes in reactant/product concentration, the addition of a catalyst, the addition of an inert gas, and the effects of various stresses on the equilibrium constant
- C12-4-07** Perform a laboratory activity to demonstrate Le Châtelier's principle.
- C12-4-08** Interpret concentration versus time graphs.  
 Include: temperature changes, concentration changes, and the addition of a catalyst
- C12-4-09** Describe practical applications of Le Châtelier's principle.  
*Examples: Haber process, hemoglobin production at high altitude, carbonated beverages, eyes adjusting to light, blood pH, recharging of batteries, turbocharged/supercharged engines, ester synthesis, weather indicators, arrangement of produce, carbonated beverages in a hen's diet . . .*
- C12-4-10** Write solubility product ( $K_{sp}$ ) expressions from balanced chemical equations for salts with low solubility.



- C12-4-11** Solve problems involving  $K_{sp}$ .  
Include: common ion problems
- C12-4-12** Describe examples of the practical applications of salts with low solubility.  
*Examples: kidney stones, limestone caverns, osteoporosis, tooth decay . . .*
- C12-4-13** Perform a laboratory activity to determine the  $K_{sp}$  of a salt with low solubility.
- 

### Topic 5: Acids and Bases (14 hours)

- C12-5-01** Outline the historical development of acid-base theories.  
Include: the Arrhenius, Brønsted-Lowry, and Lewis theories
- C12-5-02** Write balanced acid-base chemical equations.  
Include: conjugate acid-base pairs and amphoteric behaviour
- C12-5-03** Describe the relationship between the hydronium and hydroxide ion concentrations in water.  
Include: the ion product of water,  $K_w$
- C12-5-04** Perform a laboratory activity to formulate an operational definition of  $pH$ .
- C12-5-05** Describe how an acid-base indicator works in terms of colour shifts and Le Châtelier's principle.
- C12-5-06** Solve problems involving  $pH$ .
- C12-5-07** Distinguish between strong and weak acids and bases.  
Include: electrolytes and non-electrolytes
- C12-5-08** Write the equilibrium expression ( $K_a$  or  $K_b$ ) from a balanced chemical equation.
- C12-5-09** Use  $K_a$  or  $K_b$  to solve problems for  $pH$ , percent dissociation, and concentration.
- C12-5-10** Perform a laboratory activity to determine the concentration of an unknown acid or base, using a standardized acid or base.
- C12-5-11** Predict whether an aqueous solution of a given ionic compound will be acidic, basic, or neutral, given the formula.
-

**Topic 6: Electrochemistry (14 hours)**

- C12-6-01** Develop an activity series experimentally.
- C12-6-02** Predict the spontaneity of reactions using an activity series.
- C12-6-03** Outline the historical development of voltaic (galvanic) cells.  
Include: contributions of Luigi Galvani and Alessandro Volta
- C12-6-04** Explain the operation of a voltaic (galvanic) cell at the visual, particulate, and symbolic levels.  
Include: writing half-cell reactions, the overall reaction, and shorthand (line) notation
- C12-6-05** Construct a functioning voltaic (galvanic) cell and measure its potential.
- C12-6-06** Define *standard electrode potential*.  
Include: hydrogen electrode as a reference
- C12-6-07** Calculate standard cell potentials, given standard electrode potentials.
- C12-6-08** Predict the spontaneity of reactions using standard electrode potentials.
- C12-6-09** Compare and contrast voltaic (galvanic) and electrolytic cells.
- C12-6-10** Explain the operation of an electrolytic cell at the visual, particulate, and symbolic levels.  
Include: a molten ionic compound and an aqueous ionic compound
- C12-6-11** Describe practical uses of electrolytic cells.  
*Examples: electrolysis of water, electrolysis of brine, electroplating, production and purification of metals . . .*
- C12-6-12** Solve problems related to electrolytic cells, using Faraday's law.
-

# BIBLIOGRAPHY

---



## BIBLIOGRAPHY

- Alberta Education. *Integrated Occupational Program: Teacher Resource Manual, Science 8 and 9*. Edmonton, AB: Alberta Education, 1989.
- Alberta Education. *Workshop Materials*. Edmonton, AB: Alberta Education, 1989.
- Becker, Robert. "pH Rainbow Tube." *Chem 13 News* 190 (Dec. 1989): n.p. Available online at <[www.nku.edu/~sieveb1/makeandtake2011.pdf](http://www.nku.edu/~sieveb1/makeandtake2011.pdf)> (27 Aug. 2012).
- Bilash, Borislav II, George R. Gross, and John K. Koob. *A Demo a Day: A Year of Chemical Demonstrations*. Batavia, IL: Flinn Scientific, Inc., 1995.
- Black, P., and D. Wiliam. "Inside the Black Box: Raising Standards through Classroom Assessment." *Phi Delta Kappan* 80.2 (1998): 139–148.
- Bransford, John D., Ann L. Brown, and Rodney R. Cocking, eds. *How People Learn: Brain, Mind, Experience, and School*. Expanded Edition. A National Research Council Report. Washington, DC: National Academy Press, 2000.
- Bybee, Rodger W., C. Edward Buchwald, Sally Crissman, David R. Heil, Paul J. Kuerbis, Carolee Matsumoto, and Joseph P. McInerney. *Science and Technology Education for the Elementary Years: Frameworks for Curriculum and Instruction*. Rowley, MA: The National Center for Improving Science Education (The NETWORK Inc.), 1989.
- Champagne, A. B., R. F. Gunstone, and L. E. Klopfer. "Instructional Consequences of Students' Knowledge about Physical Phenomena." *Cognitive Structure and Conceptual Change*. Ed. L. H. T. West and A. L. Pines. New York, NY: Academic Press, 1985. 61–90.
- Chang, Raymond. *Chemistry*. 4th ed. Boston, MA: McGraw-Hill Higher Education, 1991.
- \_\_\_\_\_. *Chemistry*. 9th ed. Boston, MA: McGraw-Hill Higher Education, 2007.
- Chastko, Audrey, Jeff Goldie, Frank Mustoe, Ian Phillips, and Sandy Searle. *McGraw-Hill Ryerson Inquiry into Chemistry*. Toronto, ON: McGraw-Hill Ryerson, 2007.
- Clement, John. "A Conceptual Model Discussed by Galileo and Used Intuitively by Physics Students." *Mental Models*. Ed. Dedre Gentner and Albert L. Stevens. London, UK: Lawrence Erlbaum Associates, 1983.
- Corno, Lyn, and Judi Randi. "Motivation, Volition, and Collaborative Innovation in Classroom Literacy." *Reading Engagement: Motivating Readers through Integrated Sources*. Ed. John T. Guthrie and Allan Wigfield. Newark, DE: International Reading Association, 1997. 51–67.
- Cotton, F. Albert, Geoffrey Wilkinson, Carlos A. Murillo, and Manfred Bochmann. *Advanced Inorganic Chemistry*. 6th ed. New York, NY: Wiley-Interscience, 1999.

- Council of Ministers of Education, Canada. *Common Framework of Science Learning Outcomes K to 12: Pan-Canadian Protocol for Collaboration on School Curriculum*. Toronto, ON: Council of Ministers of Education, Canada, 1997.
- CRC Handbook of Chemistry and Physics: A Ready-Reference Book for Chemical and Physical Data. Cleveland, OH: CRC Press, annual publication.
- Cropper, William H. *Great Physicists: The Life and Times of Leading Physicists from Galileo to Hawking*. Oxford, UK: Oxford University Press, 2004.
- Davies, Lucille, Maurice Di Giuseppe, Ted Gibb, Milan Sanader, and Angela Vavitsas. *Nelson Chemistry 12: College Preparation*. Ontario Edition. Toronto, ON: Thomson Nelson, 2003.
- Davis, Joseph E., W. Keith McNab, Edward L. Haenisch, A. L. McClellan, and Paul R. O'Connor. *Laboratory Manual for Chemistry: Experiments and Principles*. Lexington, MA: D.C. Heath and Company, 1968.
- Dingrando, Laurel, Kathleen (Gregg) Tallman, Nichols Hainen, and Cheryl Wistrom. *Glencoe Chemistry: Matter and Change*. Columbus, OH: Glencoe/McGraw-Hill, 2005.
- \_\_\_\_\_. *Glencoe Chemistry: Matter and Change: ChemLab and MiniLab Worksheets*. Columbus, OH: Glencoe/McGraw-Hill, 2002.
- \_\_\_\_\_. *Glencoe Chemistry: Matter and Change, Laboratory Manual*. Columbus, OH: Glencoe/McGraw-Hill, 2005.
- \_\_\_\_\_. *Glencoe Chemistry: Matter and Change: Small-Scale Laboratory Manual, Teacher Edition*. Columbus, OH: Glencoe/McGraw-Hill, 2002.
- \_\_\_\_\_. *Glencoe Chemistry: Matter and Change, Teacher Wraparound Edition*. Columbus, OH: Glencoe/McGraw-Hill, 2005.
- Dorin, Henry, Peter E. Demmin, and Dorothy L. Gabel. *Prentice Hall Chemistry: The Study of Matter*. Needham, MA: Prentice Hall, Inc., 1992.
- Drake, Susan M. *Planning Integrated Curriculum: The Call to Adventure*. Alexandria, VA: Association for Supervision and Curriculum Development, 1993.
- Earl, Lorna M., Steven Katz, and Western and Northern Canadian Protocol for Collaboration in Education. *Rethinking Classroom Assessment with Purpose in Mind: Assessment for Learning, Assessment as Learning, Assessment of Learning*. Winnipeg, MB: Manitoba Education, Citizenship and Youth, 2006. Available online at <[www.edu.gov.mb.ca/k12/assess/wncp/](http://www.edu.gov.mb.ca/k12/assess/wncp/)>.
- Ehrenkranz, David F., and John J. Mauch. *Chemistry in Microscale*. Dubuque, IA: Kendall/Hunt Pub., 1993.
- Ehrenkranz, David F., and John J. Mauch. *Chemistry in Microscale: A Set of Microscale Laboratory Experiments with Teacher Guides*. 2nd ed. Kendall/Hunt Publishing, 1996.

- Ellis, Edwin S., Donald D. Deshler, B. Keith Lenz, Jean B. Shumaker, and Francis L. Clark. "An Instructional Model for Teaching Learning Strategies." *Focus on Exceptional Children* 23.6 (Feb. 1991): 1-22.
- Fischer, Robert B. *A Basic Course in the Theory and Practice of Quantitative Chemical Analysis*. 2nd ed. Philadelphia, PA: W. B. Saunders Co., 1965.
- Fisher, Douglas. *Glencoe Chemistry: Matter and Change, Science Notebook*. Columbus, OH: Glencoe/McGraw-Hill, 2005.
- Foster, Graham. *Student Self-Assessment: A Powerful Process for Helping Students Revise Their Writing*. Markham, ON: Pembroke, 1996.
- Gilbert, George, L. "Tested Demonstrations: Sodium D Line Emission from Pickle." *Journal of Chemical Education* 70.3 (Mar. 1993): 250-251.
- Glatthorn, Allan A. *Learning Twice: An Introduction to the Methods of Teaching*. New York, NY: HarperCollins College, 1993.
- Good, Thomas L., and Jero E. Brophy. *Looking in Classrooms*. New York, NY: Harper and Row, 1987.
- Gross, George, et al. "Indicator Sponge." *A Demo a Day: A Year of Chemical Demonstrations*. Ed. Borislaw Bilash II, George R. Gross, and John K. Koob. Batavia, IL: Flinn Scientific, Inc., 1995.
- Hake, R. R. "Interactive Engagement Versus Traditional Methods: A Six-Thousand-Student Survey of Mechanics Test Data for Introductory Physics Courses." *American Journal of Physics* 66.1 (1998): 64-74.
- Hammer, D. "Epistemological Considerations in Teaching Introductory Physics." *Science Education* 79.4 (1995): 393-413.
- Hestenes, David, Malcolm Wells, and Gregg Swackhamer. "Force Concept Inventory." *The Physics Teacher* 30 (1992): 141-151.
- Hewson, P. W. "Epistemological Commitments in the Learning of Science: Examples from Dynamics." *European Journal of Science Education* 7.2 (1985): 163-172.
- Hodson, Derek. "Philosophy of Science and Science Education." *Journal of Philosophy of Education* 20 (1986): 215-225.
- \_\_\_\_\_. "Toward Universal Scientific Literacy." *Science, Math and Technology Learning for All*. Special issue of *Orbit* 31.3 (2000): 13-15.
- Holmquist, Dan D., and Donald L. Volz. *Chemistry with Calculators*. Portland, OR: Vernier, 2000. Available online at <[www.vernier.com/chemistry/](http://www.vernier.com/chemistry/)>.
- Holmquist, Dan D., Jack Randall, and Donald L. Volz. *Chemistry with CBL*. Portland, OR: Vernier Software, 1997.
- \_\_\_\_\_. *Chemistry with Vernier*. Beaverton, OR: Vernier, 2007. Available online at <[www.vernier.com/products/books/cwv/](http://www.vernier.com/products/books/cwv/)>.

- Hoy, R. R. "A 'Model Minority' Speaks Out on Cultural Shyness." *Science* 262 (1993): 1117-1118.
- Jenkins, Frank, Hans van Kessel, Lucille Davies, Oliver Lantz, Patricia Thomas, and Dick Tompkins. *Nelson Chemistry 11*. Ontario Edition. Toronto, ON: Nelson Thomson Learning, 2002.
- Kolodny, A. "Colleges Must Recognize Students' Cognitive Styles and Cultural Backgrounds." *Chronicle of Higher Education* 37.21 (1991): A44.
- Kuhn, Thomas. "Objectivity, Value Judgement, and Theory Choice." *The Essential Tension: Selected Studies in Scientific Tradition and Change*. Chicago, IL: University of Chicago Press, 1977. 320-339.
- Kuhn, Thomas S. *The Structure of Scientific Revolutions*. Chicago, IL: University of Chicago Press, 1962.
- Larochelle, Marie, and Jacques Désautels. *About Science: Students' Cognitive Paths*. Laval, QC: Presse de l'université Laval, 1992.
- Larochelle, Marie, et Jacques Désautels. *Autour de l'idée de science : itinéraires cognitifs d'étudiants et d'étudiantes*. Laval, QC: Presse de l'université Laval, 1992.
- Locke, E. A., and G. P. Latham. *A Theory of Goal Setting and Task Performance*. Englewood Cliffs, NJ: Prentice Hall, 1990.
- Manitoba Education. *Grade 12 Biology: A Foundation for Implementation*. Winnipeg, MB: Manitoba Education, 2011.
- Manitoba Education and Training. *Education for a Sustainable Future: A Resource for Curriculum Developers, Teachers, and Administrators*. Winnipeg, MB: Manitoba Education and Training, 2000. Available online at [www.edu.gov.mb.ca/k12/docs/support/future/](http://www.edu.gov.mb.ca/k12/docs/support/future/).
- \_\_\_\_\_. *A Foundation for Excellence*. Winnipeg, MB: Manitoba Education and Training, 1995.
- \_\_\_\_\_. *Reporting on Student Progress and Achievement: A Policy Handbook for Teachers, Administrators, and Parents*. Winnipeg, MB: Manitoba Education and Training, 1997.
- \_\_\_\_\_. *Science Safety: A Kindergarten to Senior 4 Resource Manual for Teachers, Schools, and School Divisions*. Winnipeg, MB: Manitoba Education and Training, 1997.
- \_\_\_\_\_. *Senior 2 English Language Arts: A Foundation for Implementation*. Winnipeg, MB: Manitoba Education and Training, 1998.
- \_\_\_\_\_. *Senior 3 English Language Arts: A Foundation for Implementation*. Winnipeg, MB: Manitoba Education and Training, 1999.
- \_\_\_\_\_. *Senior 4 English Language Arts: A Foundation for Implementation*. Winnipeg, MB: Manitoba Education and Training, 2000.



- \_\_\_\_\_. *Senior Years Science Teachers' Handbook: A Teaching Resource*. Winnipeg, MB: Manitoba Education and Training, 1997.
- \_\_\_\_\_. *Success for All Learners: A Handbook on Differentiating Instruction: A Resource for Kindergarten to Senior 4*. Winnipeg, MB: Manitoba Education and Training, 1996.
- \_\_\_\_\_. *Technology As a Foundation Skill Area: A Journey Toward Information Technology Literacy: A Resource for Curriculum Developers, Teachers, and Administrators*. Winnipeg, MB: Manitoba Education and Training, 1998.
- Manitoba Education and Youth. *Senior 2 Science: A Foundation for Implementation*. Winnipeg, MB: Manitoba Education and Youth, 2003.
- Manitoba Education, Citizenship and Youth. *Communicating Student Learning: Guidelines for Schools*. Winnipeg, MB: Manitoba Education, Citizenship and Youth, 2008. Available online at [www.edu.gov.mb.ca/k12/assess/docs/csl/index.html](http://www.edu.gov.mb.ca/k12/assess/docs/csl/index.html).
- \_\_\_\_\_. *Grade 11 Chemistry: A Foundation for Implementation*. Winnipeg, MB: Manitoba Education, Citizenship and Youth, 2006. Available online at [www.edu.gov.mb.ca/k12/cur/science/scicurr.html](http://www.edu.gov.mb.ca/k12/cur/science/scicurr.html).
- \_\_\_\_\_. *Grade 11 and Grade 12 Learning Resources: A Reference for Selecting Learning Resources*. Winnipeg, MB: Manitoba Education, Citizenship and Youth, 2007.
- \_\_\_\_\_. *Senior 4 Physics: A Foundation for Implementation*. Winnipeg, MB: Manitoba Education, Citizenship and Youth, 2005. Available online at [www.edu.gov.mb.ca/k12/cur/science/scicurr.html](http://www.edu.gov.mb.ca/k12/cur/science/scicurr.html).
- Manitoba Sustainable Development Coordination Unit. *Sustainable Development Strategy for Manitoba*. Winnipeg, MB: Sustainable Development Coordination Unit, 1998.
- Maxwell, Rhoda J., and Mary J. Meiser. *Teaching English in Middle and Secondary Schools*. 2nd ed. Upper Saddle River, NJ: Prentice Hall, 1997.
- McDermott, L. C. "What We Teach and What Is Learned – Closing the Gap." *American Journal of Physics* 59.4 (1991): 301–315.
- McDermott, L. C., and E. F. Redish. "Resource Letter PER-1: Physics Education Research." *American Journal of Physics* 67 (1999): 755–767.
- McGrath, Kimberly A., ed. *World of Physics*. Vol. 1 and 2. Detroit, MI: The Gale Group, 2001.
- Merrill, Phyllis, Robert W. Parry, and Robert L. Tellefsen. *Chemistry: Experimental Foundations, Laboratory Manual*. 3rd ed. Englewood Cliffs, NJ: Prentice Hall, Inc., 1982.
- Millar, Robin, and Jonathan Osborne, eds. *Beyond 2000: Science Education for the Future*. London, UK: King's College, 1998. Available online at [www.kcl.ac.uk/content/1/c6/01/32/03/b2000.pdf](http://www.kcl.ac.uk/content/1/c6/01/32/03/b2000.pdf).

- Morrison, Duncan, and Darrel Scodellaro. *Essential Experiments for Chemistry*. Thornhill, ON: SMG Lab, 2005.
- Mustoe, Frank, Michael P. Jansen, Ted Doram, John Ivanco, Christina Clancy, and Anita Ghazariansteja. *McGraw-Hill Ryerson Chemistry*. Combined Atlantic Edition. Toronto, ON: McGraw-Hill Ryerson, 2004.
- National Academy of Sciences (NAS). *Changing Emphases in Assessment of Student Learning*. Washington, DC: National Academy Press, 1996.
- National Research Council (NRC). *National Science Education Standards*. Washington, DC: National Academy Press, 1996.
- \_\_\_\_\_. Committee on Undergraduate Science Education. *Science Teaching Reconsidered*. Washington, DC: National Academy Press, 1997.
- O'Connor, Paul R. *Laboratory Manual for Chemistry: Experiments and Principles*. Toronto, ON: Copp Clark Publishing, 1968.
- Palmquist, Bruce C. "Interactive Spectra Demonstration." *The Physics Teacher* 40.3 (Mar. 2002): 140.
- Parry, R. W. *Chemistry: Experimental Foundations*. 2nd. ed. Englewood Cliffs, NJ: Prentice-Hall, 1975.
- PASCO Scientific. *PASPort Explorations in Chemistry Lab Manual*. Roseville, CA: PASCO, n.d.
- Penrose, Mike, Ted Gibb, Milan Sanader, and Angela Vavitsas. *Nelson Chemistry 12: College Preparation Teacher's Resource*. Toronto, ON: Nelson, 2004.
- Phillips, John S., Victor S. Strozak, and Cheryl Wistrom. *Glencoe Chemistry: Concepts and Applications*. Columbus, OH: Glencoe/McGraw-Hill, 2005.
- Probst, Robert E. *Response and Analysis: Teaching Literature in Junior and Senior High School*. Don Mills, ON: Heinemann, 1988.
- Purcell-Gates, Victoria. "Process Teaching with Direct Instruction and Feedback in a University-Based Clinic." *Balanced Instruction: Strategies and Skills in Whole Language*. Ed. Ellen McIntyre and Michael Pressley. Norwood, MA: Christopher-Gordon, 1996. 107-127.
- "Reaction Tendencies." *Chemical Equilibrium*. Concepts in Science series. TVOntario. Toronto, ON. 1984. (60 min.) Video.
- Reif, F., and J. H. Larkin. "Cognition in Scientific and Everyday Domains: Comparison and Learning Implications." *Journal of Research in Science Teaching* 28 (1991): 733-760.
- Ryan, Richard M., James P. Connell, and Edward L. Deci. "A Motivational Analysis of Self-Determination and Self-Regulation in Education." *Research and Motivation in Education: The Classroom Milieu*. Ed. Russell Ames and Carole Ames. Vol. 2. New York, NY: Academia Press, 1985. 13-51.

- Saskatchewan Education. *Instructional Approaches: A Framework for Professional Practice*. Regina, SK: Saskatchewan Education, 1991.
- Schunk, Dale H., and Barry Zimmerman. "Developing Self-Efficacious Readers and Writers: The Role of the Social and Self-Regulatory Processes." *Reading Engagement: Motivating Readers through Integrated Sources*. Ed. John T. Guthrie and Allan Wigfield. Newark, DE: International Reading Association, 1997.
- Shakhashiri, Bassam Z. *Chemical Demonstrations: A Handbook for Teachers of Chemistry*. Vol. 1. Madison, WI: University of Wisconsin Press, 1983.
- \_\_\_\_\_. *Chemical Demonstrations. A Handbook for Teachers of Chemistry*. Vol. 2. Madison, WI: University of Wisconsin Press, 1985.
- \_\_\_\_\_. *Chemical Demonstrations: A Handbook for Teachers of Chemistry*. Vol. 3. Madison, WI: University of Wisconsin Press, 1989.
- \_\_\_\_\_. *Chemical Demonstrations: Handbook for Teachers of Chemistry*. Vol. 4. Madison, WI: University of Wisconsin Press, 1992.
- Shapiro, Stan. *General Level Chemistry Resource Book*. Toronto, ON: Scarborough Board of Education Program Department, 1981.
- Silberberg, Martin S. *Chemistry: The Molecular Nature of Matter and Change*. 3rd ed. Boston, MA: McGraw-Hill Higher Education, 2003.
- Slater, A., and G. Rayner-Canham. *Microscale Chemistry Laboratory Manual*. Reading, MA: Addison-Wesley Publishers Limited, 1994.
- Smith, Richard, Robert C. Smoot, and Jack Price. *Chemistry: A Modern Course*. Columbus, OH: C. E. Merrill Publishing, 1979.
- Smoot, Robert C., Jack Price, and Richard G. Smith. *Merrill Chemistry: A Modern Course*. Canadian Edition. Toronto, ON: Merrill Publishing Co., 1987.
- \_\_\_\_\_. *Merrill Chemistry: A Modern Course, Teacher Annotated Edition*. Columbus, OH: Charles E. Merrill, 1987.
- Strickland, Dorothy S., and Michael R. Strickland "Language and Literacy: The Poetry Connection." *Language Arts* 74 (Mar. 1997): 201–205.
- Turner, Julianne C. "Starting Right: Strategies for Engaging Young Literacy Learners." *Reading Engagement: Motivating Readers through Integrated Sources*. Ed. John T. Guthrie and Allan Wigfield. Newark, DE: International Reading Association, 1997. 183–204.
- Turner, T., and W. DiMarco. *Learning to Teach Science in the Secondary School*. London, UK: Routledge, 1998.
- United Nations Educational, Scientific and Cultural Organization (UNESCO). "Le développement durable grace a l'éducation relative a l'environnement." *Connexion* 13.2 (June 1988): 3.

- van Kessel, Hans, Frank Jenkins, Lucille Davies, Donald Plumb, Maurice Di Giuseppe, Oliver Lanz, and Dick Tompkins. *Nelson Chemistry 12*. Ontario Edition. Toronto, ON: Thomson Nelson, 2003.
- Wagner, Maxine. *Prentice Hall Chemistry: The Study of Matter, Laboratory Manual*. 3rd ed. Needham, MA: Prentice Hall, Inc., 1989.
- Waterman, Edward L., and Stephen Thompson. *Prentice Hall Chemistry: Small-Scale Chemistry Laboratory Manual*. Boston, MA: Pearson Prentice Hall, 2004.
- White, B. Y., and J. R. Frederiksen. "Inquiry, Modeling, and Metacognition: Making Science Accessible to All Students." *Cognition and Instruction* 16.1 (1998): 3-118.
- Whitman, Ronald Laurie, and Ernest E. Zinck. *Prentice Hall Chemistry Today: Laboratory Manual*. Scarborough, ON: Prentice-Hall of Canada, 1976.
- Wiggins, Grant. "What Is a Rubric? A Dialogue on Design and Use." *A Handbook for Student Performance Assessment in the Era of Restructuring*. Ed. Robert E. Blum and Judith A. Arter. Alexandria, VA: Association for Supervision and Curriculum Development (ASCD), 1995. VI-5: 1-13.
- Wilbraham, Antony C., Dennis D. Staley, and Michael S. Matta. *Prentice Hall Chemistry: Laboratory Manual*. Boston, MA: Pearson Prentice Hall, n.d.
- \_\_\_\_\_. *Prentice Hall Chemistry: Laboratory Manual, Teacher's Edition*. Boston, MA: Pearson Prentice Hall, n.d.
- Wilbraham, Antony C., Dennis D. Staley, Michael S. Matta, and Edward L. Waterman. *Prentice Hall Chemistry*. Upper Saddle River, NJ: Pearson Education/Prentice Hall, 2005.
- \_\_\_\_\_. *Prentice Hall Chemistry: Small-Scale Chemistry Laboratory Manual*. Upper Saddle River, NJ: Pearson Education/Prentice Hall, 2005.
- Williams, Robin. *The Non-Designer's Design Book: Design and Typographic Principles for the Visual Novice*. Berkeley, CA: Peachpit Press, 1994.
- Willis, Scott. "Interdisciplinary Learning: Movement to Link the Disciplines Gains Momentum." *ASCD Curriculum Update* (Nov. 1992): 1-8.
- Wood, D., J. Bruner, and G. Ross. "The Role of Tutoring in Problem Solving." *Journal of Child Psychology and Psychiatry* 17 (1976): 89-100.
- Zumdahl, Steven S., and Susan A. Zumdahl. *Chemistry*. 5th ed. Boston, MA: Houghton-Mifflin, 2000.

## Websites

- Becker, Robert. "pH Rainbow Tube." 1999. Flinn Scientific, Inc. Available on the Northern Kentucky University website at [www.nku.edu/~sieveb1/makeandtake2011.pdf](http://www.nku.edu/~sieveb1/makeandtake2011.pdf) (17 Apr. 2012).
- Blauch, David N. "Rate of Reaction." *Virtual Chemistry Experiments: Chemical Kinetics*. 2001, 2009. Chemistry@Davidson. [www.chm.davidson.edu/vce/kinetics/RateOfReaction.html](http://www.chm.davidson.edu/vce/kinetics/RateOfReaction.html) (8 Feb. 2012).
- Blickenstaff, Jacob Clark. "Haber: Ethics in the Laboratory." 21 Jan. 2011. *National Science Teachers Association*. [www.nsta.org/publications/news/story.aspx?id=58157&print=true](http://www.nsta.org/publications/news/story.aspx?id=58157&print=true) (27 Dec. 2012).
- Brown, W. P. "Factors Affecting the Speed-Rates of Chemical Reactions." *Doc Brown's Chemistry*. 2000–2010. [www.docbrown.info/page03/3\\_31rates.htm](http://www.docbrown.info/page03/3_31rates.htm) (8 Feb. 2012).
- Carboni, Giorgio. *Experiments in Electrochemistry*. 1998. Fun Science Gallery. [www.funsci.com/fun3\\_en/electro/electro.htm](http://www.funsci.com/fun3_en/electro/electro.htm) (5 Apr. 2012).
- \_\_\_\_\_. "The Lemon Battery." 1998. *Experiments in Electrochemistry*. 1998. Fun Science Gallery. [www.funsci.com/fun3\\_en/electro/electro.htm#2](http://www.funsci.com/fun3_en/electro/electro.htm#2) (10 Apr. 2012).
- Chang, Raymond. "Essential Study Partner." *Chemistry*. 7th ed. McGraw Hill Online Learning Centre. [http://highered.mcgraw-hill.com/sites/0073656011/student\\_view0/chapter15/essential\\_study\\_partner.html#](http://highered.mcgraw-hill.com/sites/0073656011/student_view0/chapter15/essential_study_partner.html#) (21 Mar. 2012).
- The ChemCollective. "Periodic Table." *Applets*. [www.chemcollective.org/applets/pertable.php](http://www.chemcollective.org/applets/pertable.php) (1 Feb. 2012).
- Chemical Education Research Group, Iowa State University. *Chemical Education*. [www.chem.iastate.edu/group/Greenbowe/sections/projectfolder/animationsindex.htm](http://www.chem.iastate.edu/group/Greenbowe/sections/projectfolder/animationsindex.htm) (22 Nov. 2012).
- \_\_\_\_\_. "Chemistry Experiment Simulations and Conceptual Computer Animations." *Chemical Education*. <http://group.chem.iastate.edu/Greenbowe/sections/projectfolder/simDownload/index4.html> (22 Nov. 2012).
- Chemistry@Davidson. "Electronegativity: Pauling, Allred-Rochow, and Mulliken-Jaffé." *Dr. Nutt's CHE 115 Course*. [www.chm.davidson.edu/ronutt/che115/electroneg.htm](http://www.chm.davidson.edu/ronutt/che115/electroneg.htm) (8 Feb. 2012).
- Clark, Jim. "Acid-Base Indicators." *Chemguide*. 2002, mod. Dec. 2006. [www.chemguide.co.uk/physical/acidbaseeqia/indicators.html](http://www.chemguide.co.uk/physical/acidbaseeqia/indicators.html) (22 Nov. 2012).
- \_\_\_\_\_. "The Haber Process." *Chemguide*. 2002. [www.chemguide.co.uk/physical/equilibria/haber.html](http://www.chemguide.co.uk/physical/equilibria/haber.html) (13 Jan. 2012).
- \_\_\_\_\_. "An Introduction to Redox Equilibria and Electrode Potentials." *Chemguide*. 2002. [www.chemguide.co.uk/physical/redoxeqia/introduction.html](http://www.chemguide.co.uk/physical/redoxeqia/introduction.html) (13 Jan. 2012).

- Corrosion Doctor. *Who's Who in Electrochemistry*.  
 <[www.corrosion-doctors.org/Who's\\_who.htm](http://www.corrosion-doctors.org/Who's_who.htm)> (5 Apr. 2012).
- Energy Quest. *Super Scientists: A Gallery of Energy Pioneers*. 2006.  
 <[www.energyquest.ca.gov/scientists/](http://www.energyquest.ca.gov/scientists/)> (5 Apr. 2012).
- Flinn Scientific, Inc. "Indicator Sponge: A Discrepant Event Demonstration." 2009.  
*Chem Fax!*  
 <[www.flinnsci.com/Documents/demoPDFs/Chemistry/CF10376.pdf](http://www.flinnsci.com/Documents/demoPDFs/Chemistry/CF10376.pdf)>  
 (18 May 2012).
- \_\_\_\_\_. *Orange Juice to Strawberry Float*. 2009. YouTube.  
 <[www.youtube.com/watch?v=UVdbG9-mHyc&feature=BFa&list=ULUVdbG9-mHyc&lf=channel](http://www.youtube.com/watch?v=UVdbG9-mHyc&feature=BFa&list=ULUVdbG9-mHyc&lf=channel)> (17 Apr. 2012).
- \_\_\_\_\_. "Orange Juice to Strawberry Float: A Foamy Acid-Base Demonstration."  
 2010. *Chem Fax!*  
 <[www.flinnsci.com/Documents/demoPDFs/Chemistry/CF0516.00.pdf](http://www.flinnsci.com/Documents/demoPDFs/Chemistry/CF0516.00.pdf)>  
 (17 Apr. 2012).
- Glencoe Online. "An Internet WebQuest: The History of Fireworks." *WebQuest Science*. <[www.glencoe.com/sec/science/webquest/content/fireworks.shtml](http://www.glencoe.com/sec/science/webquest/content/fireworks.shtml)>  
 (1 Feb. 2012).
- Gouge, Edward M. "A Flame Test Demonstration Device." *Journal of Chemical Education* 65.6 (June 1988): 544. Available at  
 <<http://pubs.acs.org/doi/abs/10.1021/ed065p544>> (13 Jan. 2012).
- Greenslade, Thomas B. "The Electrochemical Cell." *Instruments for Natural Philosophy*. <[http://physics.kenyon.edu/EarlyApparatus/Electricity/Electrochemical\\_Cell/Electrochemical\\_Cell.html](http://physics.kenyon.edu/EarlyApparatus/Electricity/Electrochemical_Cell/Electrochemical_Cell.html)> (5 Apr. 2012).
- Holmquist, Dan D. Jack Randall, and Donald L. Volz. "Experiment 30: Rate Law Determination of the Crystal Violet Reaction." *Chemistry with Vernier*. Beaverton, OR: Vernier, 2007. Available online at <[www.vernier.com/experiments/cwv/30/rate\\_law\\_determination\\_of\\_the\\_crystal\\_violet\\_reaction/](http://www.vernier.com/experiments/cwv/30/rate_law_determination_of_the_crystal_violet_reaction/)> (7 June 2012).
- HowStuffWorksVideos. *Fireworks Videos*. 1998–2012.  
 <<http://videos.howstuffworks.com/science/fireworks-videos-playlist.htm#video-8329>> (13 Jan. 2012).
- International Union of Pure and Applied Chemistry (IUPAC). Home Page.  
 <[www.iupac.org](http://www.iupac.org)> (18 Jan. 2012).
- Keusch, Peter. "Belousov-Zhabotinsky Reaction." *Organic Chemistry Demonstration Experiments on Video: Chemistry Visualized*. University of Regensburg.  
 <[www.uni-regensburg.de/Fakultaeten/nat\\_Fak\\_IV/Organische\\_Chemie/Didaktik/Keusch/D-oscill-e.htm](http://www.uni-regensburg.de/Fakultaeten/nat_Fak_IV/Organische_Chemie/Didaktik/Keusch/D-oscill-e.htm)> (22 Feb. 2012).
- Lori's Chemistry Page. *Complete with the Glowing Pickle*.  
 <<http://myglowingpickle.com/>> (30 Jan. 2012).

- Magnetic Lab: National High Magnetic Field Laboratory. "Voltaic Pile." *Education*. 1995–2012. <[www.magnet.fsu.edu/education/tutorials/java/voltaicpile1/index.html](http://www.magnet.fsu.edu/education/tutorials/java/voltaicpile1/index.html)> (22 Aug. 2012).
- Manitoba Education. "Bibliographies." *Learning Resources*. <[www.edu.gov.mb.ca/k12/learnres/bibliographies.html](http://www.edu.gov.mb.ca/k12/learnres/bibliographies.html)> (6 Sept. 2012).
- The North Carolina School of Science and Mathematics (NCSSM). "Chapter 14: Gas Phase, Solubility, Complex Ion Equilibria." *Chemistry Online Resource Essentials (CORE)*. <[www.dlt.ncssm.edu/core/c14.htm](http://www.dlt.ncssm.edu/core/c14.htm)> (15 Feb. 2012).
- \_\_\_\_\_. "Chapter 15: Kinetics." *Chemistry Online Resource Essentials (CORE)*. <[www.dlt.ncssm.edu/core/c15.htm](http://www.dlt.ncssm.edu/core/c15.htm)> (9 Feb. 2012).
- \_\_\_\_\_. Distance Education and Extended Programs. "Chemistry – Electrochemistry." *Teacher's Instructional Graphics and Educational Resource (TIGER)*. <[www.dlt.ncssm.edu/tiger/chem6.htm#electro](http://www.dlt.ncssm.edu/tiger/chem6.htm#electro)> (11 Apr. 2012).
- \_\_\_\_\_. \_\_\_\_\_. "Chemistry Graphics – Moles." *Teacher's Instructional Graphics and Educational Resource (TIGER)*. <[www.dlt.ncssm.edu/tiger/chem2.htm#moles](http://www.dlt.ncssm.edu/tiger/chem2.htm#moles)> (18 Jan. 2012).
- \_\_\_\_\_. \_\_\_\_\_. "Chemistry – Kinetics." *Teacher's Instructional Graphics and Educational Resource (TIGER)*. <[www.dlt.ncssm.edu/tiger/chem5.htm#kinetics](http://www.dlt.ncssm.edu/tiger/chem5.htm#kinetics)> (10 Feb. 2012).
- \_\_\_\_\_. \_\_\_\_\_. "Science Secondary Level." *STEM@NCSSM*. <[www.dlt.ncssm.edu/stem/sci-secondary](http://www.dlt.ncssm.edu/stem/sci-secondary)> (3 Aug. 2012).
- Oklahoma State University. Department of Chemistry. "Double Displacement/ Replacement Reactions." *Chem 1314*. <<http://intro.chem.okstate.edu/1314F00/Lecture/Chapter4/Lec92700.html>>.
- PASCO. "Reaction Order." 1996–2012. *Chemistry*. <[www.pasco.com/chemistry/kinetics-and-equilibrium/reactionorder.cfm](http://www.pasco.com/chemistry/kinetics-and-equilibrium/reactionorder.cfm)> (9 May 2012).
- Petrucci, Ralph H., William S. Harwood, and Geoffrey Herring. "Chapter 15: Chemical Kinetics." *General Chemistry: Principles and Modern Applications*. 8th ed. Prentice Hall, Inc. <[http://cwx.prenhall.com/petrucci/medialib/media\\_portfolio/15.html](http://cwx.prenhall.com/petrucci/medialib/media_portfolio/15.html)> (8 May 2012).
- Pyro Universe. Home Page. <[www.pyrouniverse.com](http://www.pyrouniverse.com)> (31 Jan. 2012).
- Science Bob. "Crazy Foam Experiment." *Science Bob Videos*. <[www.sciencebob.com/experiments/videos/video-foam1.php](http://www.sciencebob.com/experiments/videos/video-foam1.php)> (13 Jan. 2012).
- Schwabacher, Alan. "Mini Spectroscopes." *The Science of Stuff*. Rev. 8 Jan. 2002. University of Wisconsin. Department of Chemistry. <<https://pantherfile.uwm.edu/awschwab/www/specweb.htm>> (13 Jan. 2012).
- ScienceGeek.net. "AP Chemistry Powerpoints." *AP Chemistry*. <[www.sciencegeek.net/APChemistry/Powerpoints.shtml](http://www.sciencegeek.net/APChemistry/Powerpoints.shtml)> (1 Feb. 2012).

- \_\_\_\_\_. "Printable Periodic Tables." *Other Resources*.  
 <[www.sciencegeek.net/tables/tables.shtml](http://www.sciencegeek.net/tables/tables.shtml)> (1 Feb. 2012).
- Sea and Sky. "Reefkeeper's FAQ." *Aquarium Resources*.  
 <[www.seasky.org/aquarium/aquarium\\_faq\\_page01.html](http://www.seasky.org/aquarium/aquarium_faq_page01.html)> (21 Mar. 2012).
- SparkNotes Editors. "SparkNote on Titrations." *SparkNotes.com*. SparkNotes LLC.  
 n.d. <[www.sparknotes.com/chemistry/acidsbases/titrations/section1.html](http://www.sparknotes.com/chemistry/acidsbases/titrations/section1.html)>  
 (21 Mar. 2012).
- Süss-Fink, Georg, and Frédéric Chérioux. "6.2: Scheme of Electrochemical Cell."  
*Unit 5: Electron Transfer Reactions*. 2005. *General Chemistry*.  
 <<http://chimge.unil.ch/En/redox/1red13.htm>> (10 Apr. 2012).
- Tanis, Dave. *Demonstrations in Chemistry Classrooms, Michigan Science Teachers  
 Association Conference*. 14 Mar. 2003.  
 <<http://alittlecreation.com/science/Chemistry/tanis-chem.pdf>> (6 Aug. 2010).
- University of Colorado at Boulder. "Atomic Spectra." *Physics 2000: Science Trek*.  
 <[www.colorado.edu/physics/2000/quantumzone/lines2.html](http://www.colorado.edu/physics/2000/quantumzone/lines2.html)> (3 Aug. 2012).
- \_\_\_\_\_. "Reactions and Rates." *PhET Interactive Simulations*.  
 <<http://phet.colorado.edu/en/simulation/reactions-and-rates>> (22 Nov. 2012).
- \_\_\_\_\_. "Salts and Solubility." *PhET Interactive Simulations*.  
 <<http://phet.colorado.edu/en/simulation/soluble-salts>> (22 Nov. 2012).
- \_\_\_\_\_. "Spectral Line." *Physics 2000: Science Trek*.  
 <[www.colorado.edu/physics/2000/quantumzone/index.html](http://www.colorado.edu/physics/2000/quantumzone/index.html)> (1 Feb. 2012).
- Virtual Crezlab Qualitative Analysis. "Acid-Base Reactions." *Teaching Laboratory*.  
 Crescent Girls' School.  
 <[www.crescent.edu.sg/crezlab/webpages/AcidReaction3.htm](http://www.crescent.edu.sg/crezlab/webpages/AcidReaction3.htm)> (18 Jan. 2012).
- \_\_\_\_\_. "Displacement Reaction." *Teaching Laboratory*. Crescent Girls' School.  
 <[www.crescent.edu.sg/crezlab/webpages/pptReaction3.htm](http://www.crescent.edu.sg/crezlab/webpages/pptReaction3.htm)> (3 Apr. 2012).
- \_\_\_\_\_. "Precipitation Reactions: Precipitation Explained." *Teaching Laboratory*.  
 Crescent Girls' School.  
 <[www.crescent.edu.sg/crezlab/webpages/pptReaction3.htm](http://www.crescent.edu.sg/crezlab/webpages/pptReaction3.htm)> (18 Jan. 2012).
- \_\_\_\_\_. "Precipitation Reactions: Another Example of Precipitation Reaction."  
*Teaching Laboratory*. Crescent Girls' School.  
 <[www.crescent.edu.sg/crezlab/webpages/pptReaction4.htm](http://www.crescent.edu.sg/crezlab/webpages/pptReaction4.htm)> (18 Jan. 2012).
- Visionlearning, Inc. "Bohr's Atom: Quantum Behavior in Hydrogen." *Library*.  
 <[www.visionlearning.com/library/flash\\_viewer.php?oid=1347&mid=51](http://www.visionlearning.com/library/flash_viewer.php?oid=1347&mid=51)>  
 (3 Aug. 2012).
- The WebQuest Page. Home Page. <<http://webquest.org/index.php>>  
 (28 Aug. 2012).



Wyatt, Shawn. "Go-Science Traffic Light Reaction Chemistry Demonstration." *World News*. <[http://wn.com/Traffic\\_Light\\_Reaction\\_GO-Science\\_Demonstration](http://wn.com/Traffic_Light_Reaction_GO-Science_Demonstration)> (22 Feb. 2012).







Printed in Canada  
Imprimé au Canada