

PREPARATION, SURFACE FINISHES & TOOLS

STONE BLOCK
SAWN INTO
SLABS

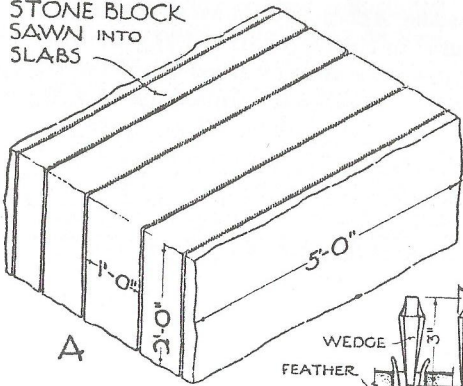

A

SPLITTING A
BLOCK OF
STONE

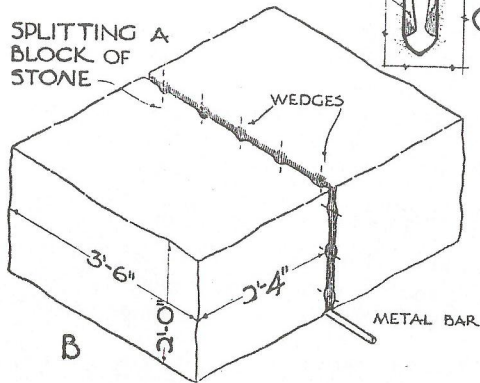

B

FORMING A
TRUE FACE

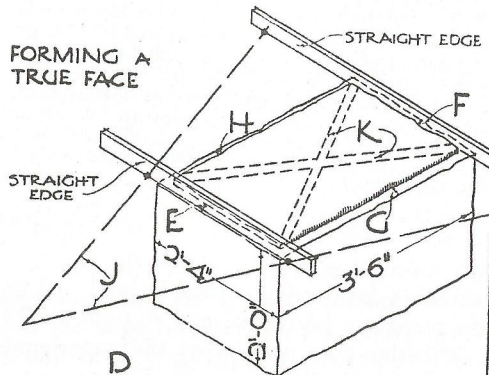

D

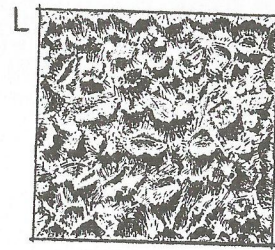
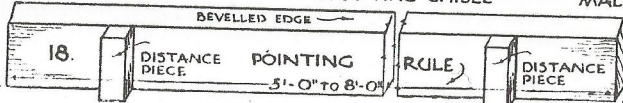
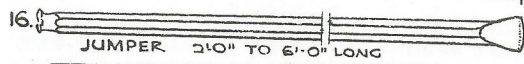

HAMMER DRESSED

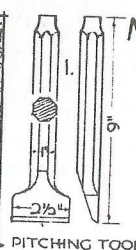

PITCHING TOOL

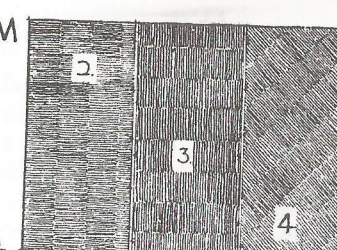

BOASTED

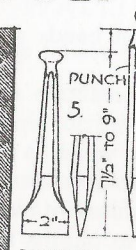

BOASTER

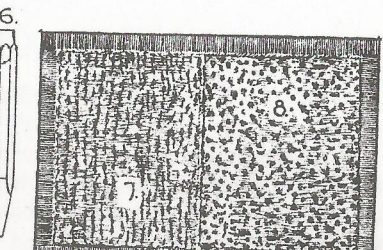

PUNCHED

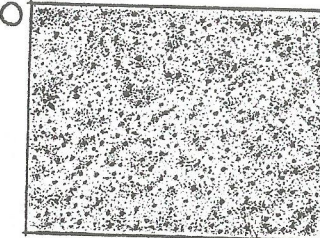

PICKED

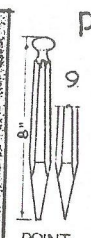

POINT

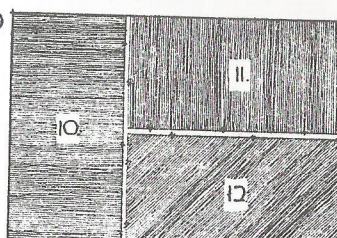

TOOLED

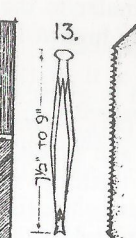

COLIGE

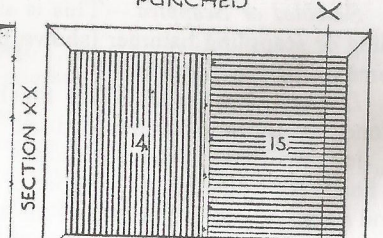

FURROWED

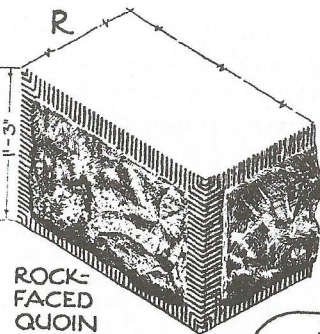

ROCK-
FACED
QUOIN



VERMICULATED

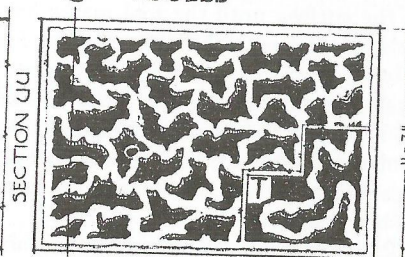

SECTION UU

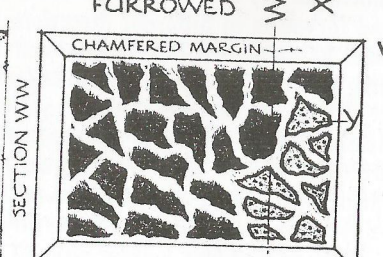

RETICULATED

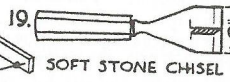

SOFT STONE CHISEL

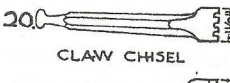

CLAW CHISEL

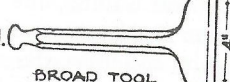

BROAD TOOL

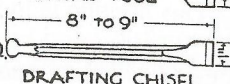

DRAFTING CHISEL



DRAG

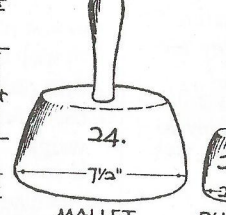

MALLET

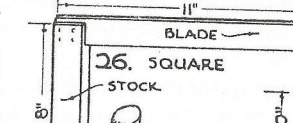

SQUARE

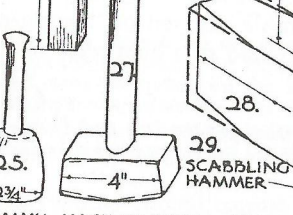

DUMMY MASH HAMMER

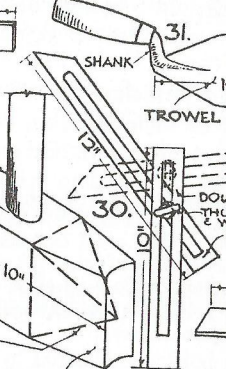

SPALL HAMMER

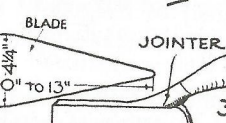

BEVEL

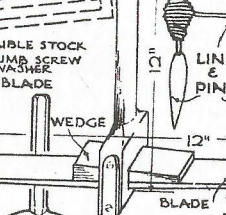

TROWEL



JOINTER

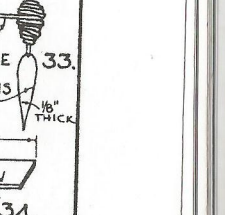

LINE & PINS

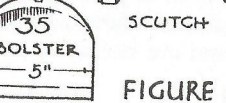

BOLSTER

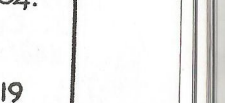

SCUTCH

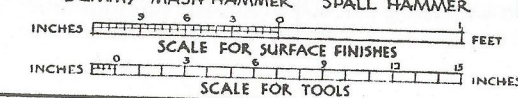

FIGURE 19