

# Gwathmey Siegel

Buildings and Projects  
1965–2000

*Introduction by Charles Gwathmey*



## Solomon R. Guggenheim Museum Addition, Renovation, and Restoration

Design/Completion 1982/1992

New York, New York

The Solomon R. Guggenheim Foundation

30,000 square feet (addition); 120,000 square feet (renovation)

Prefabricated limestone panels on steel trusses, painted aluminum, glass, glass block, stainless steel, bronze, glass fiber, reinforced concrete columns

Painted gypsum; painted plaster; sand bed, precast, and epoxy terrazzo; opaque glass; metal panels; stainless steel and bronze doors and railings

The program included the renovation and restoration of the Frank Lloyd Wright museum and a 30,000-square-foot addition to the original building.

The parti for the addition was determined by its two critical intersections with the original building: with the rotunda at the existing circulation core, and with the monitor building along its east wall. At the triangular stair, the addition provides balcony views and access to the rotunda from three new two-story galleries and one single-story gallery. The hinge/knuckle stair is experienced from the new galleries as both a space and an object. The transparent glass wall between the monitor building and the addition reveals the original facades from the outside in and the inside out. The rotunda becomes a "courtyard/cloister" space for both the addition and the monitor building.

The second floor of the monitor building was renovated as a gallery in 1954, establishing a precedent for the spatial interconnection between the monitor building and the large rotunda. This precedent was extended by converting each floor of the monitor building into exhibition space and by integrating the pavilions, functionally and spatially, with the large rotunda as well as with the new addition. The interconnected pavilions offer views to Central Park and to the skylit

*Continued*



1 View from Fifth Avenue

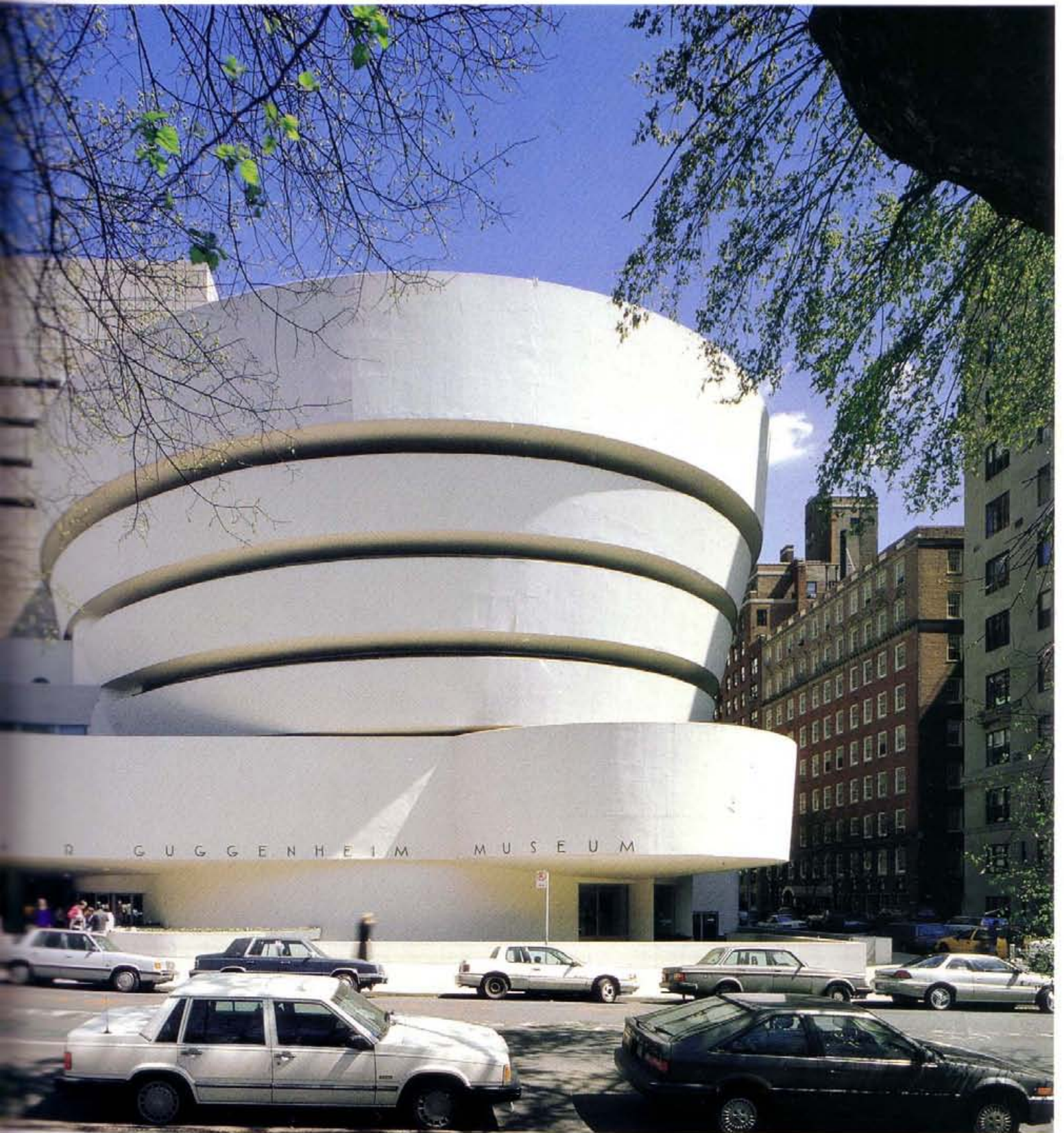

- 2 Aerial view
- 3 Detail of north facade, showing glass wall between addition and monitor building
- 4 New roof terrace, showing intersection of large rotunda and addition
- 5 Floor plans

small rotunda, a counterpoint to the large rotunda. Outside, the new fifth-floor roof sculpture terrace, the large rotunda roof terrace, and the renovated public ramp from the street to the auditorium reveal the original building in a new, extended, and comprehensive perspective.

In the rotunda, numerous technical refinements have corrected omissions in the original construction and brought the building up to current museum standards. The reglazing of the central lantern, the re-opening of the clerestories that run between the turns of the spiral wall, and the restoration of the scalloped flat clerestory at the perimeter of the ground floor exhibition space have restored the quality of light that was evident in the original design. The high gallery set the original precedent for leaving and re-entering the ramp/rotunda. Each ramp cycle now affords the option of entry or views to new galleries. Most significantly, the extension of the uppermost ramp of the rotunda, which had been closed to the public since it was built, creates alternative circulation back to the ground floor and provides a culmination to this major public space for the first time.

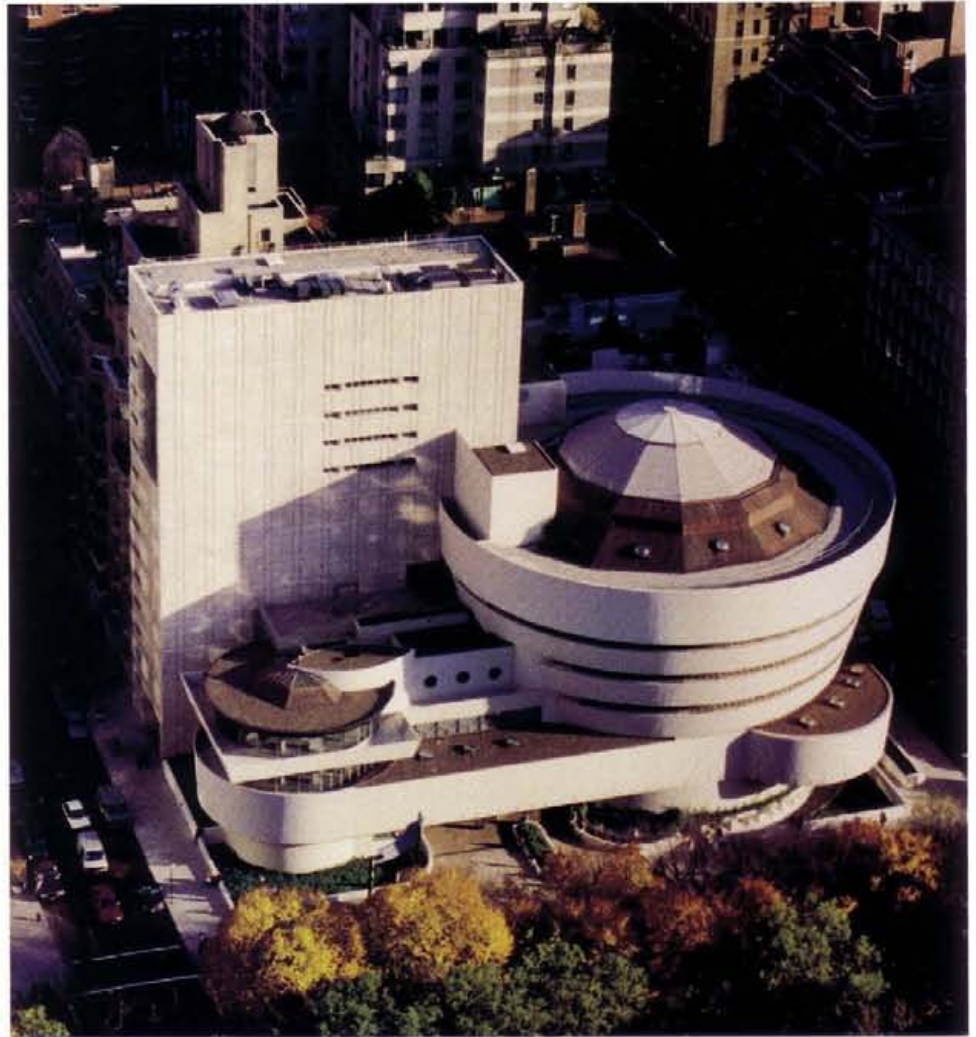

2



3



4

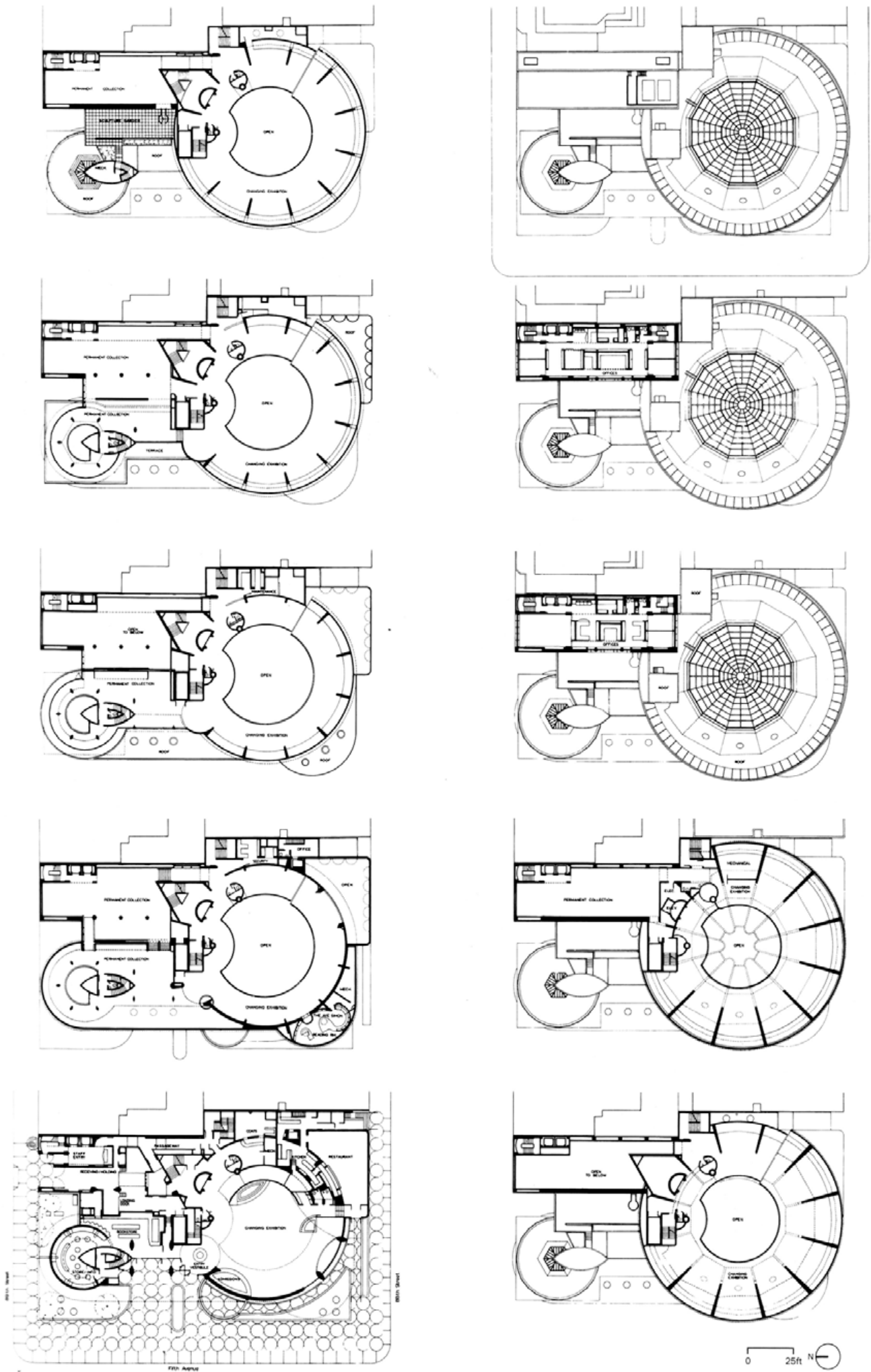

- 6 New fifth and sixth level gallery with access to roof terrace
- 7 New second and third level gallery with Thannhauser gallery beyond
- 8 Fourth level gallery in monitor building with reconstructed cornice
- 9 Renovated seventh level ramp in large rotunda



6



7



8



9



## American Museum of the Moving Image

Design/Completion 1983/1988

Astoria, New York

American Museum of the Moving Image

55,000 square feet

Painted concrete, aluminum, single-ply ballasted roofing

This specialized museum is housed in a three-story 1920s concrete loft building, adjacent to the Astoria Moving Picture Studio Complex. The existing window openings were reglazed and the stucco exterior masonry repaired, as required by the National Registration of Historic Buildings.

Located on the ground floor are the flexible exhibition gallery, a state-of-the-art 200-seat movie theater, a bookstore/museum shop, and the lobby and cafe area. On the second floor are administrative offices, a multi-use exhibition loft, and the Movie Palace. The third floor and roof pavilion provide exhibition and entertainment space.

The new stair and elevator tower, located in the courtyard beyond the original facade and on axis with the main entrance, reads as a counterpoint object to the original frame. Landings provide visitors with a heightened visual experience before re-entering the exhibition spaces in the original building.

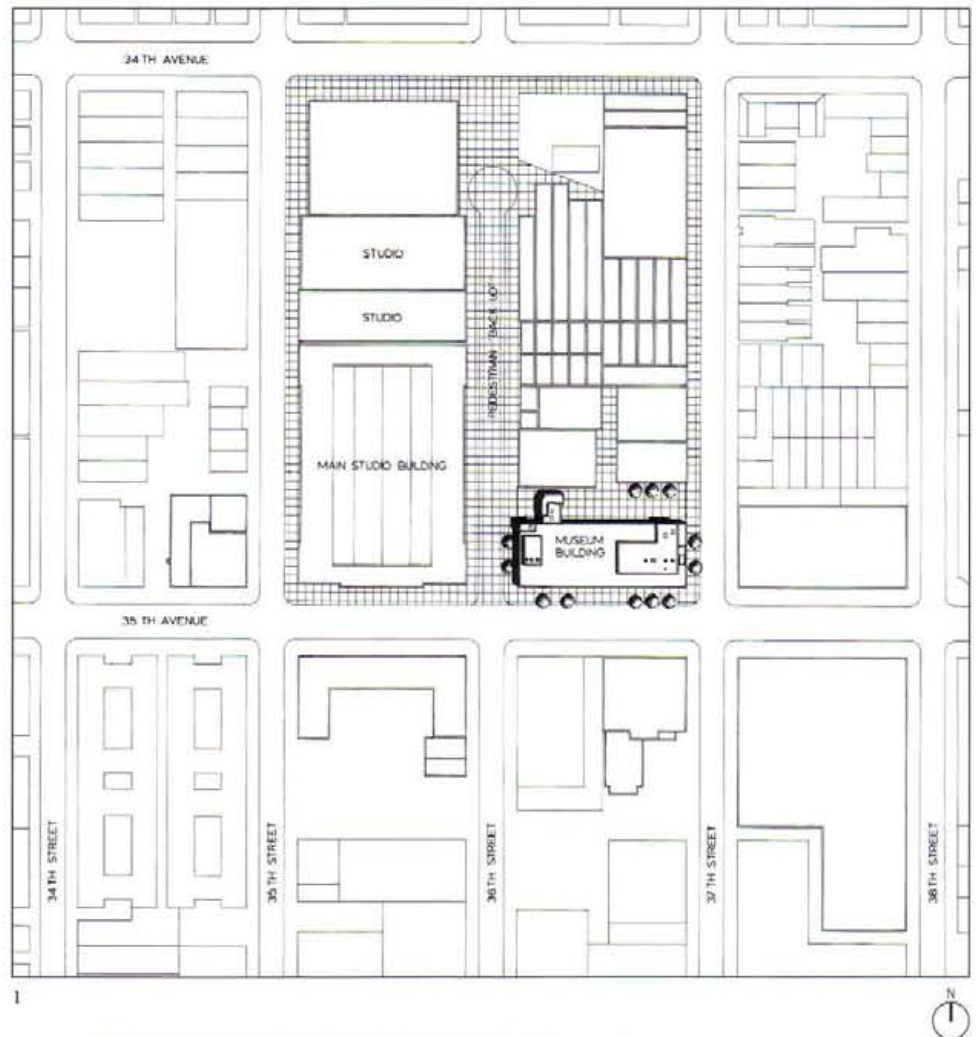

1



2

- 1 Site plan
- 2 Landmarked facade of renovated building
- 3 View of new stair tower from courtyard



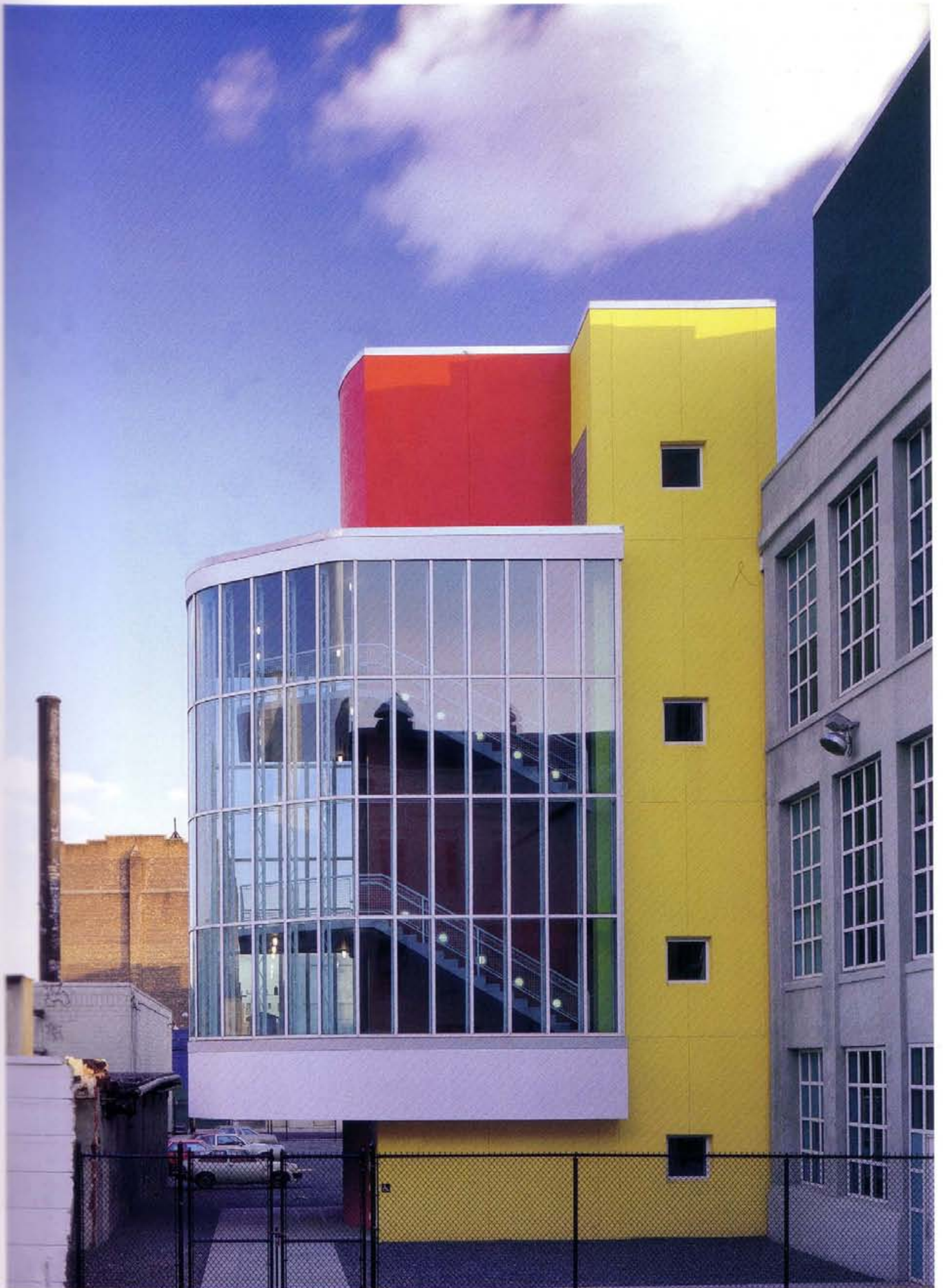



4



5

- 4 View of new stair tower from courtyard
- 5 View of new stair tower at dusk
- 6 Stair tower detail

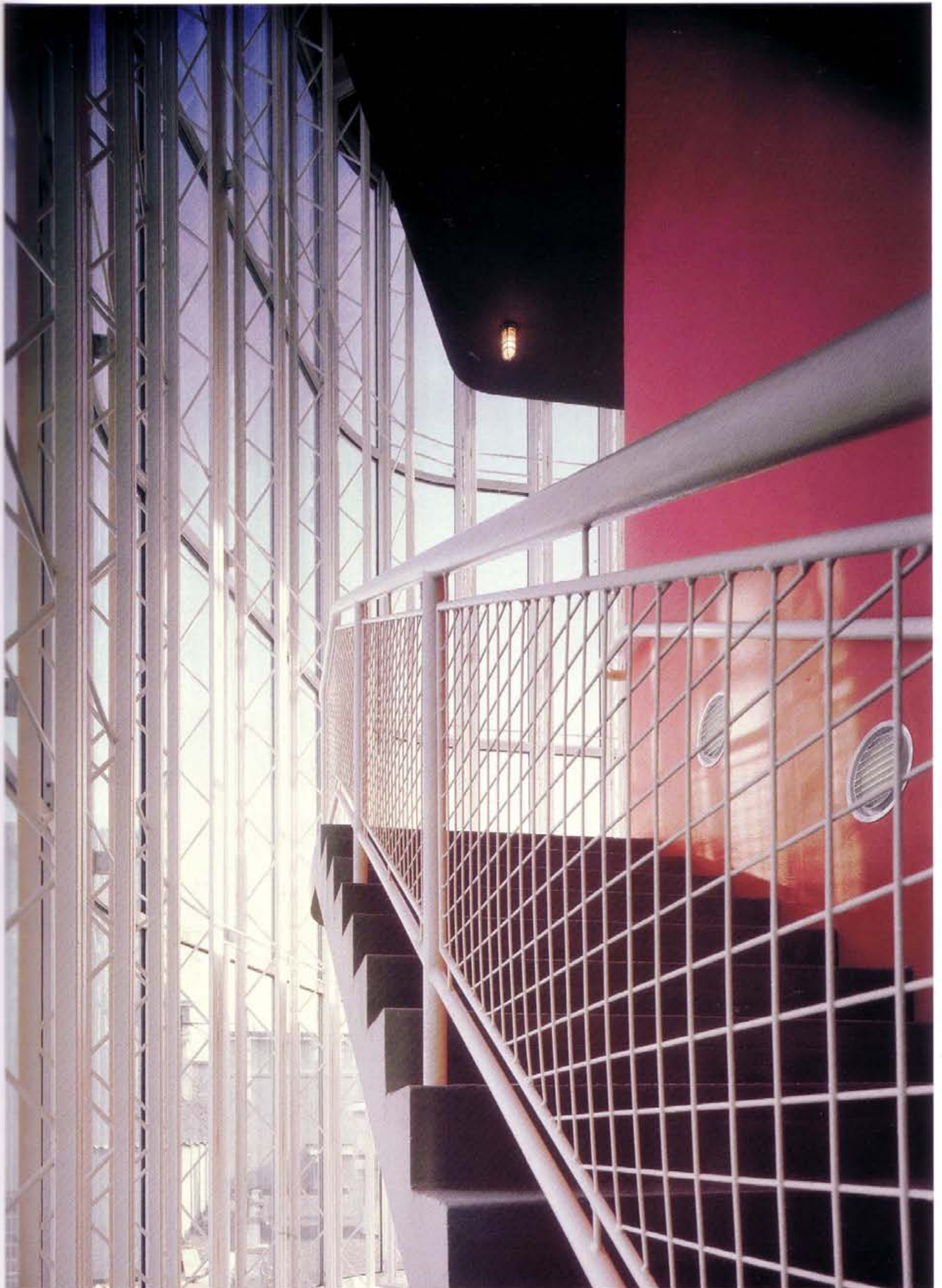

- 7 Second floor axonometric
- 8 Ground floor axonometric
- 9 Second floor exhibition gallery: costume tent
- 10 New 200-seat movie theater
- 11 Red Groom's "Tuts Fever Movie Theater Palace": marquee detail
- 12 Red Groom's "Tuts Fever Movie Theater Palace": detail

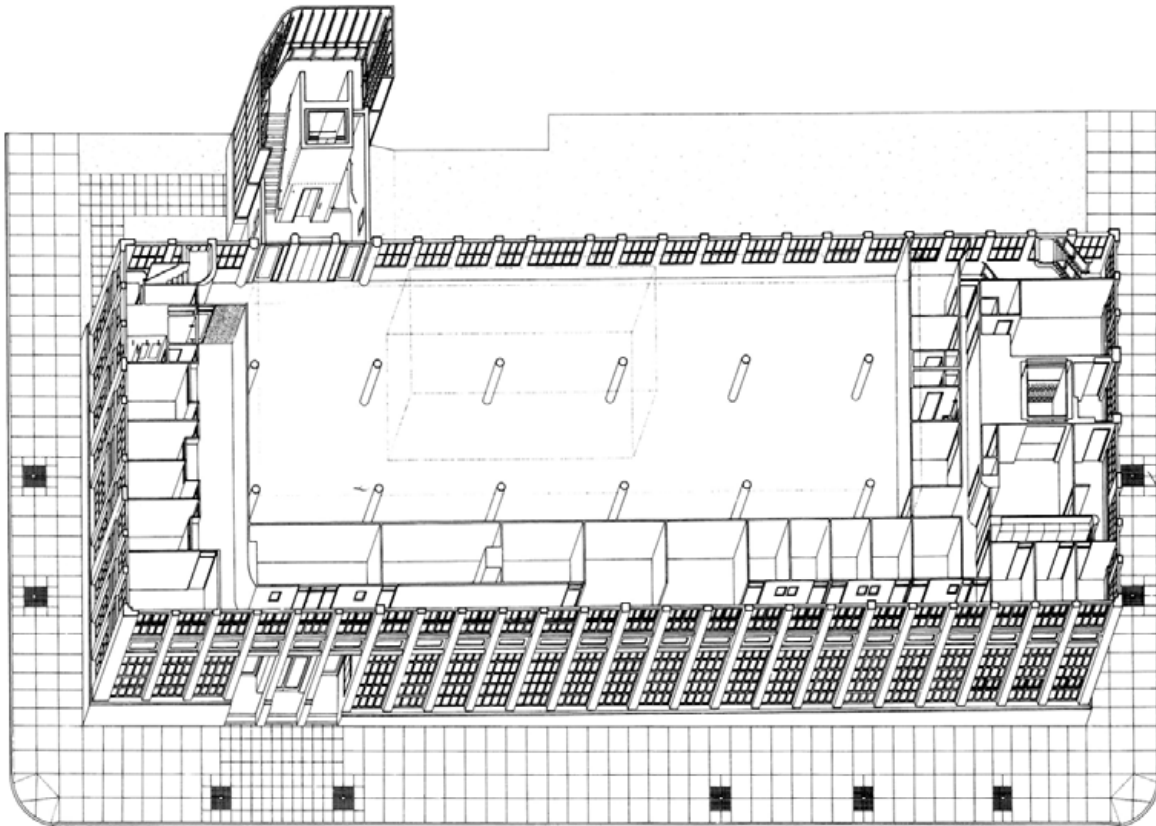

7

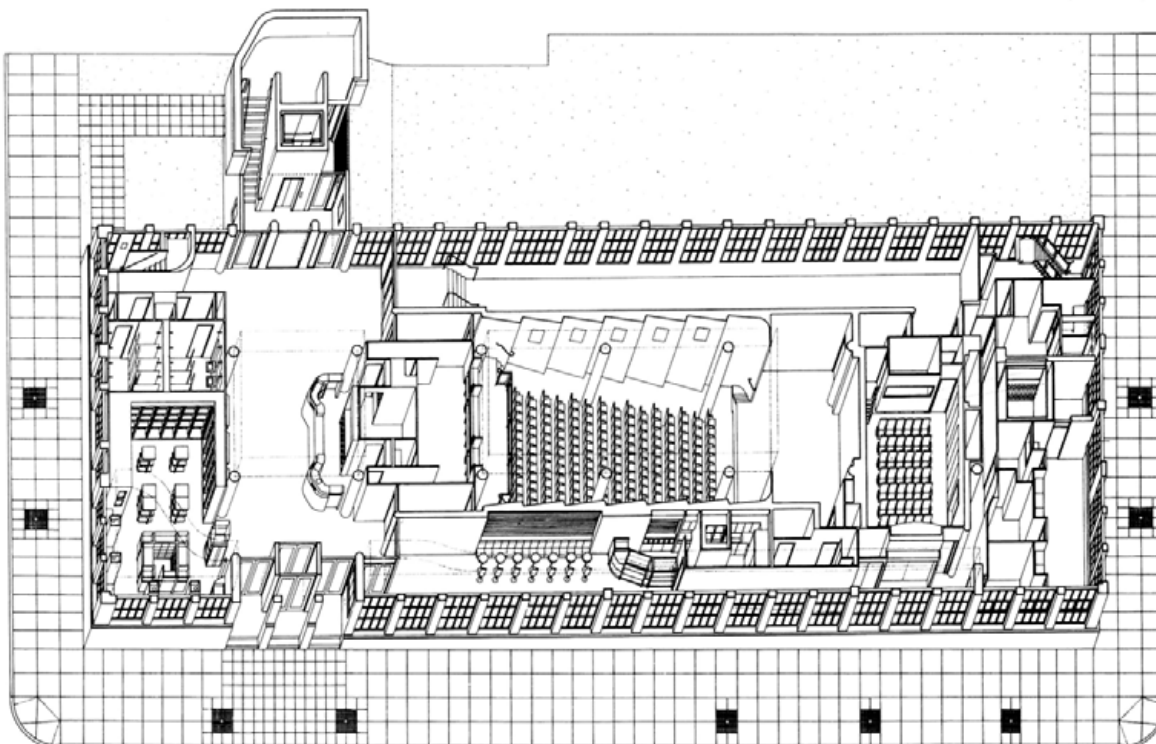

8



10



11

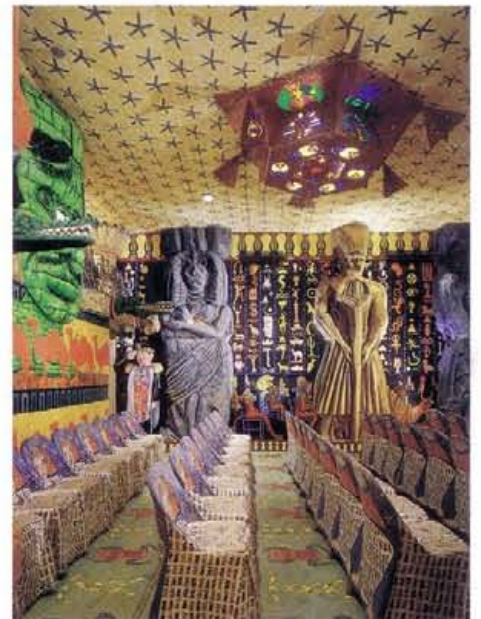

12

# John W. Berry Sports Center, Dartmouth College

Design/Completion 1984/1988

Hanover, New Hampshire

Dartmouth College

118,000 square feet

Groundface concrete block, brick, stone, painted wood

This building addition is an expansion of the athletics facilities of the original Alumni Gymnasium. It is located within a traditional brick and stone Ivy League campus, and adjacent to athletics fields, tennis courts, and residential streets.

The ground floor houses a 2,200-seat intercollegiate basketball arena which reconfigures into a three-court gymnasium; a physical fitness center and classroom; varsity locker rooms; athletics ticket offices; and a concession area.

The second floor, reached by two stairs and a bridge from the renovated Alumni Gymnasium, houses seven competition squash courts, six racquetball courts, a dance studio, and spectator bleacher balconies. The facilities are accessed from a barrel-vaulted, skylit gallery, terminated by a bay window overlooking the entry.

Horizontal and vertical circulation elements wrap the three sides of the basketball arena, allowing natural light into the fitness center and dance studio. Exterior materials address contextual constraints and articulate the internal volumes as well as the layered organization of the plan.

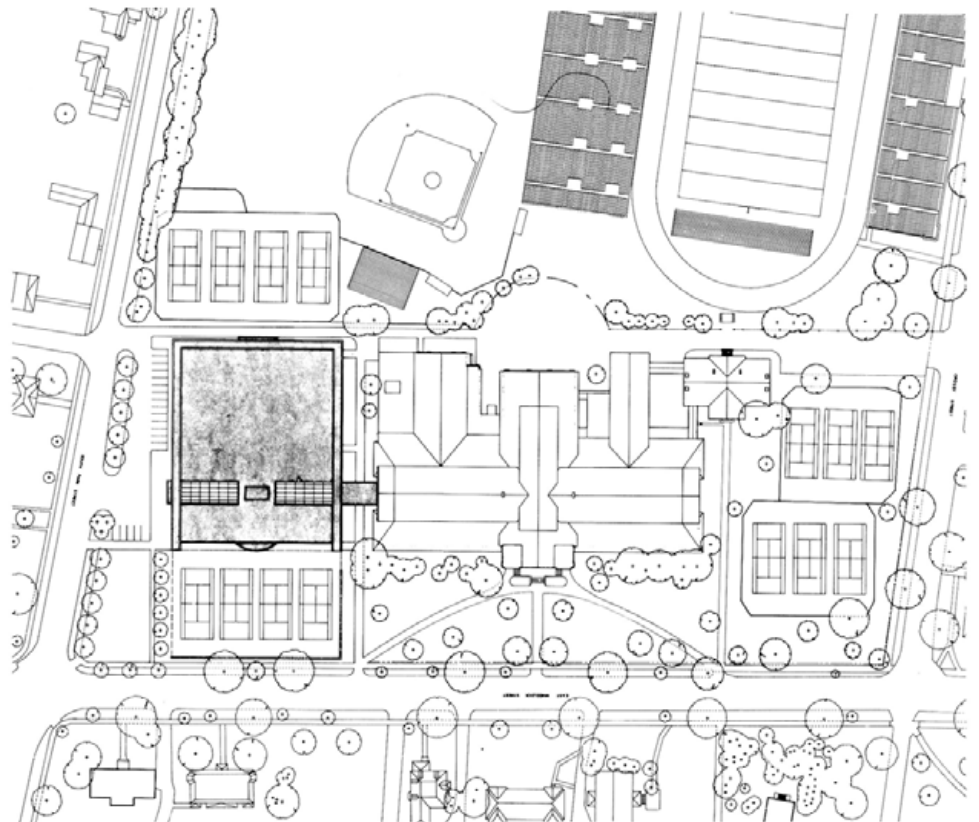

1



- 1 Site plan
- 2 Ground level plan
- 3 Upper level plan
- 4 View of public entry facade with gallery bay window above
- 5 View showing connection bridge from existing building
- 6 Rear elevation
- 7 Night view of north facade from tennis courts
- 8 Northwest corner of building from lawn

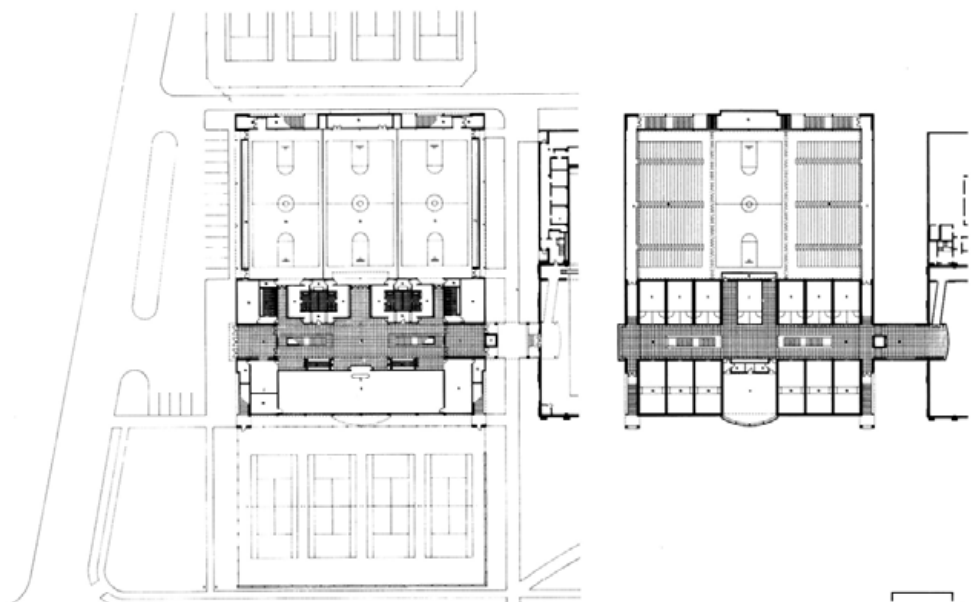

2





4



5



6



7



8

- 9 Three-glass-wall exhibition squash court
- 10&11 Basketball arena
- 12 Dance studio
- 13 North elevation
- 14 Spectator gallery for squash courts, showing stairs from lobby and bay window at end of gallery



9



10



11



12



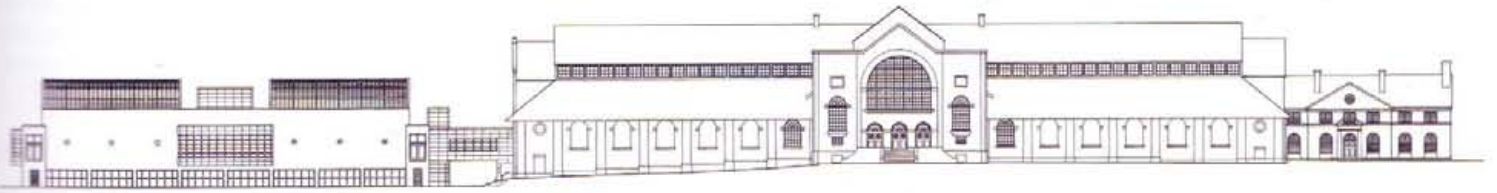

13



14

## Cornell University Buildings

All three of these campus buildings—the Basketball Arena and Fieldhouse, the College of Agriculture, and the Computer Science Theory Center at the College of Engineering—share common elements. They are larger than adjacent buildings, they address the issue of edge and define major outdoor spaces, and they establish precedents for a master plan that supports the urban constraints of each site. Constructive interaction with the user groups, the facilities planners, and the administration was essential to the realization of these projects.

The College of Agriculture building closes the quadrangle at the end of its west axis. It forms a gateway from the south campus to Bailey Plaza, which has been redefined as an outdoor pedestrian court that anchors the main campus auditorium and adjacent structures. The Basketball Arena and Fieldhouse is an addition to the hockey rink that redefines the edge of the practice fields at the center of the north campus. The Computer Science Theory Center is contextually more complex than the other two buildings, as it borders a gorge that posed significant ecological constraints. It is located on the curve of Campus Road, facing the baseball field, and is diagonally opposite the football stadium and the existing fieldhouse, the two largest structures on campus.

With the completion of the three buildings, a precedent for Cornell University architecture was realized: buildings which are site-responsive, programmatically flexible, materially dense, and scale-sensitive. In their formal articulation, contextual interaction, and use of collage, these new structures are intended to be read simultaneously as extensions and transformations.

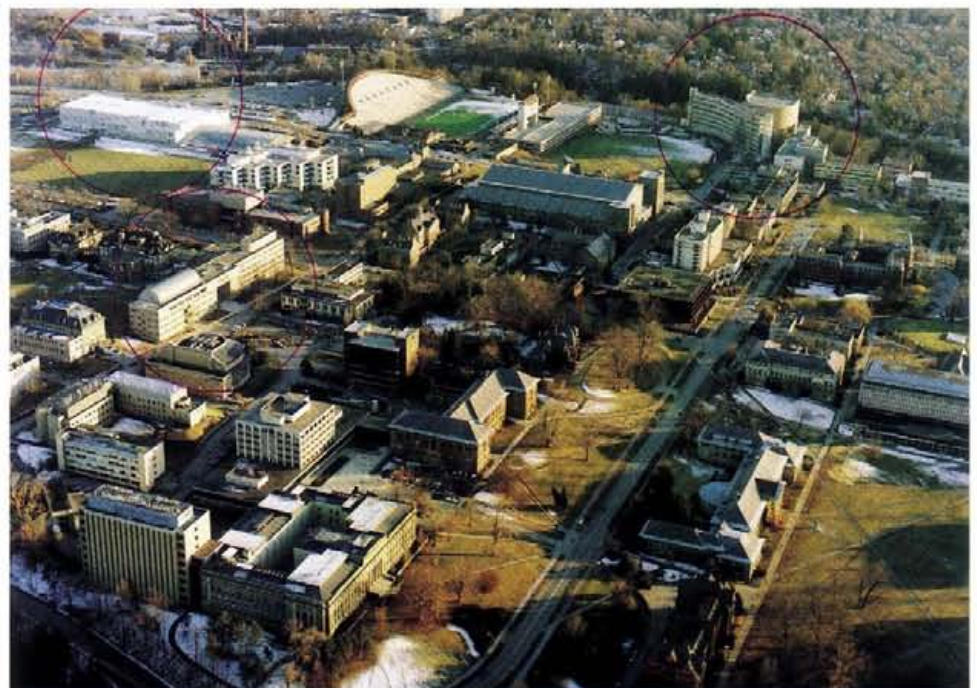
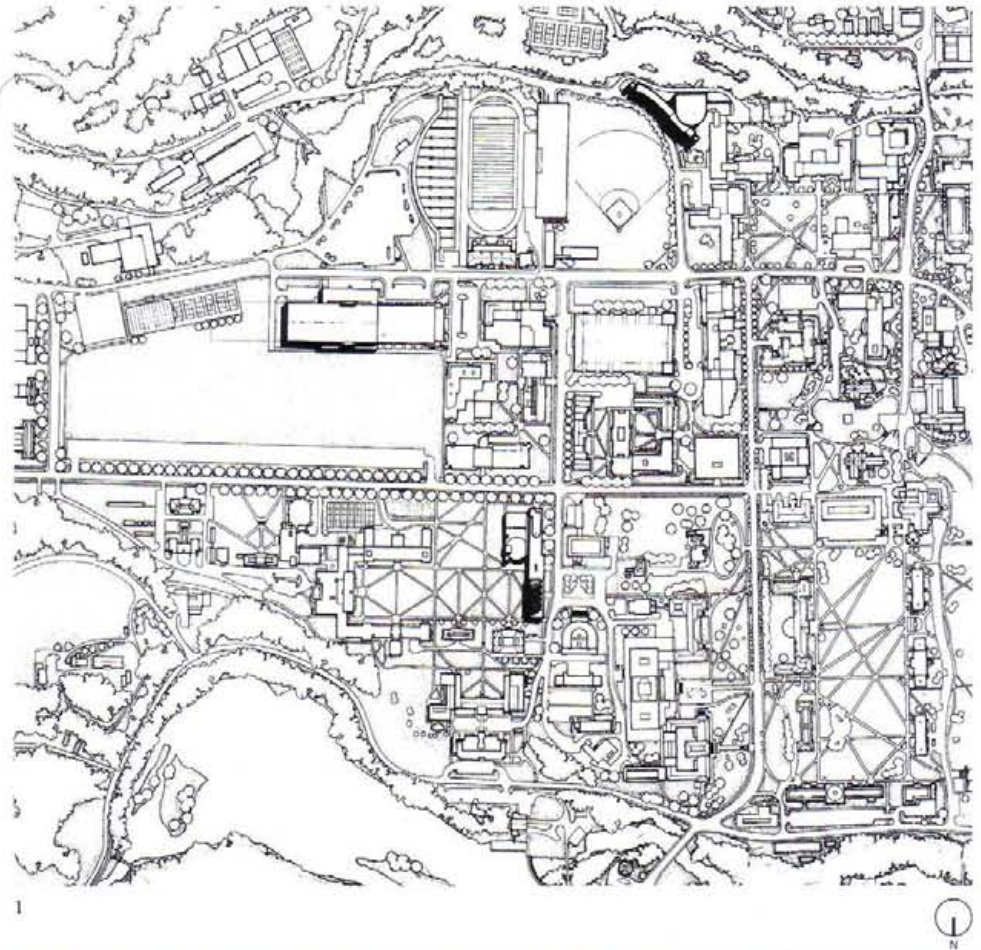

1 Site plan  
2 Aerial view

## Basketball Arena and Fieldhouse, Cornell University

Design/Completion 1985/1989

Ithaca, New York

Cornell University

180,000 square feet

Precast concrete, groundface concrete block, porcelain panels

This building forms the southern edge of Cornell's varsity practice fields. It consists of two major volumes: the basketball arena, with three regulation NCAA courts and roll-out seating for 5,000 spectators, and the fieldhouse cage.

When the two-tiered bleachers are extended, the three basketball courts merge to form a single exhibition court. A continuous balcony surrounds the space at the upper bleacher level. The court is overlooked by coaches' offices at one end and the bay window of the alumni lounge at the other. The cage is a large, naturally lit multipurpose practice space that includes a climbing wall for teaching and training.

The lobby is the organizational fulcrum of the building, linking the office service areas with the main athletics spaces and providing an interconnecting public entrance to the existing hockey rink.

Unlike the traditional campus model, the design clearly articulates the interior volumes that define the spatial, circulation, and organizational hierarchy of the building. At the same time it establishes an architectural presence from both the street and the practice fields.



1



2



3

- 1 North facade
- 2&3 Southwest facade

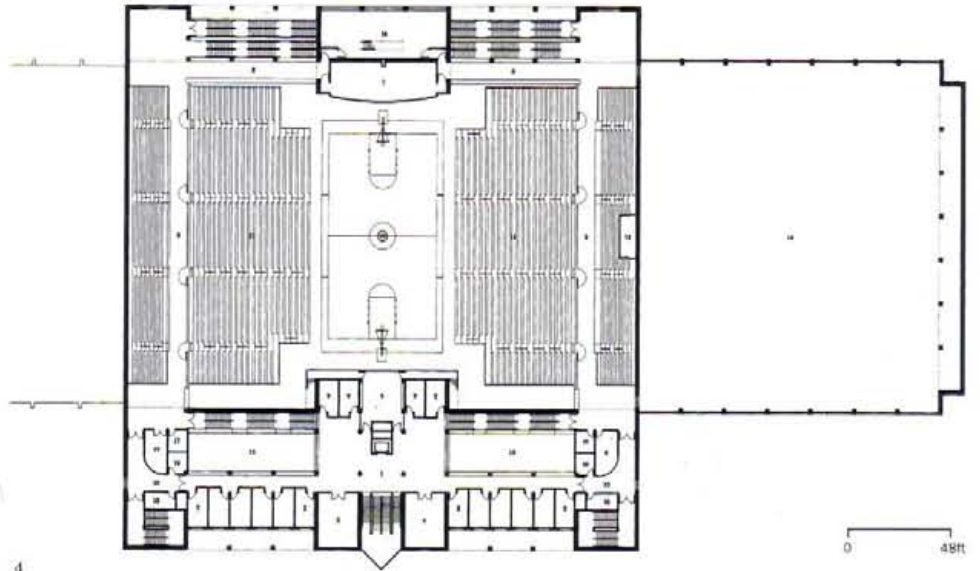

4



5

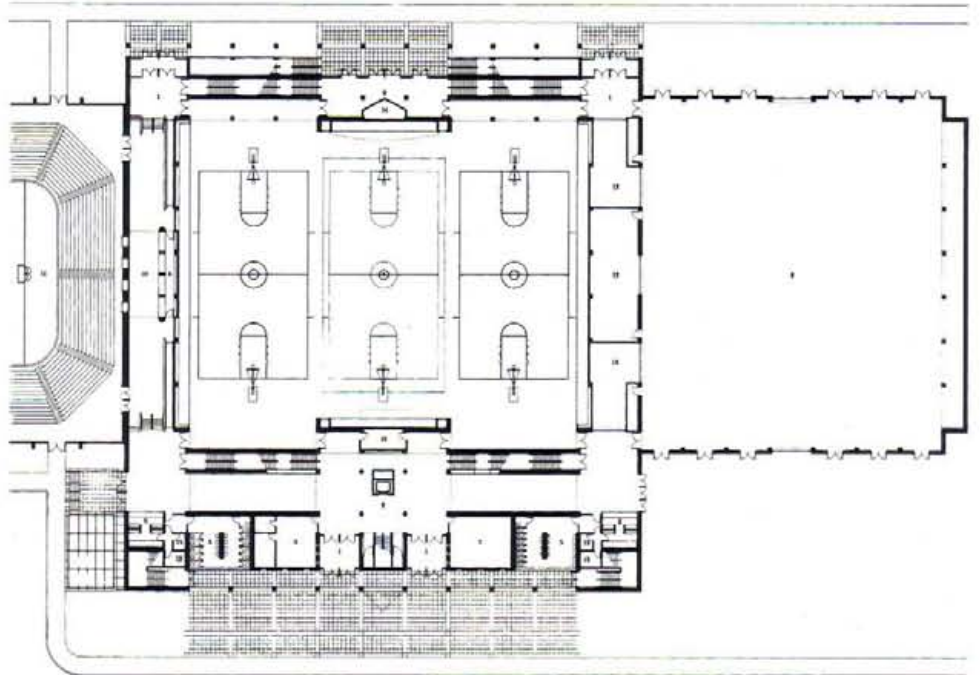

6



7



8

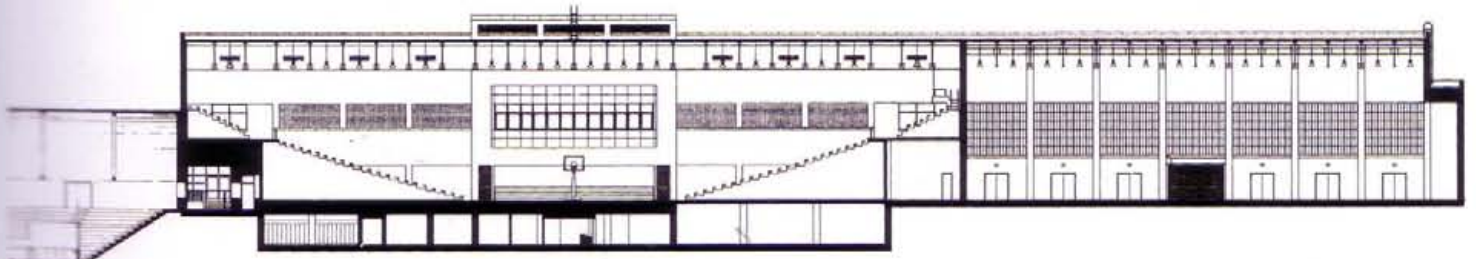

0 24ft



- 4 Second floor plan
- 5 Lobby and public stair
- 6 Entry floor plan
- 7 Entry arcade
- 8 Main stair
- 9 Longitudinal section
- 10 Basketball arena with expanding seats
- 11 Multipurpose fieldhouse cage with climbing wall

# College of Agriculture and Life Sciences, Cornell University

Design/Completion 1984/1989

Ithaca, New York

Cornell University

140,000 square feet

Steel and concrete deck, brick, cast stone, teak wood windows and doors, curtain wall

Mahogany, terrazzo, plaster

The Agriculture Quadrangle was defined by five-story masonry buildings on three sides with an open, undefined end on Bailey Plaza. The new administrative building, fronting both Bailey Plaza and the Agriculture Quad, redefines Bailey Plaza as an urban space and the quadrangle as an enclosed outdoor room.

The building accommodates administrative offices on the first three floors and the Landscape Architecture School on the fourth floor. Crowning the building is a barrel-vaulted studio space with double-height windows facing the quadrangle, and a framed roof terrace facing Bailey Plaza. A connecting bridge provides access to the Landscape Department from the academic building and frames a three-story gate to the quadrangle that recalls similar college gates on the campus.

A primary pedestrian pathway from the quadrangle to the campus gate forms one of the main entrances to the academic building; the other is at the corner of Tower Road and Garden Avenue. A two-story gallery with balcony mezzanine is the primary interior circulation spine, connecting the two entrances and providing access to classrooms, a 600-seat lecture auditorium, and a 400-seat dining facility. The third and fourth floors of the building house faculty offices and teaching support space.



1

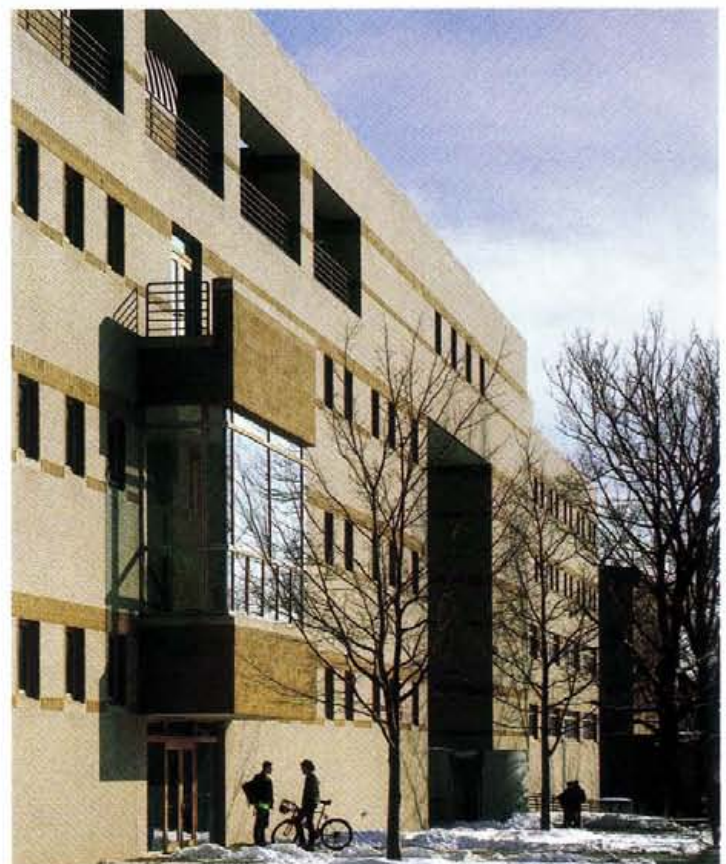

2

- 1 Entry gate from Bailey Plaza
- 2 Entry gate facade
- 3 East facade from quadrangle
- 4 Detail of entry gate
- 5 Entry to academic building from Tower Road





6



7



8

- 6 Detail
- 7 Dean's office overlooking quadrangle
- 8 Circulation gallery in academic building
- 9 Fourth level plan
- 10 Second level plan
- 11 Ground level plan
- 12 Basement level plan
- 13 Architecture studio
- 14 600-seat auditorium
- 15 Dining hall

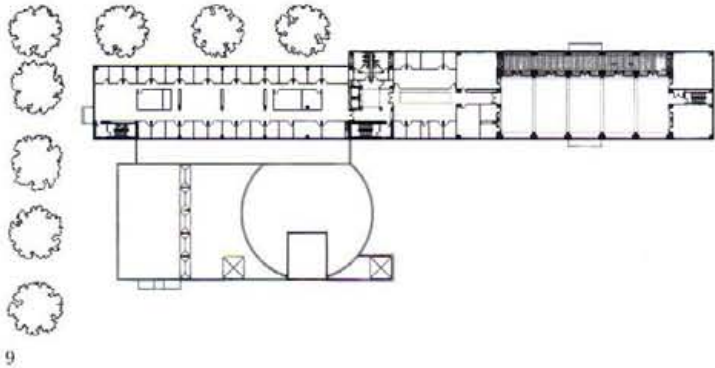

9

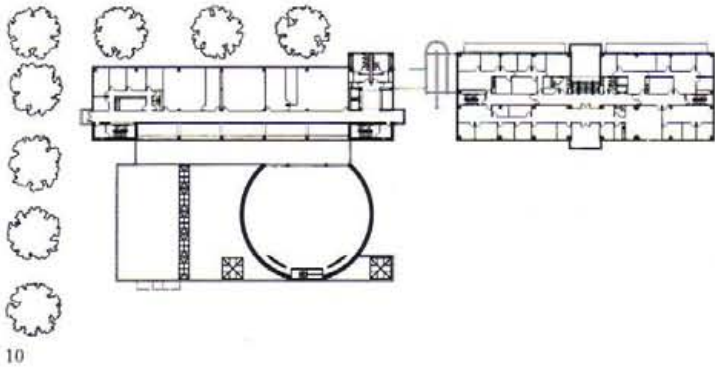

10

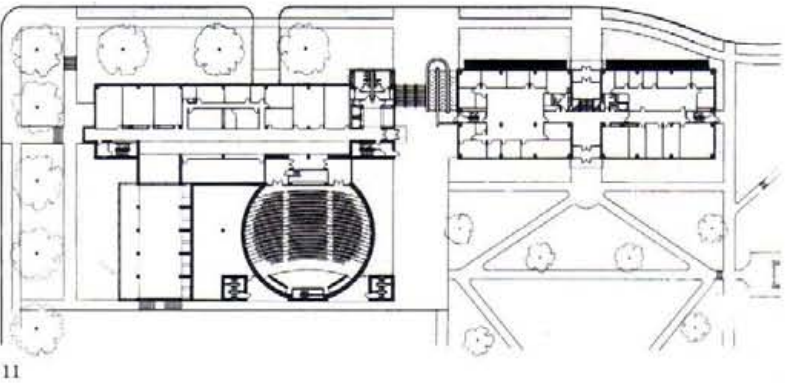

11

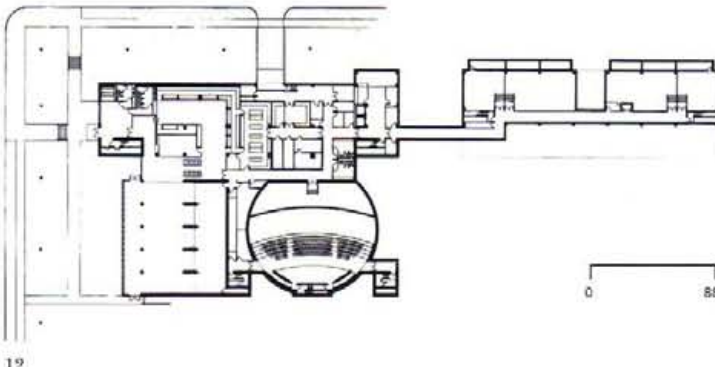

12

0 88ft





14



14



15

## Computer Science Theory Center, Cornell University

Design/Completion 1987/1990

Ithaca, New York

Cornell University

211,000 square feet

Steel and concrete deck, brick, cast stone, aluminum panels, curtain wall  
Sheltrock, raised floor, painted block

This seven-story building is organized into two elements: a 300-foot-long serpentine office building and a larger cubical mass that houses high-tech computer rooms and column-free laboratories. The intersection of the office slabs at the lab block forms the entrance and service core, which includes meeting rooms, a fifth-level sky-lobby, and a reception area for the supercomputing group.

The building is the largest structure on the Engineering campus and is connected to two existing buildings on the quad by an elevated pedestrian walkway and an underground tunnel. The generic offices on the lower floors provide flexible space for future reconfigurations to accommodate changes in electronic and computer technology.

The design responds to severe site constraints by presenting a new gateway to the campus as well as establishing a new architectural reference for the north campus.



1



2

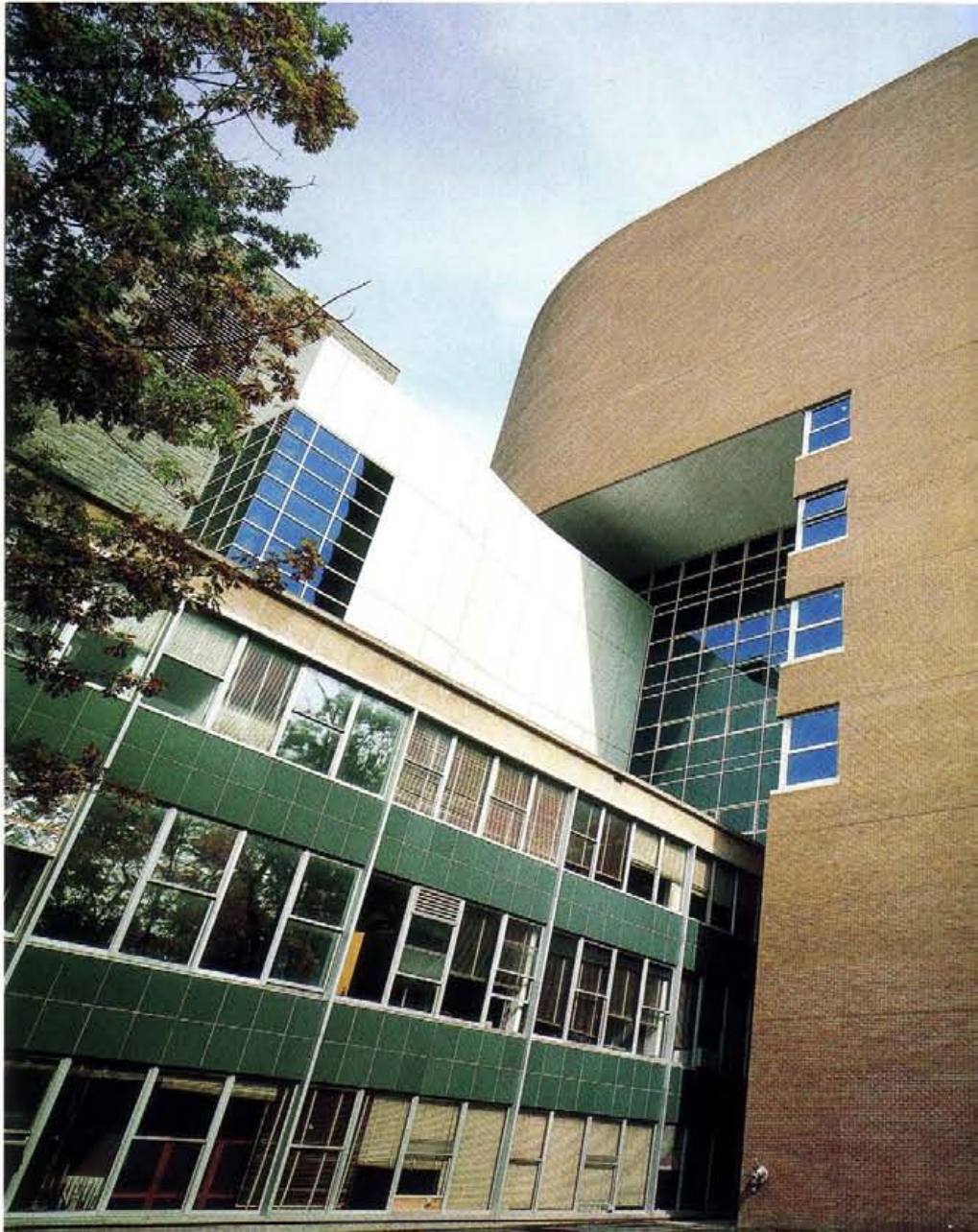

3

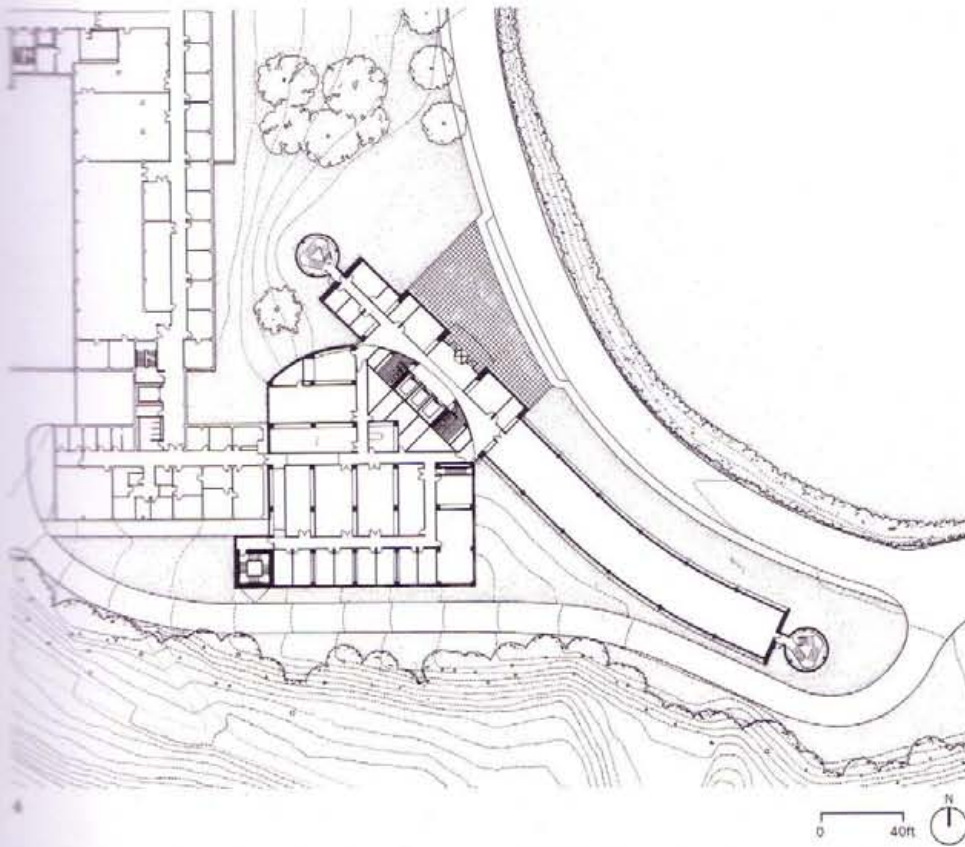

- 1 View from Barton Hall
- 2 Aerial view from Barton Hall
- 3 Laboratory building from gorge
- 4 Site plan
- 5 View of building from Campus Road



- 6 Computer classroom
- 7 Link from the new Engineering Building to the new Theory Center
- 8 Interior of stair tower
- 9 Corner detail, showing stair tower, office building, and laboratory building



6



7



8

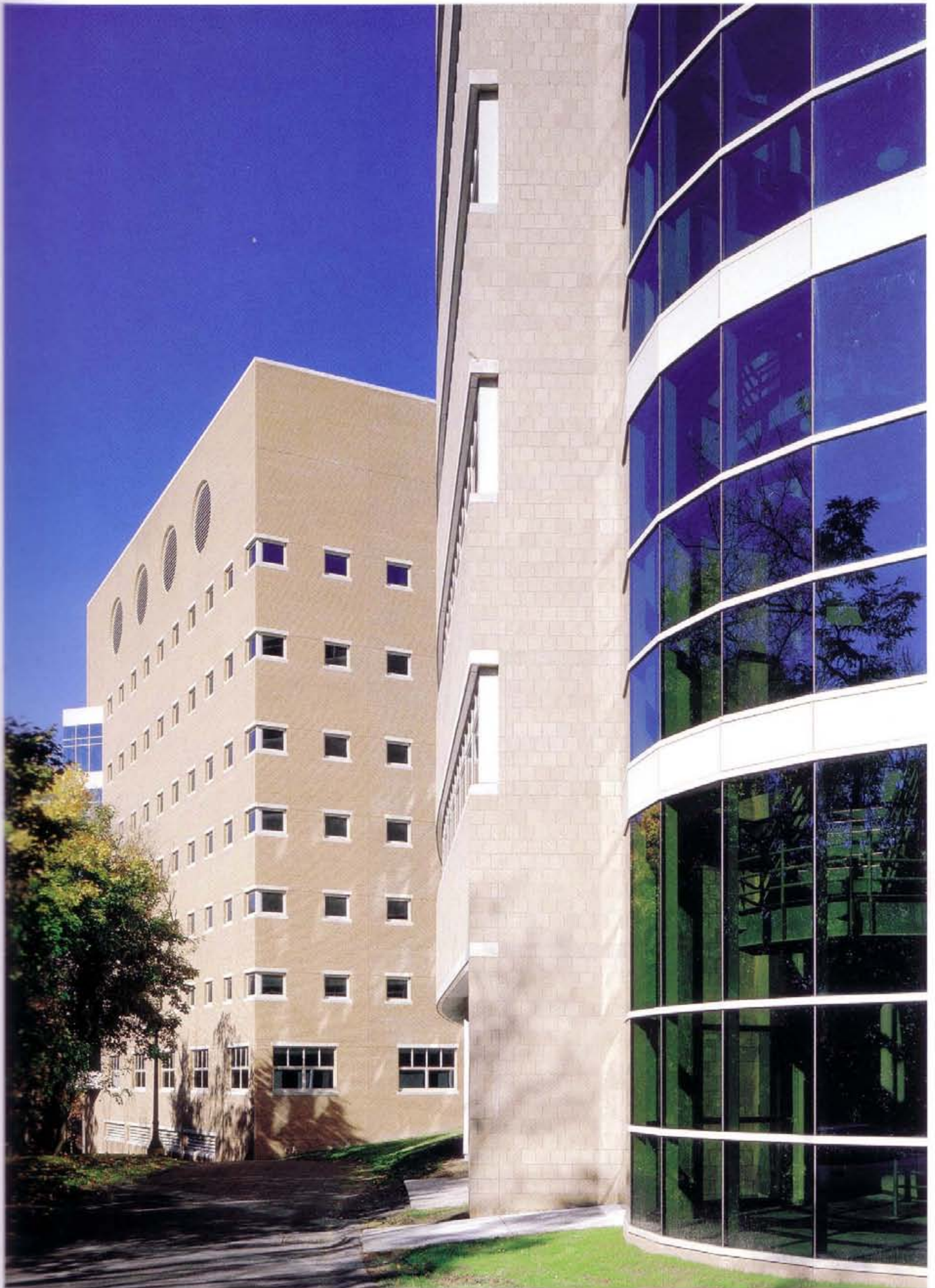

## Knoll International Showroom

Design/Completion 1983/1986

Chicago, Illinois

Knoll International

18,000 square feet

Granite, stucco, structural glass panels, painted wood, spot fixtures

This design creates a permanent yet flexible environment for ever-changing displays of furniture, objects, and fabric. The showroom's uncompromising yet restrained design retains a timeless sense of presence while focusing attention on the quality of the exhibits.

The grid derives from the dimensional module of an existing central lightwell and two rows of columns. The lightwell was transformed from a transparent void into a solid volume of white glass, creating a fixed object against which continually changing products are displayed. Defined spaces line the perimeter, leaving an open plan between the gridded glass wall and the central white glass object. A suspended ceiling grid of painted wood accommodates multiple lighting sources and hangings, and maintains a unified but flexible visual plane over the entire space.

In addition to display space, the showroom accommodates staff offices, a kitchen, and storage, as well as a multi-use video presentation space.

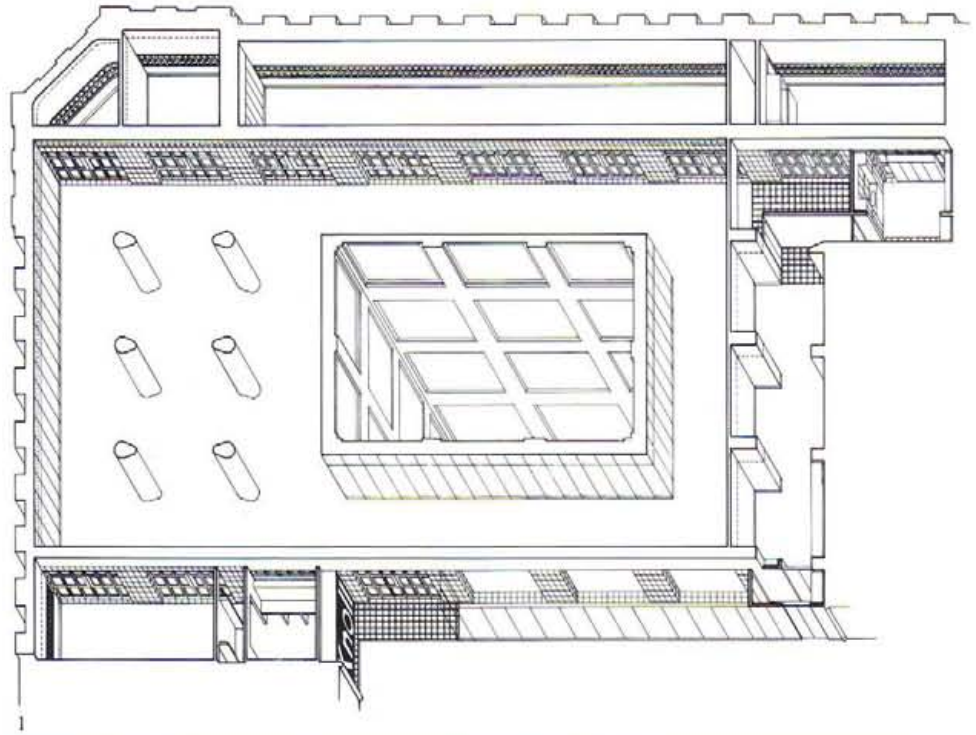

- 1 Axonometric  
2 Entry from public gallery  
Opposite:  
Showroom from entry





4



5



6



7





5



9

- 4 Showroom
- 5&6 Views of showrooms
- 7 Office interior showing panel wall
- 8 Typical office space
- 9 Conference room

## IBM Corporation Office Building and Distribution Center

Design/Completion 1985/1987

Greensboro, North Carolina

IBM Corporation

150,000 square feet

Concrete, clear spandrel and frosted glass, glass block, ceramic tiles, porcelain panels

Located adjacent to a main highway, the building is organized to accommodate five floors of flexible office space. Expansion of the original structure is provided in two phases to the east and west.

The glass on the southern side is recessed behind the exposed concrete structure, creating an integrated sunscreen which redefines the sculptured facade. The entrance to the building is through the tower element, which contains a five-story atrium and the elevator system. Access to each floor is from a balcony overlooking the atrium with views to downtown Greensboro.

On the north, the glass is flush with the floor edge to create an opposite facade reading. Three types of glass—clear, spandrel, and frosted—are used to articulate floor, sill, and suspended ceiling data.

In contrast to the exposed concrete frame, the entrance tower is clad in white tiles, glass blocks, and white porcelain panels. The tower element is in counterpoint to the object/frame reading of the main structure, and also redefines the entry plaza and the landscape between building and parking area.

Using basic construction technology, this generic building type is transformed by innovative planning, structural clarity, and the use of integrated sunscreens that provide both environmental control and facade articulation.



1

- 1 Detail of metal grating between brise-soleil and glass window wall
- 2 Site plan
- 3 View of building from southwest
- 4 Night view of entry plaza lobby
- 5 Entry plaza to lobby

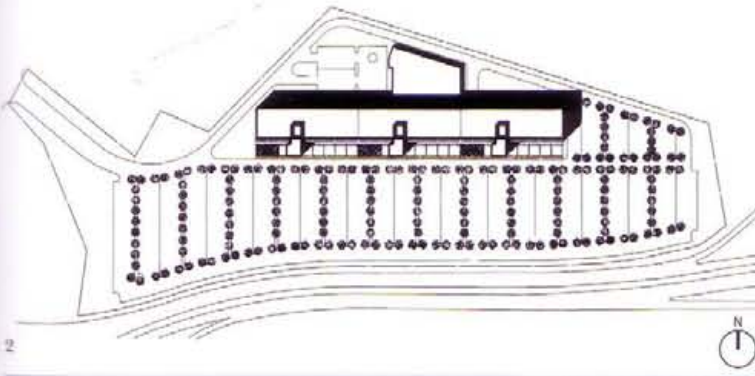

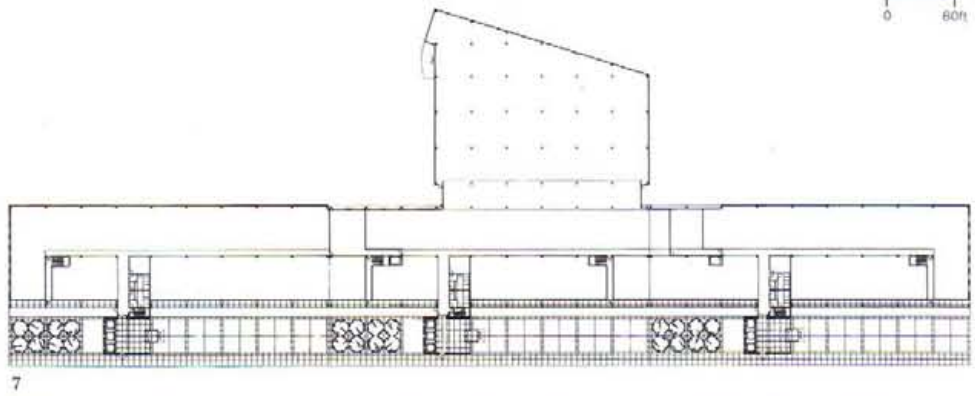
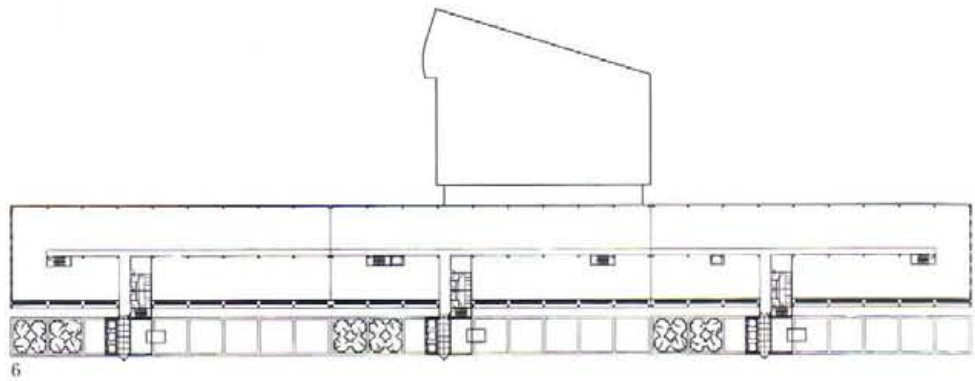

- 6 Typical floor plan
- 7 Ground floor plan
- 8 Porthole view from elevator stops
- 9 Lobby detail
- 10 View of typical elevator bridge
- 11 View from typical elevator bridge through lobby

8



10



51

## East Academic Complex, Eugenio Maria de Hostos Community College

Design/Completion 1985/1994

Bronx, New York

City University of New York

240,000 square feet

Banded brick, white porcelain panels, glass, glass block, Kalwall, painted plaster, ceramic tiles, terrazzo

This multipurpose building for a community college in a Spanish-speaking area of the Bronx represents a composite program located in a dense urban context. The building program provides for classrooms, faculty and student offices, a swimming pool, a gymnasium and ancillary athletics spaces, a 1,200-seat proscenium theater, a 350-seat repertory theater, faculty and student dining facilities, a campus store, an art gallery and studios, and a pedestrian bridge linking existing campus buildings to the new structure.

The Grand Concourse facade reinforces the built edge, establishes a gateway to the college, and, together with the original campus structure, defines an outdoor courtyard. The new tower and bridge serve as visual icons, establishing a sense of place and a new image for the campus and the community.

The building contains many departments with diverse and varied functions. As a unifying design strategy, it is organized around a five-story skylit atrium. Articulated horizontally with balconies and vertically with stairs, the atrium is the major public space on the campus. It is the primary internal circulation volume of the new building as well as providing lobby space for the repertory and proscenium theaters and access to the bridge.

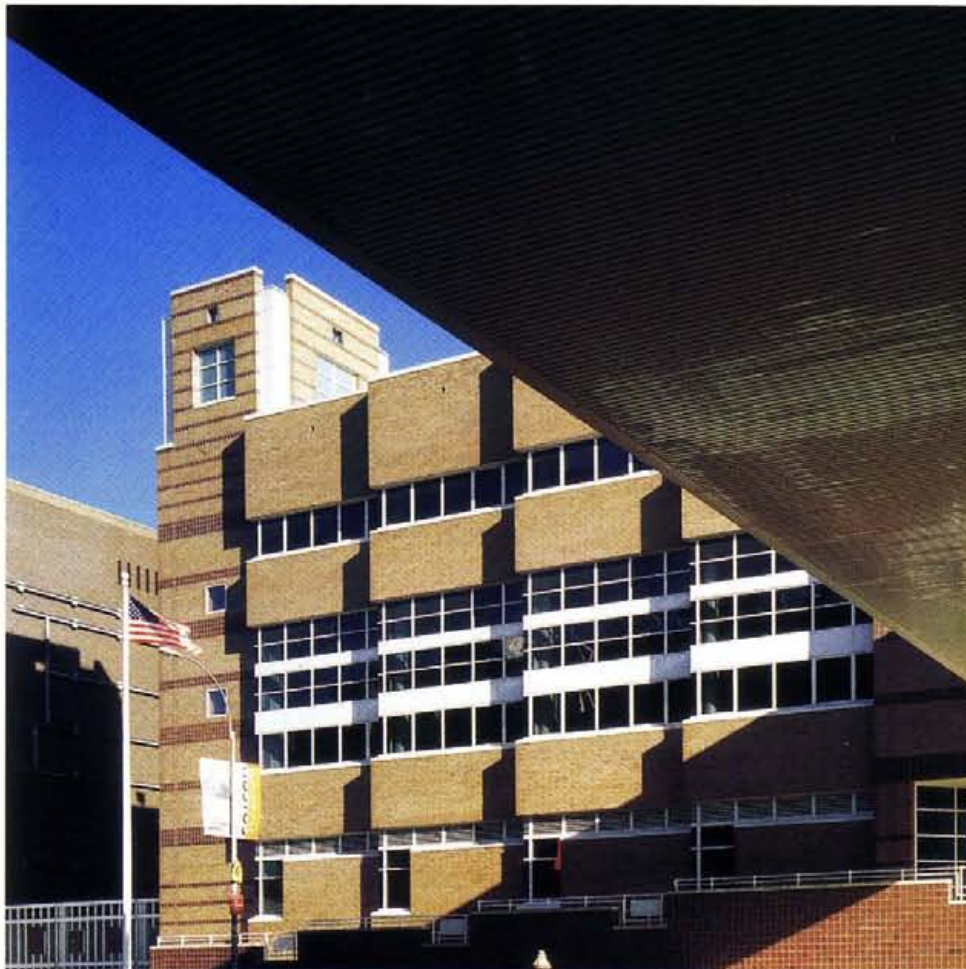

- 1 View across Grand Concourse to the East Academic Complex
- 2 East Academic Complex and pedestrian bridge
- 3 Tower viewed from pedestrian bridge
- 4 Entry level plan
- 5 View of atrium from walkways
- 6 Atrium walkways
- 7 Main atrium

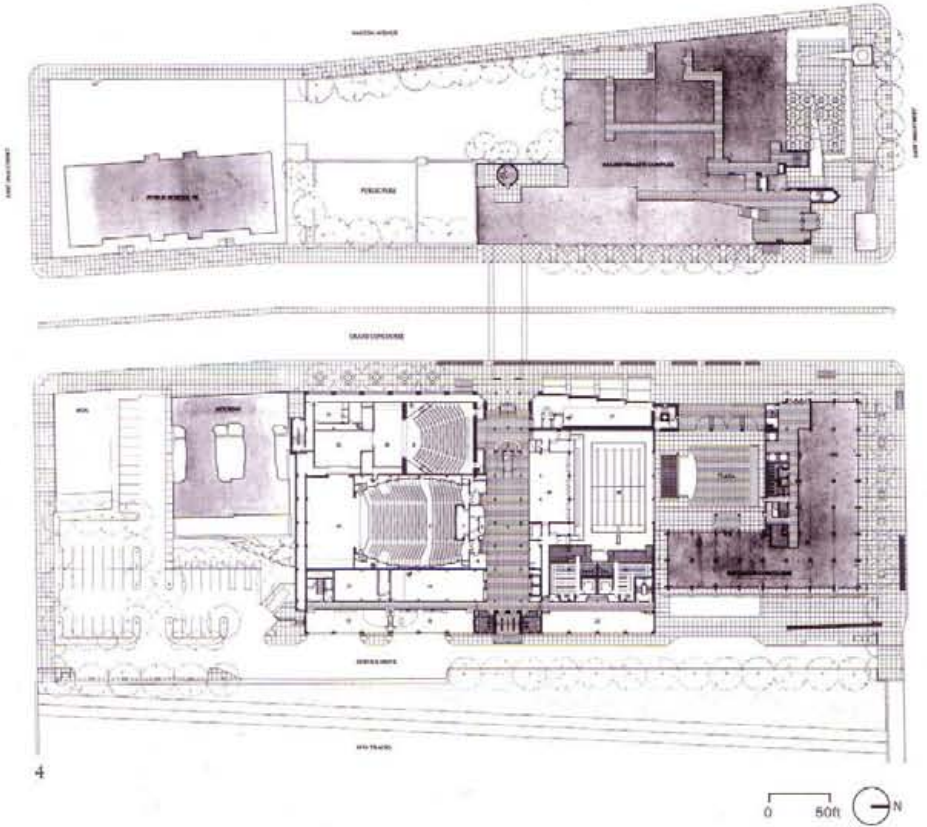

5

7

- 8 Cafeteria with view of the bridge
- 9 Art gallery overlooking the Grand Concourse and entry ramp
- 10 Pedestrian bridge
- 11 Stairwell extension behind east facade
- 12 North-south section
- 13 Main theater featuring articulated walls and ceilings
- 14&15 Repertory theater with exposed catwalks and adjustable lighting grid

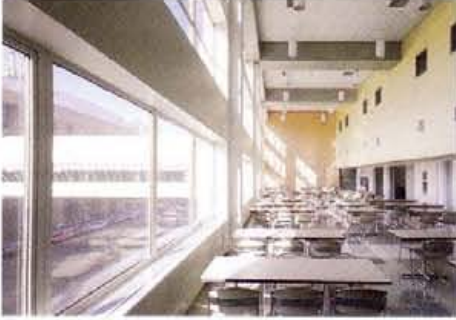

8



9



10



11



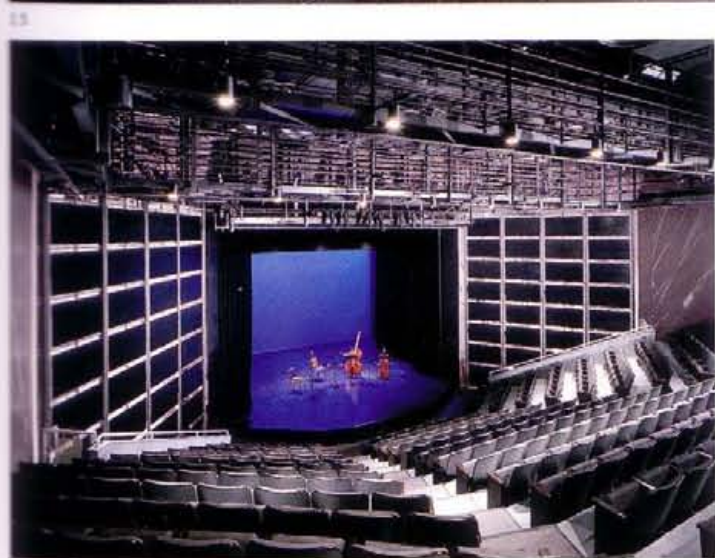
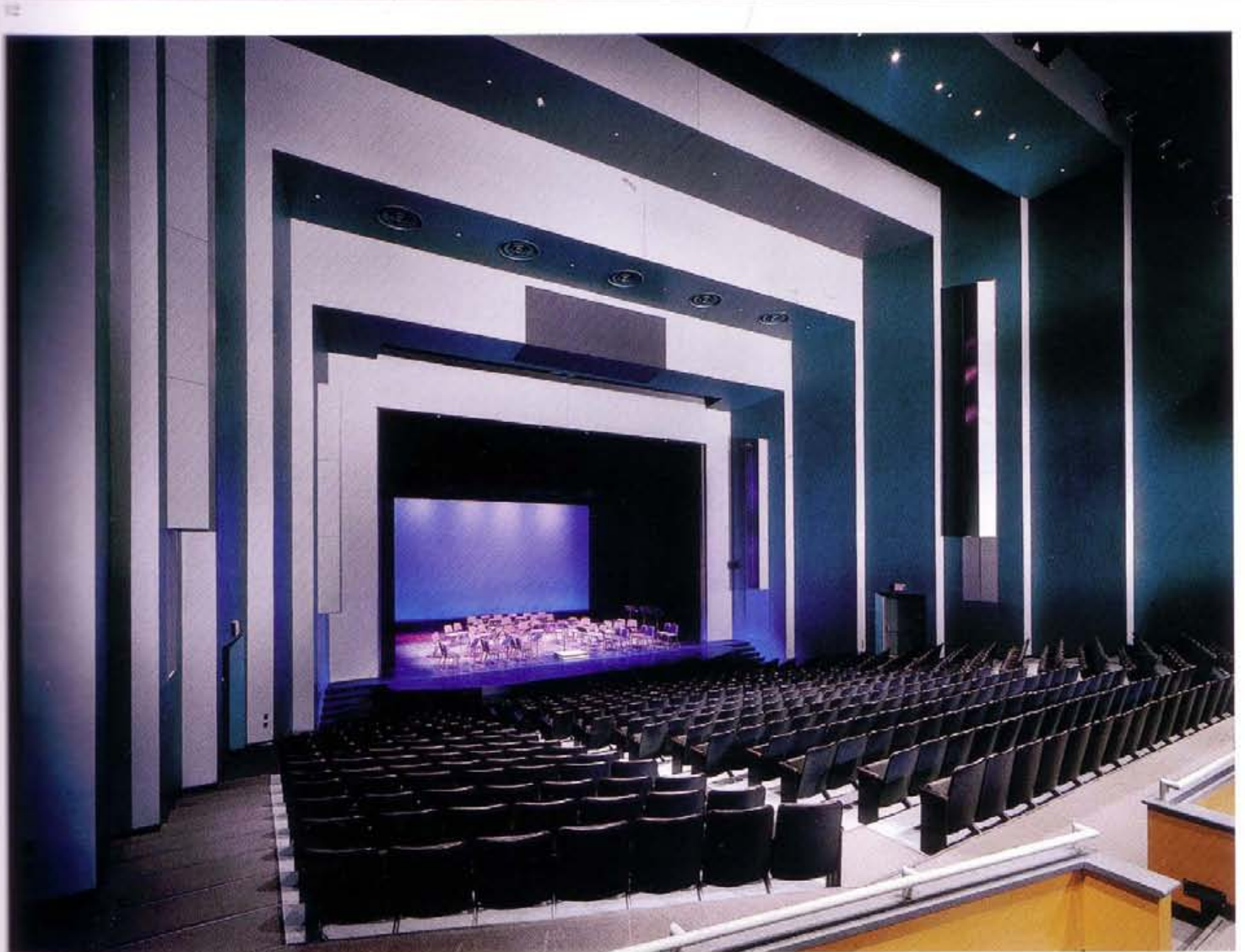
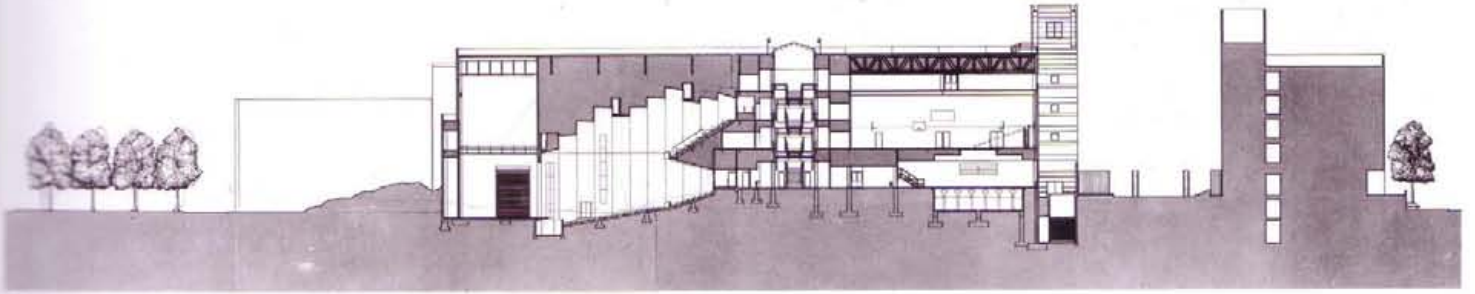

14

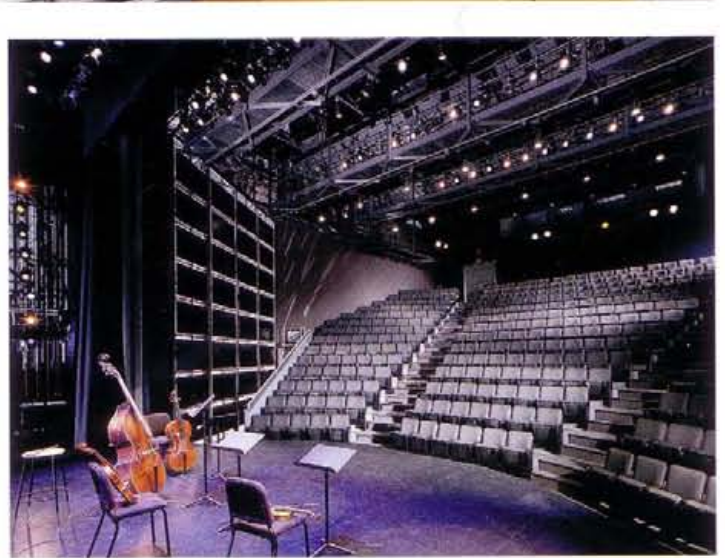

15

## Morgan Stanley & Co. Inc., World Headquarters

Design/Completion 1985/1990

New York, New York

Morgan Stanley & Co. Inc.

1,300,000 square feet

Blue-green, white-patterned, and mirrored glass; silver-gray metallic painted aluminum panels; polished stainless steel; green marble; black and white granite; anigre wood panels and coffered ceilings

This tower is located in the Times Square area of midtown Manhattan. The diagonal, stepped base responds to the pedestrian scale of the street in the theater district. The segmented curve of the double-height mechanical floor signals the transition from the diagonal base to the orthogonal tower, which refers to the city grid. The building's articulated top creates a strong silhouette on the Manhattan skyline.

The curtain wall facade is composed of layers of glass and metal panels which give multiple readings of opacity and reflectivity with changes in the natural light.

Three levels of building signage respond to the zoning requirements of Times Square: at pedestrian level there are individual retail signs for each storefront; above these are 10 vertical, cantilevered fins in black glass which collectively spell "1585 B'way;" finally, above the first building setback, three horizontally scrolling electronic message boards carry stock market quotations and financial news. Large video panels, situated at each side street, display images and text towards upper Broadway and lower Times Square.

In 1995 the entry lobby was redesigned to provide for a new cafeteria below grade. The original floor plate was adapted to accommodate two sets of escalators, accessed from either side by a connecting bridge. The bridge offers views across the lobby through a curved glass wall, and below to the cafeteria area.

The 40th and 41st executive floors were also designed in 1995. They are connected by a double-height entry space which affords panoramic views over Manhattan and reads as a referential volume for the two floors.

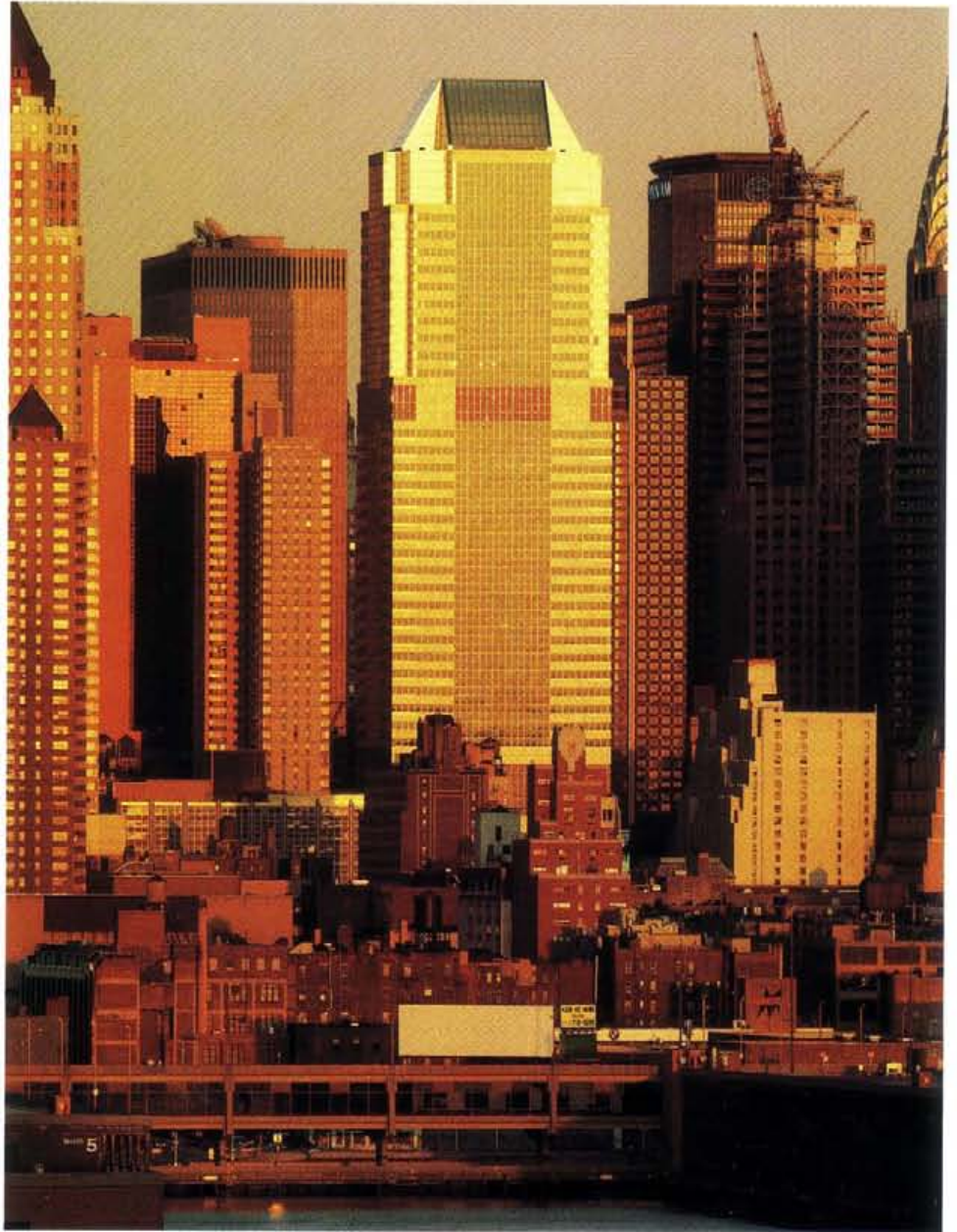

- 1 View from New Jersey looking east across the Hudson River
- 2 Detail of building signage from Times Square
- 3 Pedestrian passage and auto drop-off
- 4 Main lobby



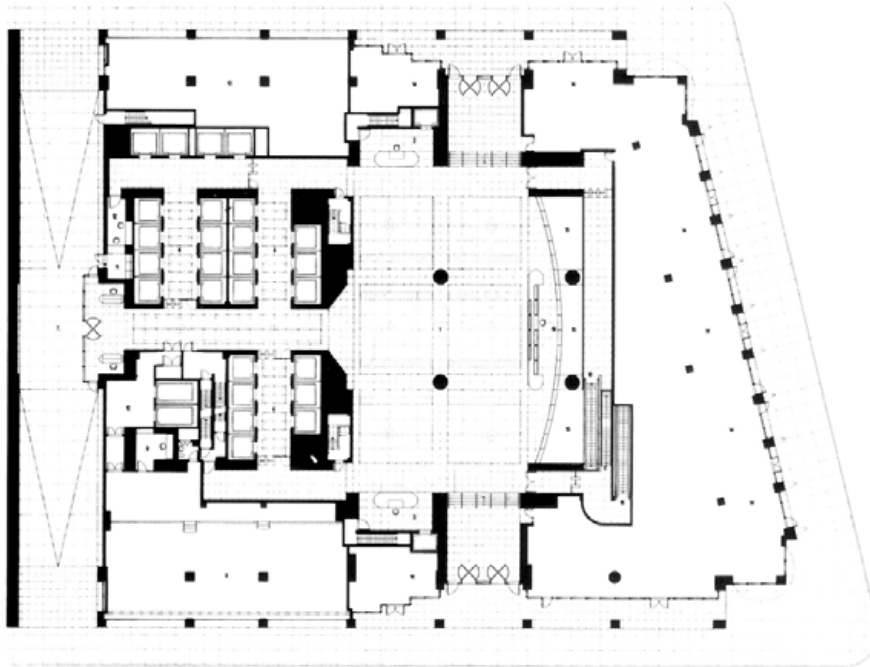

5

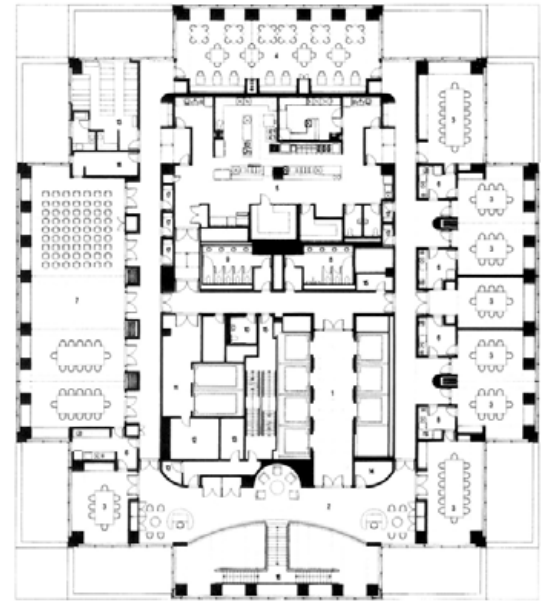

6

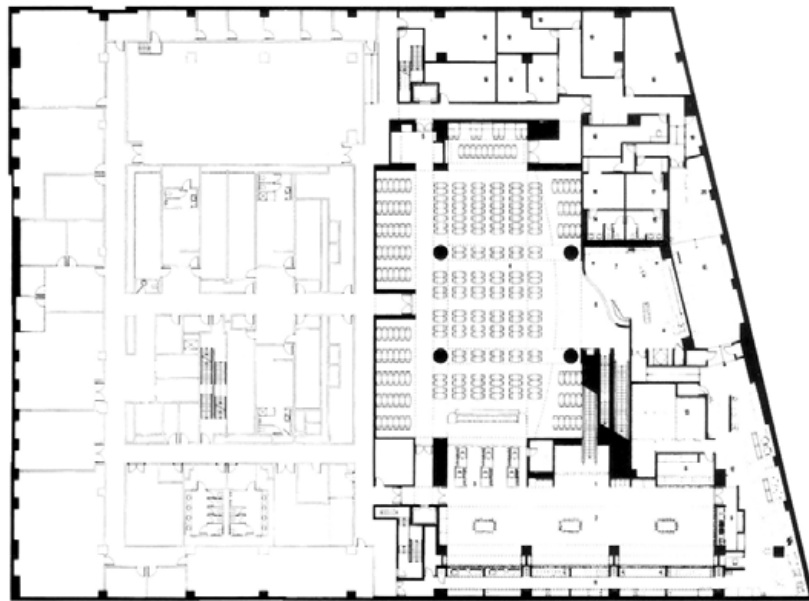

7

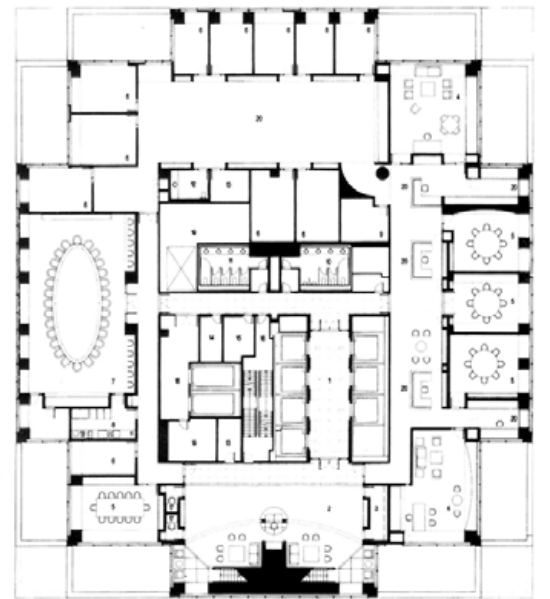

8



5



10



11



12

- 5 Lobby level floor plan
- 6 41st level floor plan
- 7 Lower level/cafeteria floor plan
- 8 40th level floor plan
- 9 Skylit arcade between main lobby and auto drop-off
- 10 Main lobby and cafeteria
- 11 Main cafeteria at basement level
- 12 Exit from cafeteria

## Center for the Arts, State University of New York at Buffalo

Design/Completion 1985/1992

Amherst, New York

State University Construction Fund

264,000 square feet

Three colors of brick, painted white panels, white painted aluminum doors and windows, Kalwall

Terrazzo floors and stairs at public areas, drywall, acoustic tiles, painted metal doors and frames

The Center for the Arts is situated on the last open site at the State University of New York at Buffalo. Located at the end of the primary cross-axis of the campus, overlooking Lake LaSalle, the building redefines Coventry Circle as a major entry plaza for both athletics and performing arts events.

The building is asymmetrically bisected by a two-story skylit gallery that defines the north-south axis and connects the Fine Arts and Theater Arts departments. The Fine Arts Department consists of a student/faculty art gallery; sculpture, photography, drawing, and painting studios; and administrative and faculty offices.

The Theater Arts Department is larger, with an 1,800-seat full proscenium concert/opera theater, a 400-seat repertory theater, two rehearsal theaters, a screening room, a media department and studio, two dance studios, a full-service backstage area, and miscellaneous support spaces.

The art studios and performance spaces were designed to provide maximum flexibility for students and faculty. The combination of the two disciplines into a single building adds a programmatic and cultural dynamic to the center of the campus, increasing student and public access to the university's multidisciplinary activities.

To break down the scale, articulate the massing, and integrate the building into the existing context, horizontally banded brick of three colors and sizes is used as the primary exterior material, creating a counterpoint to the white painted aluminum panels that define the public volumes, circulation spaces, and stage houses.

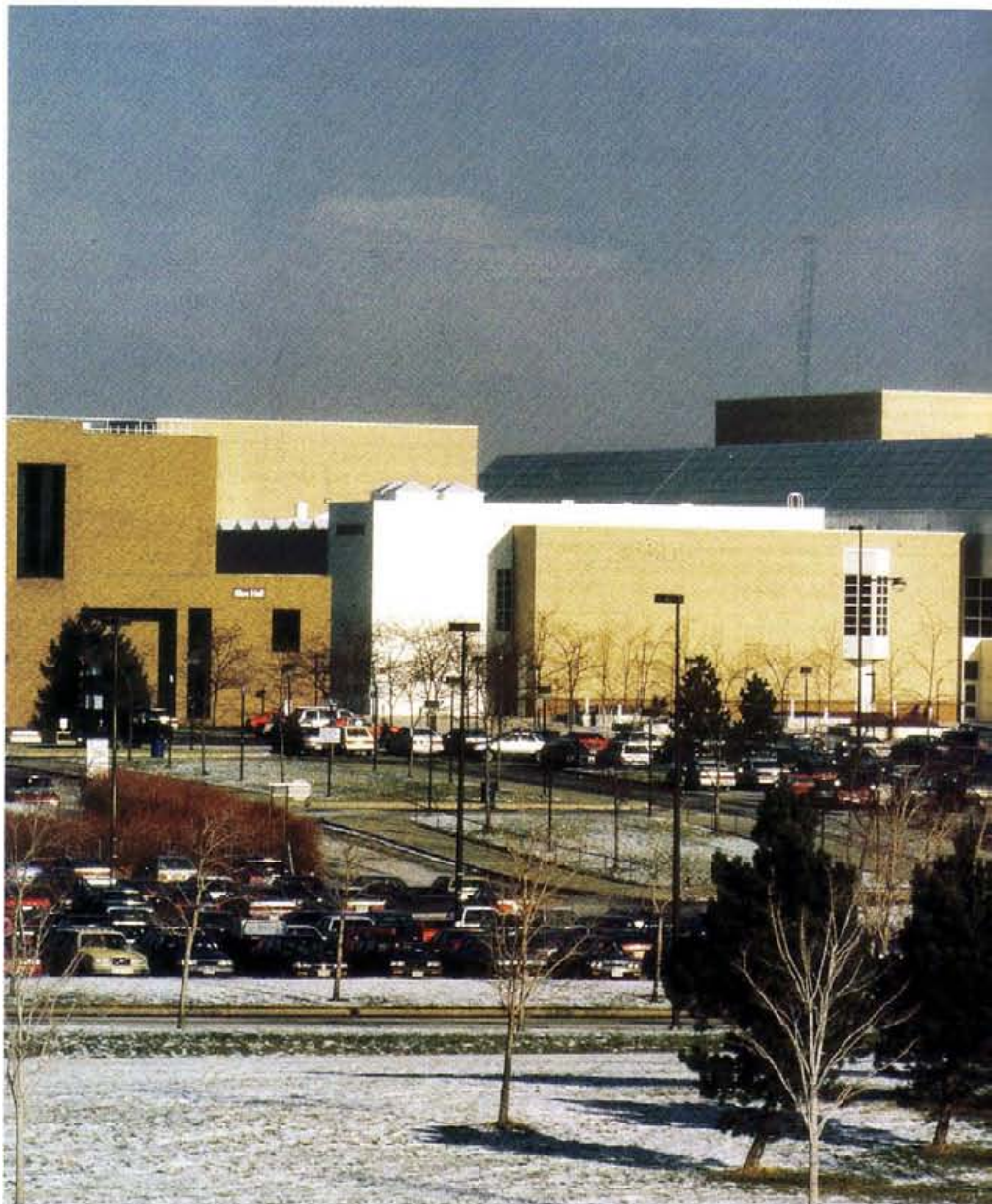
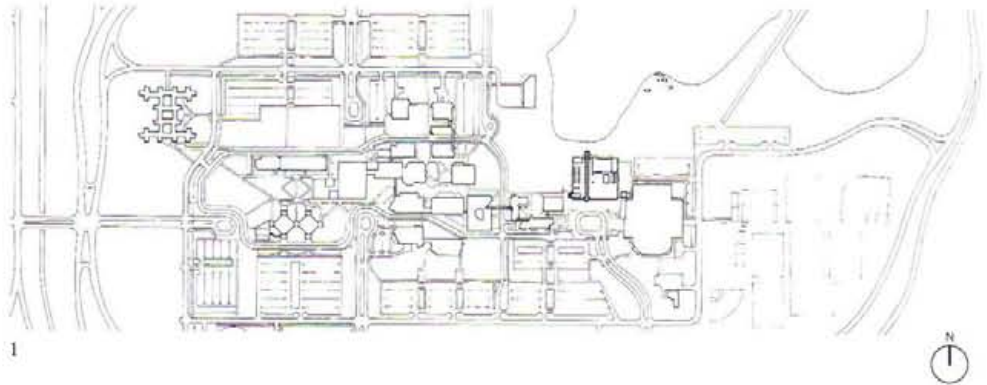

- 1 Site plan
- 2 View of public entrance and south facade from Coventry Circle
- 3 View of north facade overlooking Lake LaSalle
- 4 Detail of south facade
- 5 University art gallery seen from Coventry Circle



3



4



5



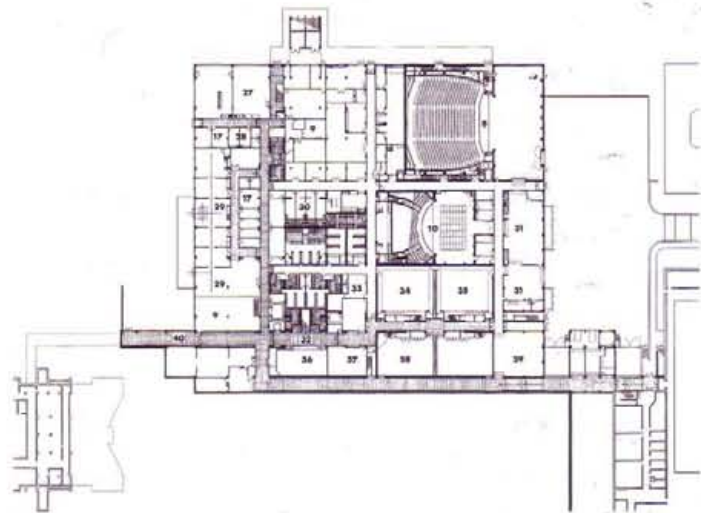

6

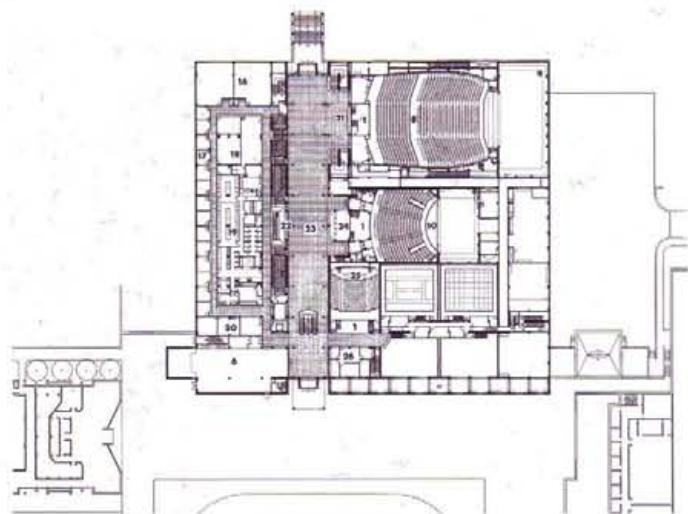

7

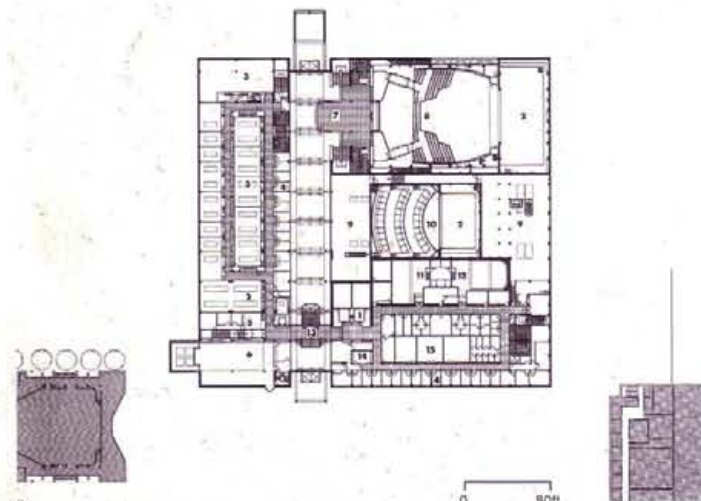

8



9



10



11



12



13





- 6 Lower floor plan
- 7 Entry floor plan
- 8 Upper floor plan
- 9 Orchestra and balcony lobbies by day
- 10 Atrium by night
- 11 Atrium by day
- 12 Atrium from balcony lobby
- 13 Dance studio with control room and balcony overlooking dance floor
- 14 400-seat drama theater
- 15 View from the stage of the main theater

14



15

## Thomas I. Storrs Architecture Building, University of North Carolina at Charlotte

Design/Completion 1986/1989

Charlotte, North Carolina

University of North Carolina

83,000 square feet

Steel frame structure with masonry walls, groundfaced concrete block, brick, glazed tiles, Kalwall, aluminum windows and doors

The College of Architecture is the first building to be constructed on the perimeter of the campus, originally designed in the 1960s.

Sited on a former parking lot, the development set a precedent for the design of outdoor spaces between campus buildings and resolved the previously undefined campus circulation system by introducing a parking strategy that uses perimeter garages as transfer nodes or gateways into the campus.

The building is organized around a linear, two-story, skylit circulation and exhibition courtyard. It is defined by an open stair and elevator tower at the entry, and by a grandstand stair at the student lounge/lecture theater end. The courtyard entry terminates a major campus circulation axis and admits passage to the multi-use exhibition gallery, a 200-seat lecture theater, and administrative offices. Seminar rooms and faculty offices flank the exhibition court, and parallel studios and shops that line the exterior facades.

The detail, use of materials, and expression of construction technologies reinforce the building's function as a learning and teaching laboratory for the study of architecture.

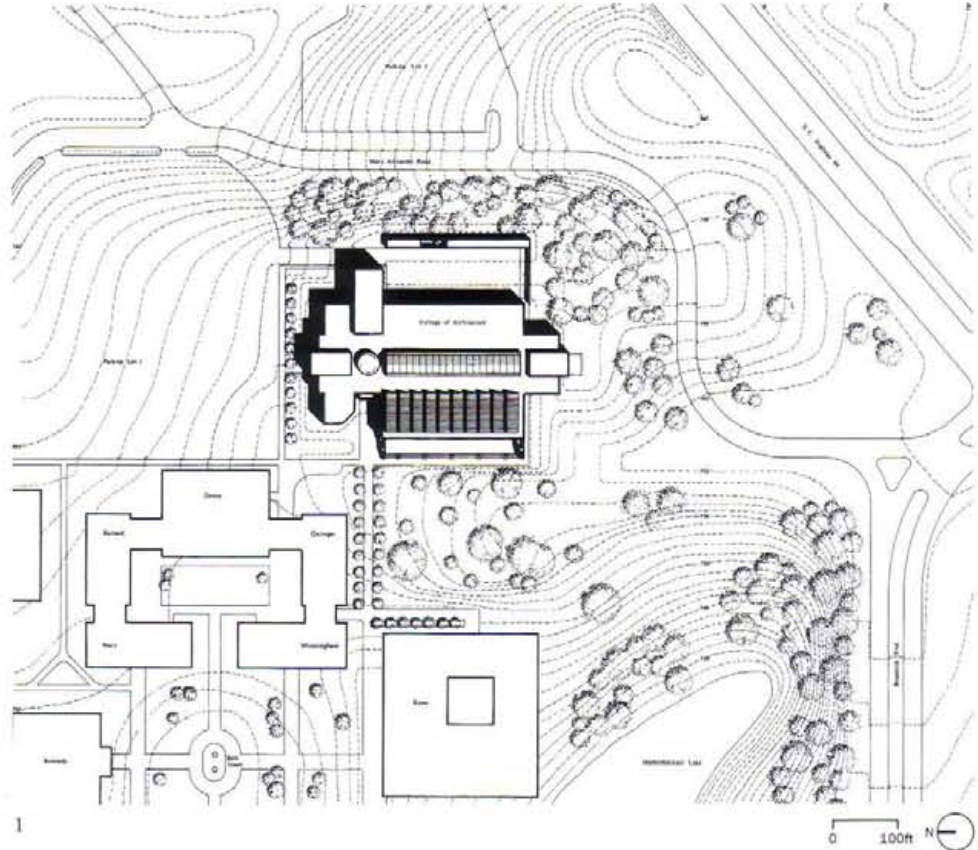



- 1 Site plan
- 2 Entry courtyard
- 3 View of building from northwest corner
- 4 Southwest facade from pedestrian walk

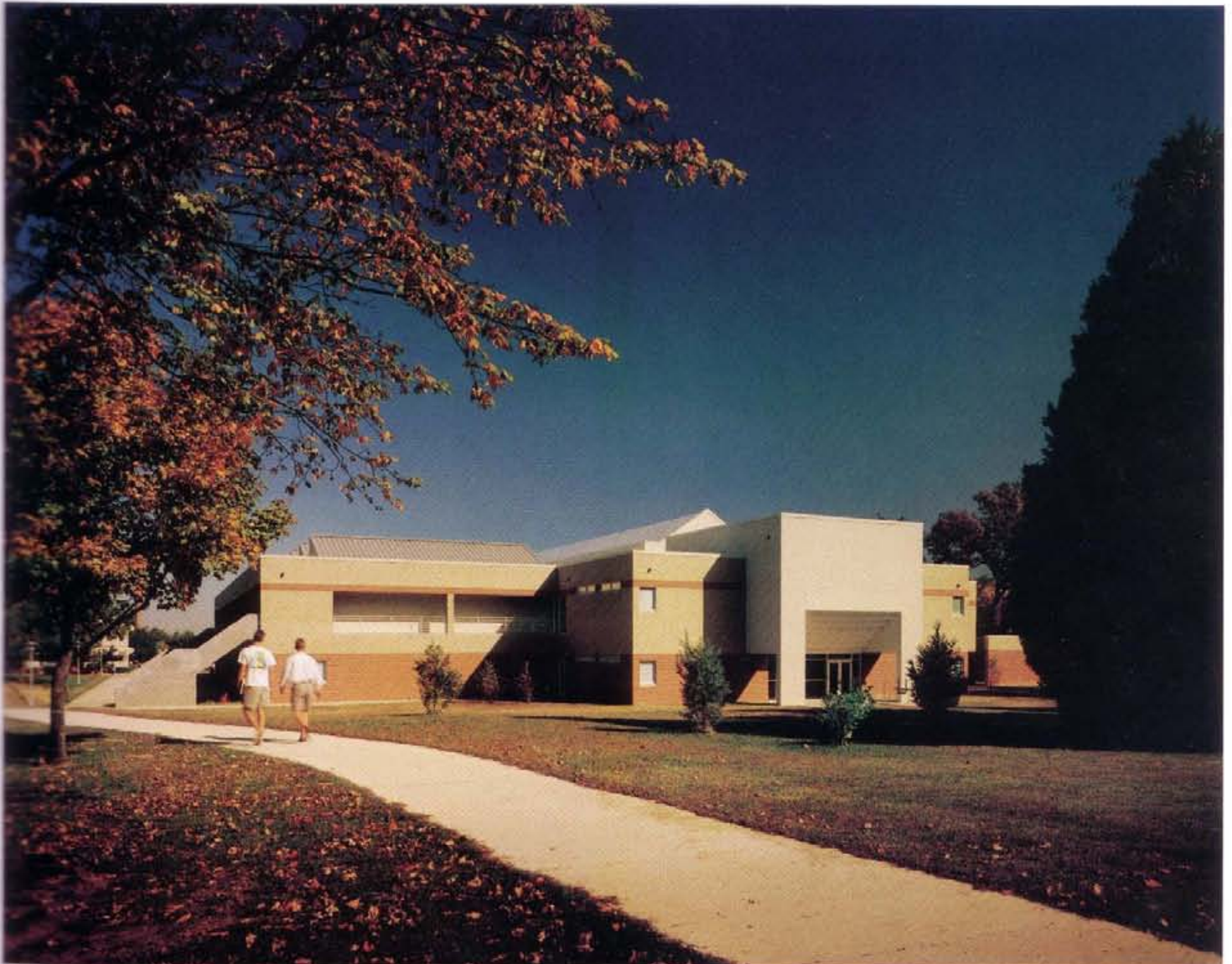

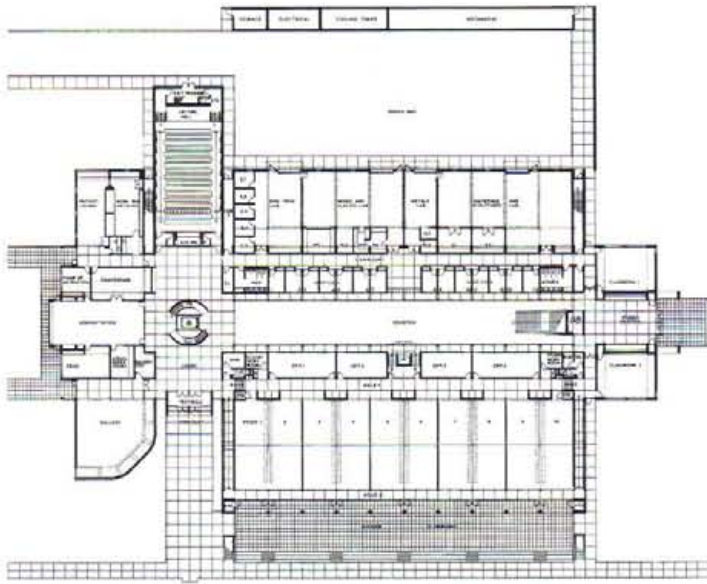

5

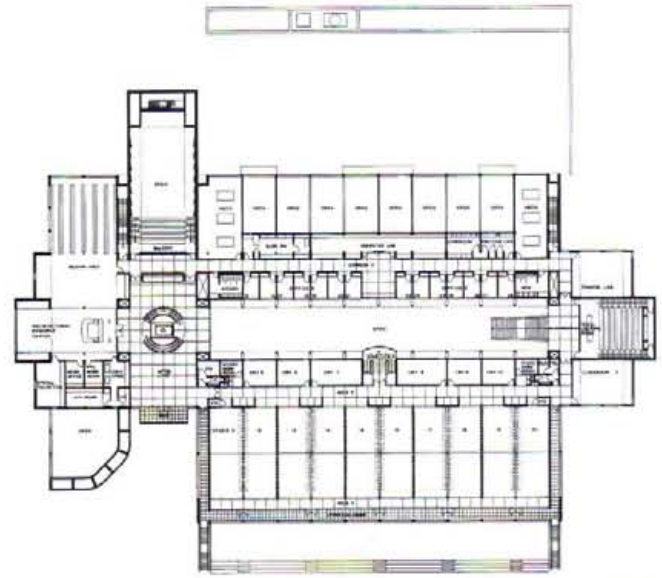

6

0 40ft



7

- 3 Ground floor plan
- 4 Second floor plan
- 7 Exhibition hall
- 8 Lecture theater
- 9 Main exhibition gallery
- 10 Second level architecture studio
- 11 Detail of public stair from entrance hall



9



11

## International Design Centers I & II

Design/Completion 1985/1987

Long Island City, New York

Lazard Development Corporation

1,000,000 square feet

Concrete frame, brick walls

Kalwall panels, skylights, steel pipe, trussed catwalks, adjustable lighting

The International Design Center is a complex of four typical reinforced-concrete loft buildings of World War I vintage. Buildings I and II were renovated into design centers for the furniture and textile industries.

Center II was a seven-story building with an open courtyard. A trussed bridge at the open end of the plan provided the opportunity to create two major spaces: a skylit interior courtyard and an open entry court with an elevator core and lobby. A new catwalk beam for exterior lighting and display unifies the entry facade and acts as a gateway to the complex.

A decorative stair was added at the north end of the Center II atrium. Four new steel bridges span the atrium at the fourth floor level, vertically articulating the space and forming an implied second ceiling. A translucent skylight transforms the once open courtyard into a public room that orients the continuous open-balcony galleries adjoining the showroom spaces on each floor.

Center I, completed after Center II, is a horizontal five-story building organized along the same principles. The courtyard was enclosed to create a central atrium surrounded by showrooms. A cascading double stair was added to one side of the space, connecting all balcony levels with a central exposed elevator bridge. The Center I building is entered from a recessed arcade facing the Center II parking plaza, or from a ramped connecting bridge at levels three, four, and five. Spanning the street with its red metal and oculus fenestration, the 80-foot bridge is the project's graphic symbol.



2

- 1 Aerial view looking towards Manhattan
- 2 Center I and bridge detail
- 3 Section through Center II and Center I
- 4 Detail of facade entry
- 5 Bridge from Center II to Center I

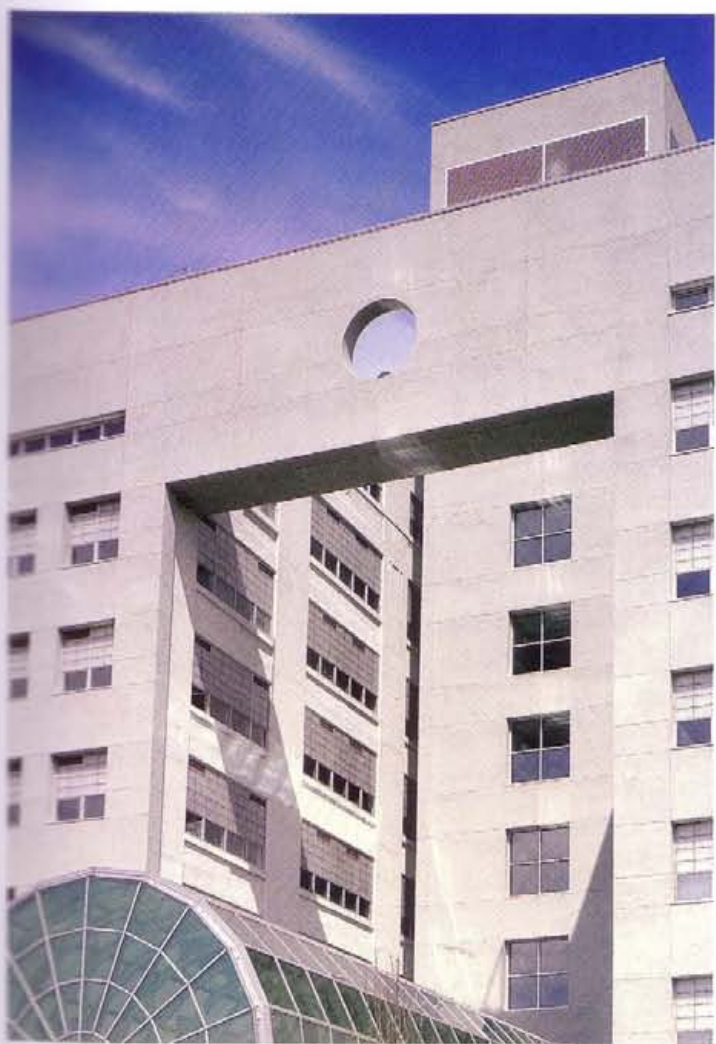
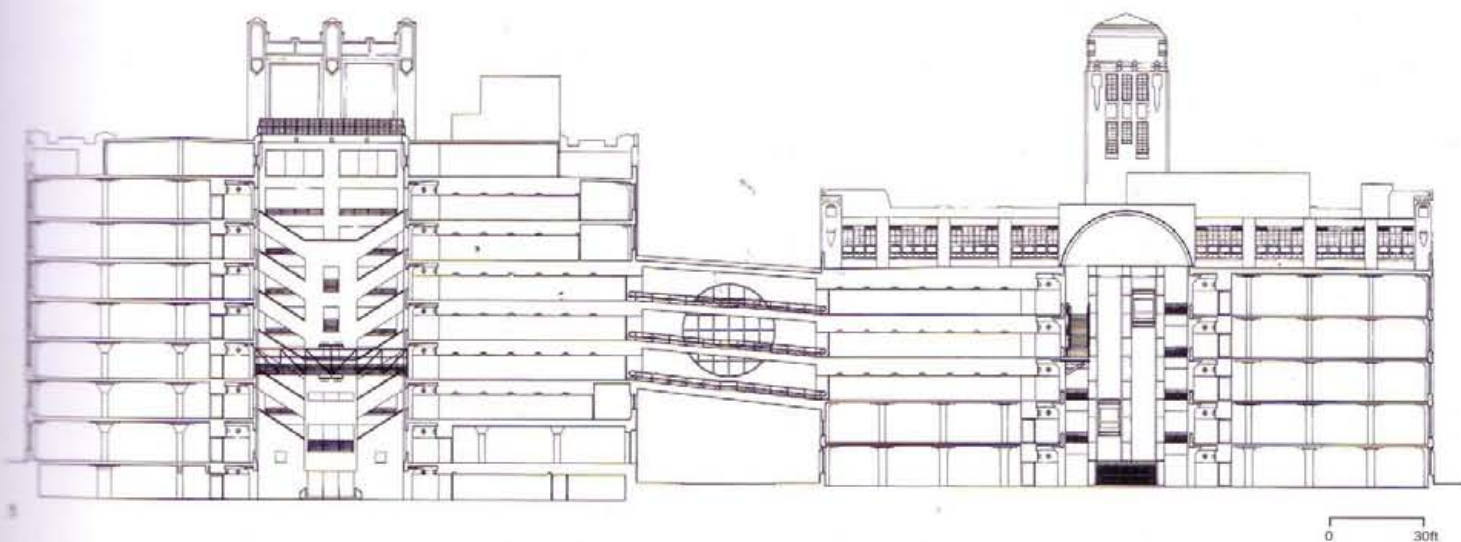

- 6 Center IV plan
  - 7 Center III plan
  - 8 Center II plan
  - 9 Center I plan
  - 10 Centers II and I from plaza
- Opposite:  
Center II atrium

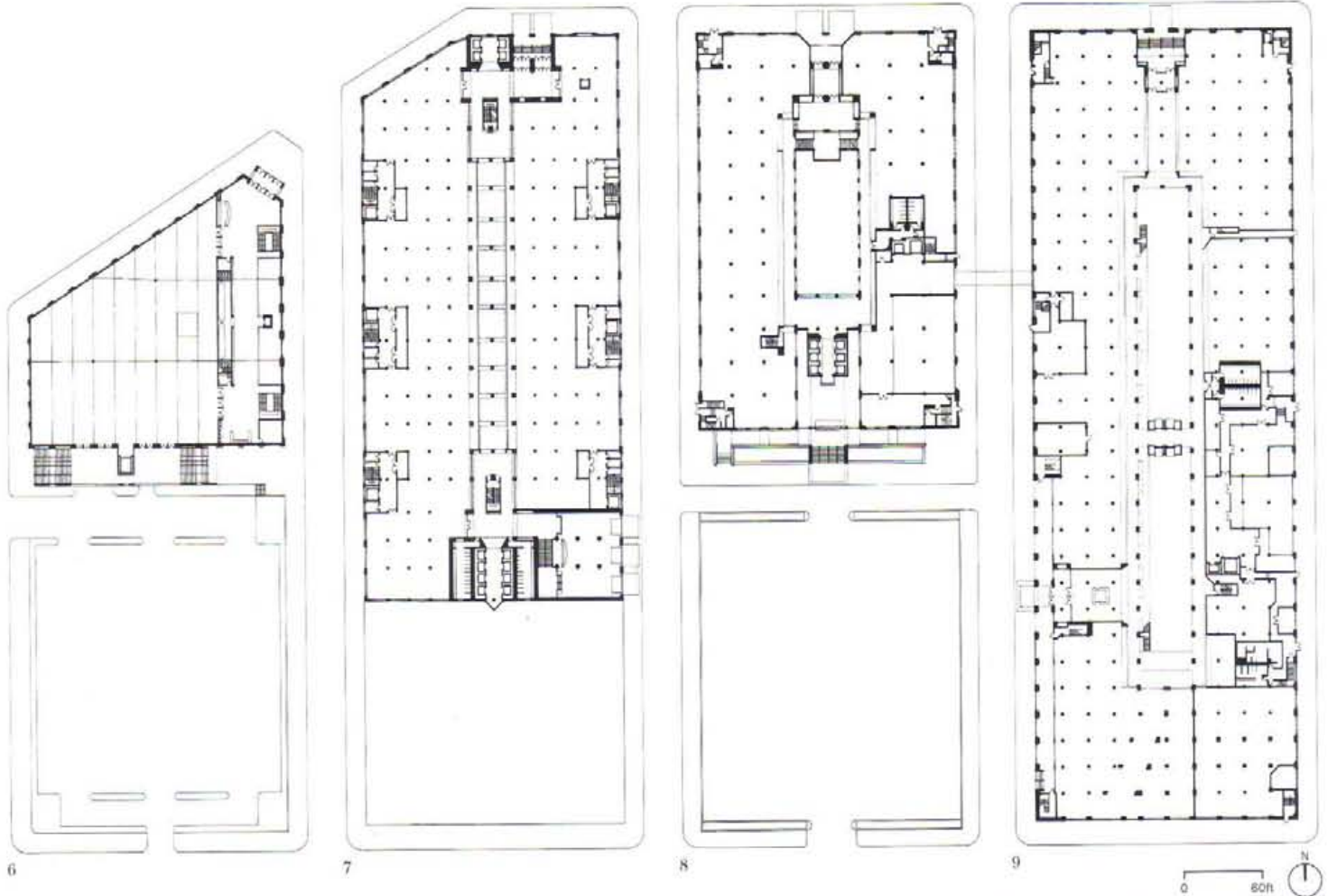





- 12 Center II lobby with new elevator tower
- 13 Center II entry and lobby
- 14 Typical balcony showroom facade
- 15 Center II detail of stair
- 16 Ramp connection in bridge between Centers II and I
- 17 Center I atrium



12



14



13



15



16



## Herman Miller Showroom, International Design Center

Design/Completion 1986/1987

Long Island City, New York

Herman Miller Inc.

21,000 square feet

Rubber flooring; carpet tiles; glass block; drywall; gridded opaque glass; acoustic tiles; custom painted millwork; etched glass; Formica cabinetwork; sandblasted concrete columns; fluorescent, incandescent and accent lighting

This showroom has a flexible design that allows for frequent reorganization of the space and changes of the displays while maintaining a constant sense of presence.

The 21,000-square-foot loft space is on the second floor of Center I in the International Design Center. The showroom is 13 feet 6 inches high with a raised mezzanine floor along its southern edge. Three-foot-diameter concrete columns frame the loft space at 20-foot intervals.

In addition to the display areas, the showroom contains a 60-seat multi-use audiovisual meeting space, a conference room, a pantry, a manager's office, staff workstations, and extensive storage space.

A custom-designed lighting grid defines the principal showroom areas. Suspended from the existing ceiling, the 10-foot-square grid establishes a second horizontal plane for accent lighting, display panels, and hanging fabric.

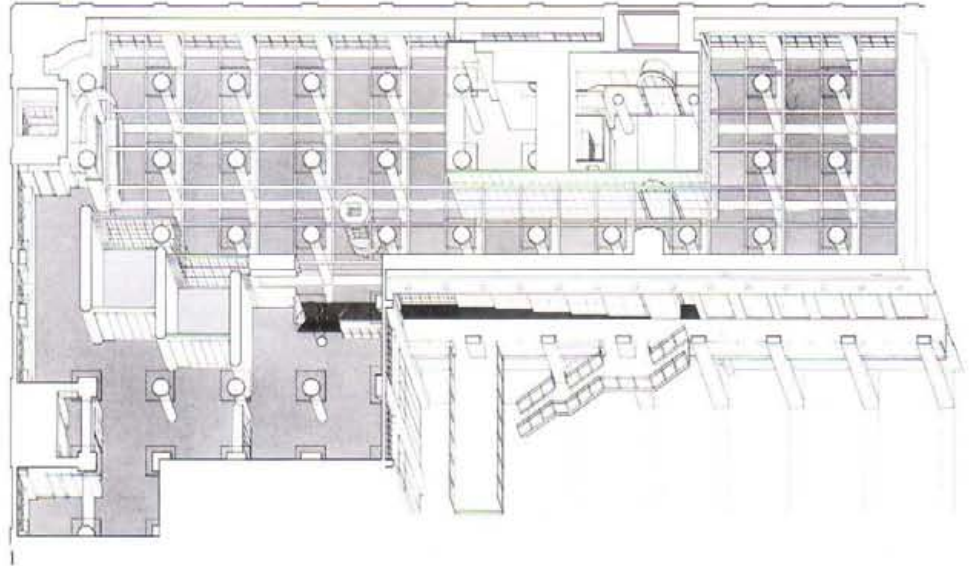



3



4

- 1 Axonometric
- 2 Kiosk and reception
- 3 View of ramp from second level
- 4 Detail of second level from stair
- 5 Entry from public balcony



5

- 6 Office and meeting areas
- 7 Detail of ceiling grid
- 8 Detail of ceiling lighting grid
- 9 Textile display wall
- 10 Conference room



6



7



8



9



## Stevenson Hall, Oberlin College

Design/Completion 1986/1990

Oberlin, Ohio

Oberlin College

48,000 square feet

Amber and beige striped brick, aluminum window frames and doors, porcelain panels

The building is organized to reinforce the intimate scale of the Oberlin campus and to support the residential house model of the college.

The site is adjacent to both institutional buildings and typical three-story Oberlin porch houses. The building massing reconciles these divergent surroundings by reinterpreting the porch house prototype into an institutional model.

Articulated by three identical, pyramidal, skylit dining halls on the second level, the new facility serves 800 students and faculty staff. A continuous linear element unites the three volumes, providing outdoor dining terraces on the upper level and a street-front porch on the lower level. An entry plaza offers access to the house entries, lounges, and administrative offices. This inverted organization provides natural light from above in what is a typically gray climate zone. It also allows three separate dining halls with a common servery and kitchen to be organized within one structure.

On the exterior, two colors of horizontally banded brick and cast stone relate to nearby buildings by Cass Gilbert. By reversing Gilbert's choice of materials, primarily limestone with brick trim, the building responds to the adjacent contextual fabric while establishing a dual-scaled hierarchical rendering for the new facility.

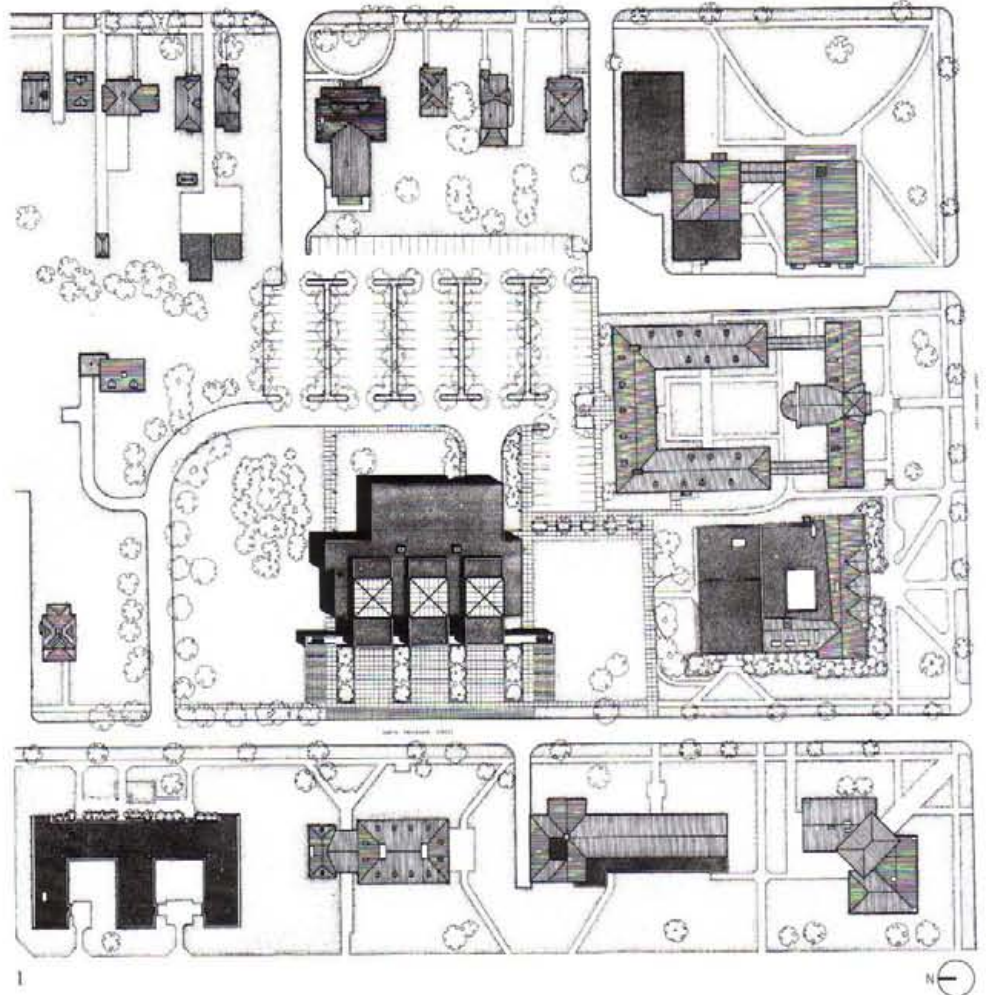



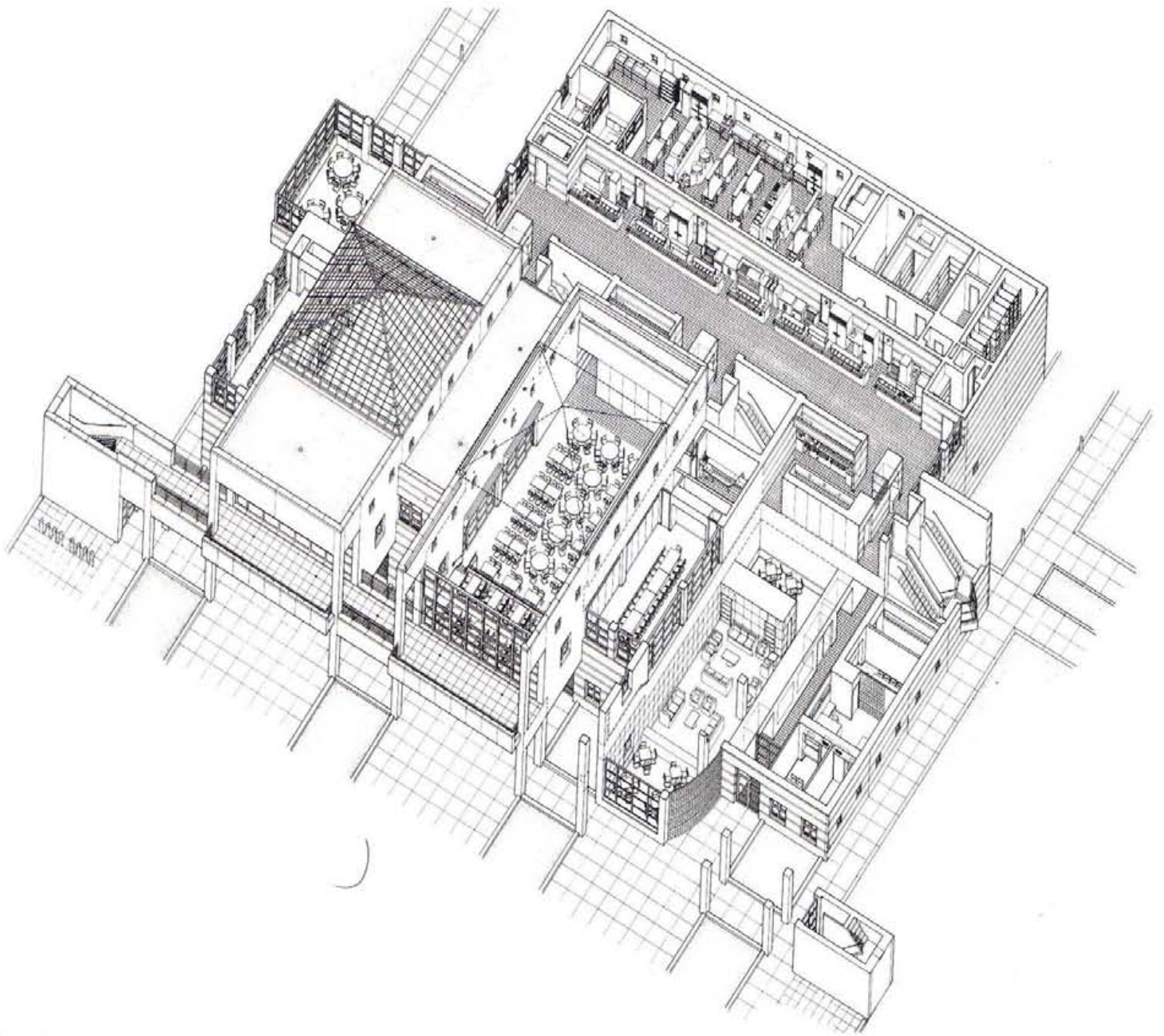

- 1 Site plan
- 2 West facade from campus
- 3 Axonometric
- 4 Pedestrian walk with entry porch and terrace above
- 5 Corner of south facade

4

5

- 6 Second floor plan
  - 7 Ground floor plan
  - 8 South interior stair
  - 9 Servery with dining hall beyond
  - 10 Typical student lounge space
- Opposite:  
Typical dining hall

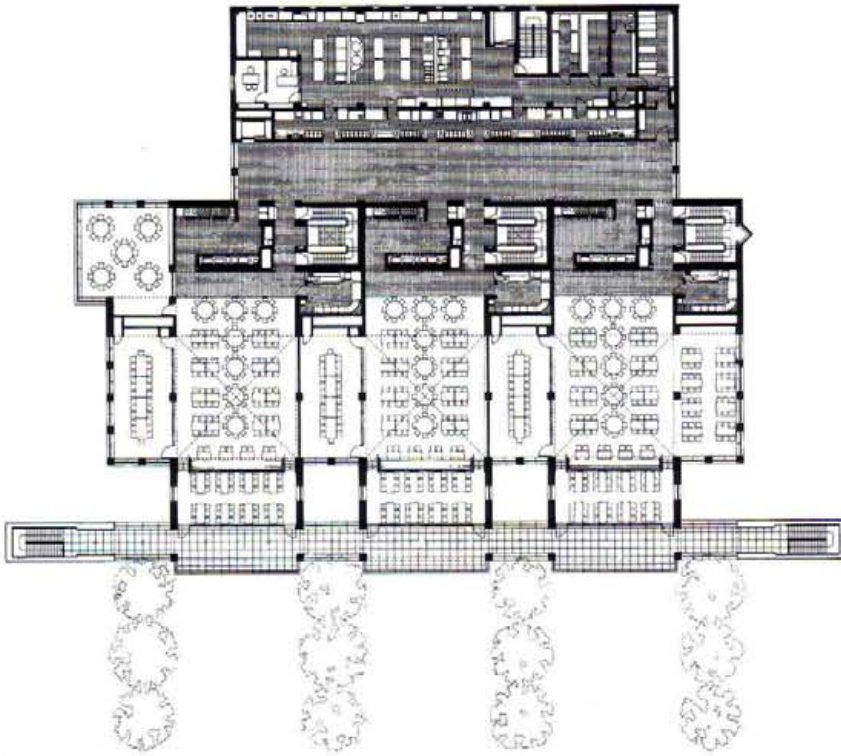

6

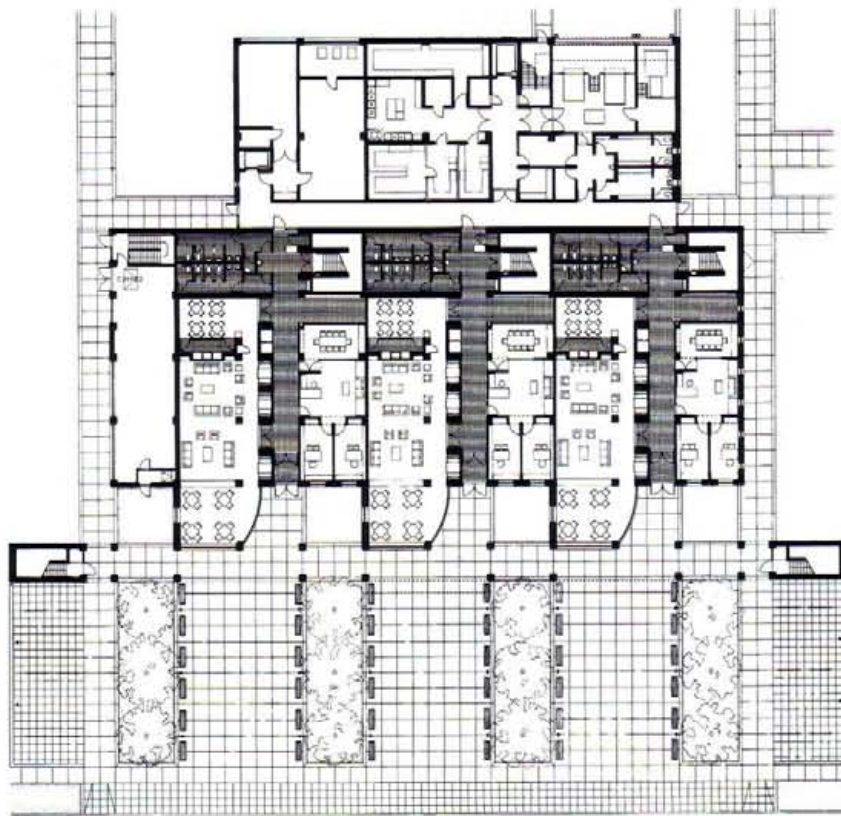

7

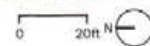

8



9



10



## SBK Entertainment World Inc. Offices

Design/Completion 1987/1988

New York, New York

SBK Entertainment World Inc.

42,000 square feet

Marble, honed black granite, ebonized oak, glass block, brass

This interior for a record and music publishing company occupies two floors of a typical 1960s Manhattan office building.

The plan is organized around a two-story entry and reception area. At the reception the architectural grid, articulated by the stone floor and oak wall panels, is modulated to create a wide cylindrical stair, connecting the elevator lobbies and internal corridor/gallery spaces to the perimeter offices.

Solid, transparent, and translucent planes delineate hierarchical spaces along the circulation galleries. Partners' offices are designed as loft volumes with panoramic views.



2



- 1 Entry/reception space
- 2 Reception space from stair
- 3 Screening room
- 4 Typical secretary workstations and circulation corridor
- 5 Northwest interior corner



4



5

- 6 Chairman's office
- 7 President's office
- 8 Chairman's office
- 9 43rd floor plan
- 10 42nd floor plan
- 11 Main stair



6



7



8

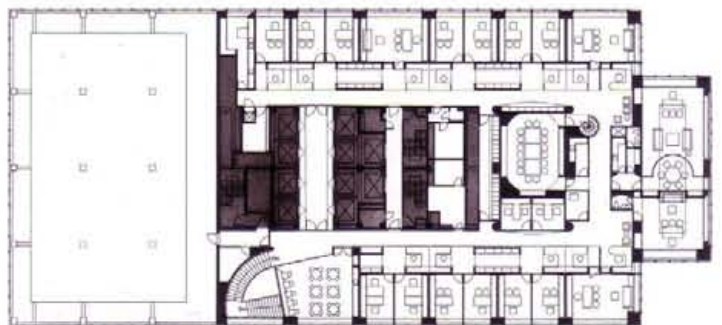

9

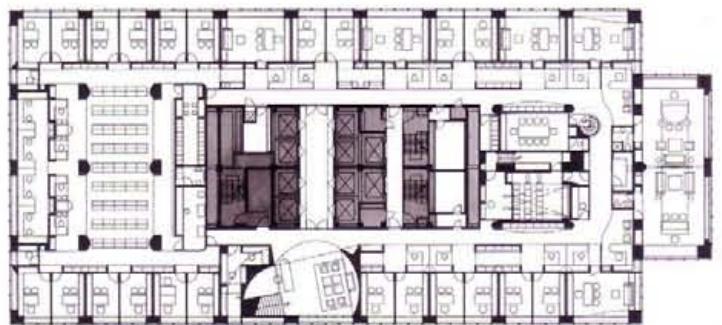

10

0 20ft

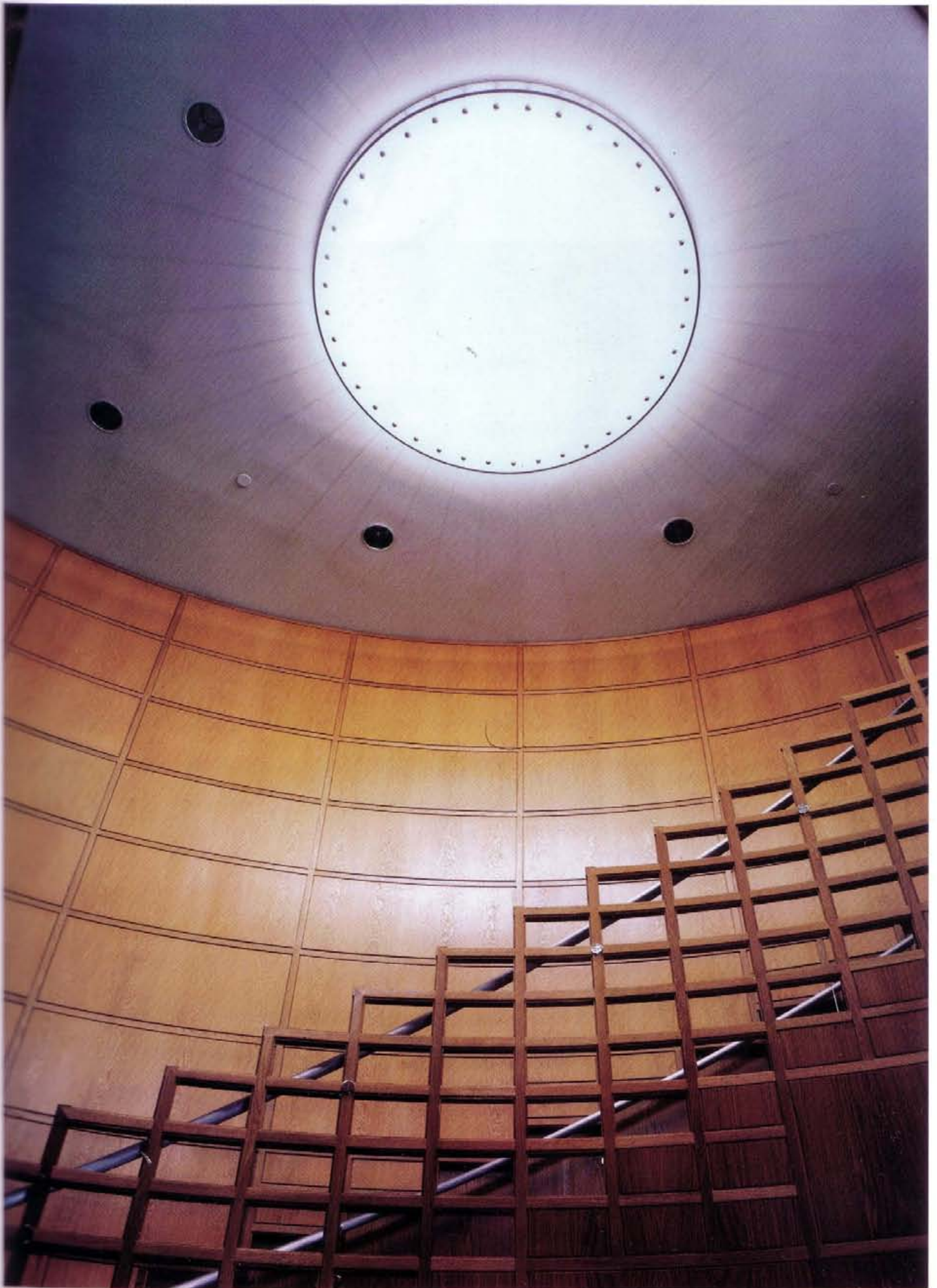

## Oceanfront Residence

Design/Completion 1988/1992

Malibu, California

10,500 square feet

Private owner

Flamed buxy limestone, western cedar siding,  
lead-coated copper standing seam roof

Maple veneered cabinets; aluminum windows and doors;  
white, patterned, and clear glass

This private residence is located on a 16,500-square-foot site which parallels the Pacific Coast Highway to the north and the Pacific Ocean to the south. Two-story residences define the east and west boundaries. A combination of row house and court house typologies generated the parti. Interlocking building volumes and outdoor spaces are layered within the framework of the site, resulting in a hierarchical sequence.

The highway facade is a layered, abstract horizontal wall punctured by an entry gate that leads to the first site layer. This wing accommodates a screening room, a guest house, and a garage on the ground floor, and two children's bedrooms, a playroom, and a caretaker's apartment (over the garage) on the second floor.

The transition from the "gate house" to the "main house" is through the second layer pear tree courtyard. The courtyard is defined to the east by a service wing, accommodating the kitchen, pantry, and breakfast room on the ground level, and the exercise room, dressing room, and master bathroom on the second level. The courtyard is terminated to the west by a bridge that connects the children's suite to the main house.

The third layer establishes the main house and provides a living room, dining room, library, and porch on the ground level, and the master bedroom, study, and decks on the second level, all oriented towards the ocean. The pool terrace extends the pear tree courtyard west of the main house and south of the gate house; it is in turn extended to the south by the ocean terrace to form the fourth site layer and the edge to the beach.

The parti reinforces the visual and psychological transition from the acoustically invasive highway to the beach/ocean horizon.

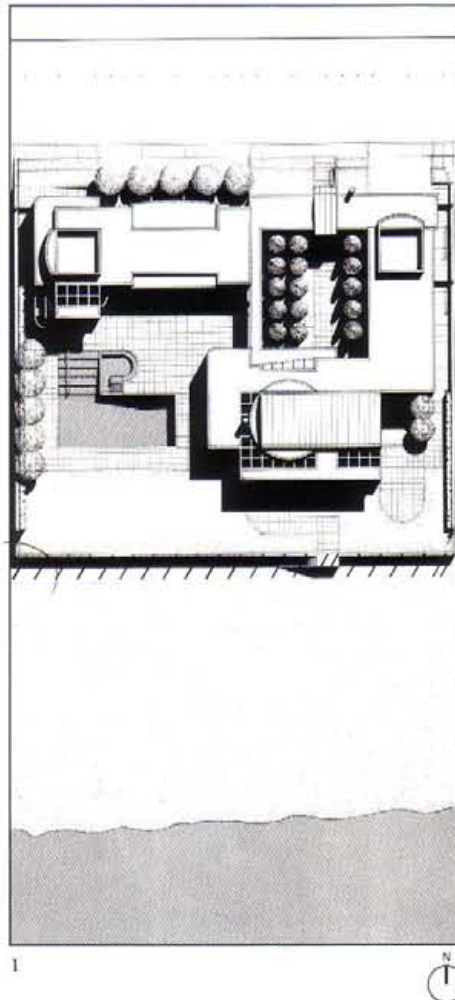

- 1 Site plan
- 2 Southeast corner of main house
- 3 View from southwest
- 4 North facade, closed to the road
- 5 South facade, open to the ocean







- 6 Second level plan
- 7 Ground level plan
- 8 Main stair from balcony
- 9 Living area from balcony
- 10 Master bedroom
- 11 Living room from dining area
- 12 View of living room showing second floor balcony
- 13 Gallery and stairs from entry
- 14 Living room from entry
- 15 Screening room

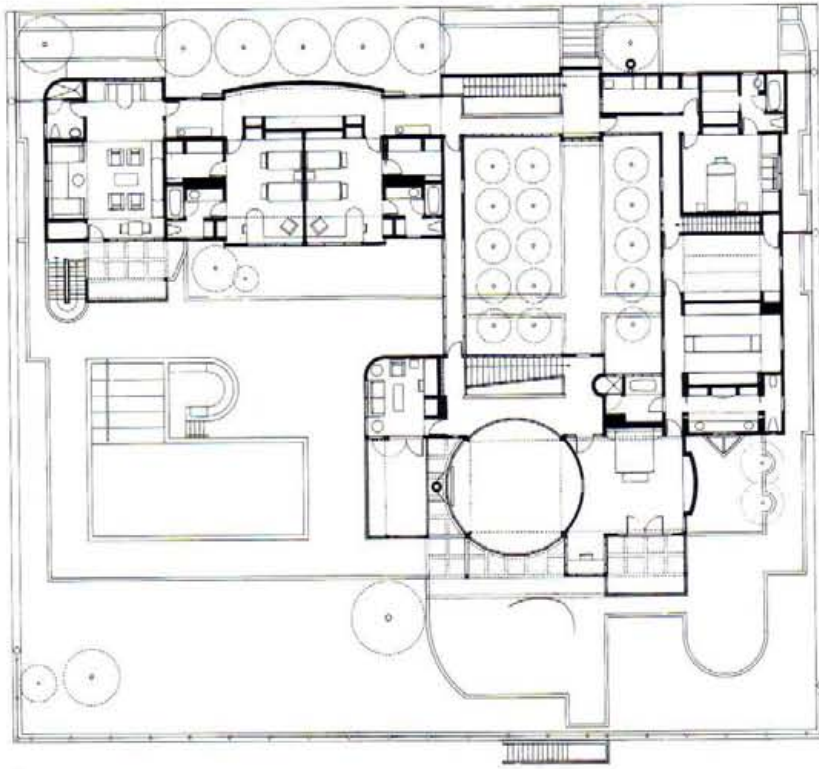

6

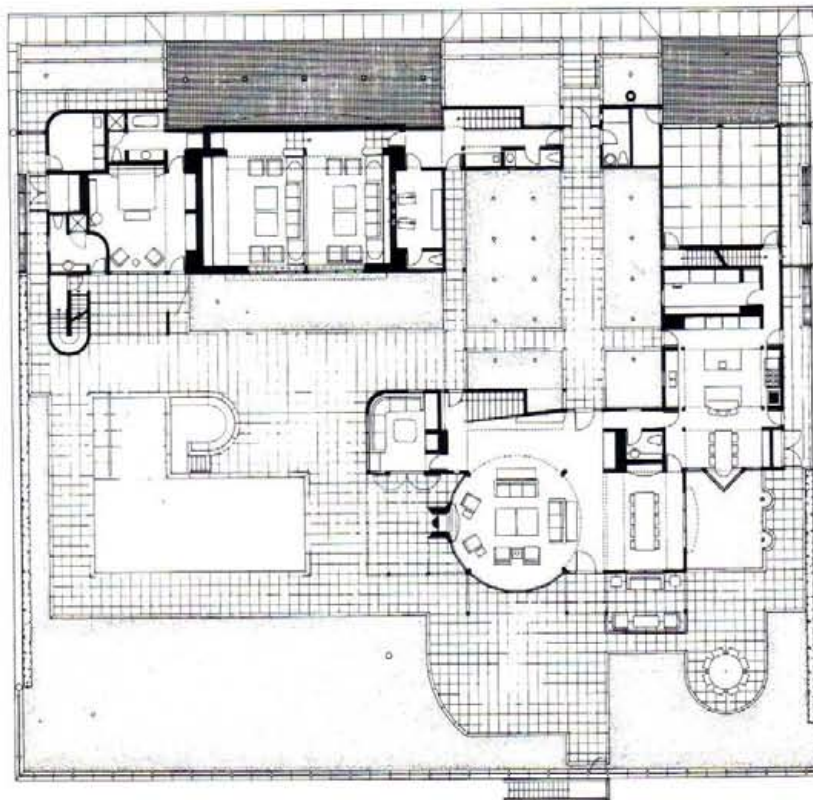

7

0 15ft

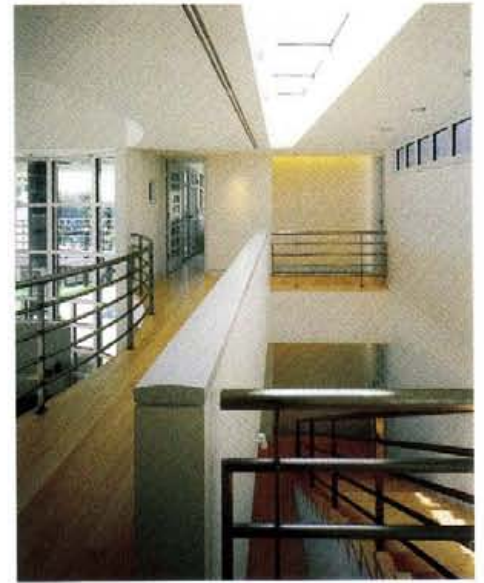

8

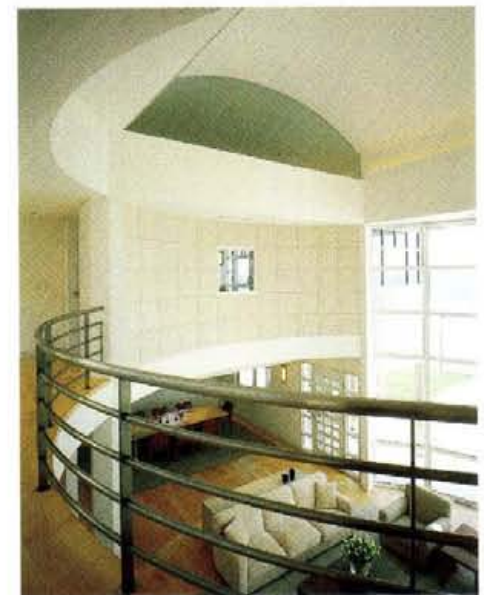

9



10



12



12



13



14



15

## Werner Otto Hall, Busch-Reisinger Museum/ Fine Arts Library Addition to the Fogg Museum

Design/Completion 1988/1991

Cambridge, Massachusetts

Harvard University Art Museums

15,000 square feet

Indiana limestone, gray porcelain panels, glass block,  
aluminum window and door frames, flamed granite

The task of designing a new building for the Busch-Reisinger Museum presented a challenging physical and theoretical problem. While the new building would be connected to a traditional structure, the Fogg Museum, it would also be adjacent to Le Corbusier's Modern masterpiece, the Carpenter Center, and would have to mediate this dual context. As with any urban infill development, it was necessary to address existing streetscape and scale relationships. The design also had to accommodate the constraints imposed by building above an existing underground library structure with limited load-bearing capacity. Finally, the client wanted the new building to have a presence and identity of its own, distinct from that of the Fogg Museum.

The program called for the building to house the new addition galleries and study archives for the Busch-Reisinger collection as well as parts of the Fine Arts Library relocated from the Fogg.

The solution refers to the formal architectural organization of the Fogg Museum design. One side of the existing atrium's perimeter circulation is extended into the new building and becomes the connection between the two major massing elements of the design. To the north are the primary spaces: the library reading room on the ground floor and the permanent collection galleries on the second floor. These are organized in a two-story element which extends the central axis of the Fogg to Prescott Street, presenting the new building's primary facade.

*Continued*

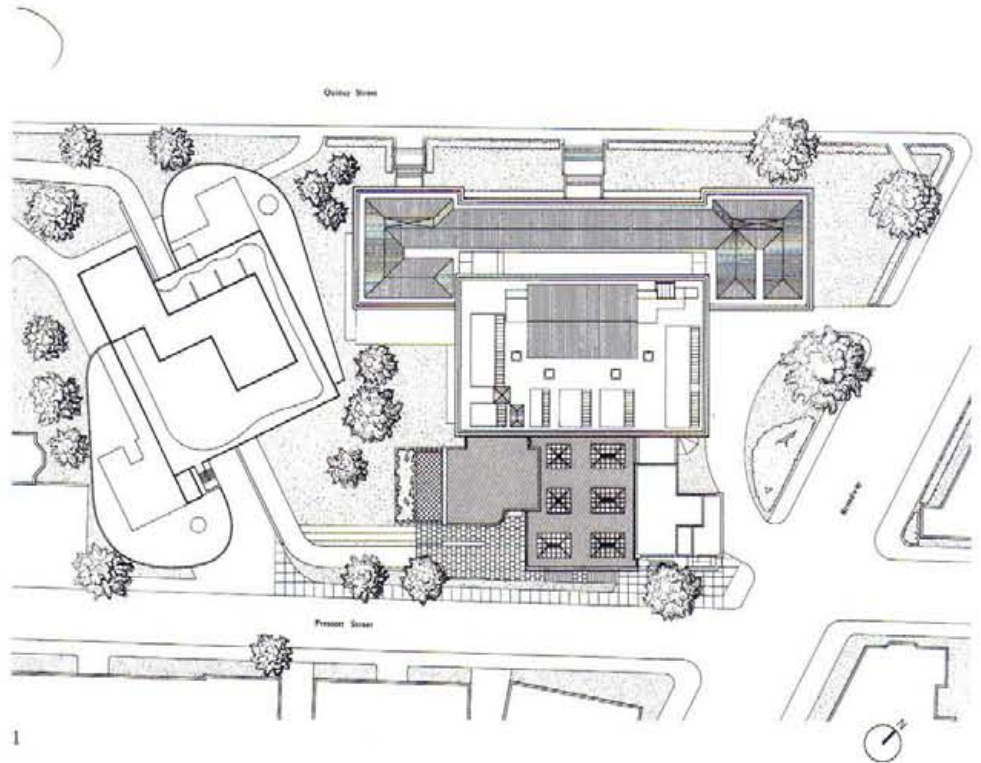

- 1 Site plan
- 2 East entry facade from street
- 3 East facade from the corner of Prescott Street and Broadway
- 4 Overall view showing completion/extension of Carpenter Center ramp through site
- 5 Detail of south facade
- 6 South facade from Carpenter Center



3



4



5

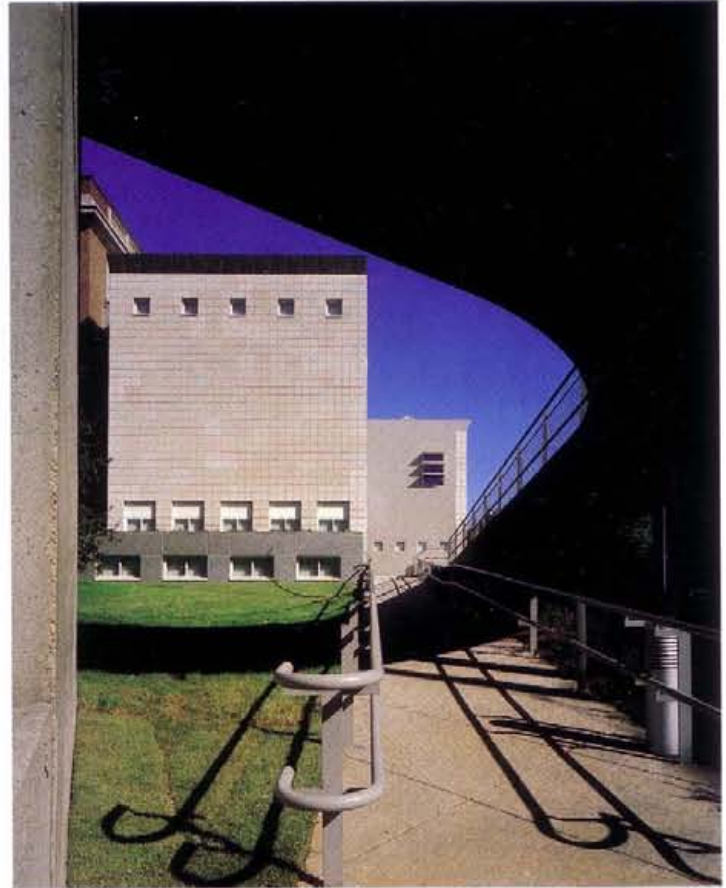

6

To the south are the support and smaller spaces: the library staff offices on the ground floor, the temporary exhibition gallery on the second floor, and the study archives on the third floor. These spaces are organized in a three-story element which is set back from the street and rotated 90 degrees to address the Carpenter Center. The interlocked massing of these two elements completes the orthogonal building framework which surrounds the Carpenter Center.

The solution also resolves Le Corbusier's compelling site circulation idea. The Carpenter Center ramp, which was intended to provide a mid-block public walkway from Quincy Street to Prescott Street through the building, ended in the Fogg's rear yard without a connection to the sidewalk. The design extends the ramp onto a new plaza from which one can either enter the library or descend a new exterior stair to the street.

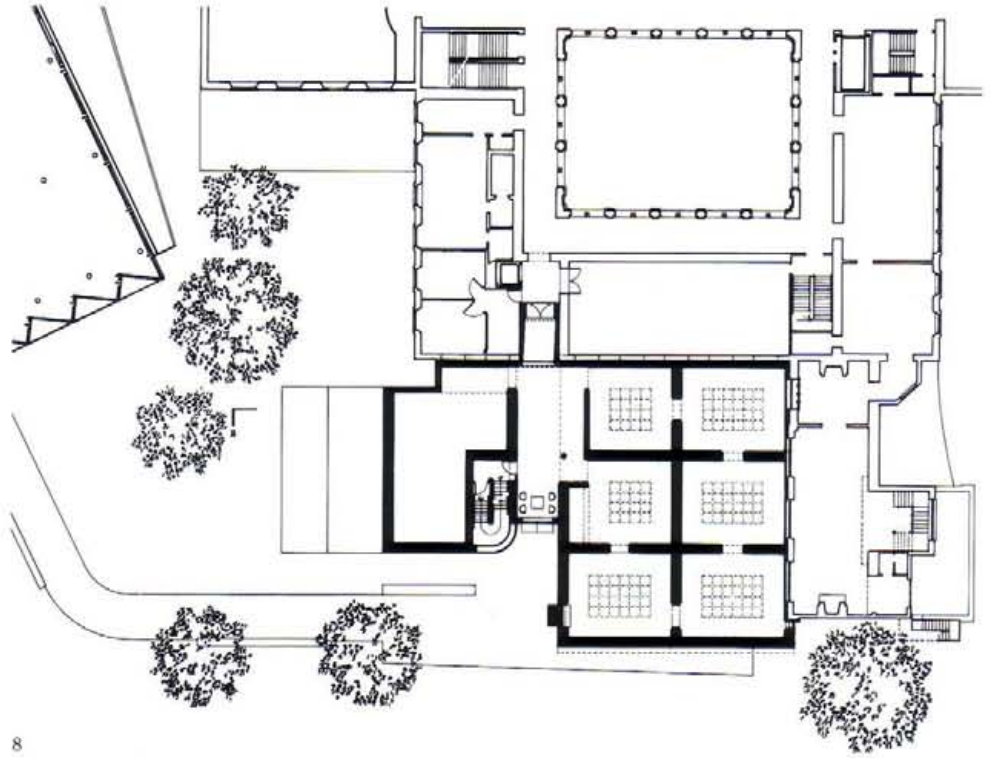

8

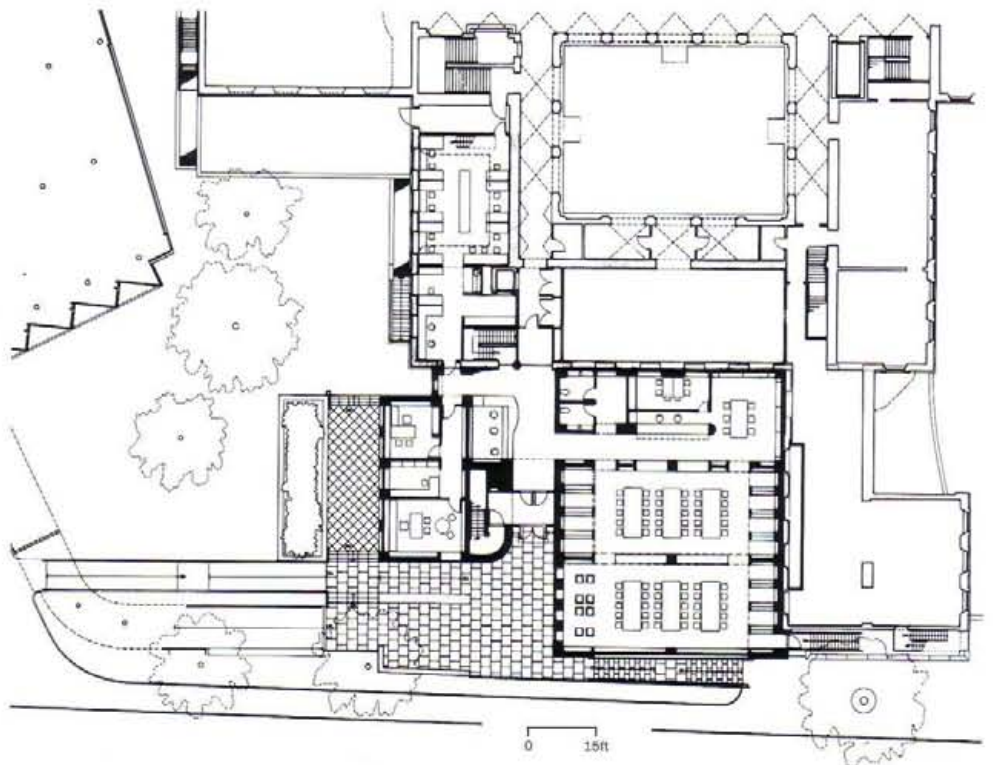

9



7



10

- 7 South window from gallery
- 8 Second floor plan
- 9 Ground floor plan
- 10 Entry gallery
- 11 Study archives
- 12 Permanent collection galleries
- 13 Study archives detail



11



12



13

14 North section

15 South section

16 Section

Opposite:

Permanent collection galleries

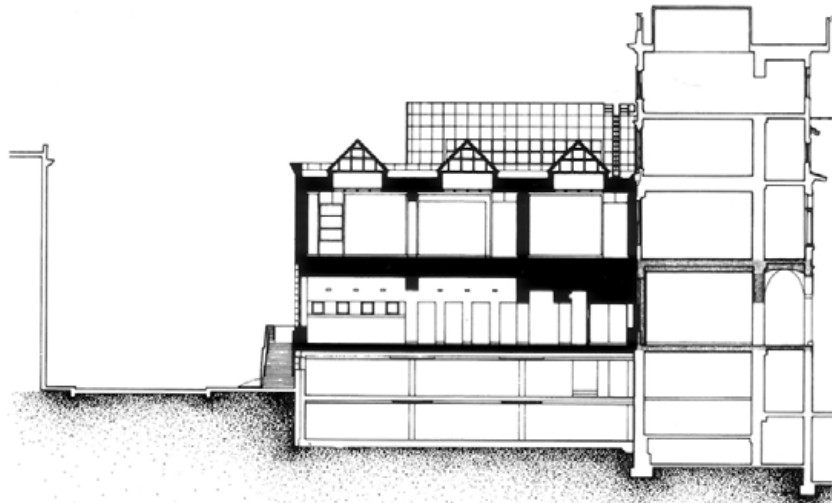

14



15

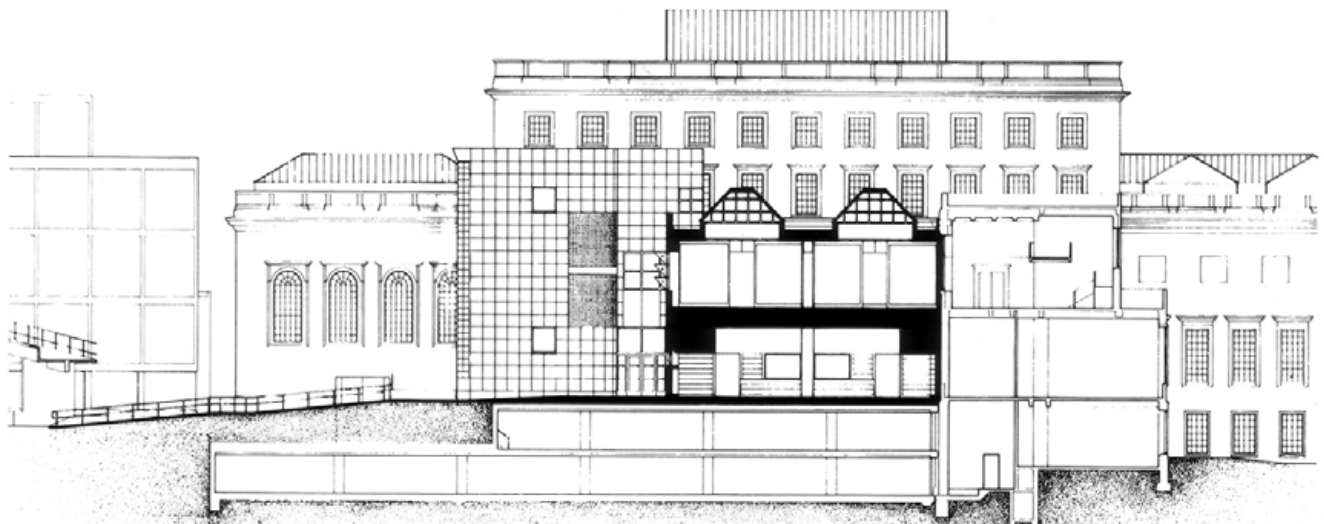

16







- 4 Master bedroom
- 5 Master bathroom
- 6 Gallery from entry
- 7 Fireplace wall detail
- Opposite:  
Dining area



4

5



6

7



## Universal Studios Inc. Divisional Headquarters

Design/Completion 1989/1998

Beverly Hills, California

Universal Studios Inc.

90,000 square feet (office building);

130,000 square feet (below-grade garage)

Granite base with limestone walls, beech wood, stainless steel, reinzink (zinc) panels, Kalcurve

This project is located in the Beverly Hills Industrial District where zoning restrictions limit the height of buildings to three stories. The typical cornice line along Third Street is reinterpreted by a barrel-vaulted, translucent Kalcurve skylight running the length of the building and incorporating the third-floor executive offices.

Site and program variants are exploited to create a complex, hierarchically asymmetrical building. The screening room marks the garage entry and ramp; conference rooms occupy a tower at the corner, adjoining a plaza and a reflecting pool and fountain. The four-story conical atrium is the central volume in the building, accommodating entry, reception, and vertical circulation.

The primary rectilinear mass is clad with a combination of smooth gray limestone and textured green granite in contrast to the zinc panels of the screening room, conference tower, and elevator core. The industrial steel window system has a powder-coated finish and is glazed with gray tinted and ceramic frit glass. Entrance railings and miscellaneous trim are in stainless steel.

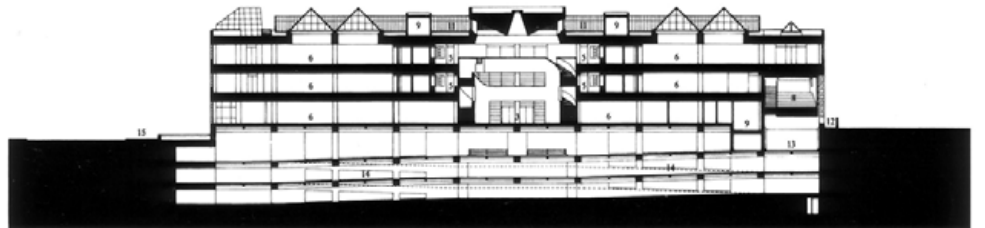
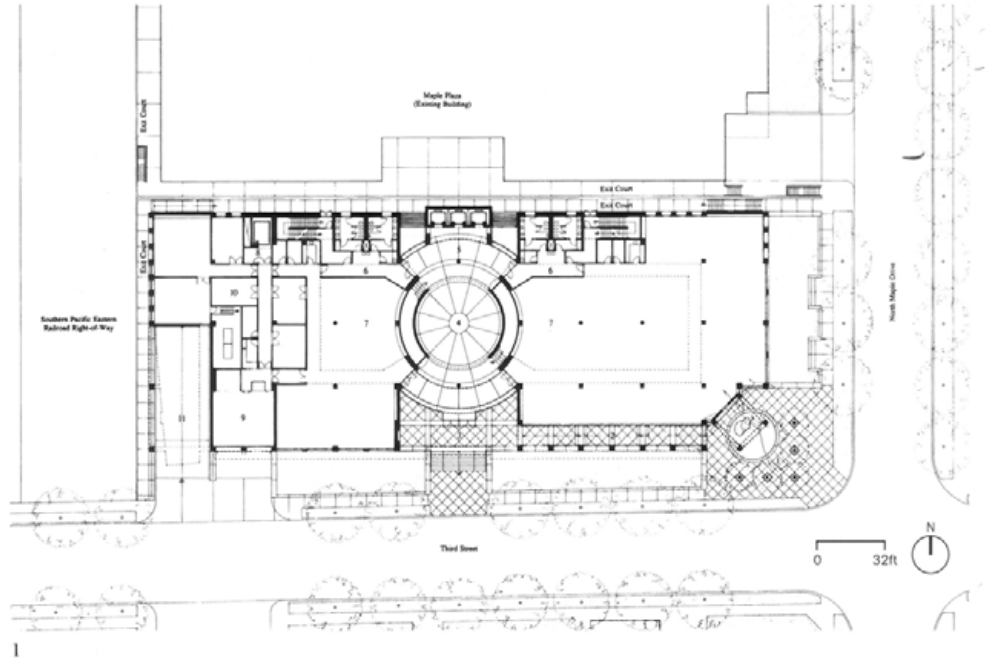

2



3

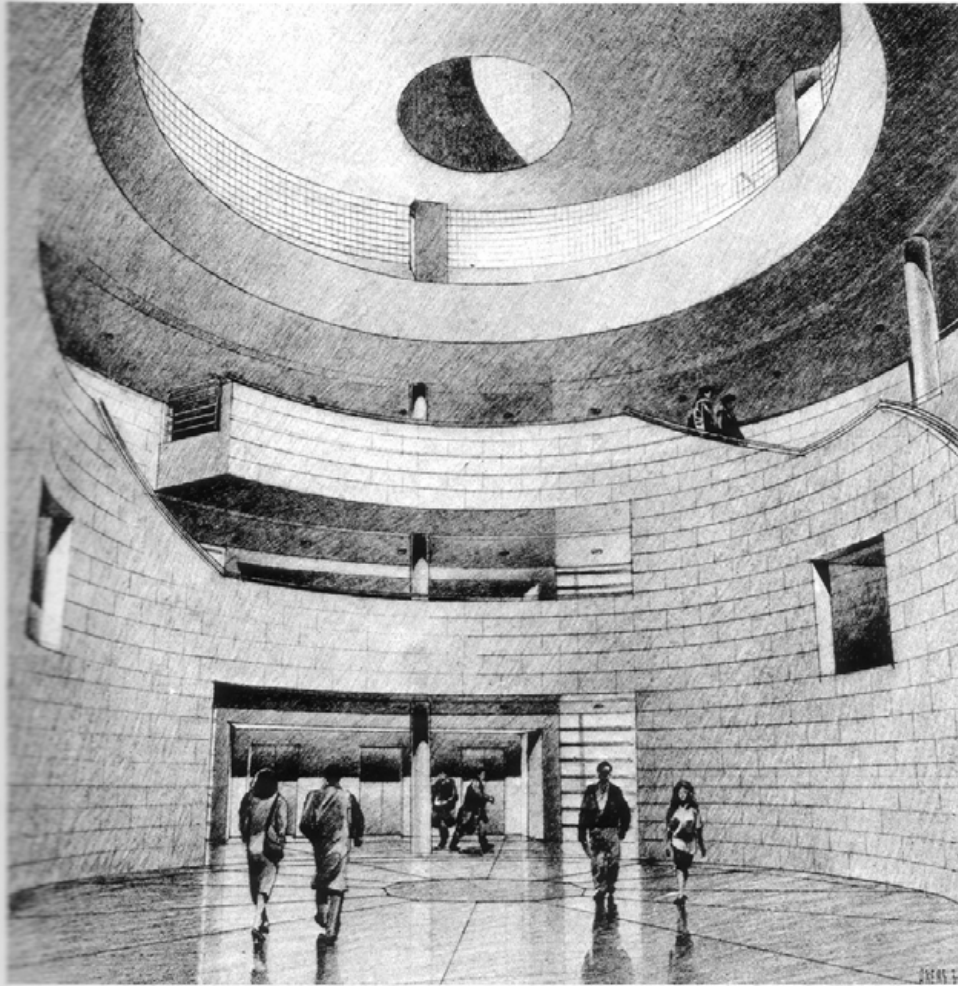

- 1 Ground floor plan
- 2 Longitudinal section
- 3 View of building at the intersection of Third Street and West Maple Drive
- 4 Entry circulation rotunda
- 5 Southwest corner from Third Street



## Contemporary Resort Convention Center, Walt Disney World

Design/Completion 1989/1991

Lake Buena Vista, Florida

Walt Disney Corporation

120,000 square feet

Painted stucco, enameled steel panels, glass block, aluminum window system

Painted gypsum board, stained oak, fabric panels, custom metal ceiling, custom painted carpet

The Contemporary Resort Convention Center is an addition to Walt Disney's visionary Contemporary Hotel, completed in 1971. A new 2.5-acre entry plaza joins the two buildings and leads to a porte-cochere entry for the hotel. The addition accommodates a 45,000-square-foot conference room that can be divided into three multipurpose spaces; a 7,000-square-foot ballroom; three prefunction spaces; five meeting rooms; and a full-service kitchen with loading facilities.

Situated at the center of the parti, the main ballroom is flanked by meeting rooms at either end. The entry and prefunction spaces are layered across the front of the building, with the kitchen and support areas located at the rear. Natural light, color, and texture mark the primary and secondary circulation systems and articulate the major volumes. The building's horizontal silhouette is reinforced by the strong use of color, which contrasts with the vertical, gridded facade of the hotel.

Four major elements create a collage/ assemblage: the curved, striped primary volume of the main ballroom and prefunction gallery; the entry canopy and prefunction gallery; the entry canopy and skylit porte-cochere; and the two rotundas, one connected to the hotel by stairs, escalators, and a glass-block bridge, and the other accented by a square punched window which presents an iconic form on the more visible west corner.

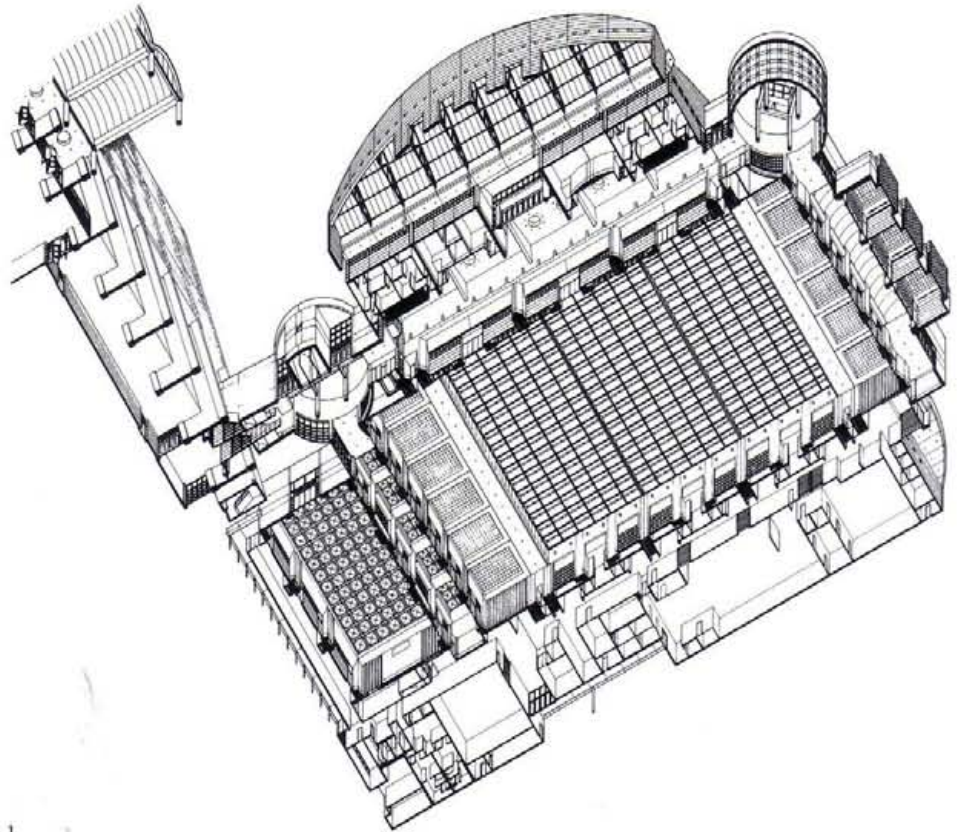

- 1 Axonometric view from below
- 2 Overall view from Lake Buena Vista
- 3 Overall view from Lake Buena Vista by night
- 4 North facade
- 5 Entry plaza and vehicular entry arcade





## Ronald S. Lauder Foundation Offices

Design/Completion 1990/1992

New York, New York

Ronald S. Lauder Foundation

10,000 square feet

Ebonized cherry, millwork, cherry wood and marble floors, painted canvas and plaster walls

The Ronald S. Lauder Foundation is located on the 42nd floor of a building overlooking Central Park. The offices occupy a narrow, rectangular 10,000-square-foot space organized by a single circulation spine/gallery.

The reception/meeting space integrates the circulation gallery with an adjacent conference room. The spine ends in a rotunda that marks the entrance to Lauder's own office, library, dining room, and private work space. A series of secretarial workstations, backed by small private offices, line the perimeter of the spine; a small conference room and service areas are located in the interior.

The proportions of the offices enhance the sense of intimacy created by Lauder's extensive furniture and art collection. The architectural detailing suggests, without imitating, the sense of texture and surface articulation that were central to the craft ethic of the Secessionist period.



- 1 Entry/waiting space
- 2 Typical workstations
- 3 Floor plan
- 4 Main conference room

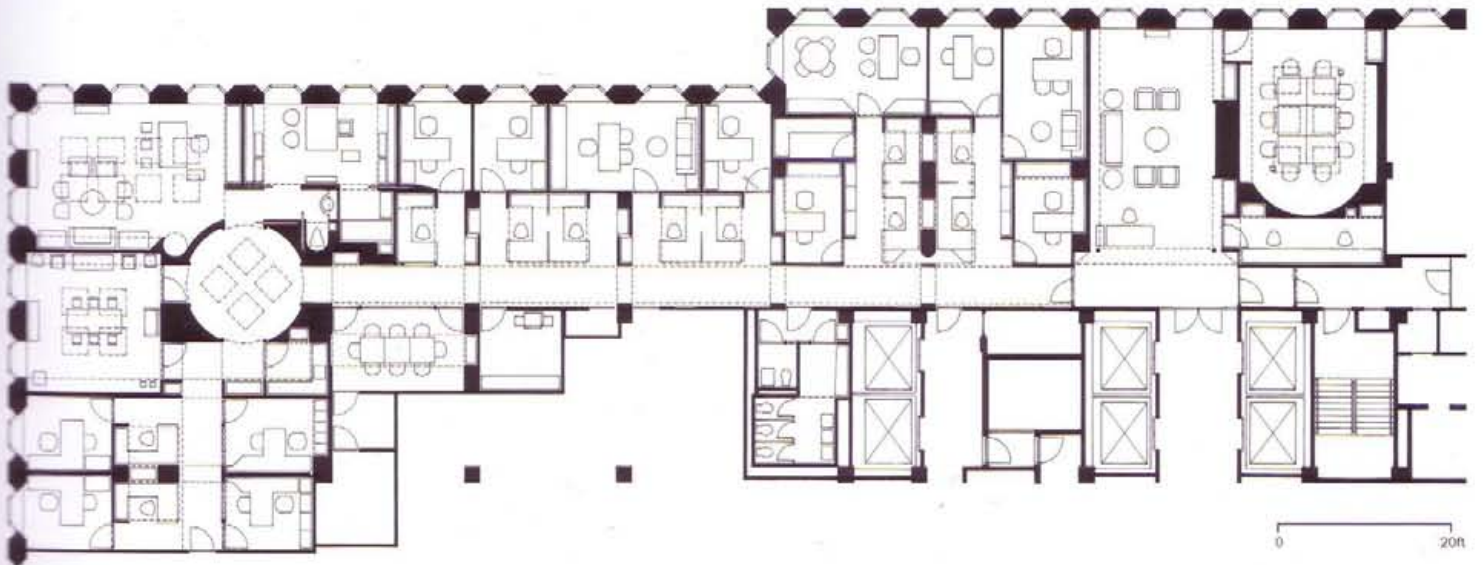

3



4

- 5 Rotunda
- 6 Private dining room
- Opposite:  
Exhibition gallery



5



6



## Capital Group Inc. Offices

Design/Completion 1991/1993

West Los Angeles, California

Capital Group Inc.

32,000 square feet

Maple cabinets, doors and frames; wall covering: plastic laminate; gypsum drywall; vinyl flooring; linear metal ceilings; ceiling tiles; glass block

The team-oriented approach of this investment group is reflected in the egalitarian, non-hierarchical environment of their West Los Angeles offices. There are no corner offices; instead, conference rooms, a boardroom, library, and staff lounge occupy the corners of the two 16,000-square-foot floor plates, with the individual offices and group workstations between them at the perimeter.

A two-story entry and reception space is articulated by an open stair leading to a glass-block bridge that connects with circulation galleries filled with contemporary art. Natural light penetrates the galleries from interior clerestory windows in the office walls.

Each office module has a conference table to facilitate discussions and a U-shaped counter that provides a generous horizontal work surface for an ever-changing assortment of office machines. The perimeter offices were designed to maximize efficiency and flexibility, both technologically and spatially. An integrated cabinet and millwork system of wood paneling and translucent and transparent glass establishes the aesthetic of the entire space.

The company's "open door" philosophy created special acoustic requirements. Recessed doorways to individual offices are lined with perforated vinyl to reduce sound transmission. Ceiling and floor finishes provide additional noise control, and, like the corridor elevations, reflect the functions of different spaces.



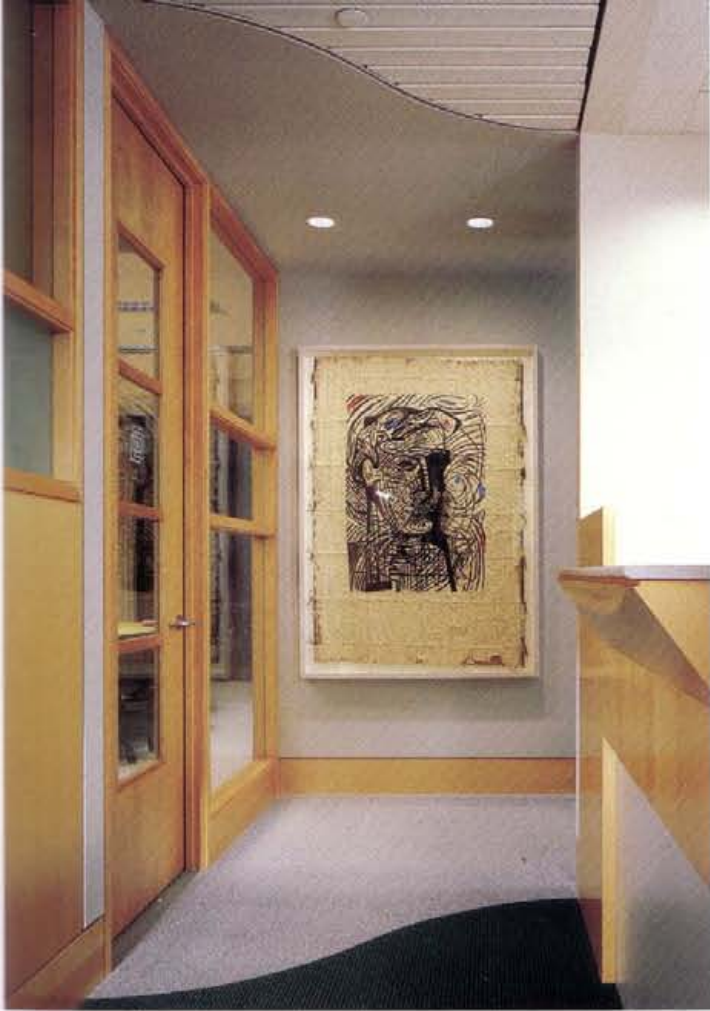

- 1 Entry/reception space
- 2 Typical corner of public corridor
- 3 Second level entry bridge



5

- 4 15th floor plan
- 5 16th floor plan
- 6 Conference room/waiting reception
- 7 Secretary workstations
- 8 Associate's office
- 9 Main conference room

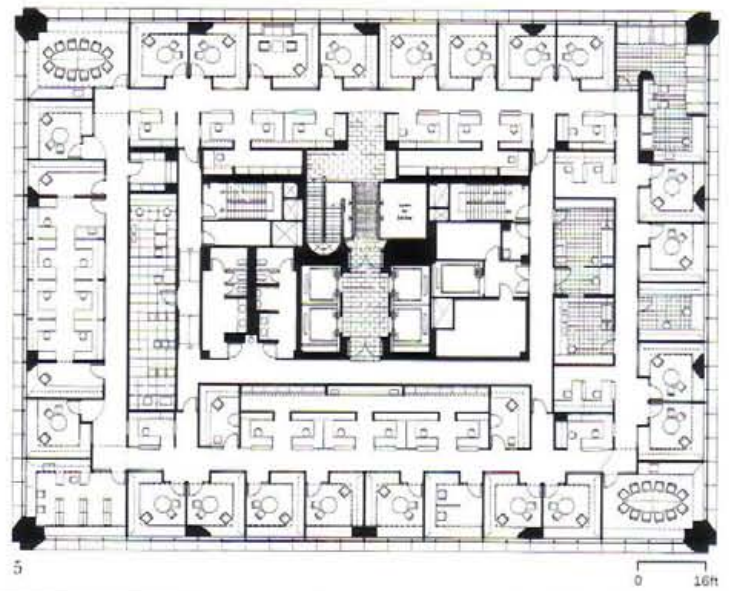
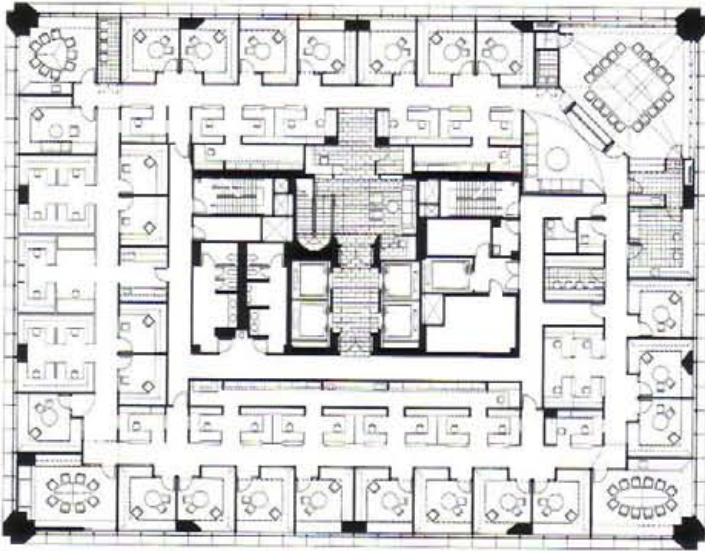

6



7



8



9



## PepsiCo Headquarters Dining Facilities

Design/Completion 1995/1996

Purchase, New York

PepsiCo Inc.

18,000 square feet

Steamed Danish beech, marble, brushed stainless steel, acrylic panels, plaster barrel vaults, Almute

This project is the first phase of an ongoing Gwathmey Siegel master plan for the extensive PepsiCo headquarters. Situated in a suburb of New York City, the complex was originally designed by Edward Durrell Stone in the late 1960s. The program includes food preparation areas, storage and mechanical rooms, a self-service cafeteria, and dining room and garden areas.

The entry lobby joins two circulation nodes and displays a "logo wall" of back-lit acrylic panels inflected towards the cafeteria entrance. Inside the cafeteria, food serveries and counter walls are distributed at the perimeter of the space to allow maximum flexibility for equipment arrangements, as well as uninterrupted circulation into the dining area. The main dining room seats up to 300 people and provides access to the patio and garden beyond.

The overall 5-foot planning grid of the PepsiCo complex was used to develop a proportioning system that locates and unifies all architectural, electrical, and mechanical elements.



2



1



3

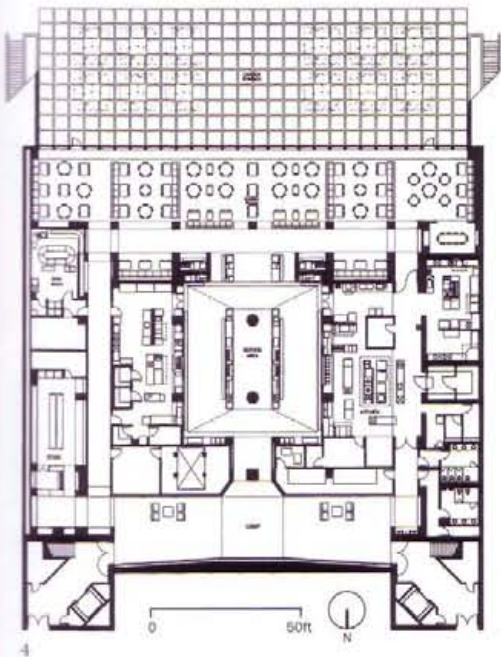

- 1 Dining room detail
- 2 Entrance lobby
- 3 Servery
- 4 Floor plan
- 5 Dining space



## Social Sciences Building and Computer Center, University of California at San Diego

Design/Completion 1991/1995

La Jolla, California

University of California at San Diego

75,000 square feet

Exposed concrete, black and white ceramic tiles, stucco, powder-coated aluminum panels, brushed stainless steel, frosted glass, reflective glass

This facility is situated at the top of a ridge affording panoramic views of the Pacific Ocean to the west and the mountains to the east; it runs parallel to Ridgeway, the major north-south pedestrian spine of the campus.

The ground floor accommodates conference seminar rooms, laboratories, a media room, and demonstration classrooms situated adjacent to a series of open courtyards which provide space for informal public gatherings. The second through fourth floors contain the administration and faculty offices for six departments within the Social Sciences division: Latin American Studies, Sociology, Urban Studies, Political Science, Anthropology, and Ethnic Studies.

The exterior is clad in a combination of white and black ceramic tiles and light gray stucco, with accent walls and columns in powder-coated aluminum panels. Railings and miscellaneous metal trim are in brushed stainless steel. The operable window system combines jalousies with integral louvers, frosted glass clerestories, and reflective glass view windows, forming a composite environmental wall system. Ceiling fans and operable transoms over the doors provide cross-ventilation.

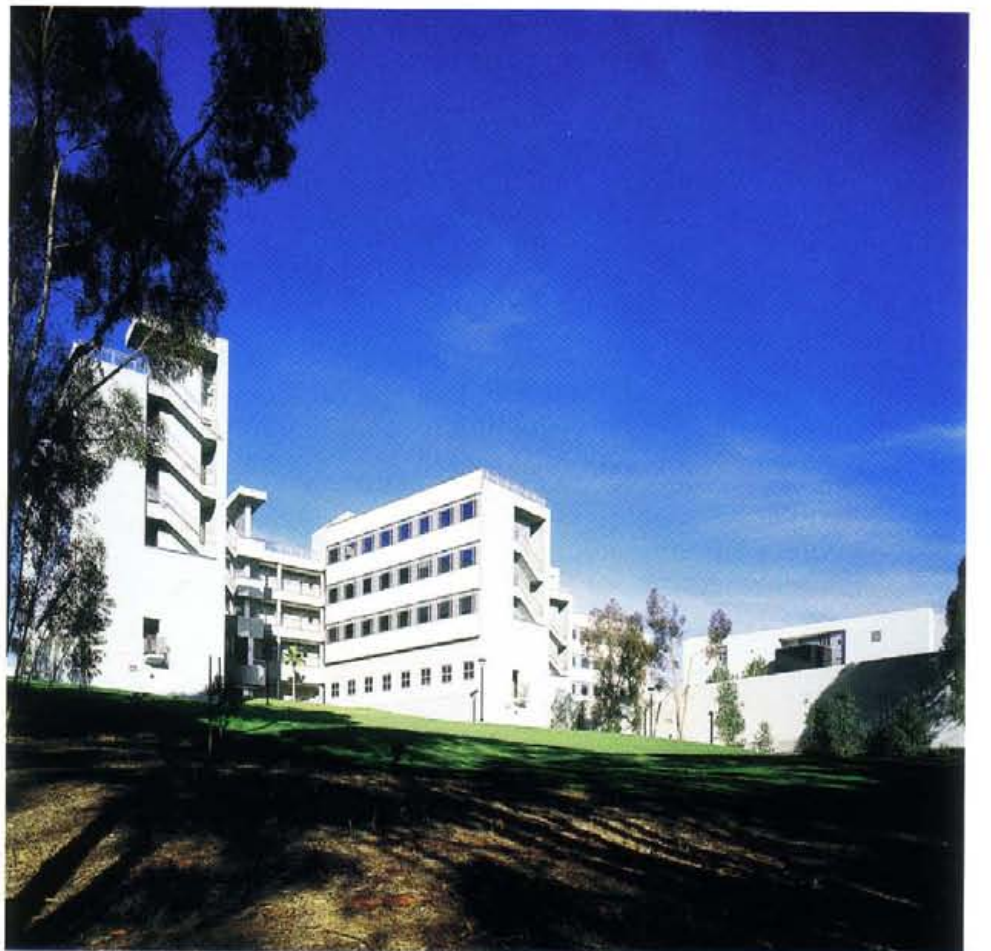
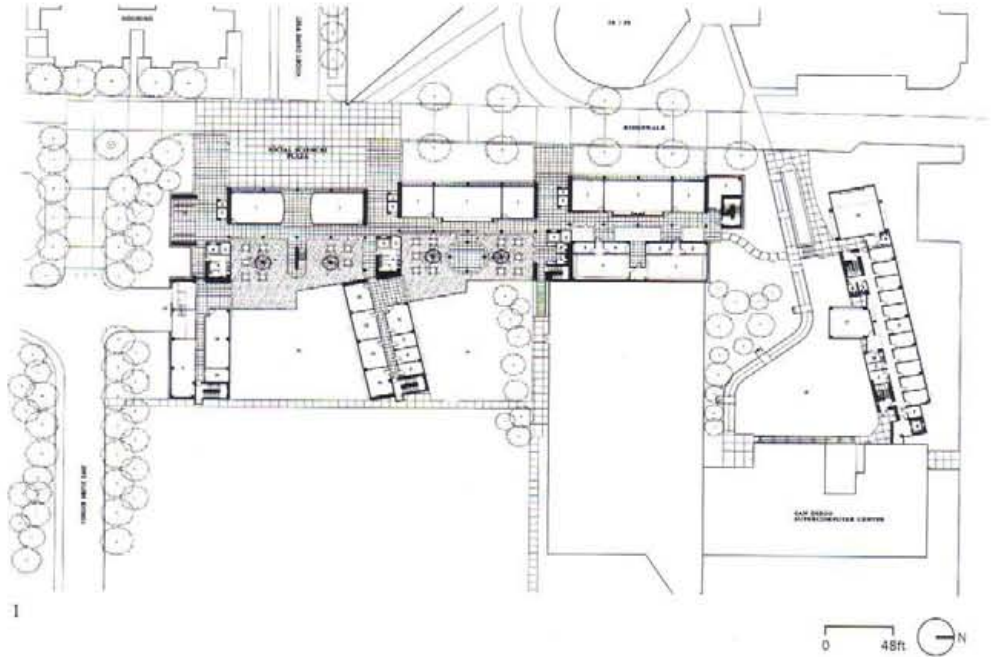

- 1 Site/ground floor plan
- 2 View from the southwest
- 3 View from the east
- 4 View from the southeast
- 5 View to demonstration room from supercomputer addition
- 6 Detail of east facade of supercomputer office addition
- 7 Detail of supercomputer office and entrance
- 8 View of supercomputer office addition



8

- 9 Third floor plan
- 10 Second floor plan
- 11 Typical office workstation
- 12 Corridor detail
- 13 Detail of entrance to supercomputer addition

Opposite:

View from west of supercomputer office addition with demonstration room on the left

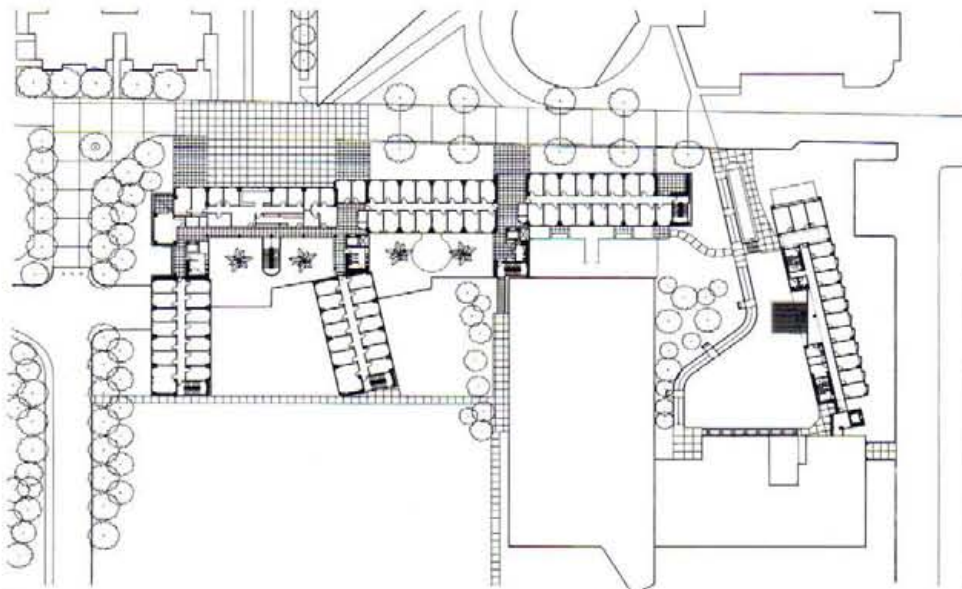

9

0 48ft

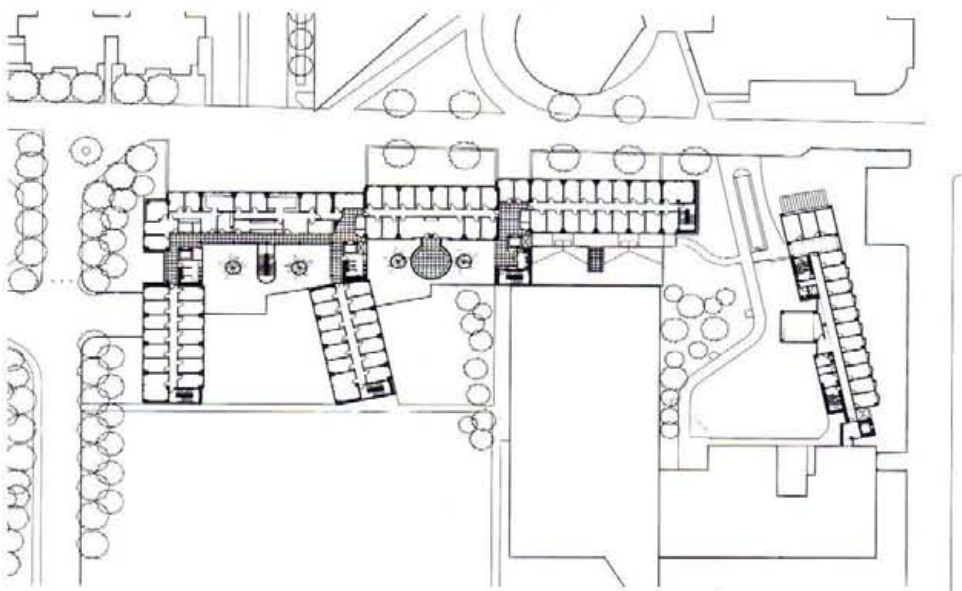

10



11



12



13





- 4 Healy Hall
- 5 Healy Hall main level
- 6 Typical level stack plan
- 7 Entry level plan
- 8 Lower level plan
- 9 Entry hall from information desk
- 10 Lewis B. and Dorothy Cullman Circulating Library and Reading Room with periodical display



4



5

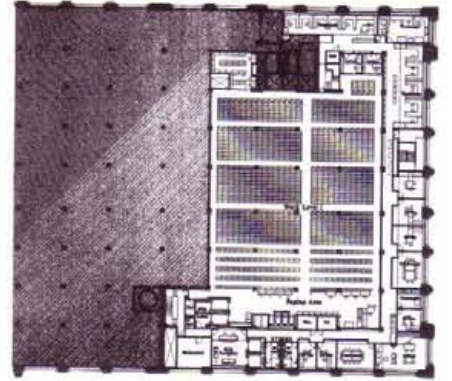

6

0 32ft

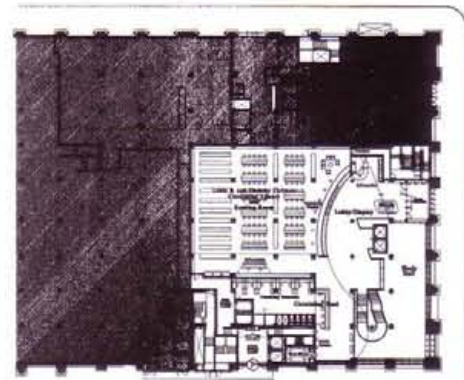

7

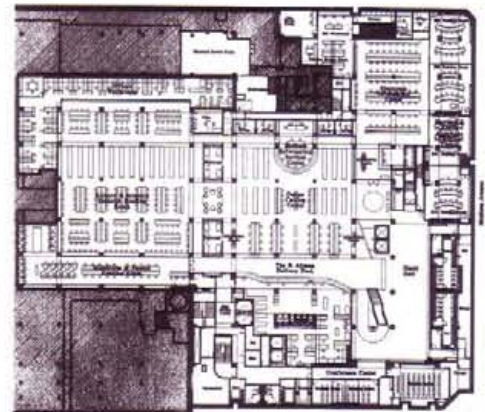

8





The public areas are distributed on the ground and lower levels, providing maximum horizontal adjacency for the research library on the lower level, and easy public access to the circulating library at entry level. The stacks and administration offices are situated on the upper levels, with staff areas surrounding the climate-controlled, structurally reinforced stack area.





11



12



13

- 11 Typical workstation detail
- 12 Research library entrance from Healy Hall
- 13 Lower level library
- 14 Research reading room, lower level library
- 15 Electronic information center



14



15

## Stadtportalhäuser

Design 1991–1994

Frankfurt-am-Main, Germany

Bosch Corporation

2,000,000 square feet

This project is located at the intersection of a major boulevard leading into the city of Frankfurt, at the edge of the international exposition center. The design resolution was influenced both by the importance of maintaining the site trees and an open park space and by the existing railroad bridge, road system, and exposition structures.

The complex volumetric configurations were specific responses to the site and program, which included a museum and office building for the Bosch Corporation, two speculative office buildings, and a hotel. Essential to the composition are the two similar wedge-shaped office buildings whose facades define the gate, and the dissimilar masses that extend from these facades to either side of the boulevard.

The project was the first European competition for the Gwathmey Siegel office; the scale and complexity of the architectural and urban resolutions represent a creative learning experience and provide an excellent resource for future investigations.

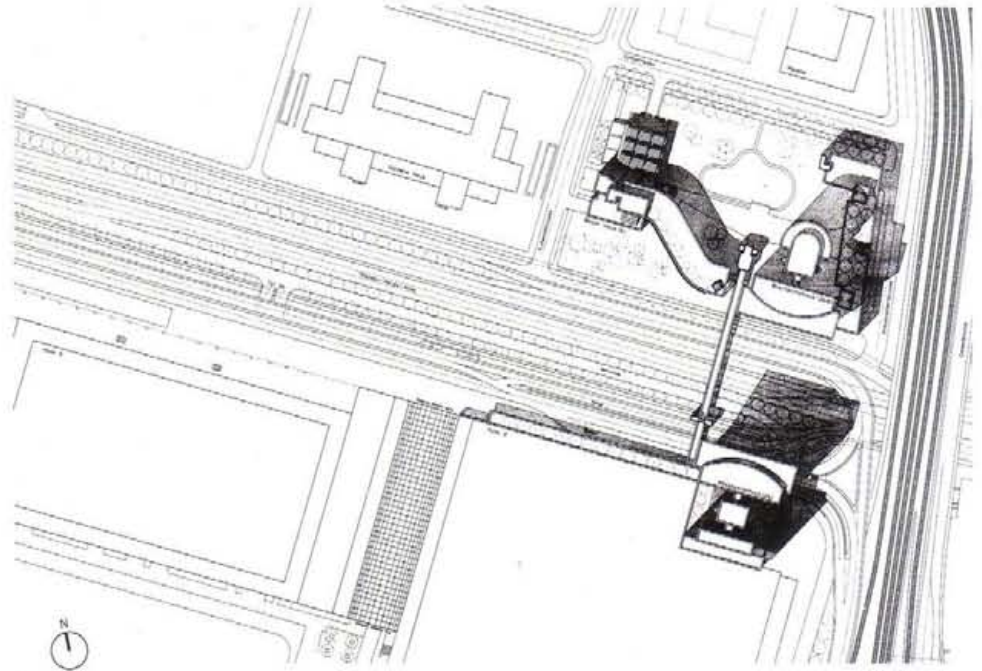

1



2

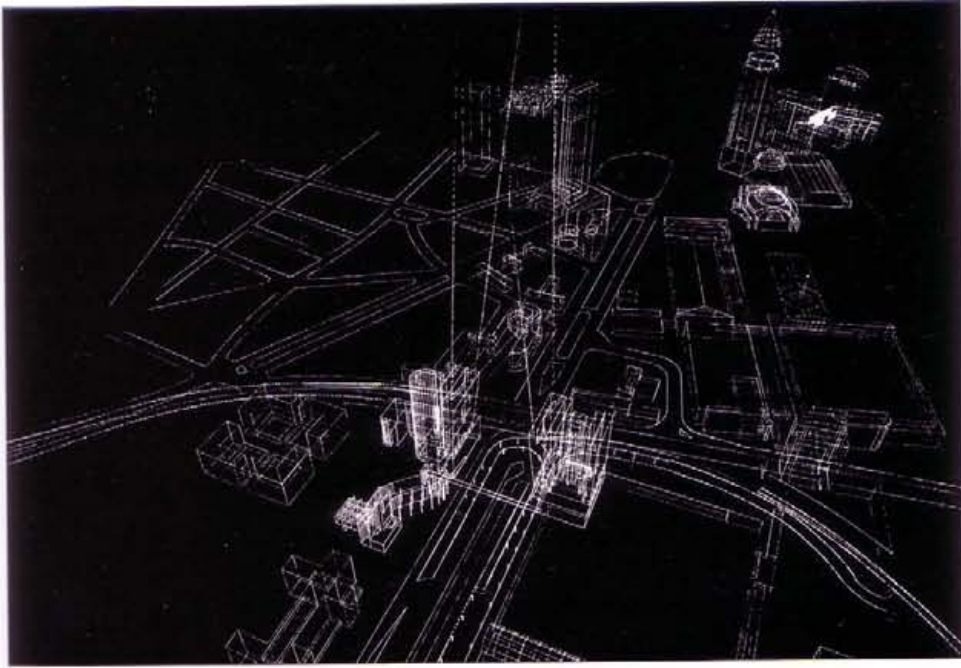

- 1 Site plan
- 2 Aerial view of model from north showing museum park, Bosch Corporation building, two speculative office buildings, and hotel
- 3 Design intention
- 4 Aerial view of model from south



4

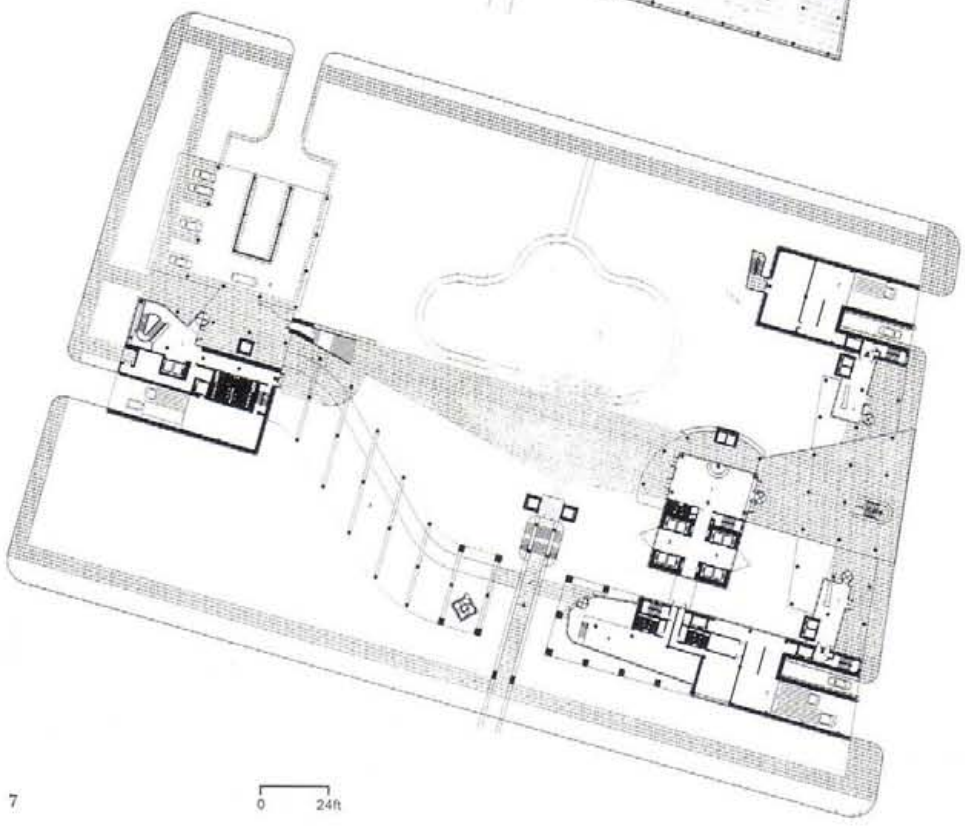
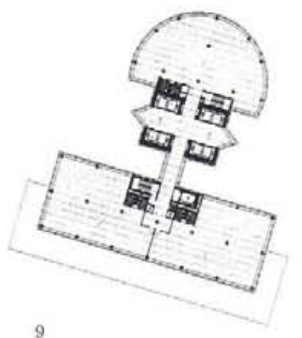
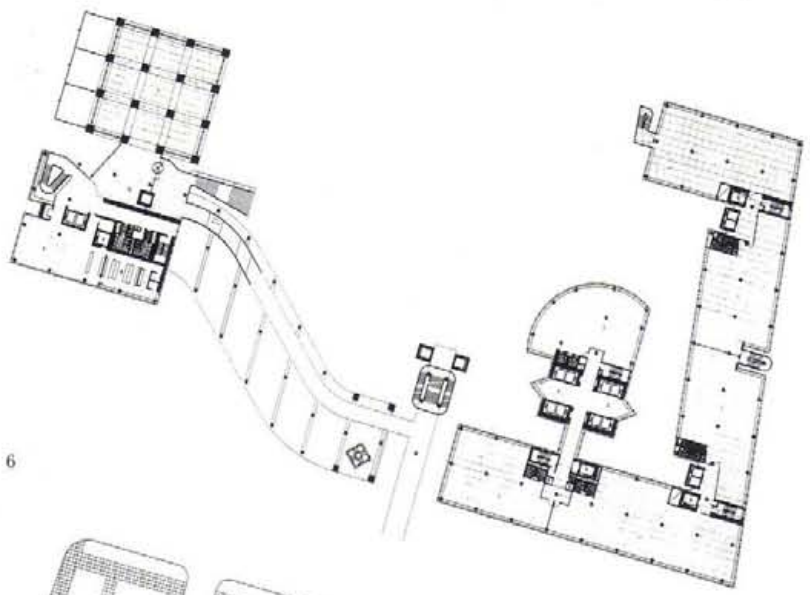
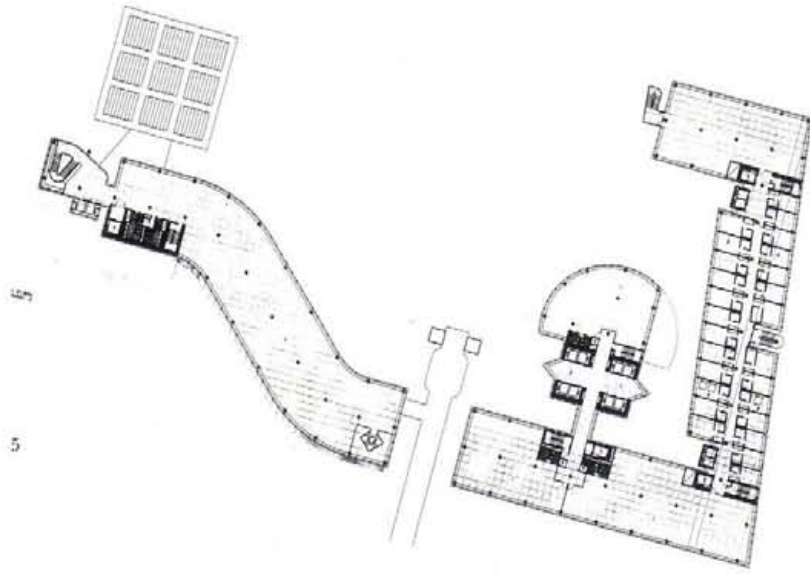

- 5 Third level plan
- 6 Second level plan
- 7 Overall ground level plan
- 8&9 Typical upper level plans of north-site office building
- 10 Ground level view of model from east
- 11 Aerial view of model from north



11 Ground floor lobby  
Opposite:  
Second level reception







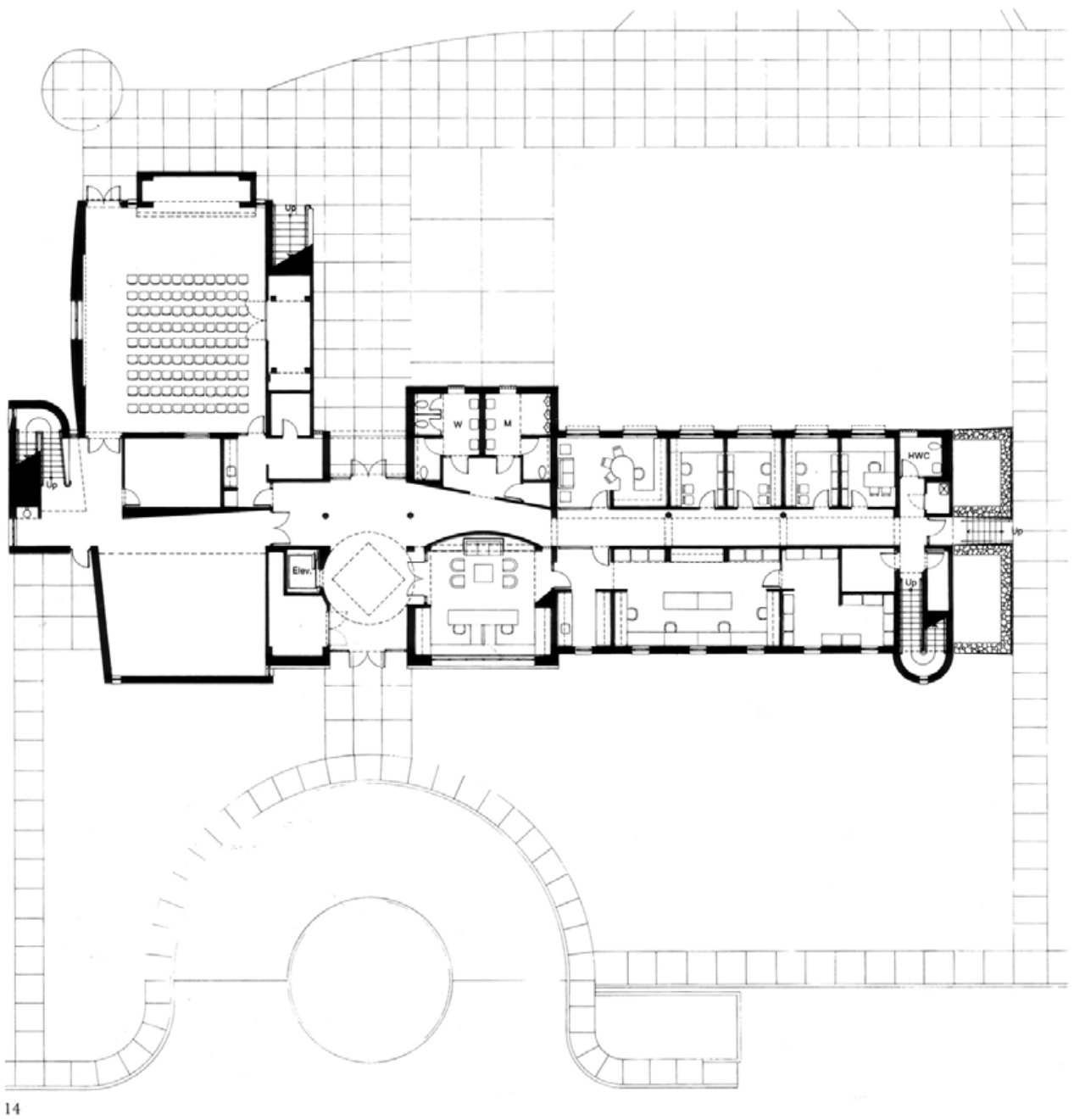
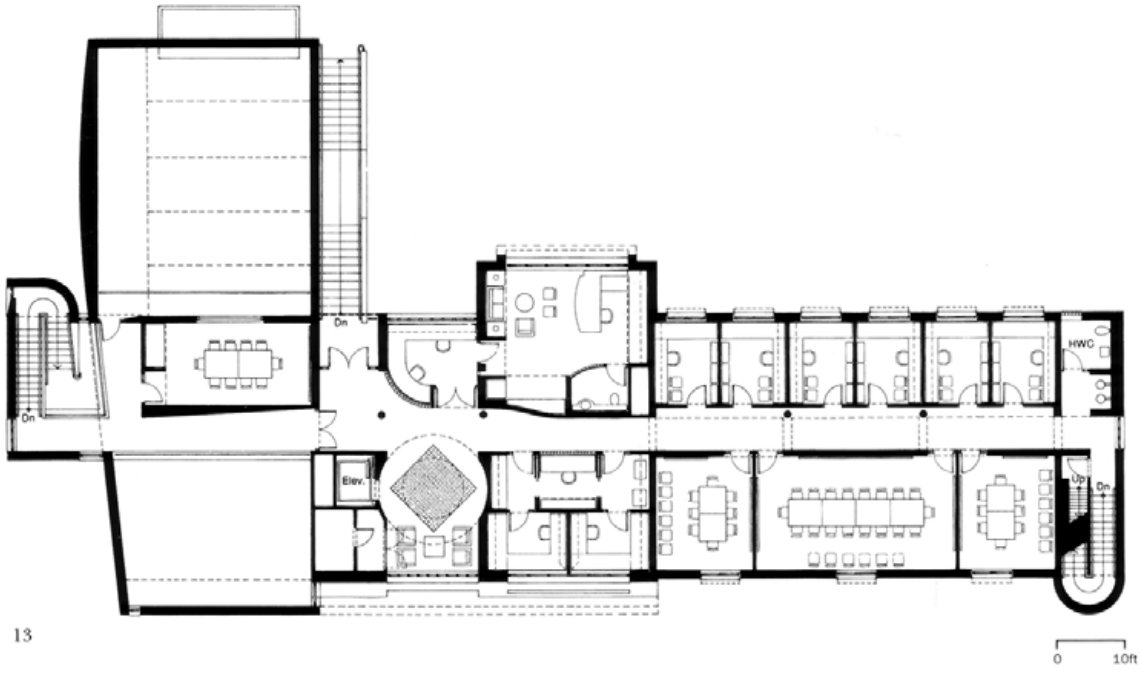



- 13 Second level plan
- 14 Ground level plan
- 15 Exhibition gallery
- 16 President's office

15



16

- 17 Typical classroom
- 18 Stairwell



17



## Broad Hall Classroom Building

The 14,500-square-foot Broad Hall houses classrooms, faculty offices, a language center, a computer center, and psychology and anthropology laboratories. The building is sited to complete the previously undefined academic quadrangle, to reinforce the corner of Pellisier Mall, and to define, with Broad Center, the new Pitzer Lawn. This contextual intervention integrates architecture with landscape design, enriching and ordering disparate existing conditions as well as establishing a dynamic new sense of place.



19



20

- 19 View from existing building to campus green
- 20 Bridge to new building
- 21 Broad Hall from campus
- 22 Campus green facade



21



22

- 23 Longitudinal section AA
- 24 Lateral section BB
- 25 Lateral section CC
- 26 Second floor gallery
- 27 View from stair to campus tower
- 28 Second level plan
- 29 First level plan

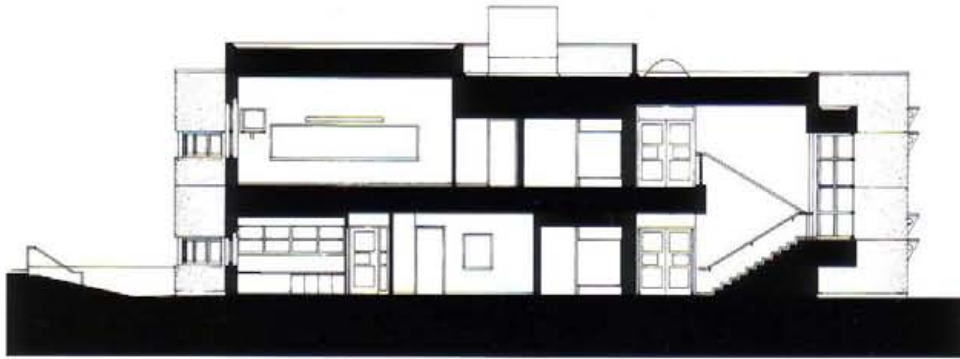

23



26

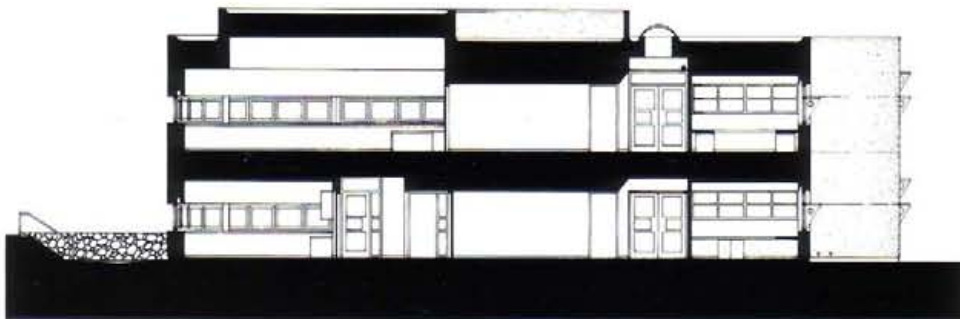

24



27

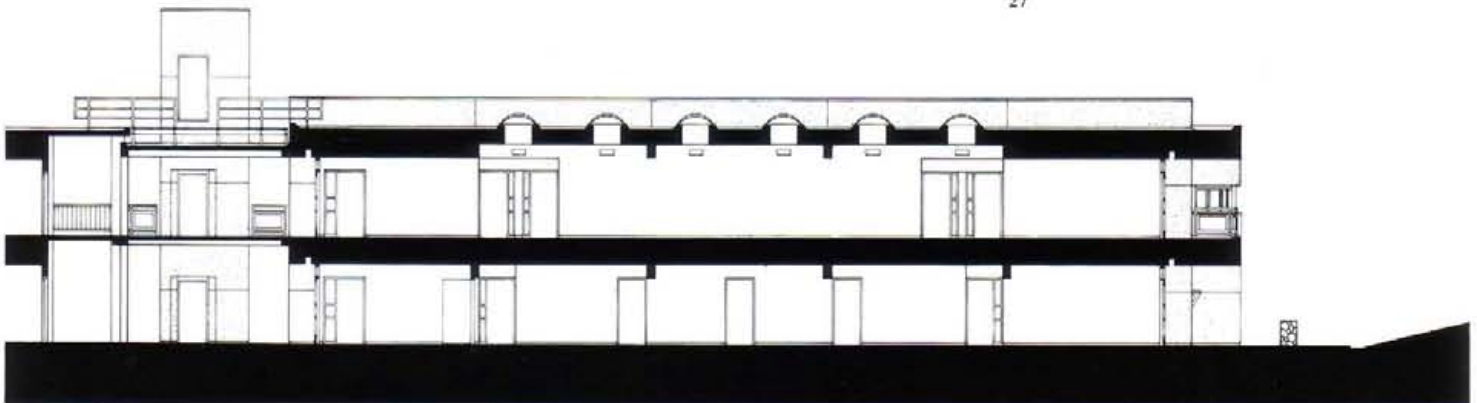

25



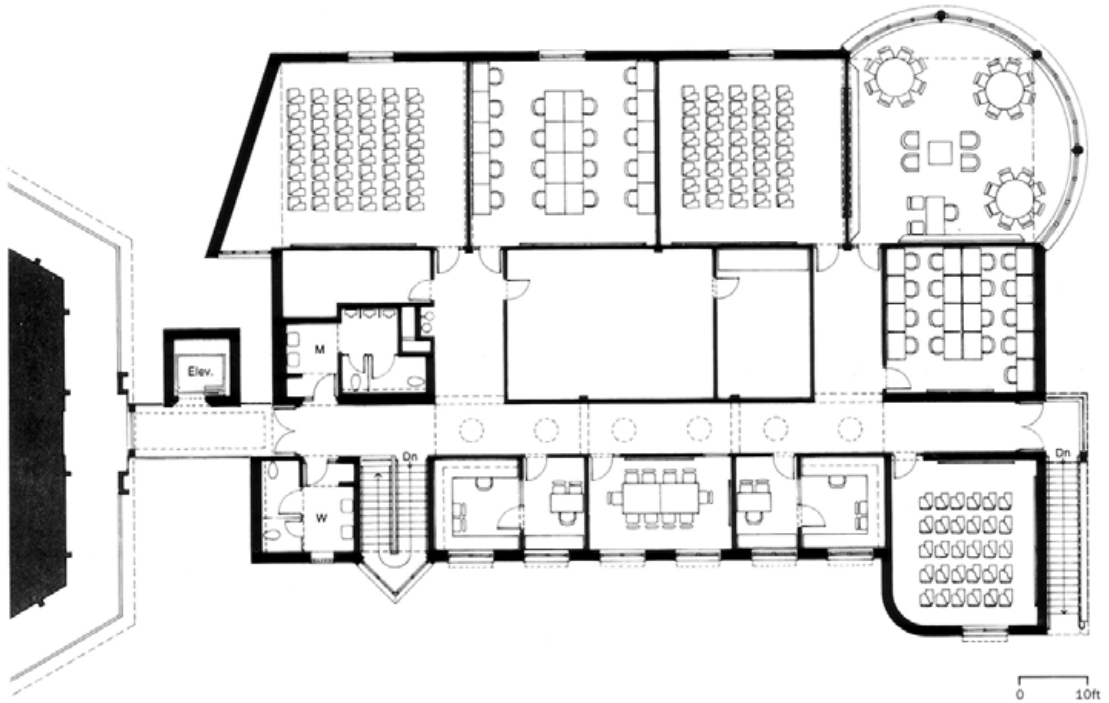

28

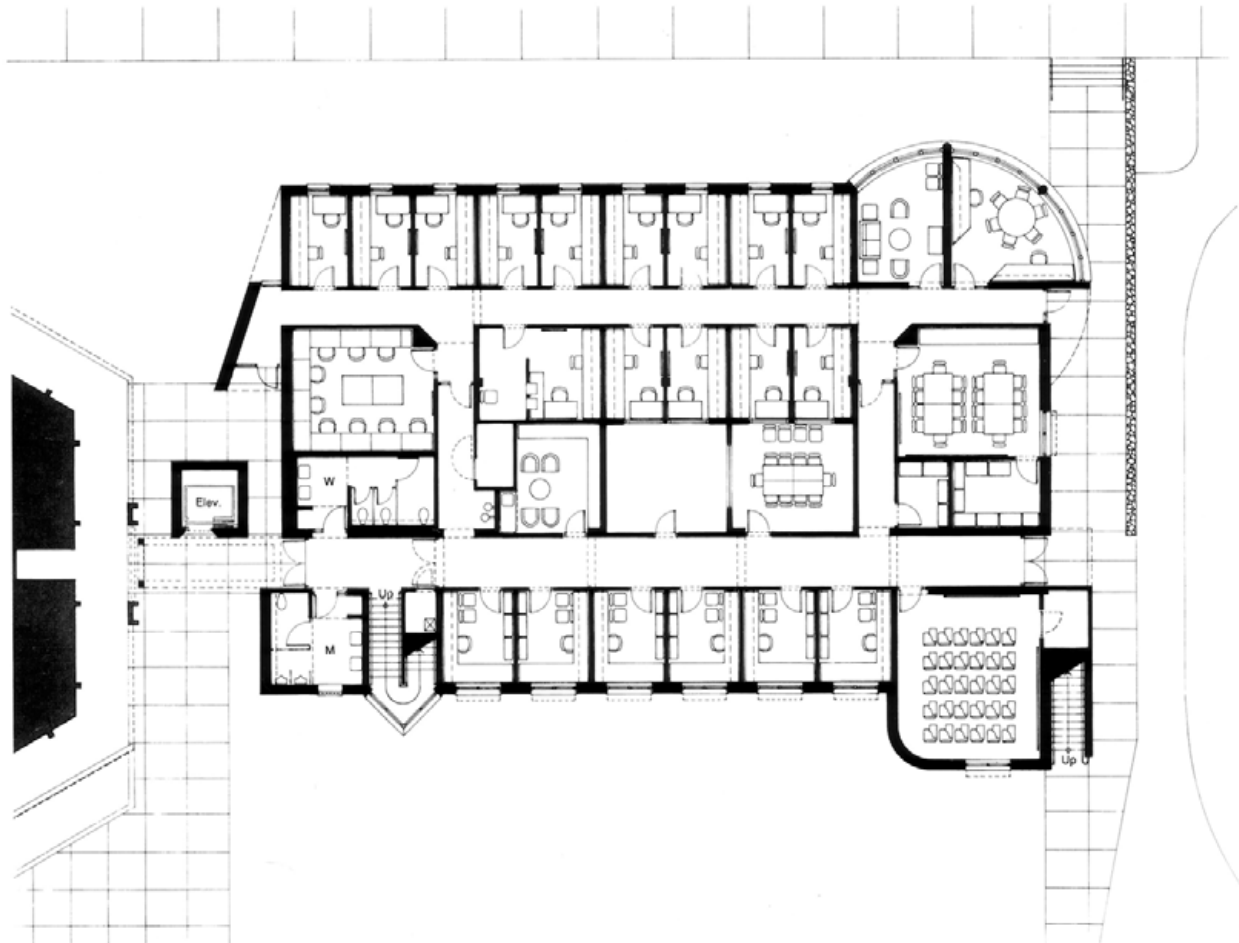

29

# Gold Student Activity Center



30



31



32

The third building is the Gold Student Activity Center, a 12,000-square-foot two-story structure which establishes a second major outdoor cross-axis on the campus. The program includes a new snack bar and pool/garden terrace, as well as a subdividable assembly space, student offices, a post office, lounges, lockers, and a two-story active recreation room.

- 30 Facade detail
- 31 Exterior view
- 32 View of entry facade
- 33 Longitudinal section AA
- 34 Lateral section BB
- 35 Lateral section CC



33

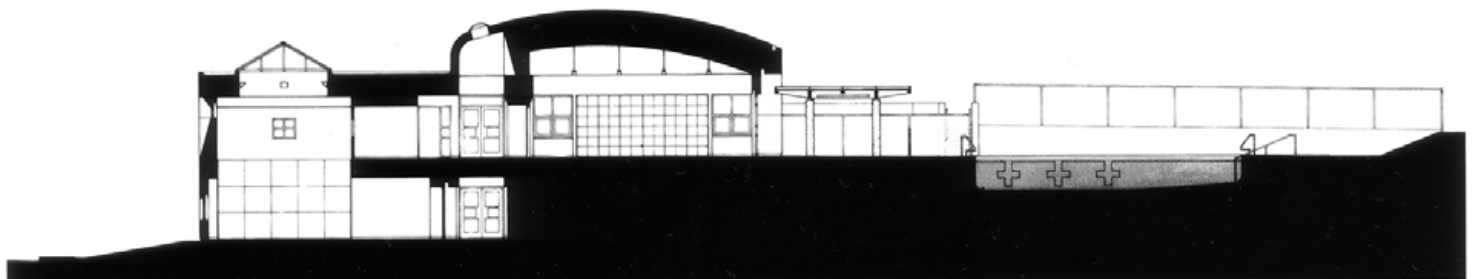

34

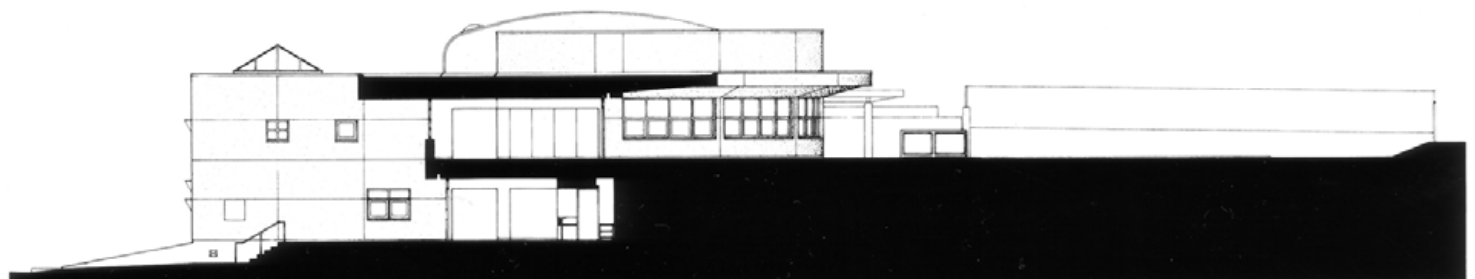

35

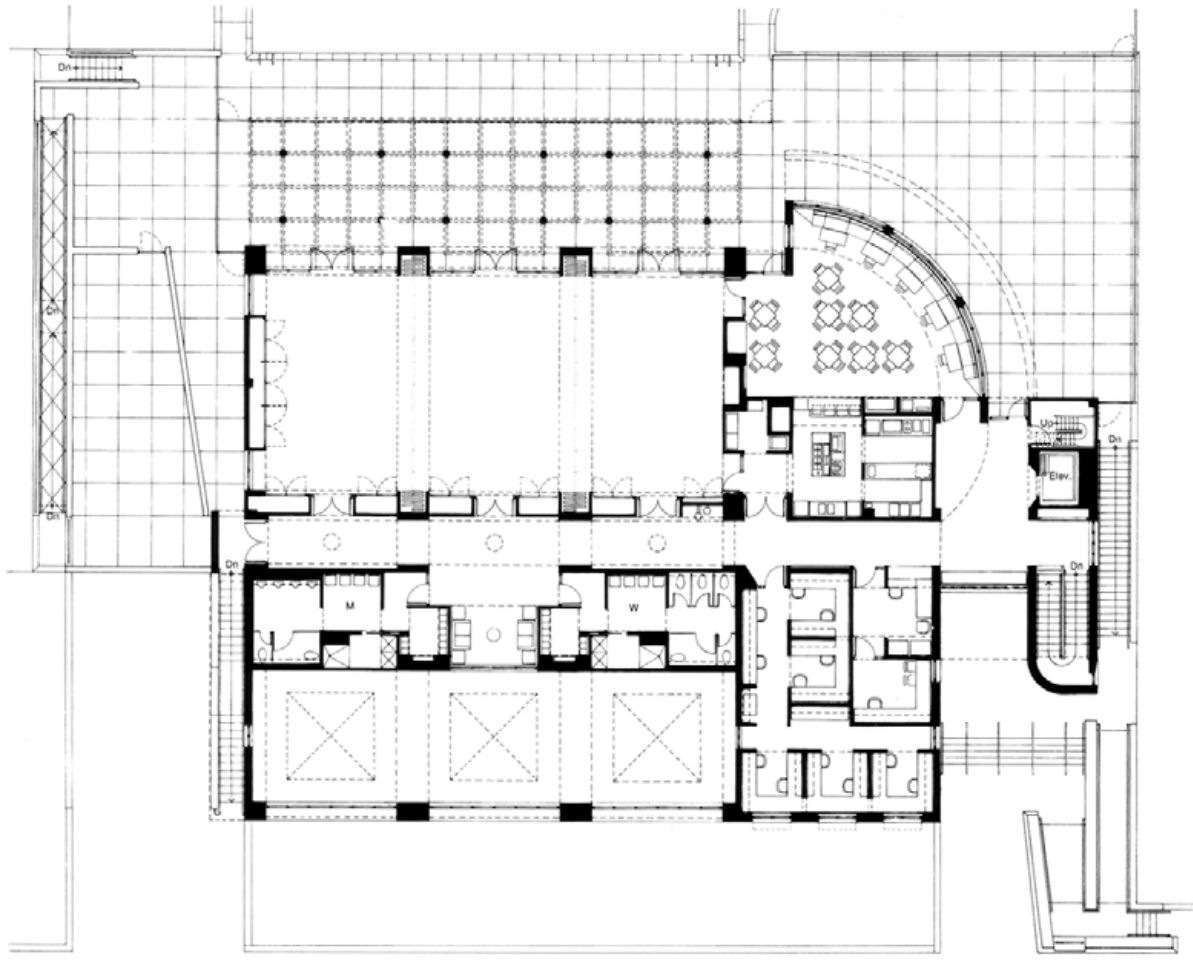

36

0 10ft

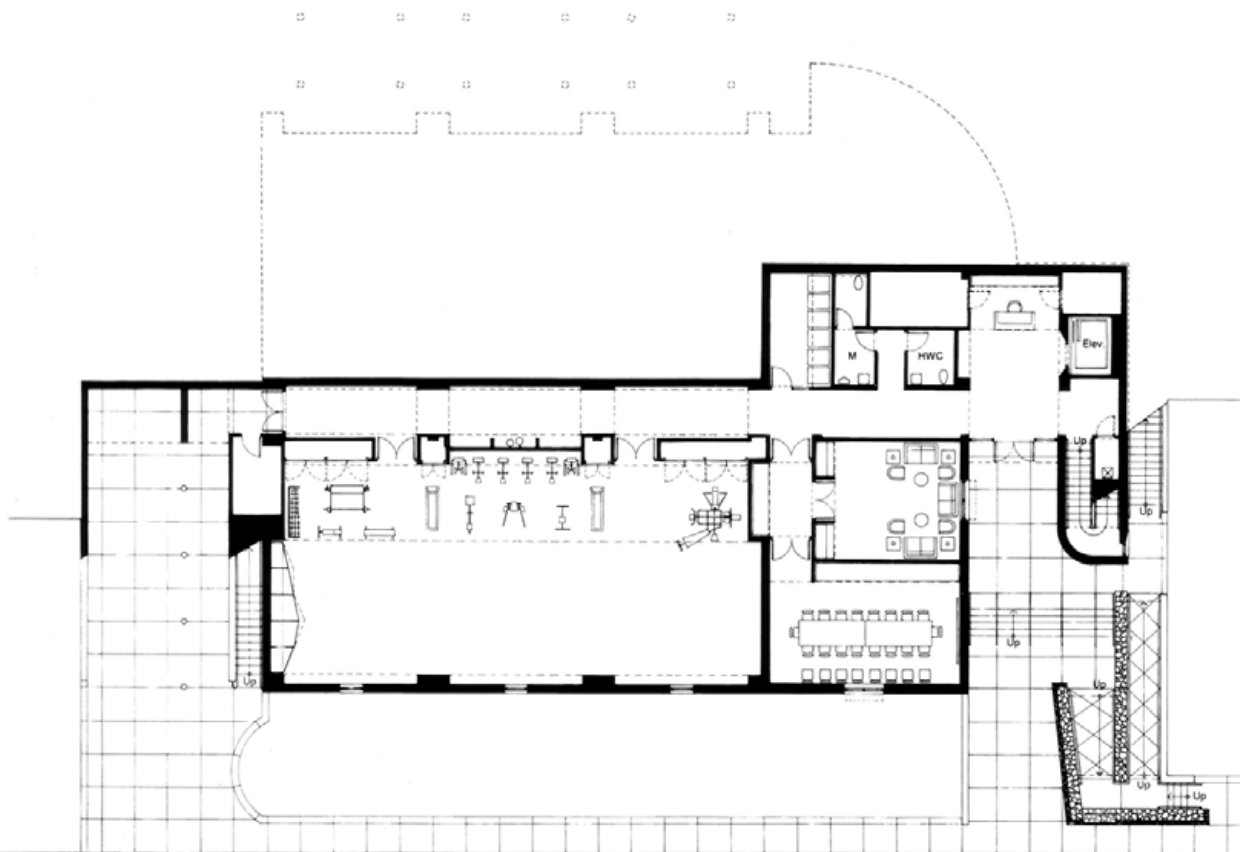

37



38

- 36 Second level plan
- 37 Ground level plan
- 38 Second floor gallery
- 39 Flexible exercise space
- 40 Snack bar



39



40

## Henry Art Gallery Renovation and Addition, University of Washington

Design/Completion 1993/1997

Seattle, Washington

University of Washington, Henry Art Gallery

49,000 square feet

Precast concrete panels, board-formed concrete, textured stainless steel,  
aluminum windows and skylights

Terrazzo, maple panels

The central issue in this project is that of intervention into an existing context and the multiple ramifications that arise. Replication is not an option. The history of architecture has always been enriched through change and dialogue: additions to, interventions in, and renovations of existing buildings. The formal question is: how to reinforce and enrich the original through a comprehensive and interpretive intervention, understanding both the history and the formal implications, as well as being able to analyze the existing conditions, to foster a positive interpretation?

In the case of the Henry Art Gallery, the intent was to maintain and enhance the presence, solidity, and density of the original small masonry building, which was overwhelmed by two large adjacent buildings and compromised by a pedestrian bridge that was perpendicular and tangential to the front facade, diminishing the entry and its sense of place on the site.

From the outset, the fundamental idea was to recast the existing landscaped, bermed site into a new campus entry that added content, context, expectation, and significant visual penetration, reinforcing both the existing statue of George Washington and the facade of the Suzzallo Library, which defined the center of the campus. Also, there was a determined intention to separate the existing Henry Art Gallery and the new addition from the neighboring structures, affording a legitimate transition, an architecturally defined new sense of place, an expectant and enriched entry sequence, an integrated site/circulation/building context that simultaneously engaged art and architecture.

The addition is formed in response to the existing building, the site, and the program. In one sense, the formal idea begins with a linear structure set behind and parallel to the existing building, between it and the existing wall of the underground parking structure. In order to afford pedestrian site penetration, a portion of the linear structure was "compressed" below grade, leaving fragments of the original, in the form

*Continued*

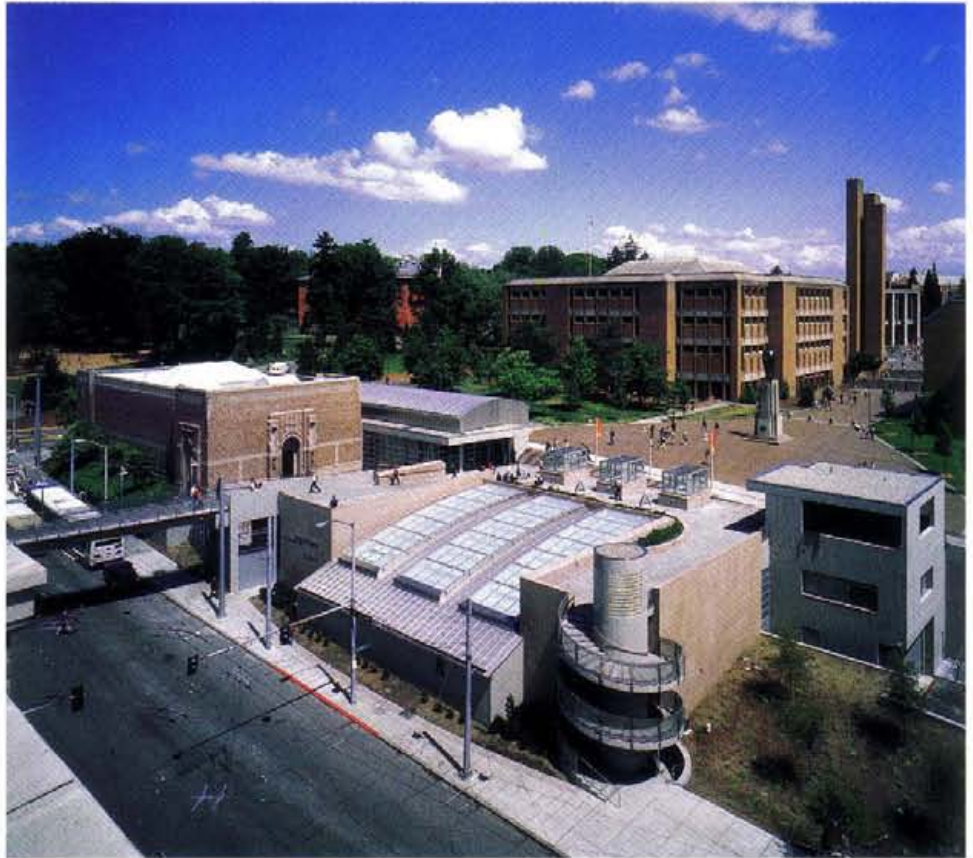

- 1 Aerial view
- 2 Original building and addition from pedestrian bridge
- 3 View of addition over skylights from plaza
- 4 Site plan
- 5 Site section
- 6 Entrance from Red Square

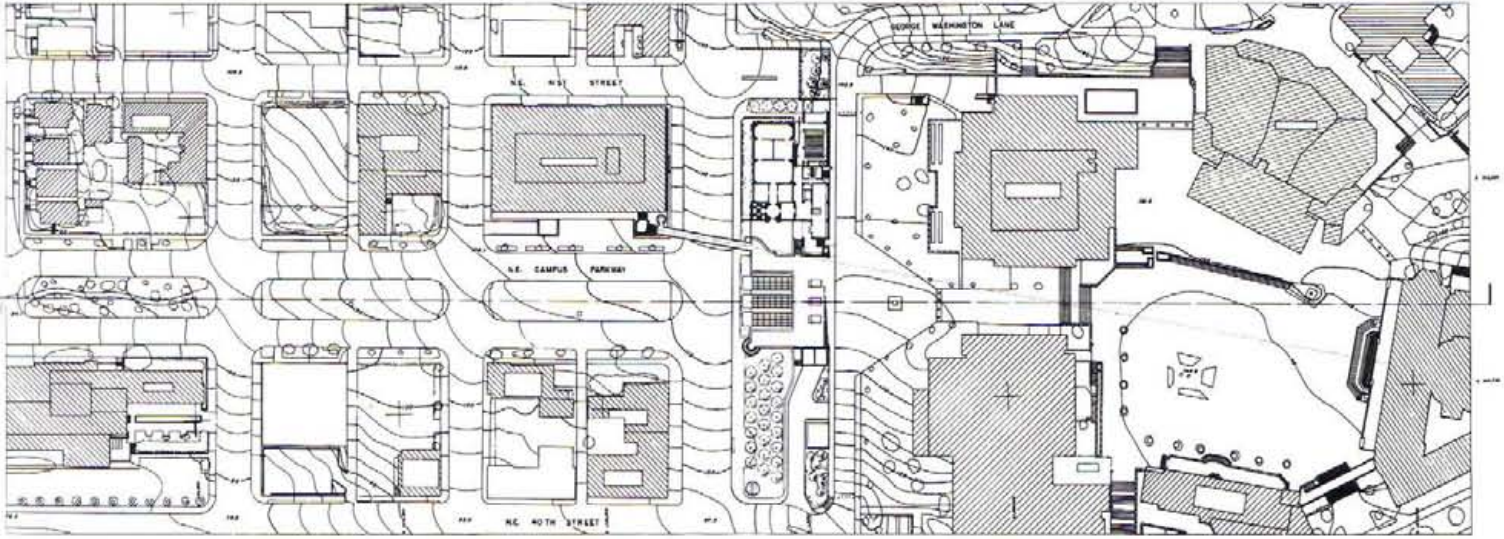

4

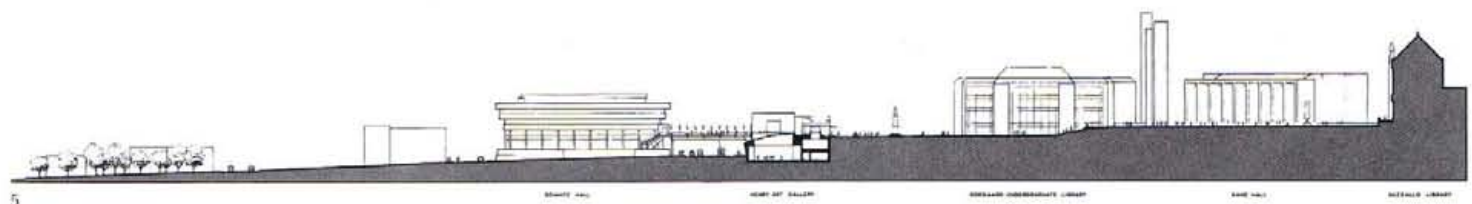

5



6

- 7 Plaza stair from 15th Street
- 8 Entry from George Washington Lane
- 9 Campus Parkway
- 10 View of original building and addition from 15th Street

of three skylights which articulate the "gatelike" porosity of the site, as well as affording natural light to the administrative offices below. From this compressed and limited site, the remainder of the building is extruded forward to 15th Avenue in the curved roofed form to accentuate the silhouette, the foothill nature of the site, and the counterpoint to the original Henry, and as a memorable form to be re-experienced from within, as the new main gallery.

In another sense, one could describe the result as a carving away of a solid to reveal composite fragments, all interacting with the original Henry to resite it, as the asymmetrical though primary object, in a new contextual frame that unifies the multiple site and architectural issues at the end of Campus Parkway.

Finally, the result could also be defined as an architectural collage, unifying disparate elements in both counterpointal and asymmetrical variations that ultimately re-establish the primary site axis to Suzzallo Library, reconcile the vertical transition from 15th Avenue to the plaza level, and integrate the original Henry facade with the new sculpture court and entry to the campus and the museum. The forms, as fragments, are implicit in their implications as spaces, but being abstract in their ambiguity to not directly reveal that space. Thus, a sense of anticipation, sequential revelation, and memory becomes as crucial to the experience as the fact.



7

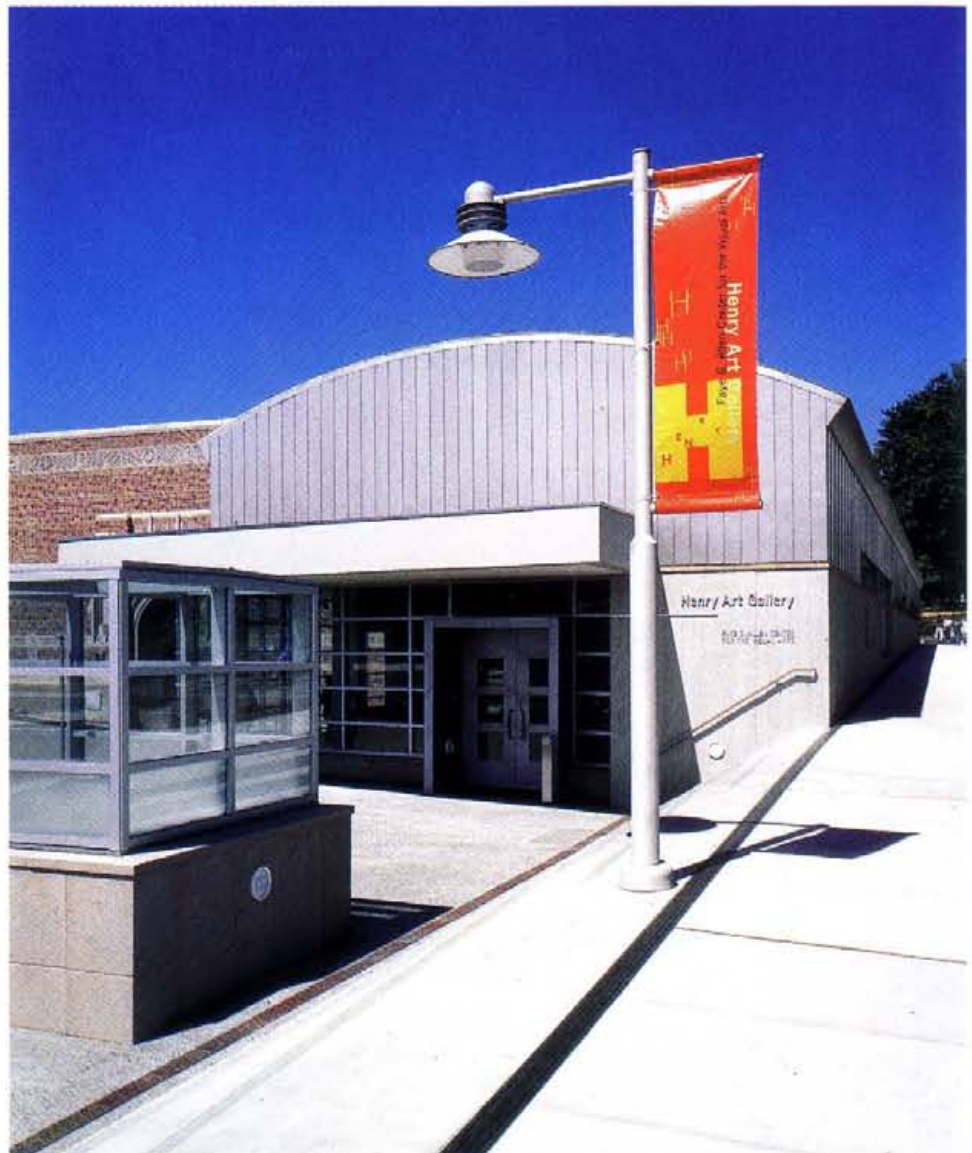

8





9



10

- 11 Level three plan
- 12 Level two plan
- 13 Level one plan
- 14 Main stair on cross axis to entry of original building
- 15&16 Main gallery

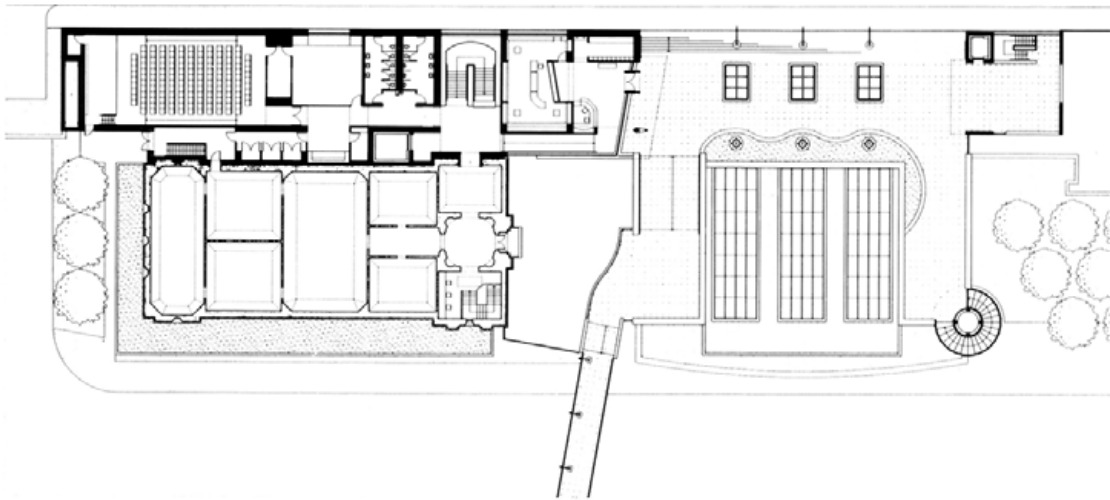

11

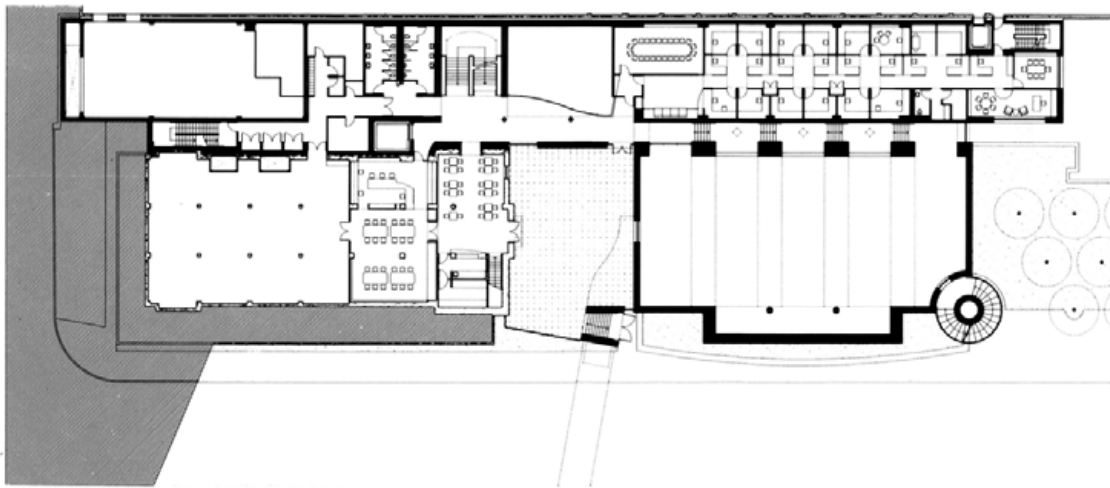

12

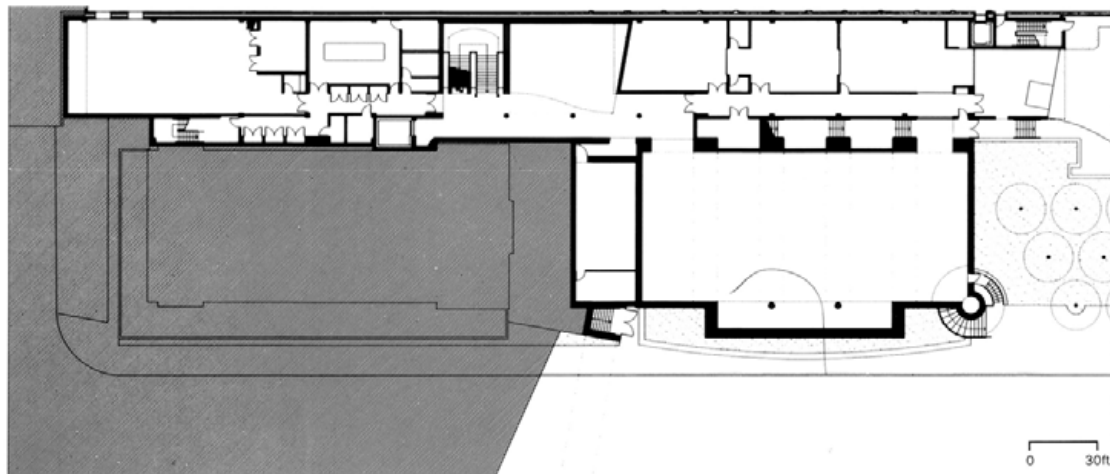

13

0 30ft



14



15



16

17-20 Sections

- 21 Lecture theater
- 22 Cascading stair from main gallery
- 23 Entry lobby and store
- 24 Intermediate circulation gallery
- 25 Entrance corridor to main staircase

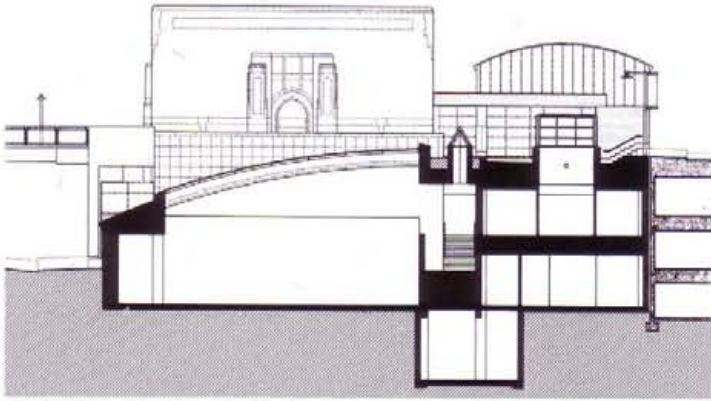

17

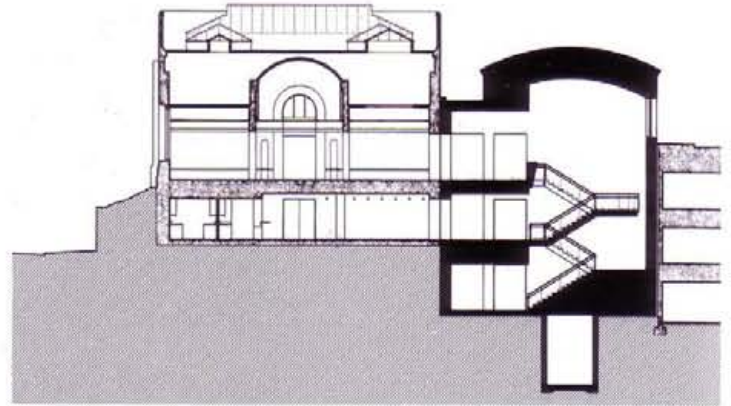

18

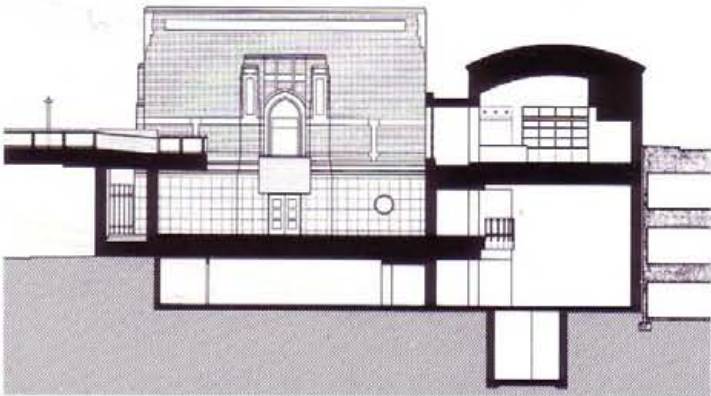

19

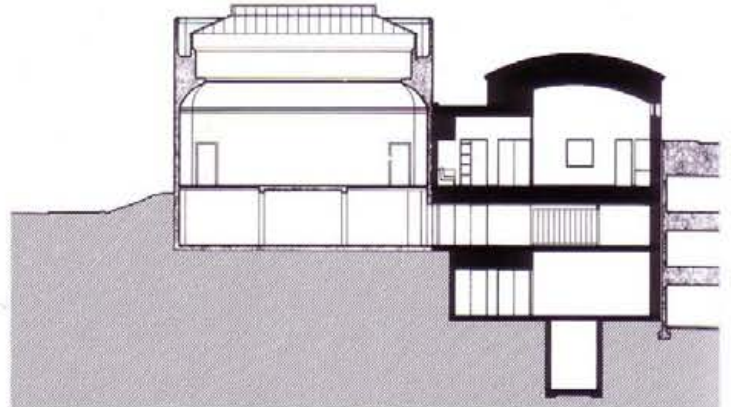

20



21



22



23



24



25

- 26&27 Northeast double-height gallery
- 28 Main gallery
- 29 Restored entry rotunda of original building



26



27



28

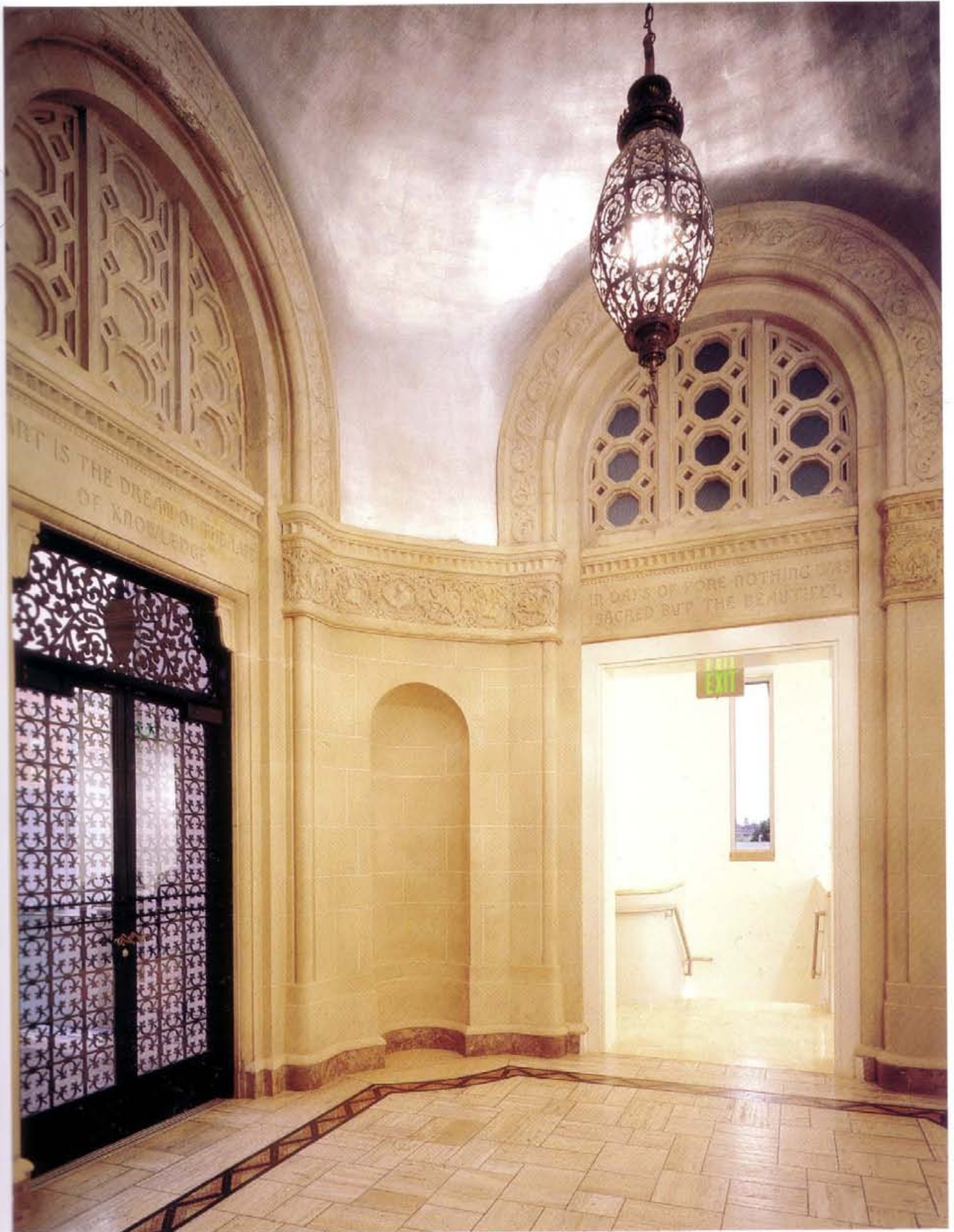

## Hilltop Residence

Design/Completion 1992/1997

Austin, Texas

Private owner

28,000 square feet

Granite, stucco, lead-coated copper, stainless steel, steel windows

Integral color plaster walls, maple, cherry, granite, limestone and greenstone floors, pearwood millwork, pearwood and maple cabinetwork

This residence is located on a wooded hilltop site with views of downtown Austin and the University of Texas. The parti exemplifies the idea of a building in, rather than on, the landscape. By raising the grade on the east side of the site, the transformation of "carving" the building/site as an integrated engagement enriches the total experience, as well as redefining the usual "house on top of the hill."

The program's primary focus is on family life, with secondary emphasis on entertainment and conference functions. The building is organized around a horizontal spine, with the "family house" to the northwest and the "entertainment house" to the southeast. These components are treated as complex figural objects within the landscape.

The building defines the site on the west by horizontal extension at the lower level and upper level entry courts, on the south by a lower level play court, and on the east by expansive lawn and pool terraces. A two-story covered arcade engages the lawn/terrace area and connects the main house on the north to the entertainment/guest house on the south.

The full extent of the house is visible only from the air. From the ground it reads as layers of integrated building and landscape fragments comprehended only through memory and speculation as one moves around the site from inside to outside.

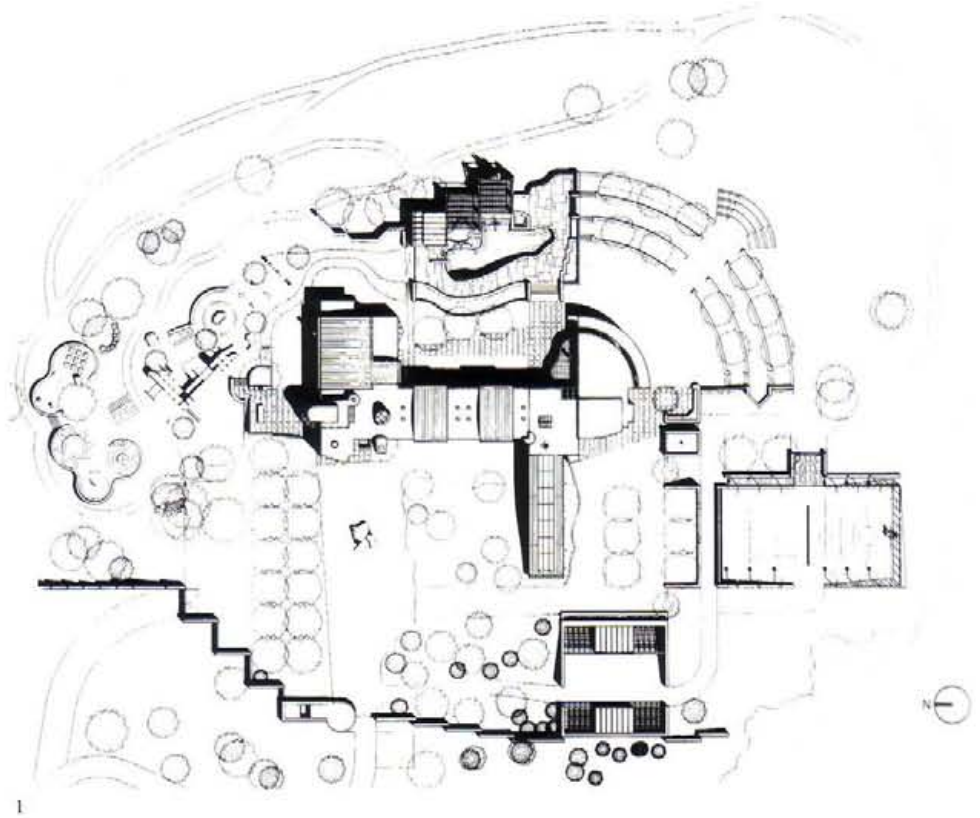

1



2



- 1 Site plan
- 2 Aerial view looking south
- 3 Site model

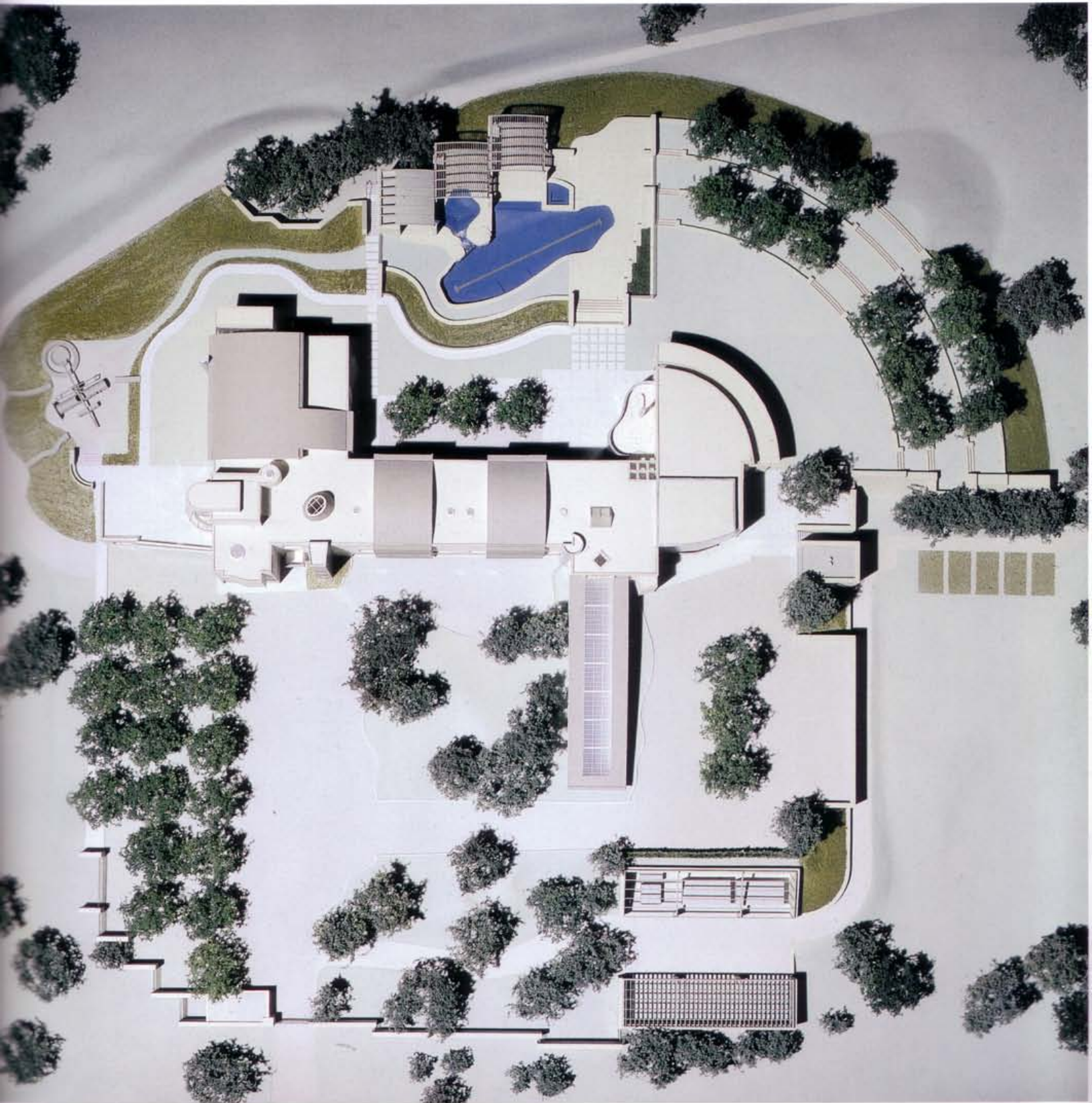

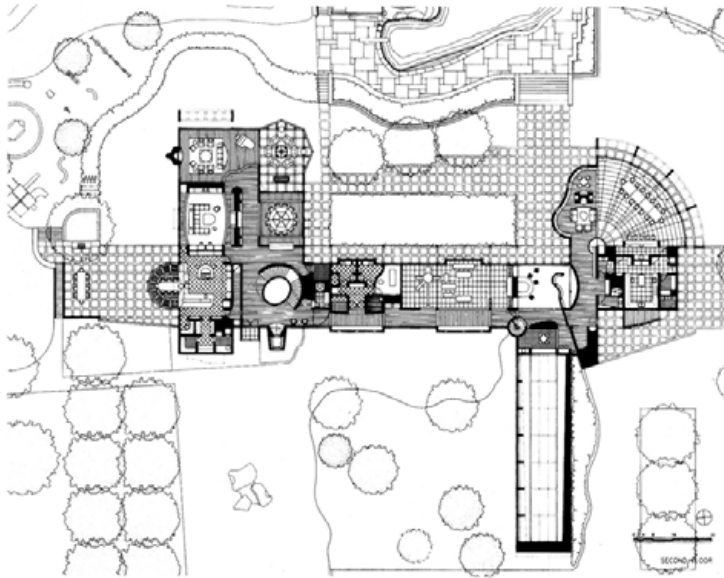

4

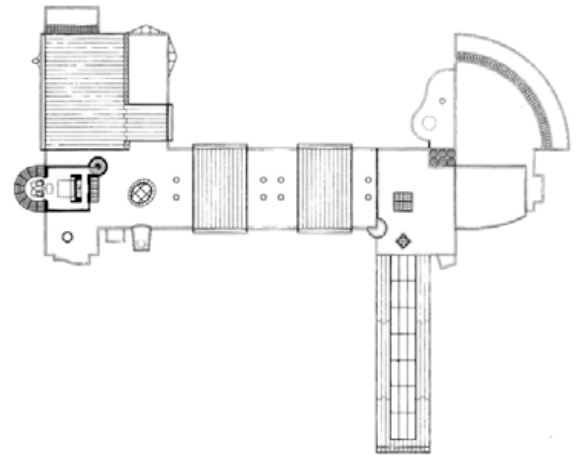

5

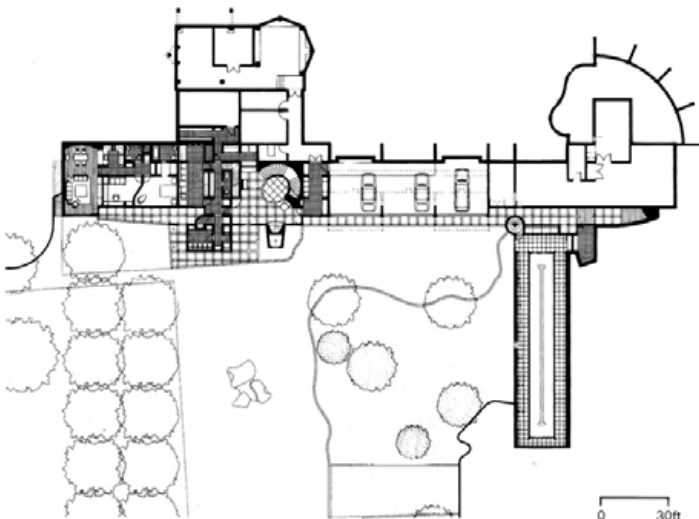

6

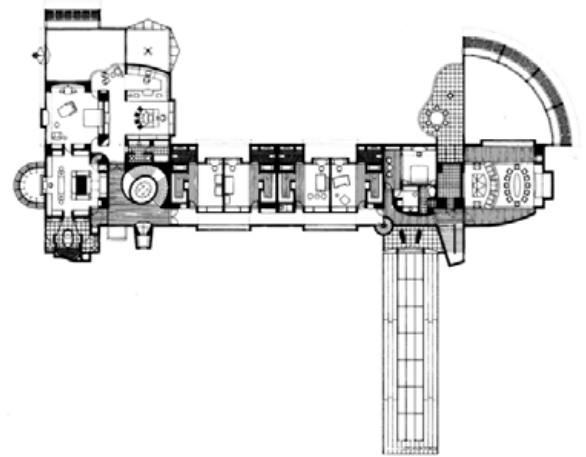

7

- 4 Second floor plan
- 5 Fourth floor plan
- 6 First floor plan
- 7 Third floor plan
- 8 Aerial view looking southeast
- 9 Aerial view looking west



8



9

## The Museum of Contemporary Art

Design/Completion 1993/1996

North Miami, Florida

The Museum of Contemporary Art

23,000 square feet

Painted stucco, groundfaced concrete block, galvanized corrugated metal panels, steel

This modest museum is situated between City Hall and the proposed Police Headquarters, transforming an existing parking lot into an urban art plaza and redefining the town center as a cultural complex.

The building is composed of four articulated and interconnected elements which are assembled as a composition of cubist objects to form a dynamic visual collage that provokes curiosity, engagement, and an appreciation of both art and architecture.

The structure frames an exterior sculpture courtyard which provides pedestrian circulation to all parts of the museum, and creates a visual dialogue between the Police Building and City Hall. The public plaza is outlined by a 28-foot grid of 40-foot-high palm trees at 125th Street, and by the reflecting pool, studio, and museum entry arcade on the south side.

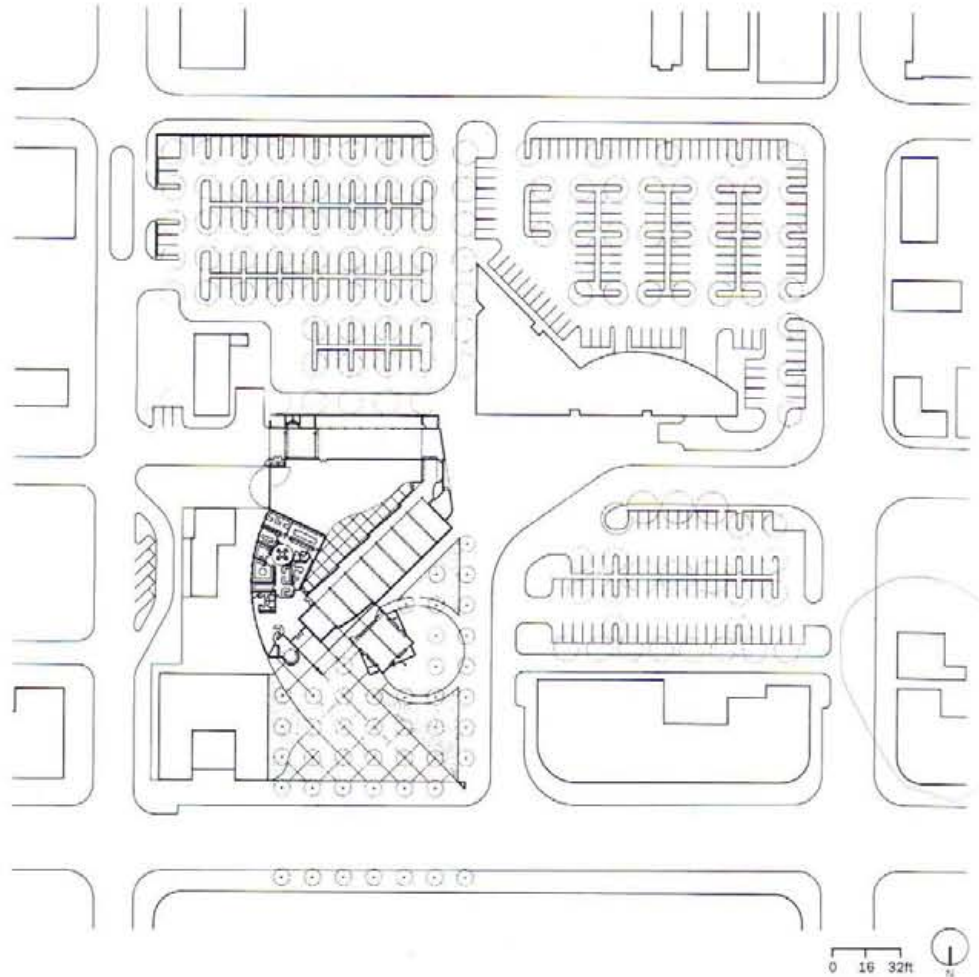

1



2

- 1 Site plan
- 2 Entry facade across public plaza
- 3 West entry arcade detail
- 4 Detail of west gallery corner with studio in background
- 5 Axonometric
- 6 East facade with museum store and entry arcade



3



4

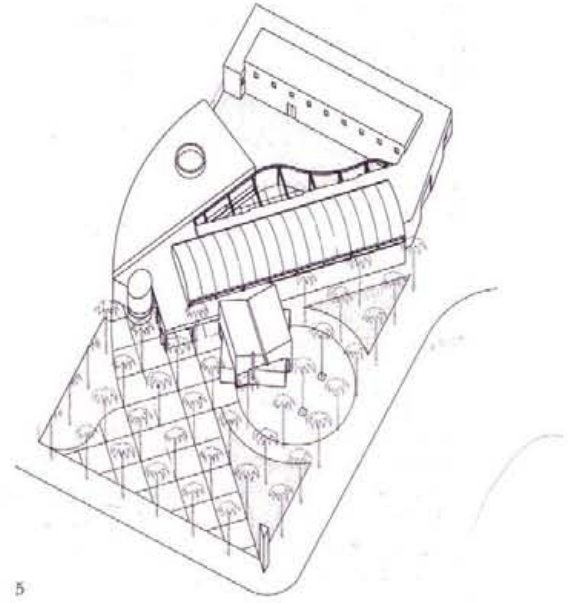

5



6

- 7 Entry arcade
- 8 Gallery from lobby
- 9 Gallery arcade
- 10 Gallery



7



8

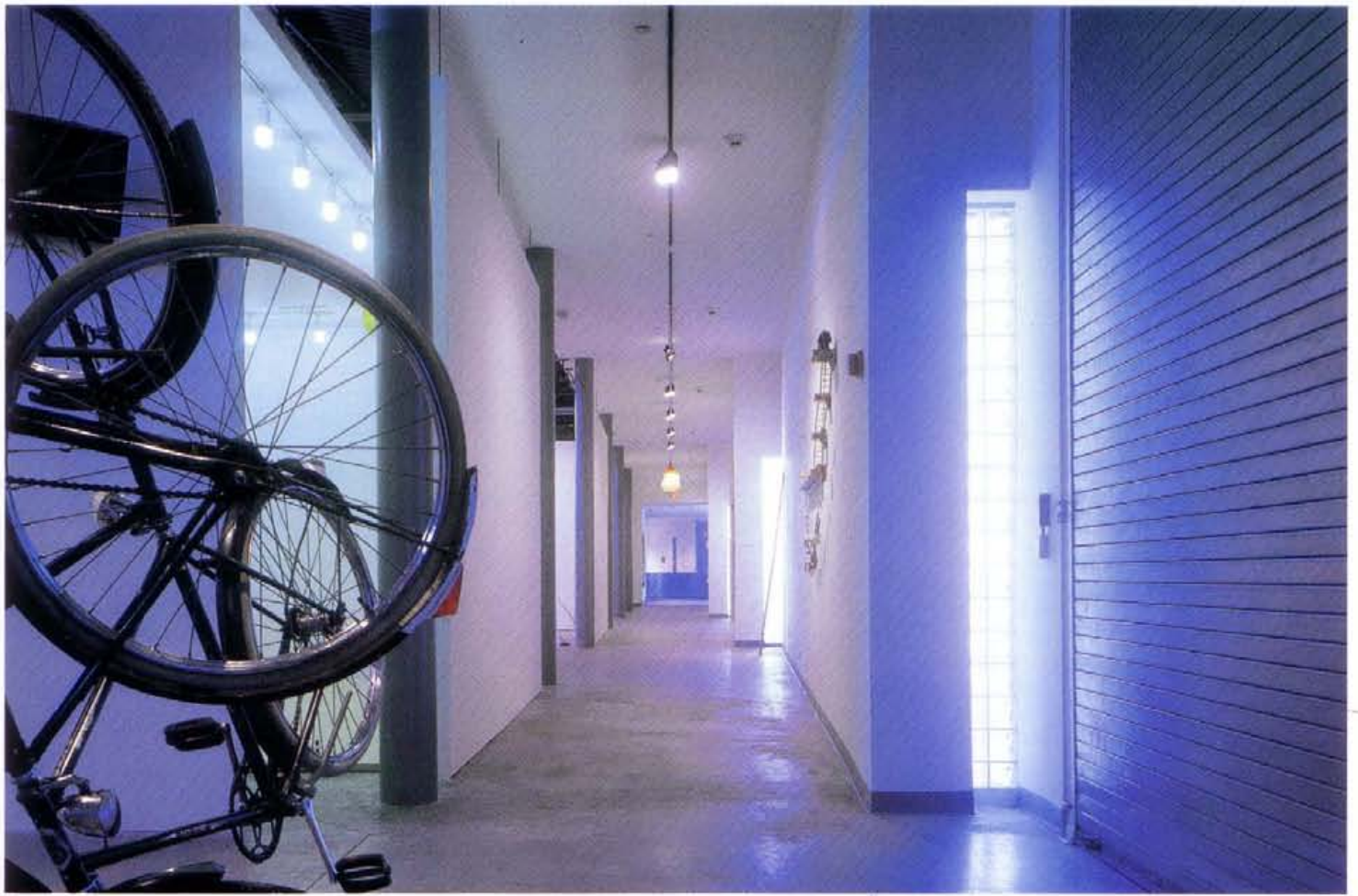

9



10



18



19

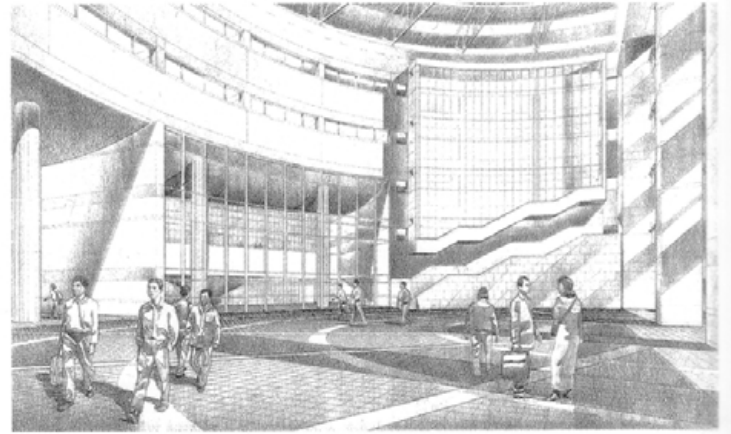

20



21



- 18 Section through primary entry sequence
- 19 Sunken entry plaza
- 20 Campus Center atrium
- 21 South garden looking at Campus Center
- 22 South garden looking south
- 23 Sunken entry plaza
- 24 Campus Center atrium
- 25 South garden viewed from terrace level
- 26 School of Engineering: open atrium



22



23



24

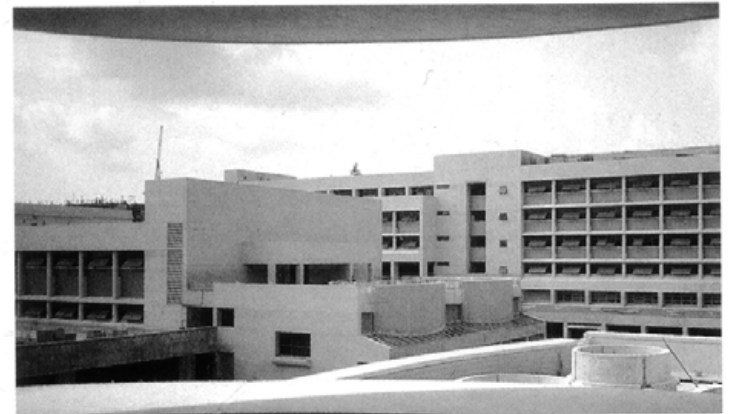

25



26

## 21 International Holdings Inc. Offices

Design/Completion 1993/1994

New York, New York

21 International Holdings Inc.

14,000 square feet

Maple ceilings, wall paneling, doors, ducks, and floors; beige marble floors; cherry cabinetwork; plaster walls; brushed aluminum ceilings

21 International Holdings is a multifaceted investment company whose 14,000-square-foot corporate offices in the Seagram Building house a 3,000-square-foot chairman's suite, executive offices, foundation offices, and support spaces. The central design constraints were the building's landmark status and lease-mandated restrictions on interior renovations. The elevator lobby envelope was unalterable, as were the luminous ceiling with its 4-foot square grid and the perimeter walls, which required a minimum of 5 feet between them and the built-in furniture.

The design perceptually renders the space as "carved away" to reveal its archaeological precedents. The offices are read as a construction within a construction; the architects' interventions work in a point-counterpoint dialogue with the original elements of Mies's design. The luminous ceiling is treated as a constant plane of reference; interior walls are capped with a 12-inch-high glass transom that defines the limits of the new design and marks the transition from intervention to original construction.

The circulation space establishes the referential and dynamic aesthetic. The vertical/sectional articulation reinforces the hierarchical uses: reception, circulation, workstations, and perimeter office entries.

The subtle palette of colors and materials provides a strategic environment for unique pieces of furniture and objects of art. These include a dozen Hoffmann chairs, an Art Deco desk, Secessionist silver selected by the architect and client specifically for the space, and pieces from Chairman Marshall Cogan's private collection.

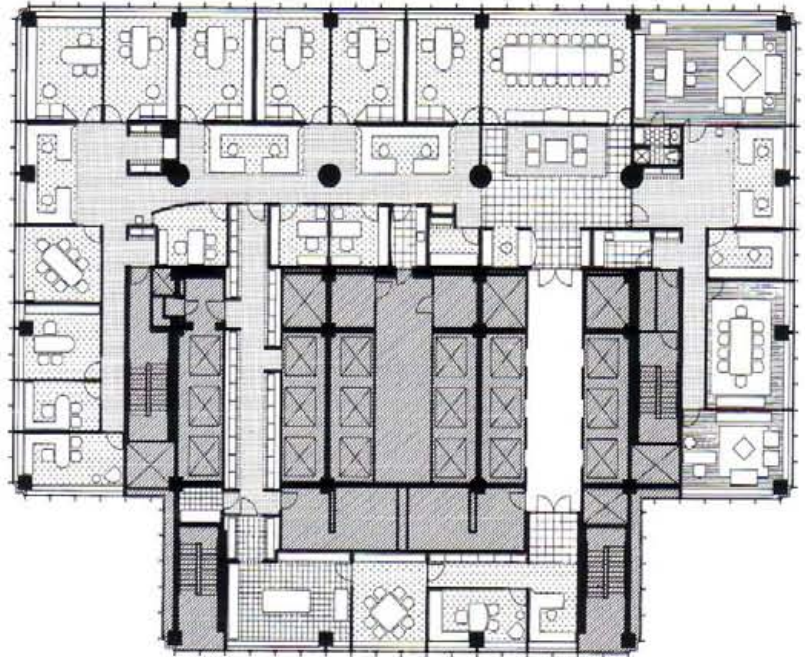

1



2

- 1 Floor plan
- 2 Reception area
- 3 Secretaries' workstations



- 4 Secretarial station outside chairman's office
- 5 Reception area
- 6 Principals' dining room
- 7 Boardroom with custom-designed table
- 8 Chairman's office



4



5



6



7



8

# San Onofre Residence

Design/Completion 1993/1997

Pacific Palisades, California

Private owner

15,000 square feet

Cleft-cut limestone, stucco, zinc metal panels, standing seam zinc roof, elastomeric PVC membranes, insulated laminated glass

This private residence is located on 1.5 acres at the end of Malibu Canyon. The two-level site suggested a binuclear parti. A three-story curved limestone pavilion, housing the main living spaces, sits on a promontory looking south and east towards Santa Monica, the Pacific Ocean, and the skyline of downtown Los Angeles. A three-story cube containing support space is embedded in the slope behind, overlooking the canyon to the west.

The canyon building is designed as an object in the landscape, anchoring and stabilizing the pavilion yet separate and unique in its organization and rendering. The curved limestone is intended to read as both a found object and a ruin, transforming the ordered disposition of the support building into an explosion of space and vistas revealed by the pavilion's glazed facade.

One enters on both levels between two elements in a horizontal and vertical circulation space facing the canyon to the west. The pavilion houses a double-height living room with views to Santa Monica and the Pacific Ocean. The kitchen and the master bedroom unite as an object that floats within the space of the pavilion, separating the living room from the dining room. The breakfast room penetrates the screen of the glazed facade and creates an outdoor terrace for the bedroom above. At ground level, the entertainment room becomes a giant *piloti*; recessed in the curve of the pavilion, it provides a shaded area near the swimming pool.

The canyon building is organized bilaterally and accommodates the exercise room on the ground level, the guest bedrooms at entry level, and an office/conference suite above at the master bedroom level. In the core, a screening room and archival library occupy the ground level. On the third level, the master dressing room and bathroom, opposite the offices, are rotated on axis with the bridge that returns to the pavilion.

The juxtaposition of shapes and textures creates a Cubist bas-relief, reiterated by an unexpected use of traditional and modern materials.

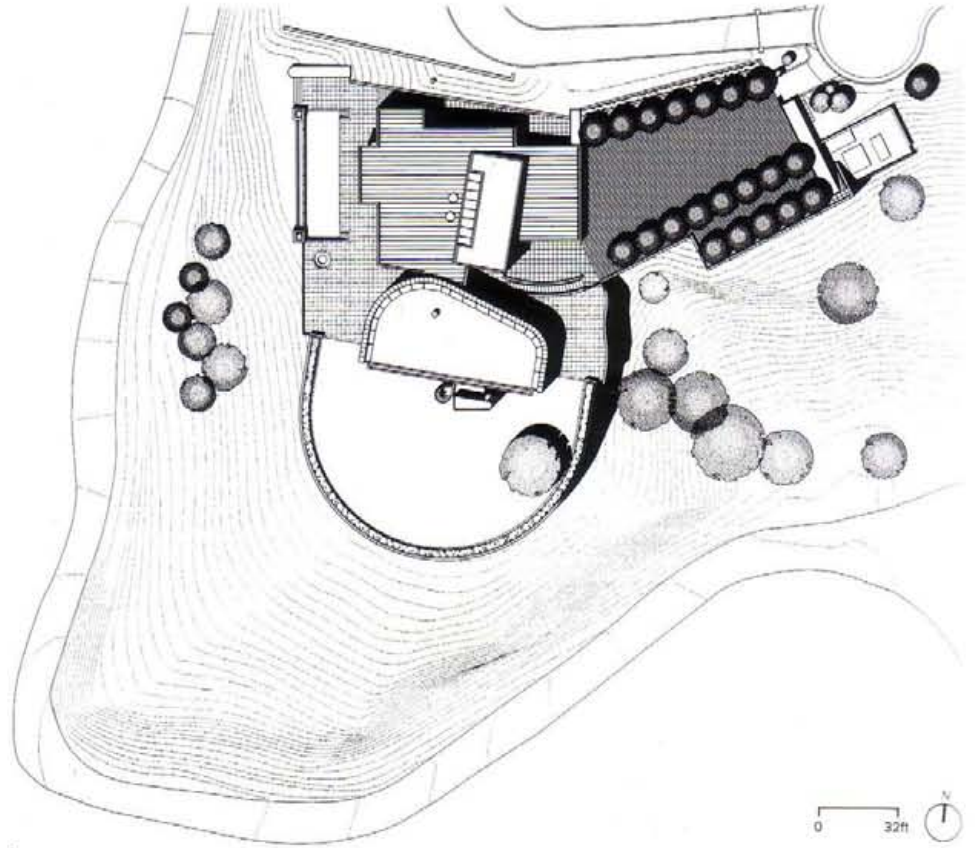

1



2

1 Site plan  
2 View of south facade  
Opposite:  
Detail of east terrace entrance





4



5

- 4 Front entry
- 5 Northwest view of pool terrace
- 6-9 Axonometric views
- 10 View of southeast corner looking north
- 11 Southwest pool terrace towards mountains

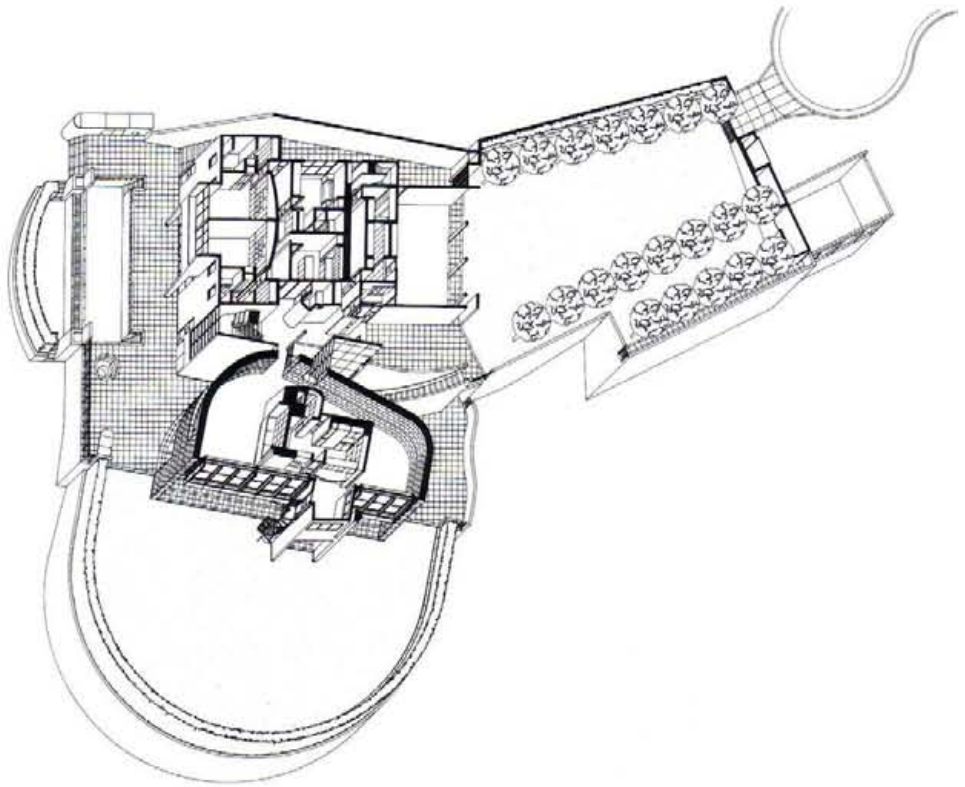

6

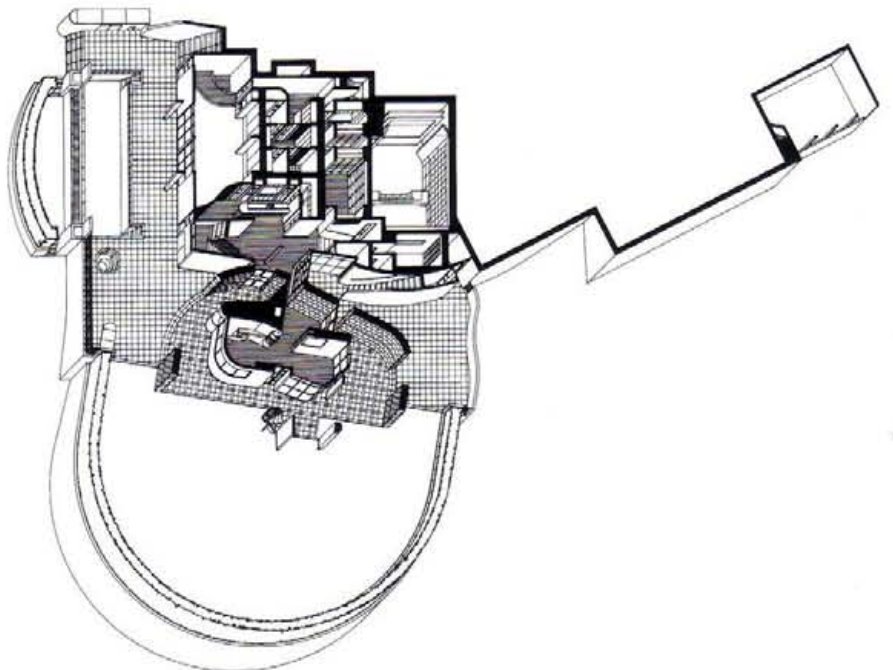

7



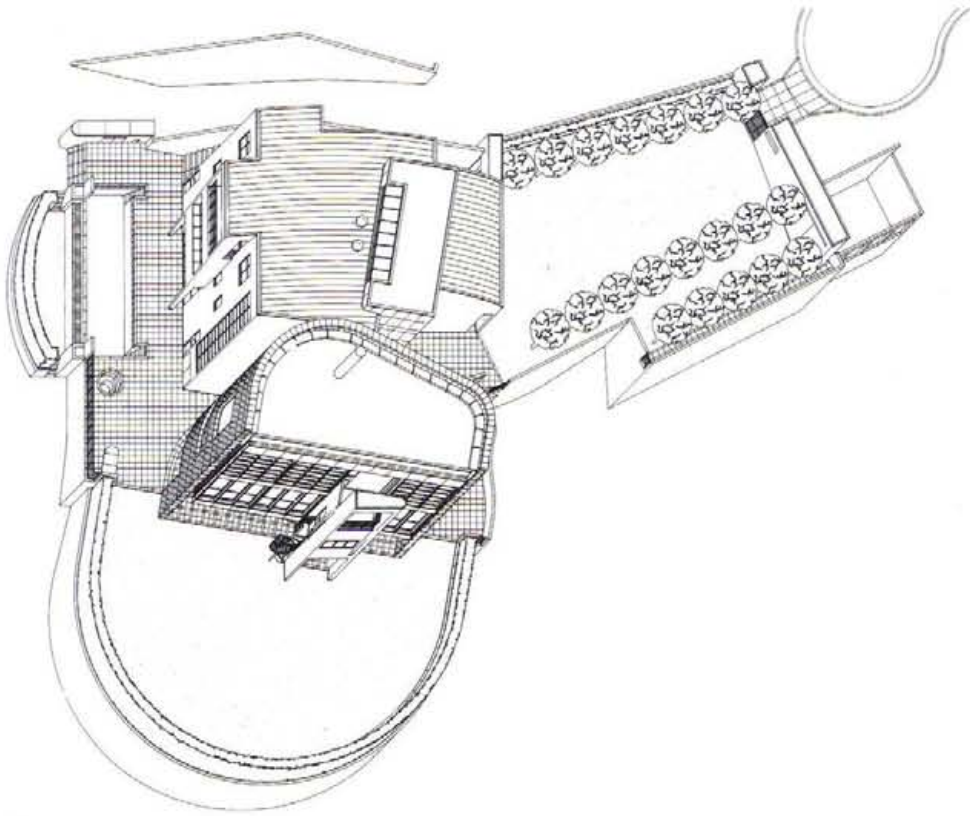

8

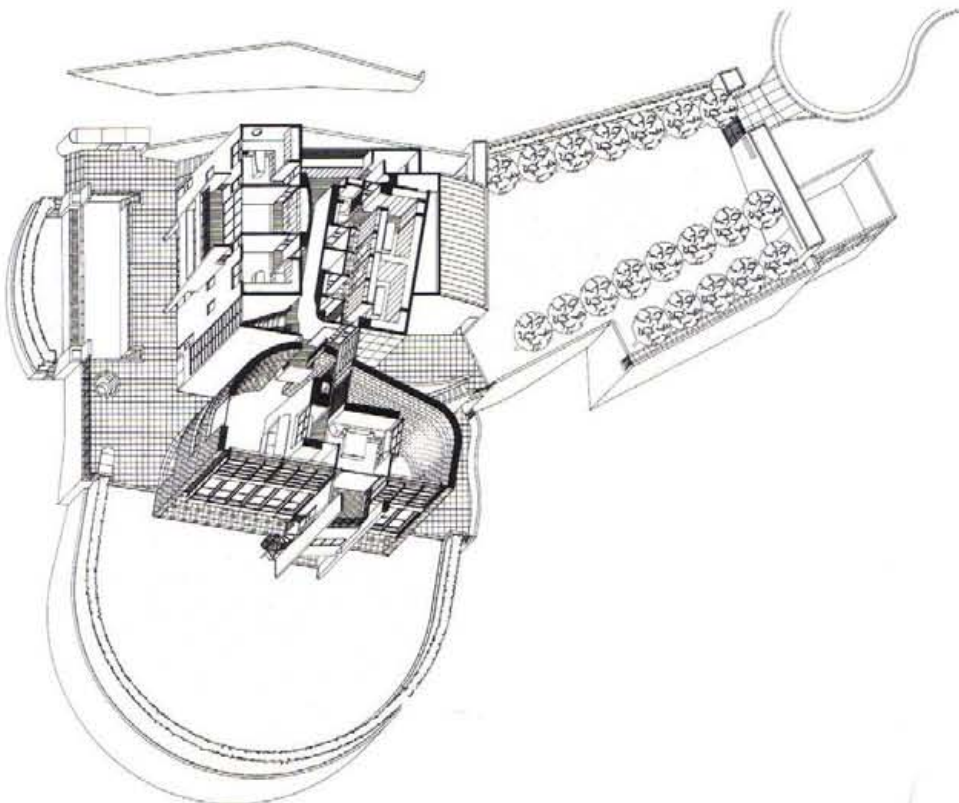

9



10

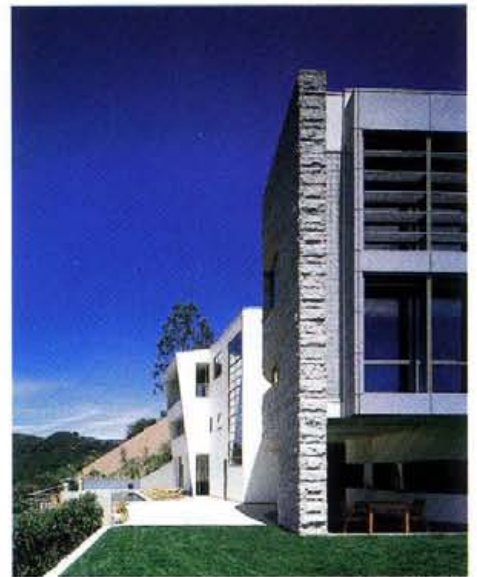

11

- 12 Library
- 13 Screening room
- 14 View of screening room entrance at lower level



12

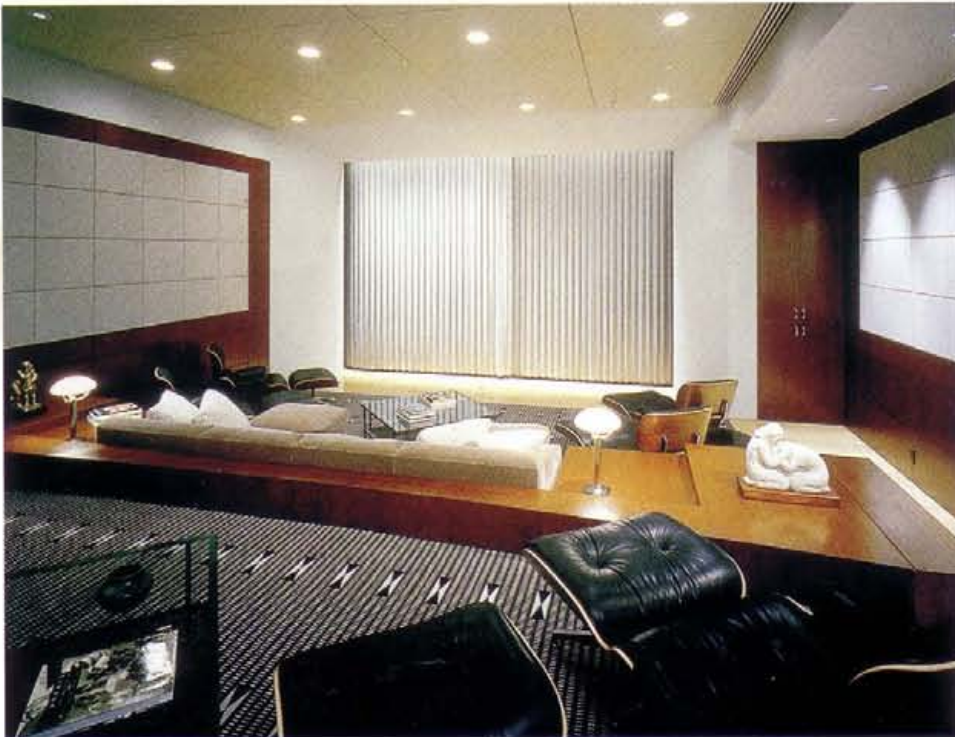

13



14





15



16



17



18

- 15 Living room
  - 16 Dining room
  - 17 Main stair from third floor: view towards mountains
  - 18 Master bedroom
- Opposite:  
Northwest view of pool terrace at dusk



# Institute for Human Performance, Rehabilitation and Biomedical Research, State University of New York at Syracuse

Design/Completion 1990/1999

Syracuse, New York

State University Construction Fund

200,000 square feet

Steel and concrete deck, brick, cast stone, aluminum panels, curtain wall

Plaster, tiles, special athletics surfaces

This facility for education, research, and patient care is a four-story structure accommodating a 19,000-square-foot gymnasium and track, a 75-foot-long medical research and rehabilitation swimming pool with a hydraulic floor, a full-service orthopedic treatment center, and 100 state-of-the-art flexible laboratory modules.

The building is divided into three parallel laboratory wings joined by two skylit atriums. The wings house research units grouped into laboratory modules and designed for maximum efficiency and flexibility in mechanical and utility configurations.

The two atriums bring controlled natural light into the main entrance and circulation space at ground level, the public gymnasium at the second level, and the laboratories at the third and fourth levels. They also establish the major public volumes by articulating the entrance and the gymnasium. Views from the laboratory windows across to the opposite wings and below to public spaces enhance a sense of community and create a collegiate atmosphere.

The design, which evolved from precise and extensive technical criteria, provides climate-controlled spaces for multiple medical and recreational functions. Public and private domains are expressed by manipulation of the light and the solid-void relationships.

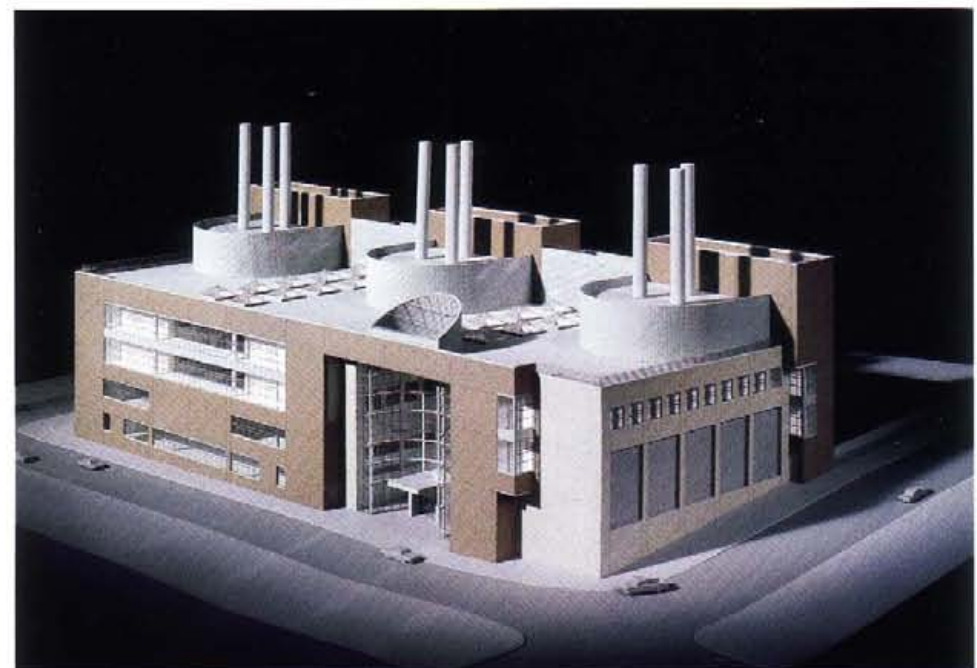
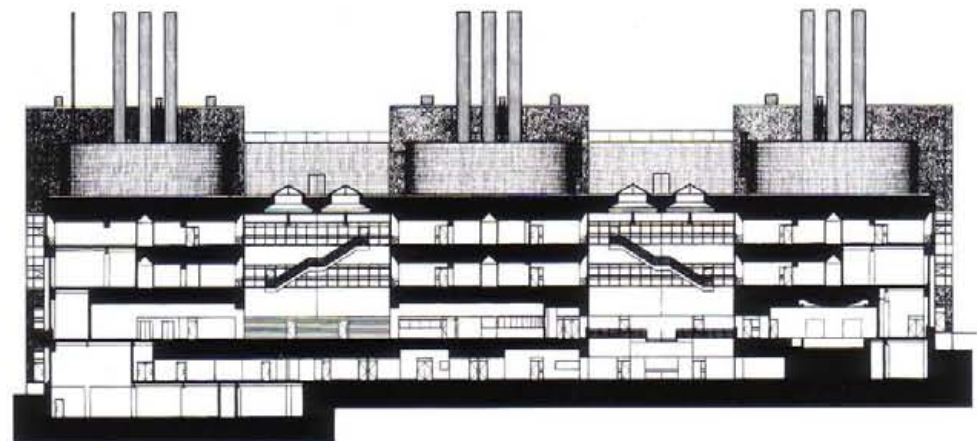
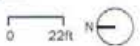

3

4

- 1 First floor plan
- 2 Longitudinal section
- 3 Detail of entrance plaza
- 4 Aerial view of model looking southeast
- 5 Model view from southeast
- 6 Model view from northeast



5



6

## PaceWildenstein Gallery

Design/Completion 1994/1995

Beverly Hills, California

PaceWildenstein

10,000 square feet

Black granite, stainless steel, ardex concrete and carpet floors,  
Formica cabinetwork, painted plaster walls

This new gallery is housed in three separate buildings at the intersection of Wilshire Boulevard and Rodeo Drive.

The entrance opening, situated in the first building on a narrow pedestrian alley off Rodeo Drive, was enlarged to reveal a street presence.

The reception area mediates a change in level between the entrance and the ground floor exhibition space in the second building. The walls of the 17-foot-high volume are rotated from the column grid to maximize uninterrupted wall surfaces. A wide stair leads to a mezzanine overlooking the main floor, lit by six new windows punched into the facade.

A stair from the mezzanine leads to another gallery on the second floor of the third building. A grid of existing columns and beams is used to modulate the long space into a series of more intimate rooms suitable for exhibiting smaller work, such as drawings and photography.

Along the perimeter of the building, a floating wall is brought forward by a single row of glass blocks at either end, and stops at the underside of the beams. Lit from behind, the wall controls natural light from the five existing windows and creates an interior hanging surface and a street facade for the gallery.

Behind and beyond the exhibition area are private offices and viewing rooms, accessible from the viewing gallery and from a separate elevator lobby.



- 1 Second level private reception and waiting area
- 2 Front entrance to gallery off Rodeo Drive
- 3 Front reception desk
- 4 View of ground floor gallery from mezzanine
- 5 Ground floor sculpture and painting gallery





3

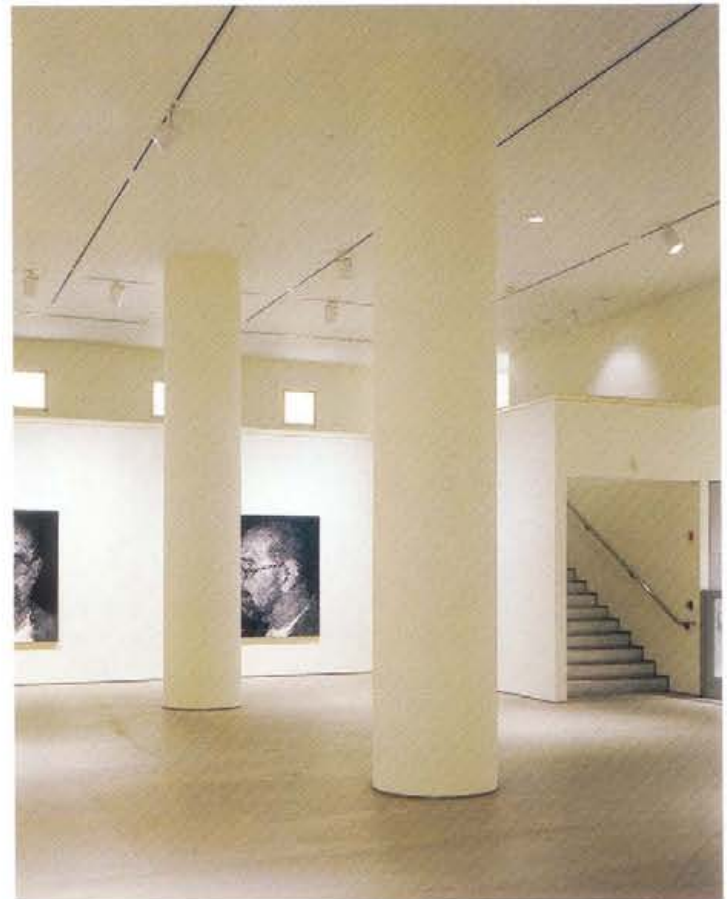

5



4

- 6 Second level plan
- 7 Ground level plan
- 8 Director's office
- 9 Entrance to picture gallery from private reception area
- 10 Private reception desk and waiting area
- 11 Second floor drawing and picture gallery

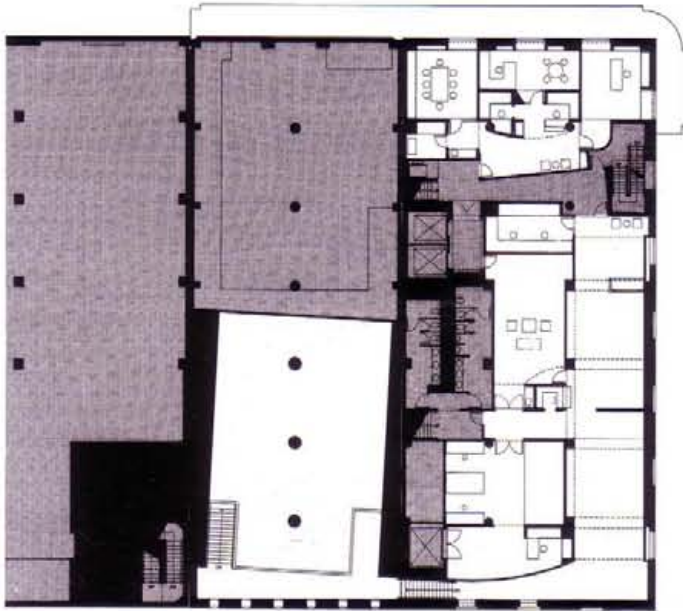

6



8

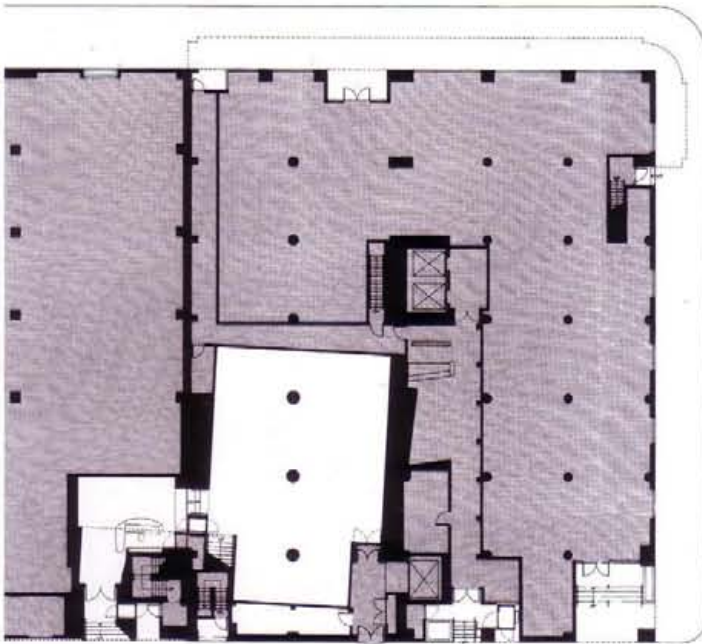

7

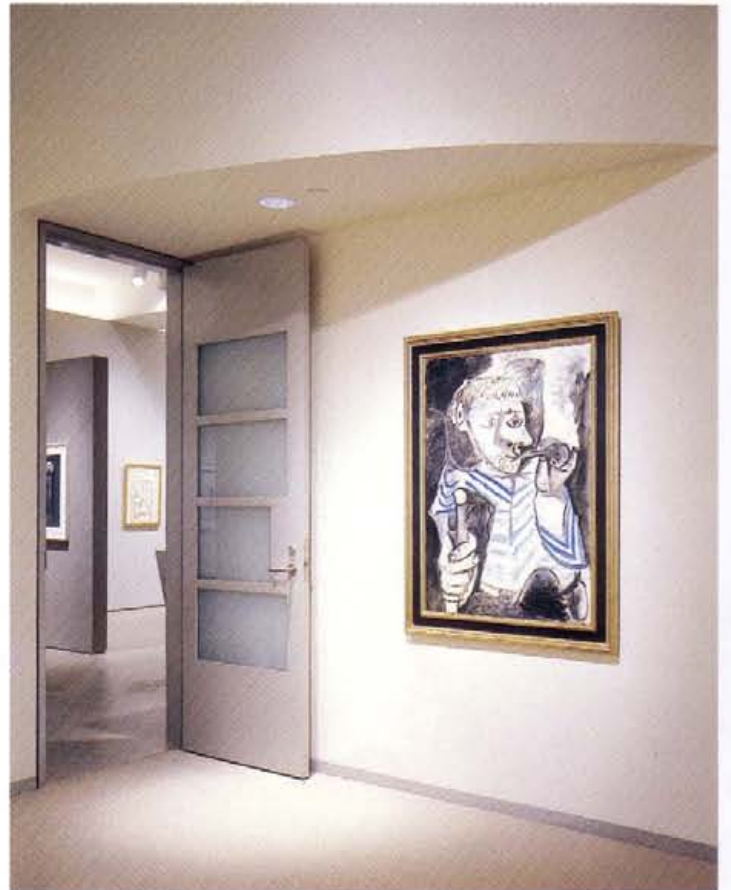

9



10



11

# University Technology and Learning Complex, Lawrence Technological University

Design/Completion 1997/1999

Southfield, Michigan

120,000 square feet

Painted aluminum panels, clear and frosted insulating glass, stucco,  
painted steel standing seam roofs

The new building is an educational facility for the study of architecture, engineering, interior design, and object design. The program includes state-of-the-art electronic, computer, and learning facilities; expanded studios and laboratories; galleries and lecture rooms; an office of the future; a resource center with a 15,000-volume library; and classrooms, conference rooms, and office spaces. The complex will renovate and expand the current Architecture Building and provide an enclosed link to the existing Engineering Building.

Vehicular traffic will be redirected around the campus perimeter; landscape design will redefine the main quadrangle, adding a dramatic new gateway to the campus from the Ten Mile Road entrance.

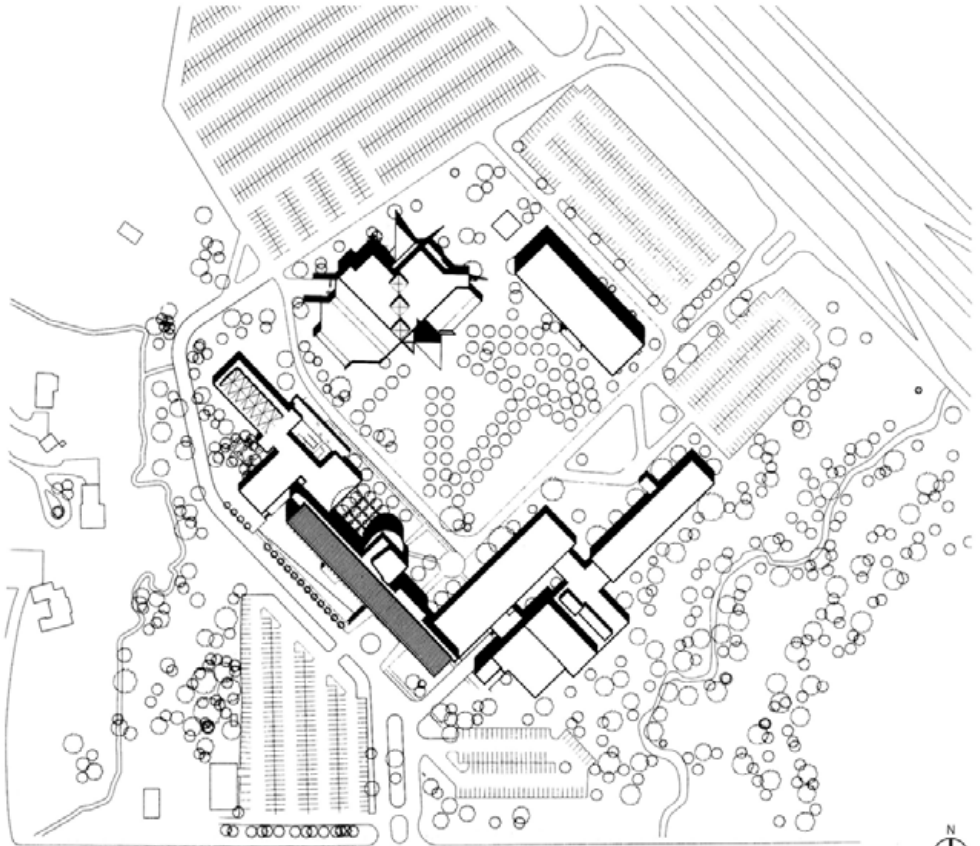

1

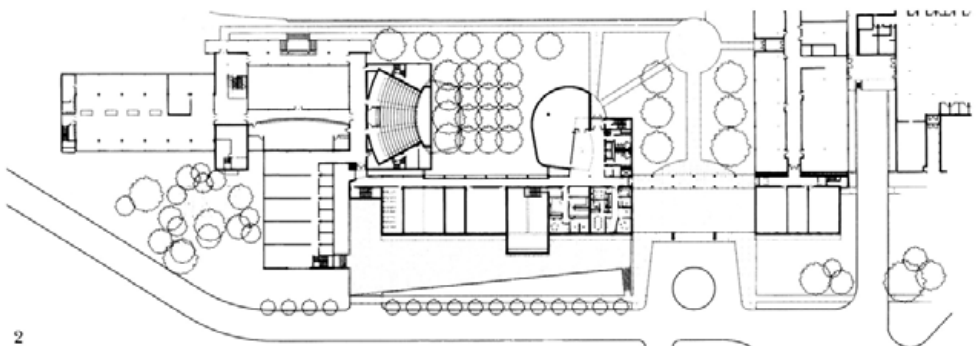

2

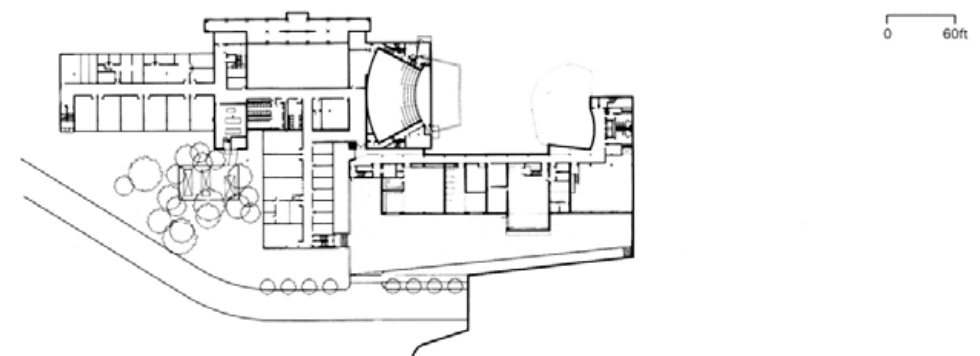

3

- 1 Site plan
- 2 Second floor plan
- 3 First floor plan
- 4 North elevation
- 5 South elevation
- 6 South elevation looking west
- 7 Section
- 8 North elevation looking west
- 9 North elevation looking east

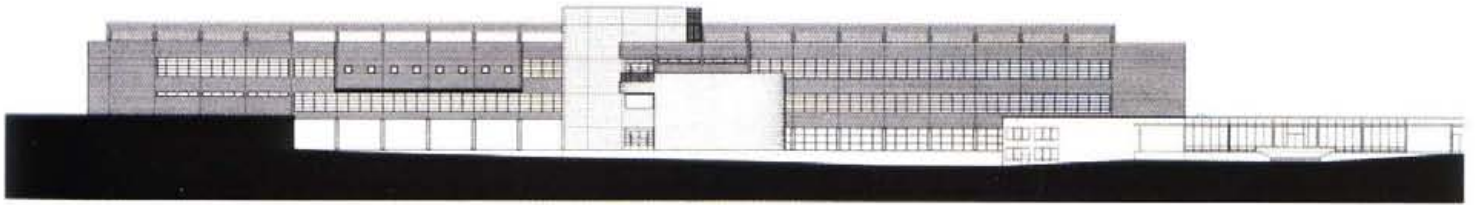

4

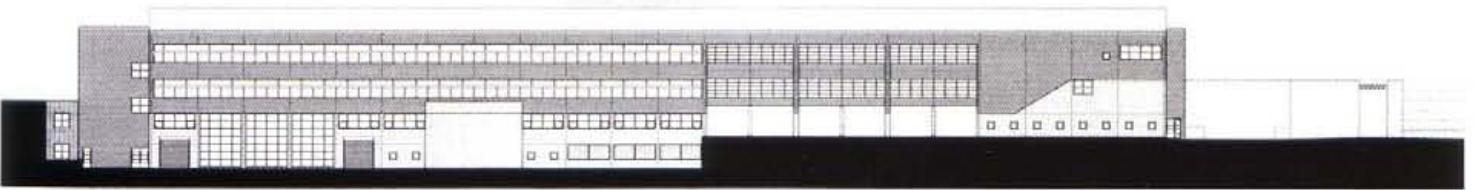

5

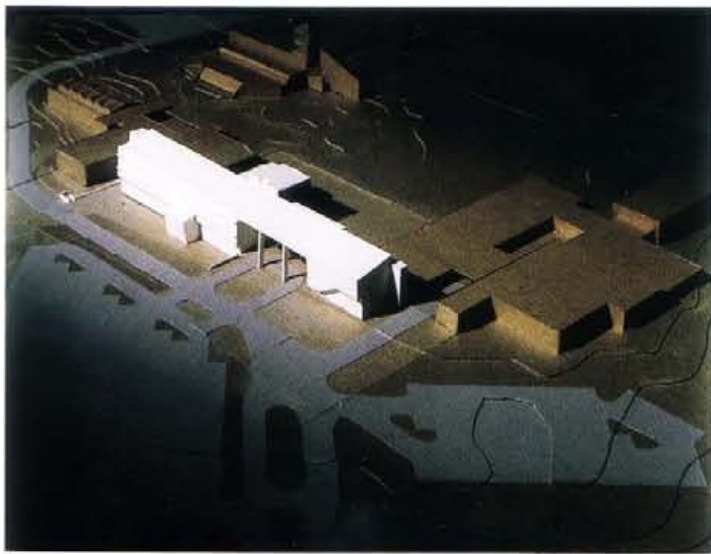

6

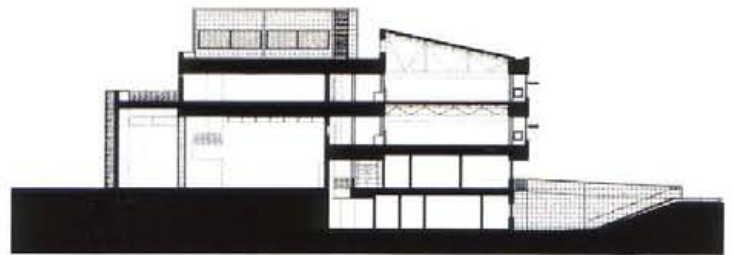

7

0 40ft



8

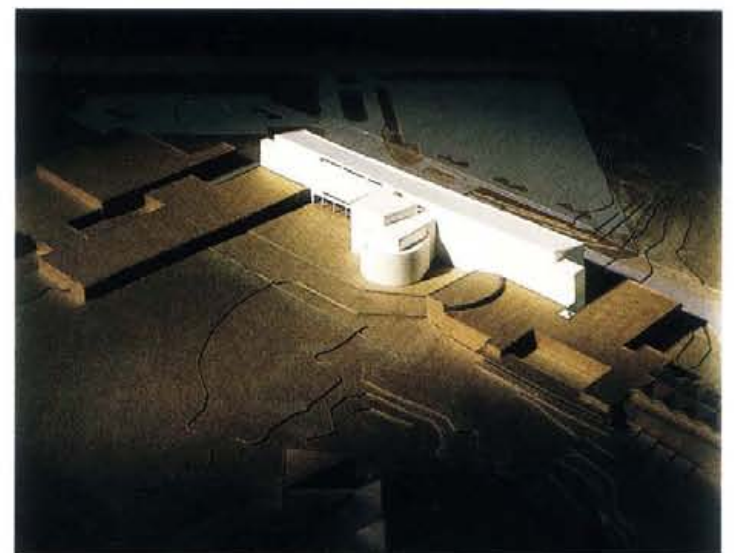

9

**Baker Library, Graduate School of Business Administration, Harvard University**

Design/Completion 1996/2001  
 Cambridge, Massachusetts  
 Harvard University  
 160,000 square feet  
 Brick, stone, steel

Baker Library was designed by McKim, Mead & White Architects in 1925 and is situated in the heart of the Harvard Business School campus. The renovation and addition address the complex integration of the traditional study library, the modern electronic library, and a dynamic new vision of a globally linked teaching and meeting facility. The design will create a strong new visual image that remains contextually sensitive to the site while offering a new main south entry quad.

The renovation includes the main Reading Room, the Aldrich Reading Room and the Rare Books Library. New facilities include four multi-use gathering spaces, book stacks, a computer commons and cafe, conference/meeting rooms, library staff offices, and a multimedia television studio.

The dominant image of the new south facade is the rotunda, the building's primary entry, meeting, and circulation space. This five-story-high volume is defined by concentric stairs and balconies at each level. The rotunda and the three other gathering spaces—the existing double-height north lobby and two two-story balconied volumes—afford maximum flexibility.

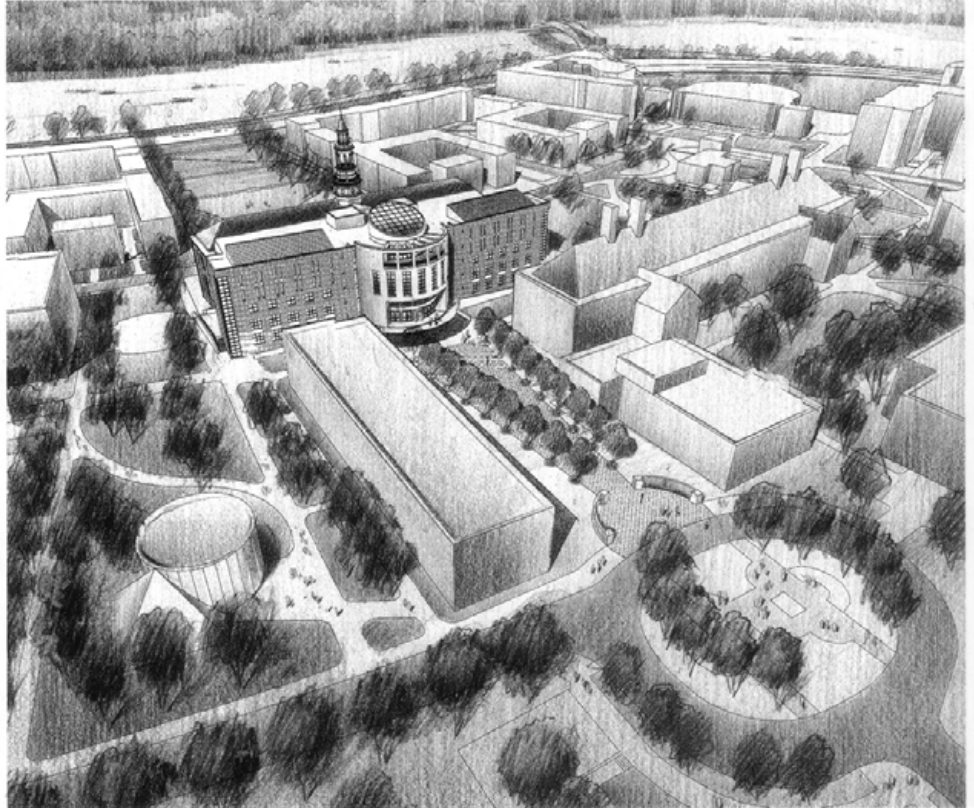

- 1 Aerial view of new south entry quadrangle
- 2 View from new south entry quadrangle
- 3 View inside rotunda looking towards new south entry quadrangle
- 4 View inside rotunda looking north
- 5 View into rotunda from balcony
- 6 View into multi-use gathering space from meeting room gallery
- 7 View into multimedia television studio
- 8 Sectional view of multimedia television studio

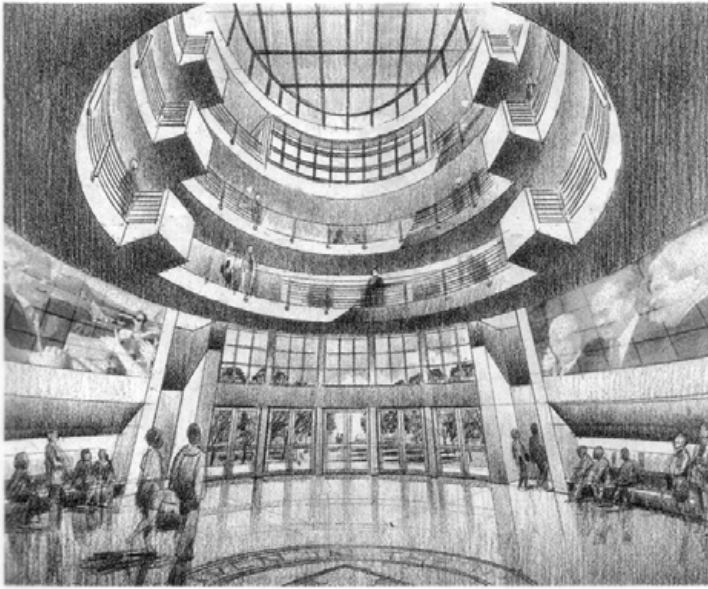

3

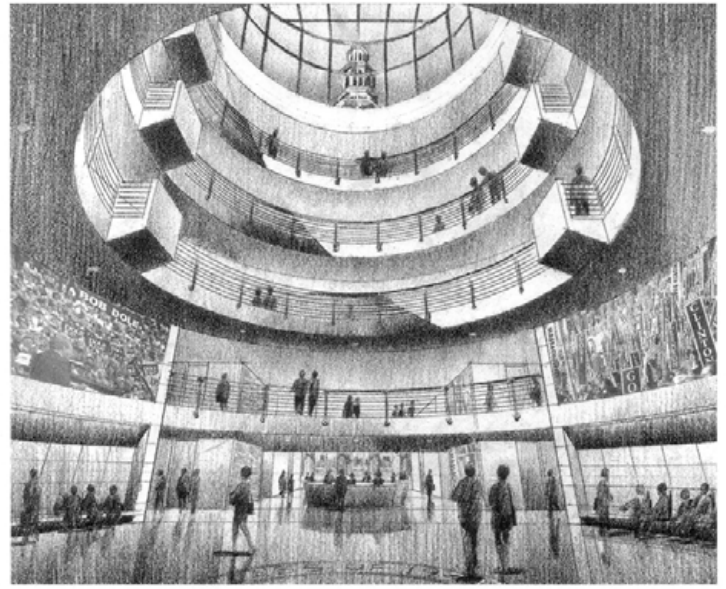

4

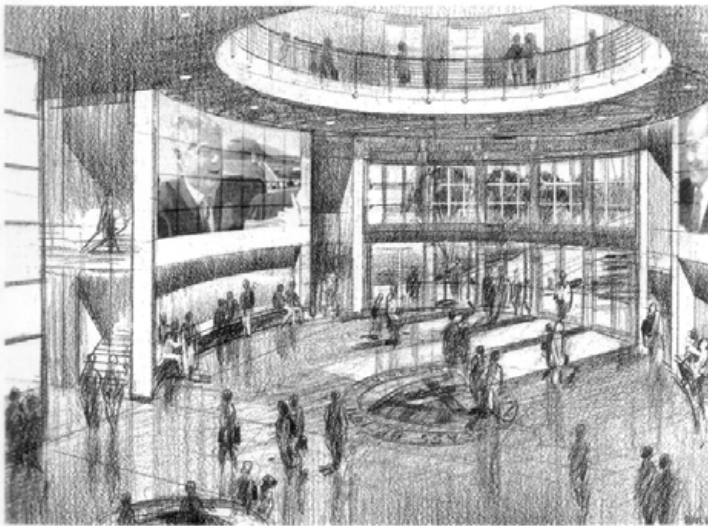

5

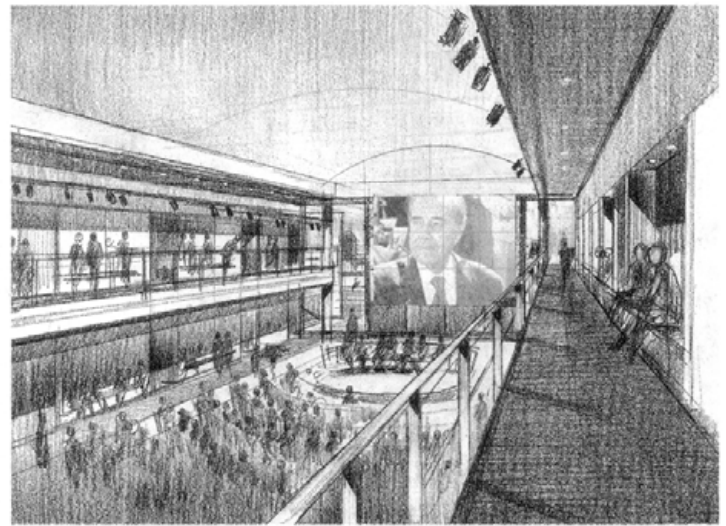

6

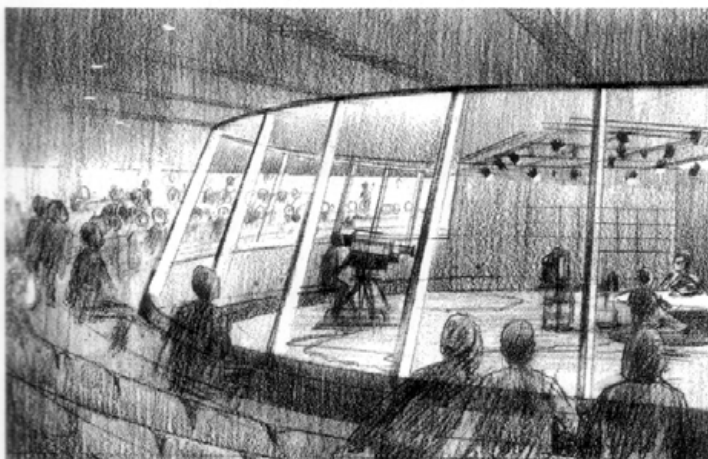

7

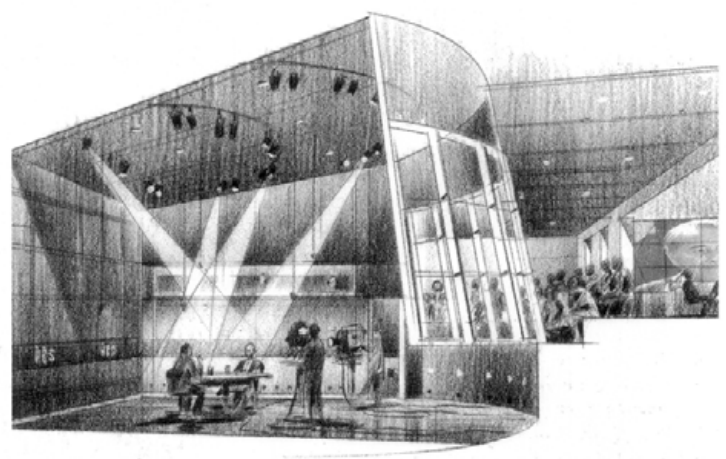

8