

Architecture and Human Senses

Pre-School in Alexandria Old Town, Virginia

by Björn Steudte

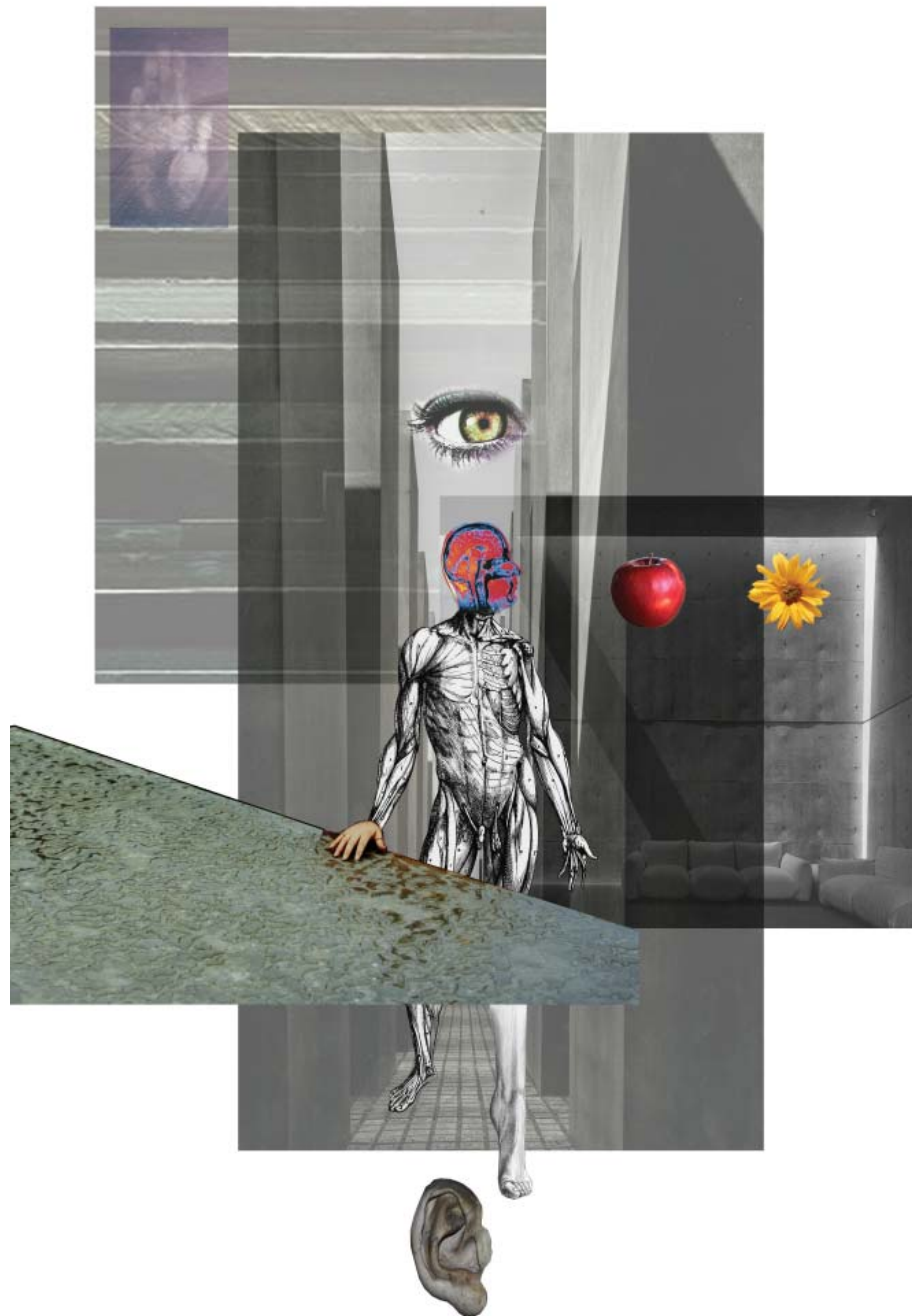

Architecture and Human Senses

Pre-School in Alexandria Old Town, Virginia

by Björn Steudte

Thesis submitted to the Faculty of Virginia Polytechnic Institute and State University in partial fulfillment of the requirements for the degree of

Master of Architecture

May 23, 2007, Alexandria, Virginia

Thesis Committee: Jaan Holt, Chair
Susan C. Piedmont-Palladino, Committee Member
Paul Emmons, Committee Member

Keywords: space, human senses, material, parochial realm, education, perception, feeling, sound, light, taste

Copyright by Björn Steudte

Architecture and Human Senses - Pre-School in Alexandria Old Town, Virginia

by Björn Steudte

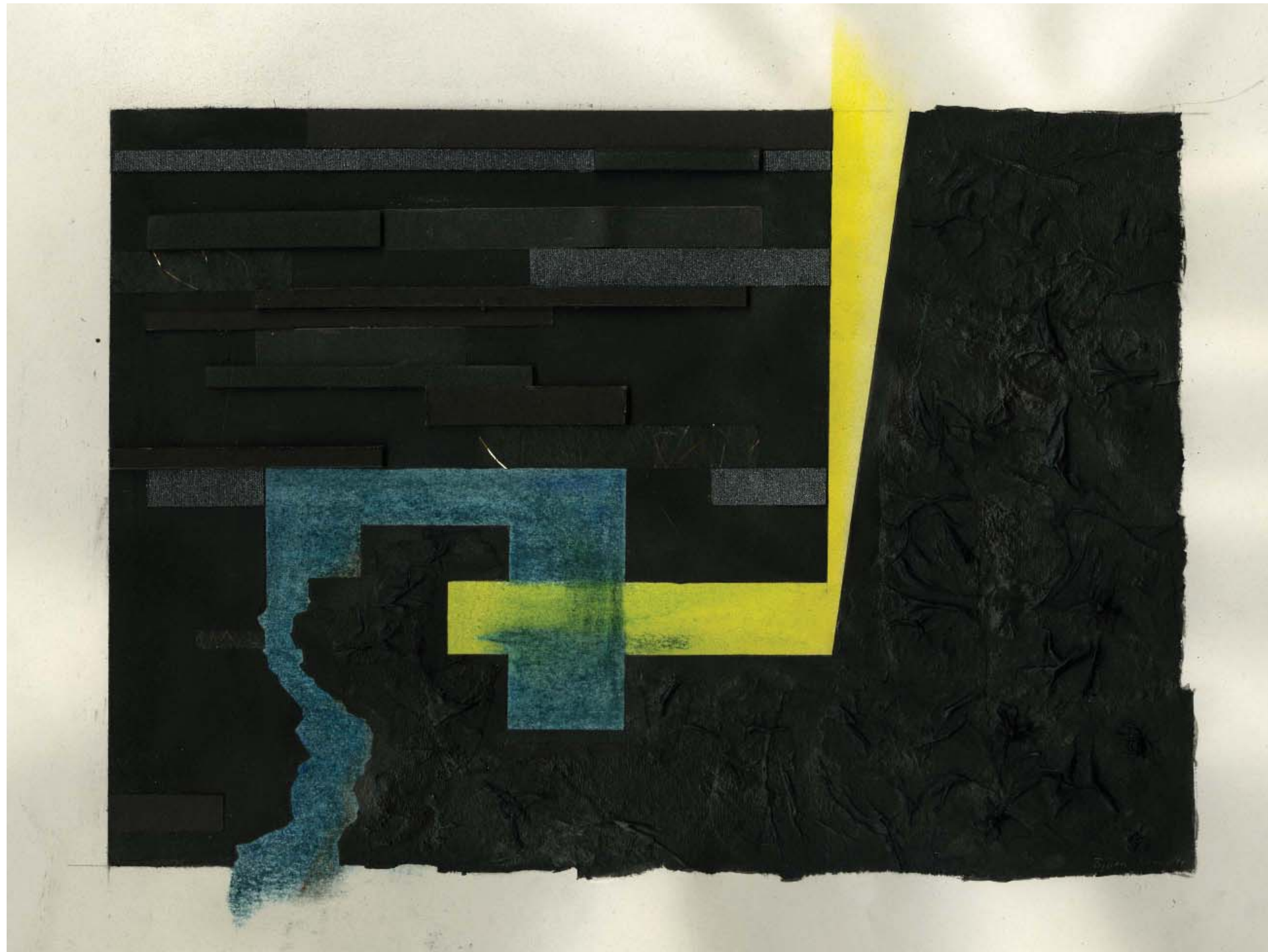

Abstract

Throughout my years of architecture education I have become more and more aware that we are connected with architecture from the very first moments of our life. Architecture, an important part of our environment, affects our experiences, feelings, memories, and ultimately the decisions we make. To exploring the connection between architecture and the human experience was the intention for my thesis. Whether positive or negative, everything created or done by man has an affect on his environment. Some people are more aware of their architectural environment some are less but at the end we all life with it and have at least an unconscious impression of it. Based on these impressions and the consciously experienced details of our environment, of events we have feelings and make judgments and decisions. The nice dinner on a Friday night which makes you feel comfortable and good, it is a result of the whole environment of the place where you have dinner. Not only the room temperature, your company, your table neighbors, the restaurant staff, the expectations of the coming weekend but more important the dimensions of the space that make it feel grand or intimate, the way sound sticks to the walls or bounces off them giving life to the space, or the way a single beam of light can show you the beauty of colors and materials.

Acknowledgments

THANKS

to

my parents Gudrun and Hans-Jürgen, my sister Sirka, her husband Ronald, my niece Lara, my nephew Arvid, my grandparents and Lori for all their support, their ideas and their encouragement

to

the DAAD (German Academic Exchange Service - <http://daad.org>)
who supported me with information and a scholarship for my entire master program

to

my thesis committee Susan Piedmont-Palladino, Jaan Holt, Dr. Paul Emmons, Ph.D.
and all faculty members of the Washington-Alexandria-Architecture-Concortium, especially Ulrike Altenmüller,
for all their support, advice and dedication

and to wonderful friends and supporters

Benjamin Butz, Magdalena Egües, Carolina Dayer, Kate Drury, Florencia Conalbi, Paola Meretti, Elena Parodi, George Makrinos, John Foley,
Huong Nguyen, Joanne Trumbo, Greg Porter, Cheryl Moy, Grzegorz Wartak, Dena Kennett, Donkeon Kim and his wife,

Ramona Sonntag, Agustin Merino, Hendrik Klein, Andro Mänd, Gustavo De Jong, Ignacio Guisasola, Adrian Oggero, Werner Nerlich, Valentin Diez,
Nestor Cerami, Tania Saracho Rosales, Petra Benzulla, Susanne Niemsch, YanYan Li, Juan Pablo Scaraffia, Elisa Uano, Yves Six, Christine Büttner-
Gräffenhain, Daniel Büttner, Nashwell Hays, Adam Perris, Carplyn Parris, Andro Mänd, Brian Bohlen, Cecilia de la Vega, Santiago Mosso, Kelvin
Webster, Laureen Schlather, Laura Croce, Richard Gallagher, Alejandro Santos, Soledad Pellegrini, Timo Lorenzen-Schmidt, Leao Salom,

and to

all other friends at the WAAC, the Baushaus University Weimar and back at home

Table of Contents

Abstract	ii
Acknowledgements	iii
Table of Contents	iv
Introduction	10
First Thoughts	14
Urban Context	20
Site Analysis	22
Building Concept	26
Building Design	34
Building Structure	38
Light Concept	40
Interior	46
The Gardens	52
The Roof Terrace	54
Final Project: Pre-School in Old Town Alexandria	58
Conclusion	76
References	78
Vita	79

Introduction

At the beginning of my thesis I focused mostly on different treatises in the fields of architecture and human senses. To keep the connection to the design work I joined in Fall 2005 the “American Front Door” Competition.

My general thesis interest was in architecture that is able to guide people simply by its existence; guiding with geometries and materiality – no signs, no texts, and no explanations. The Design task was to develop an entry experience accessible by the disabled/handicapped; for a residence with a floor level 2 feet above street level. The intention of the design was to use a typical space *defining* element to *describe* the contrast between the public street and the private home. The WALL, as a solid element, expresses the *separation* between active public spaces and protected private spaces while as a *spacial* element it becomes the bridge that connects two separated environments.

The window in the wall frames the outside world and emphasizes the elevated garden as an additional room of the existing house.

The far end is occupied by bamboo trees which function as a natural barrier which shields views into the garden.

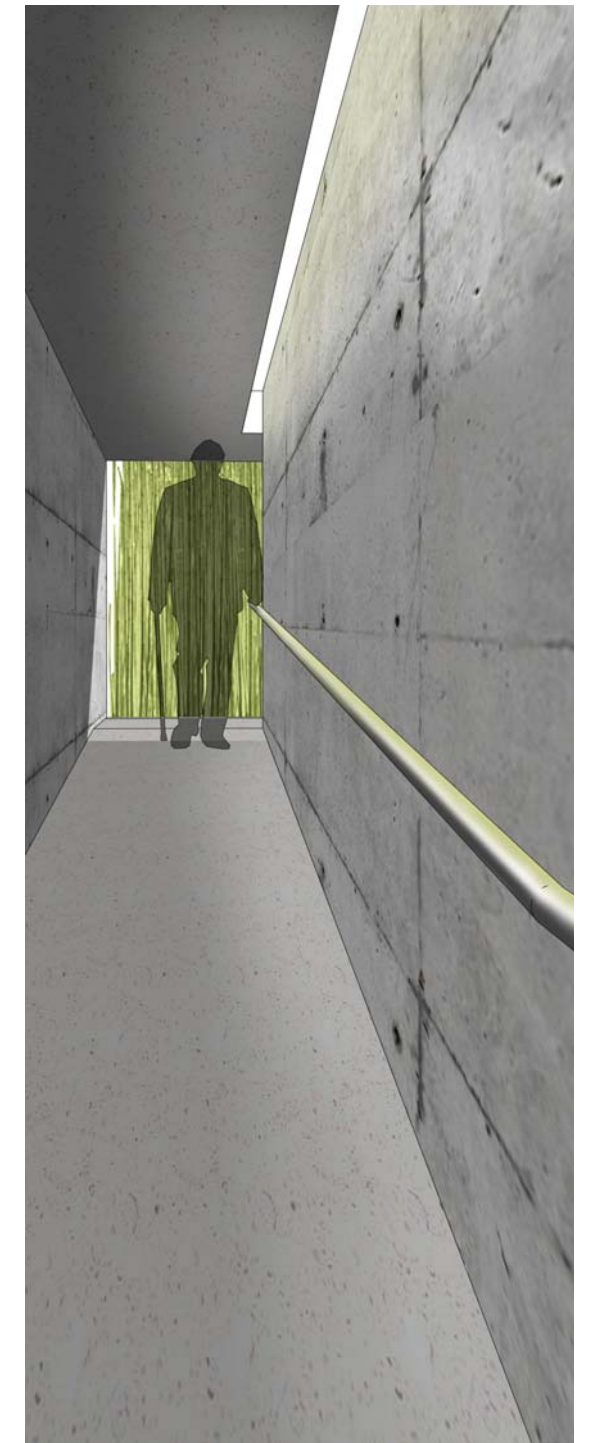

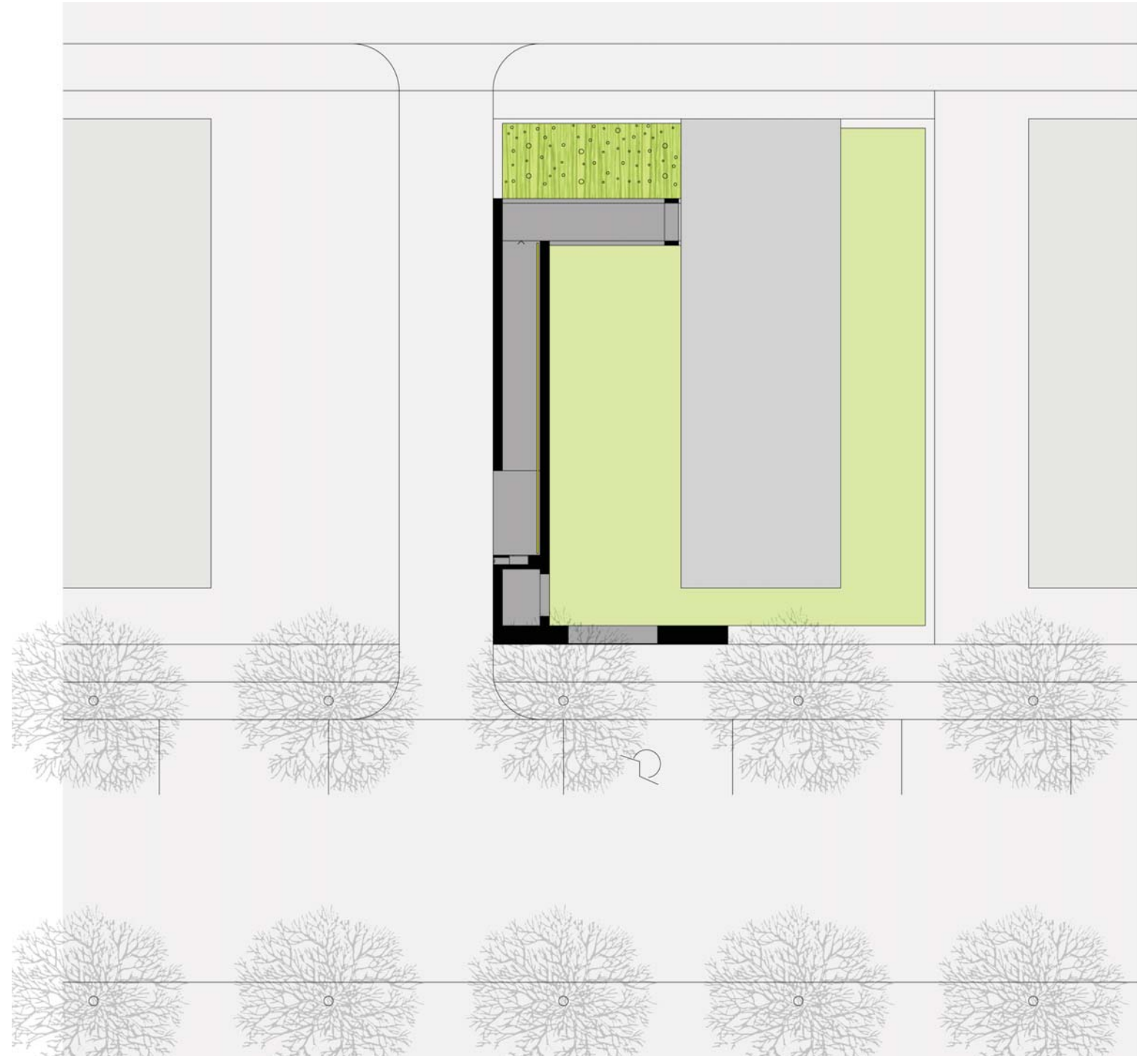
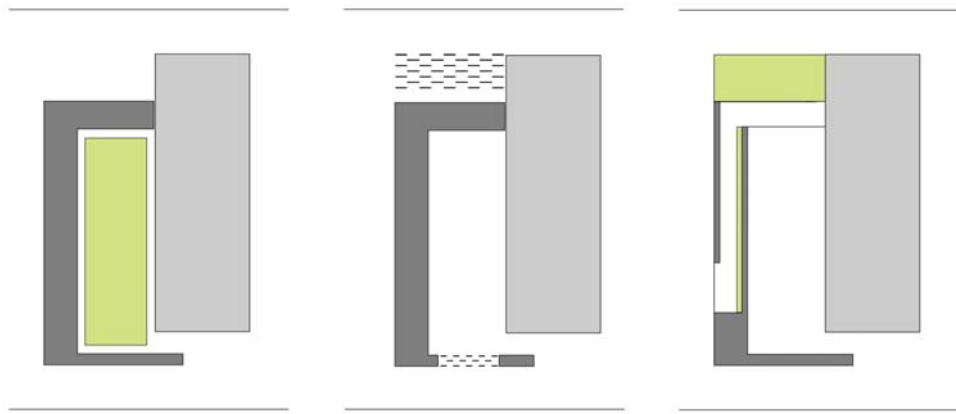

To enter the private areas you have to walk through the WALL.
The path in the wall contains a ramp which connects the street level with the house level. Everyone who goes through the wall is guided by the different elements – a light gap in the ceiling, and a reflecting metal handrail reveal the path as filtered light through the bamboo trees attracts one forward. The intention was to use the ramp and the wall as architectural elements without exaggerating their functional purposes.

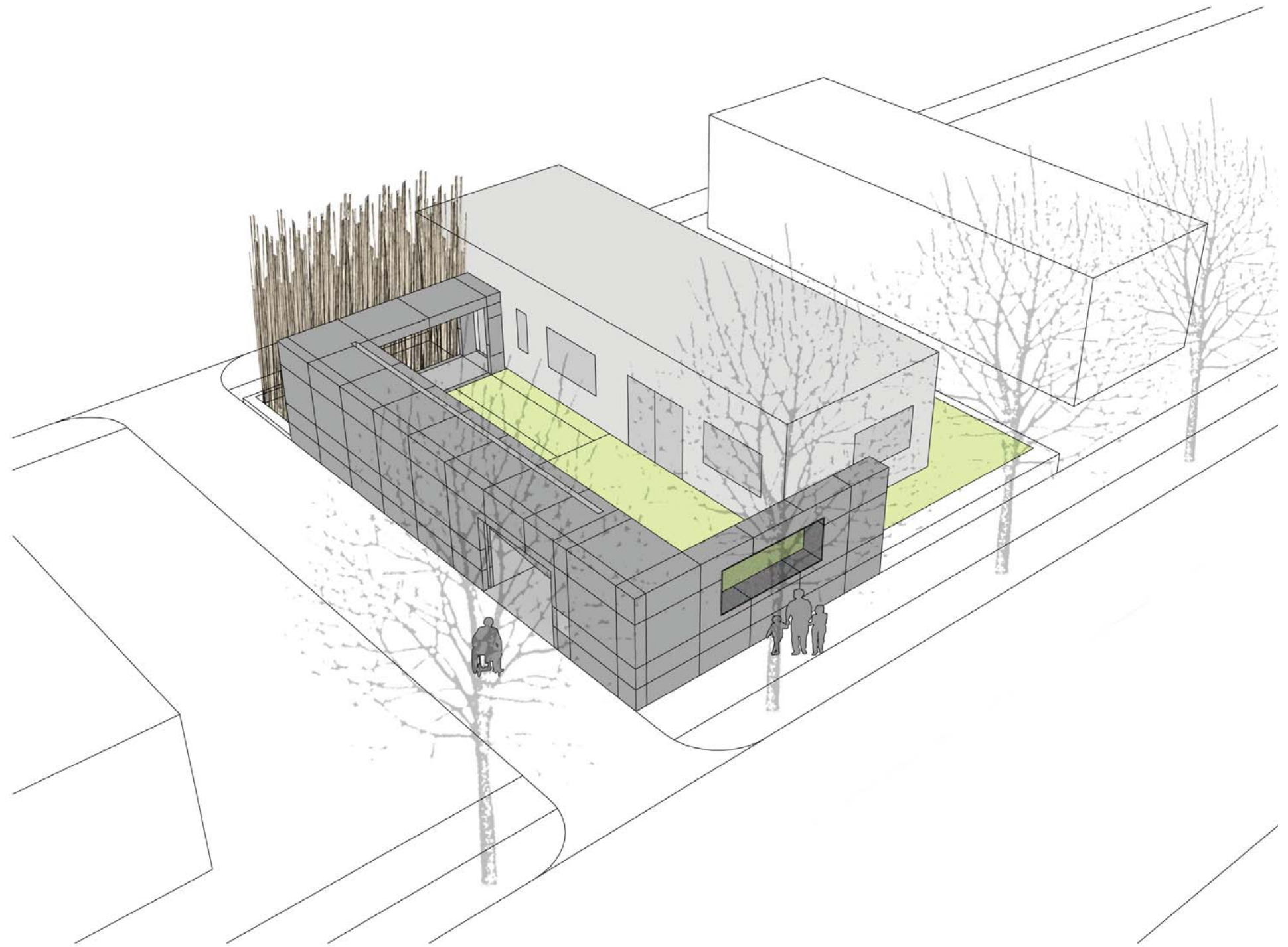

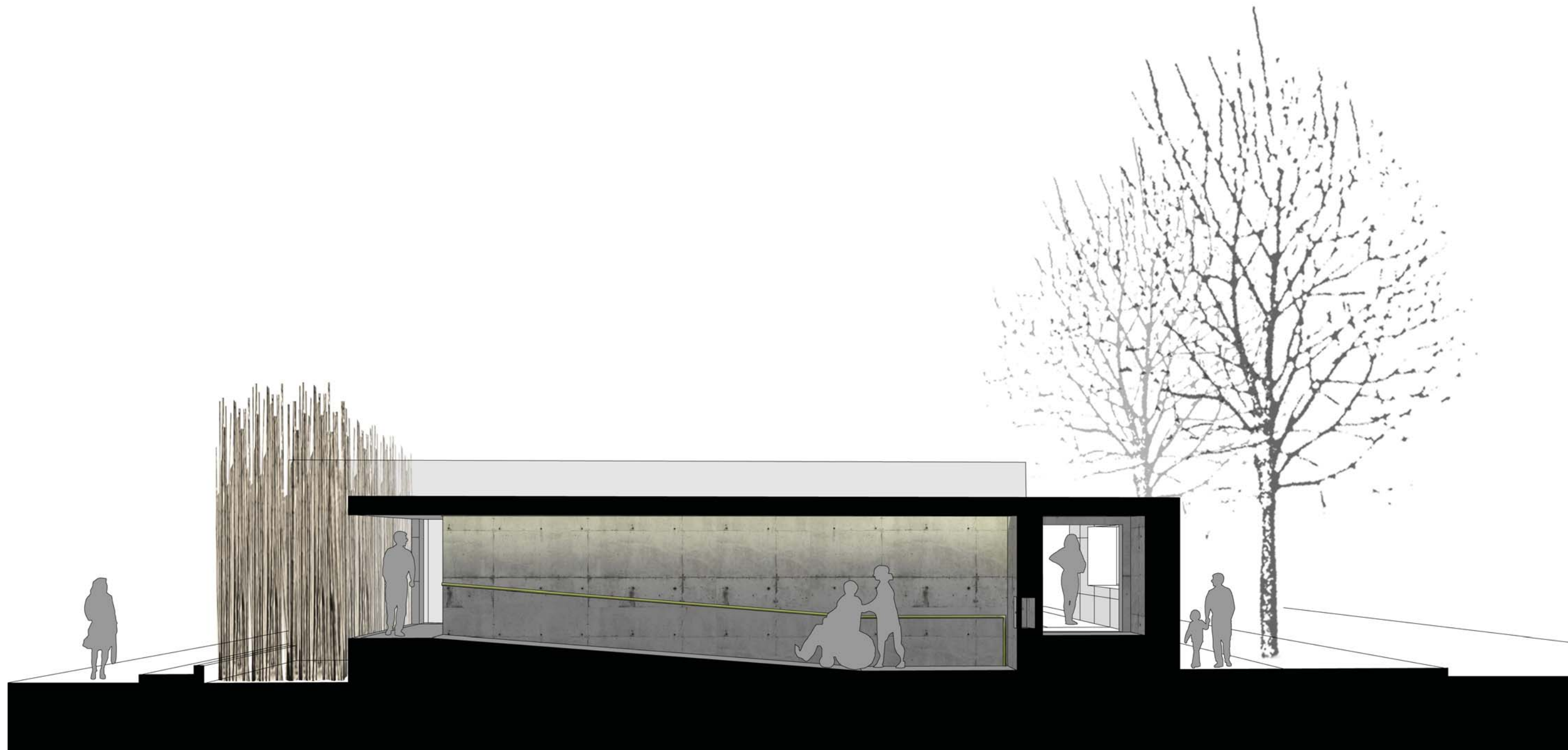

First Thoughts

Based on my competition project and my previous research I decided to focus my theoretical thesis work on the field of architecture and human senses, and because humans are aware of their environment from the first moments of their life. I chose to prove my readings and my theoretical ideas in the design of a pre-school in Alexandria Old Town. The pre-school operates from 6 am to 6 pm; Monday - Friday, similar to a day-care facility with the children ranging from two to six years of age.



The built environment, as interpreted through the eyes of a four year old child; *Image drawn by Lara Steudte, 2006*

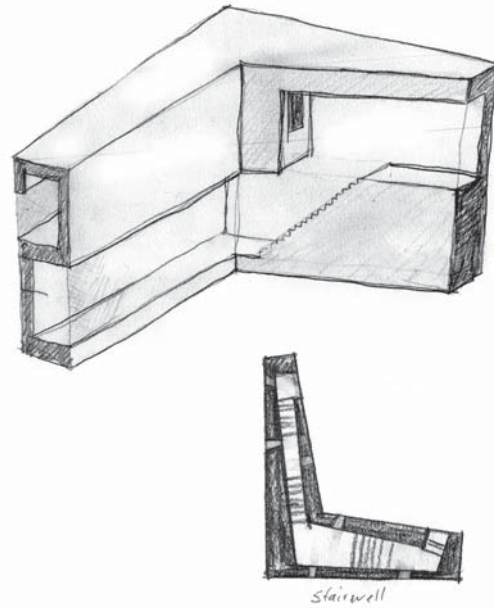
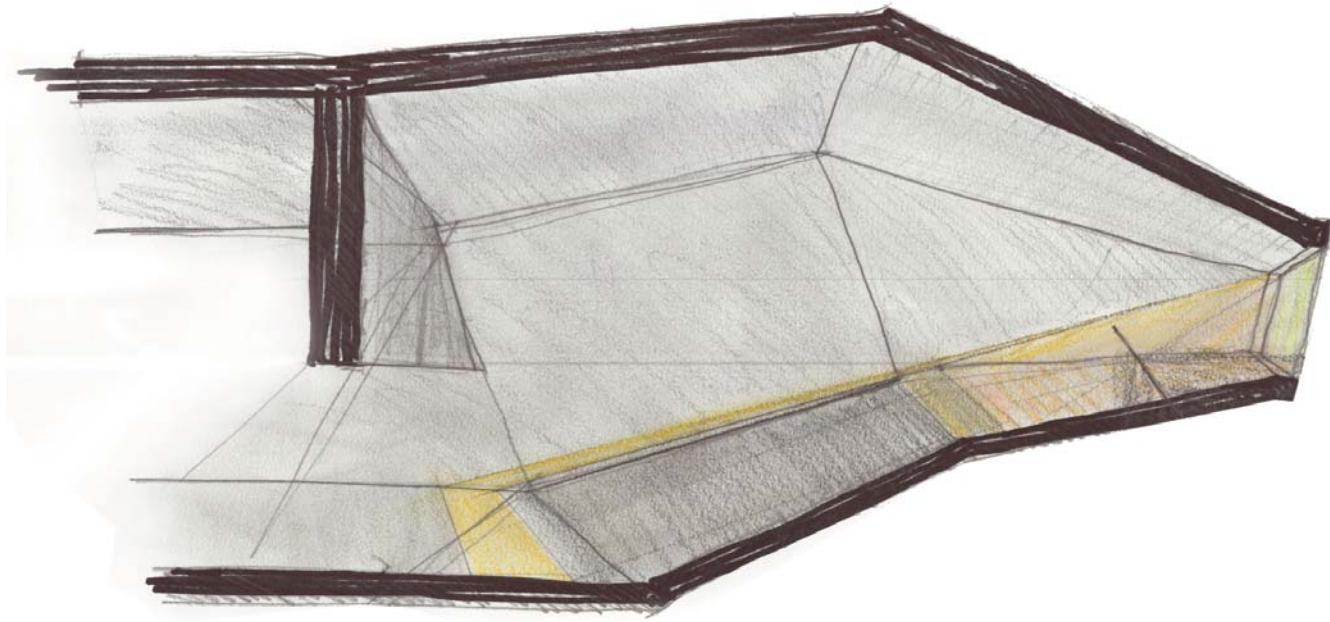

Initially, my intention was to find architectural elements such as the stair, the window, and the wall and combine them with elements familiar to children at play - such as the cave, the tower, the tree house.

The push/pull of objects and space creates tactile and unexpected spaces that appear new from every angle.

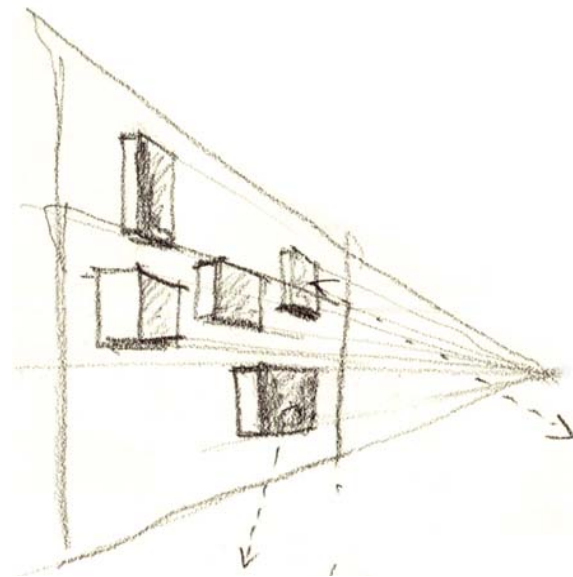
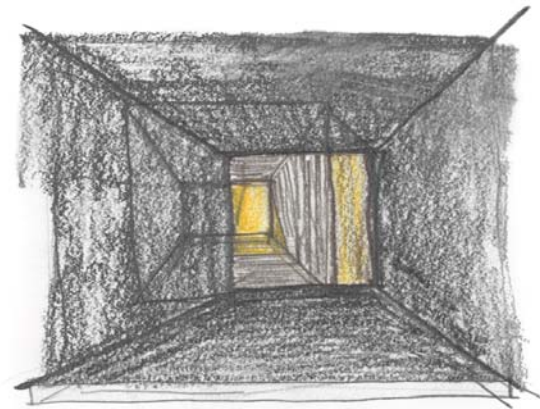
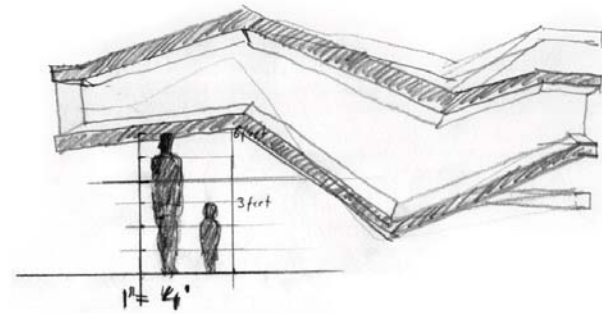

Scale studies illustrate how children and adults experience the same world differently. The differences can be exploited for functional reasons, (e.g. door handles at a child's height) and to emphasise the character of the building, e.g. floor level windows only appreciated by lying on the ground, child-size gaps and passage ways.

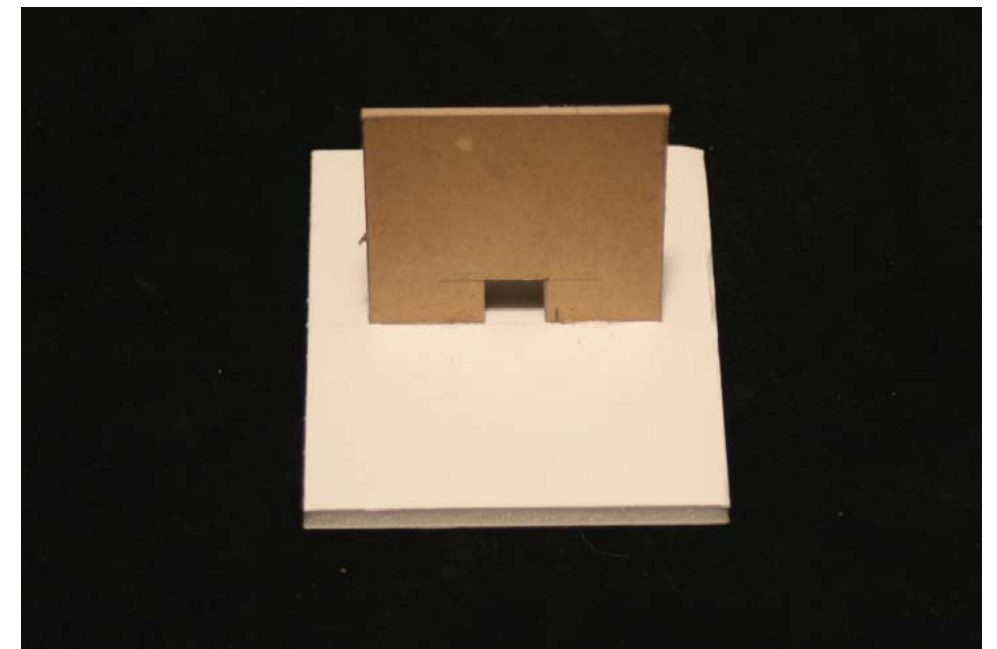
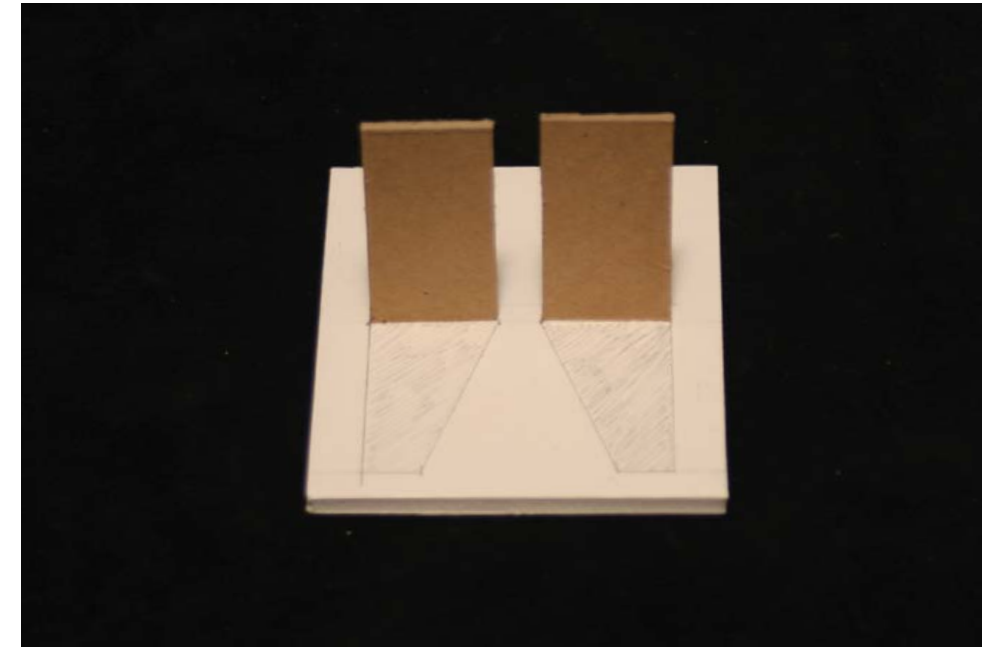
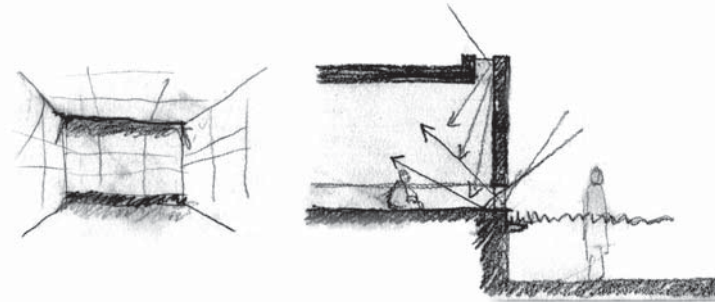
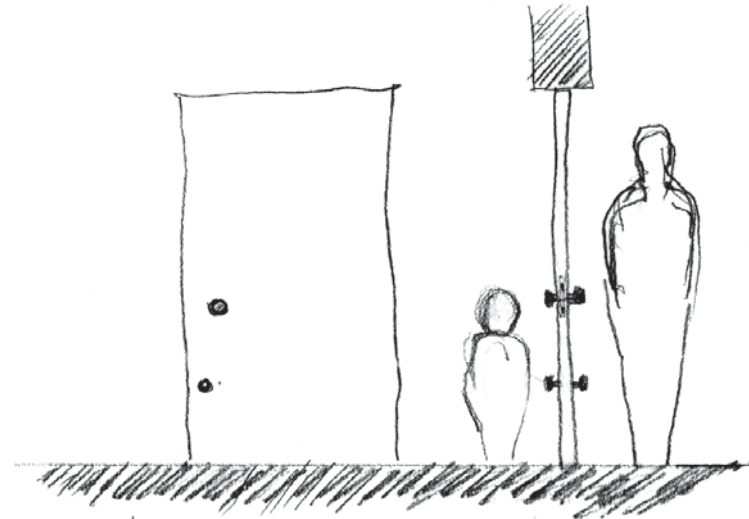
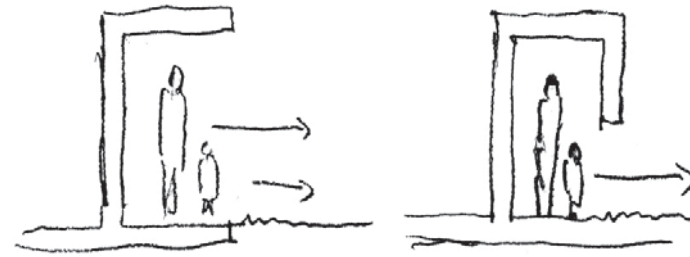

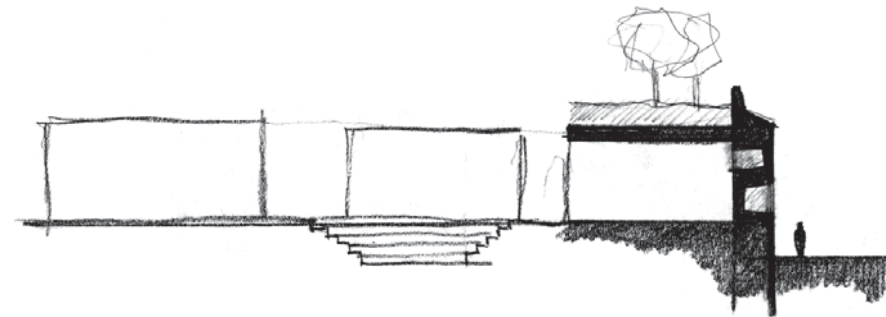
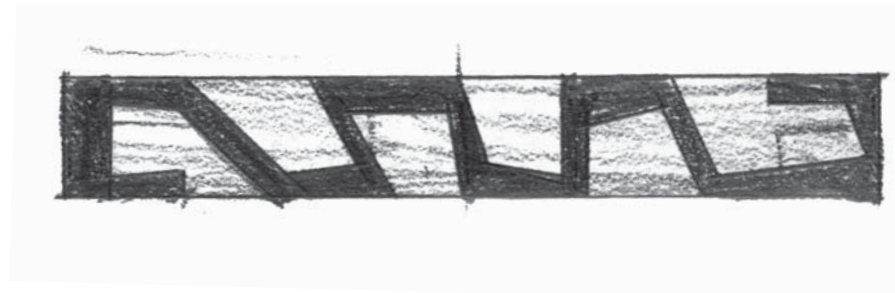
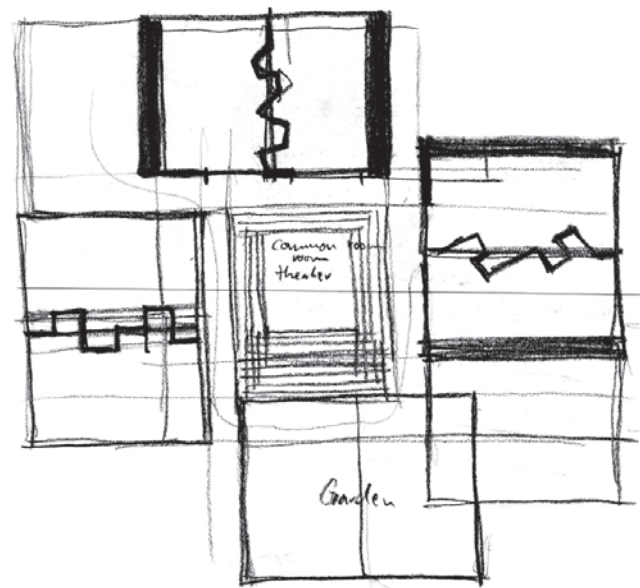

In these building sketches a wall becomes more. Classrooms cluster around a central courtyard are divided from each other by “maze-walls” which children can see as its own world for hiding or play. This private space stands in contrast to the common area which has emphasis placed on its special/gathering functions. Its steps and the flat stage area can turn from a playground to a little performance place.

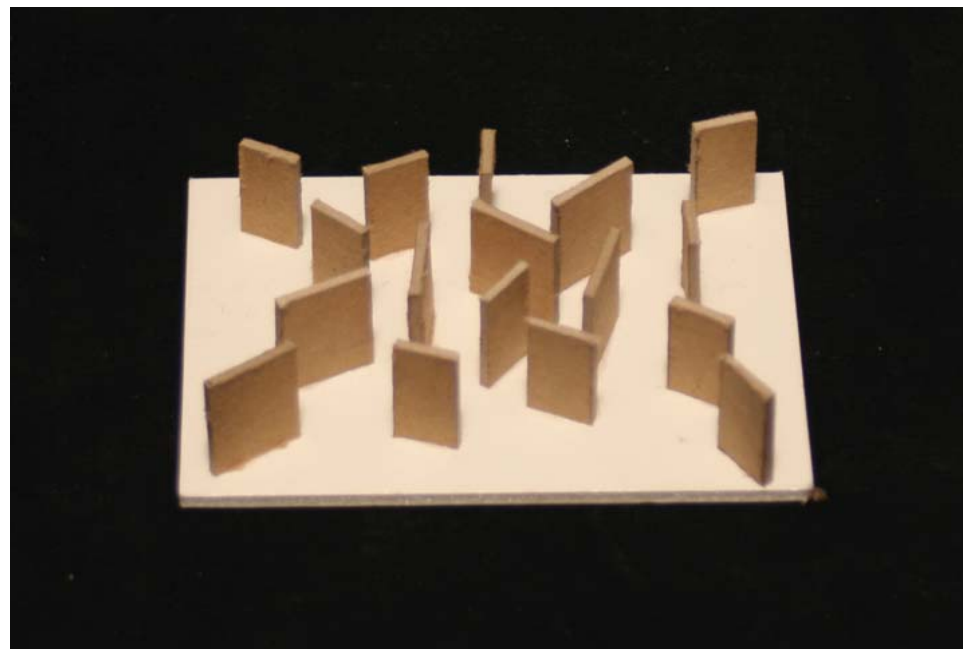

Wall forms were derived from a study of abstracted maze structure

The sketch shows how an existing tree on site can turn in an interpreted tree house idea where children can explore and experience the tree from different points of view. The tree also stands symbolical for a garden and reflects back to the institutional roots in Germany where the word pre-school is translated as “Kindergarten” and means “a garden for children”. (On the 28th of June 1840 Friedrich Wilhelm August Froebel opened the first pre-school in Germany.)

Generic Furniture turns into objects which can go in the imagination of children from castles to spaceships. They create not only adventure places but also spaces with different dimensions, scale relations and receptions.

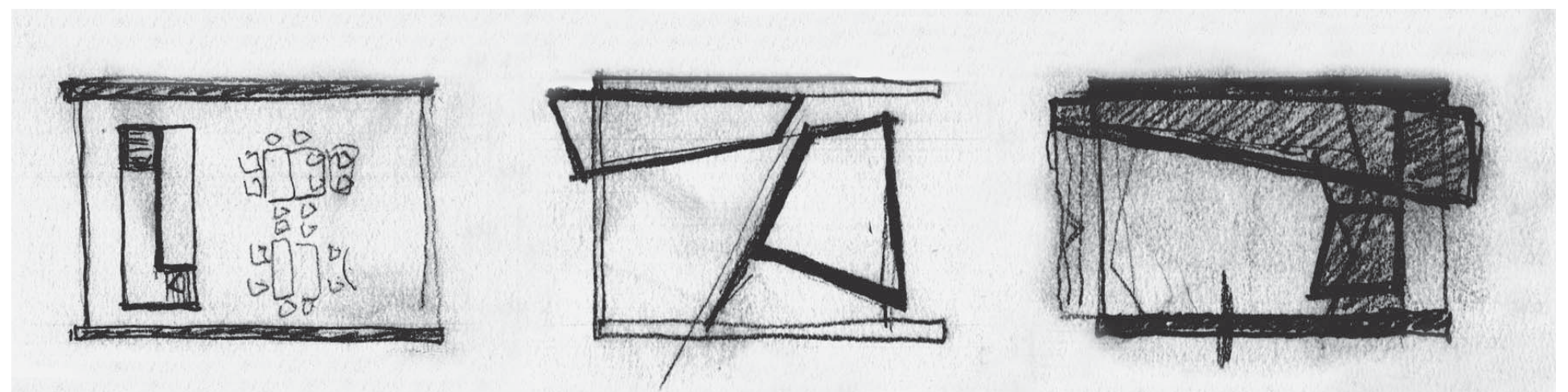
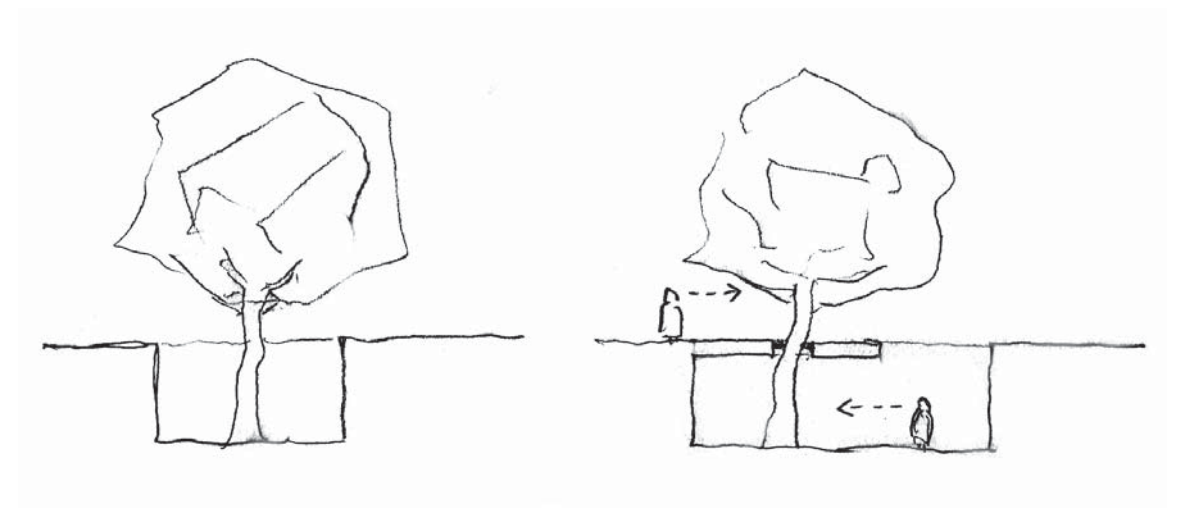

Upper right: studies of tree options in a courtyard; Lower right: Study of sculptural furniture objects in classroom.

Urban Context

The pre-school is located in Old Town Alexandria and takes advantage of its urban setting. An analysis of the urban context was made to guarantee a site in a quarter where the traffic level is medium or low. It also respects the fact that a child's world is smaller and defined by boundaries like streets, a river, a forest and landmarks like a church, candy store, or trees.

The proximity of families to this pre-school location invites parents to walk with their children to the pre-school. During these walks children are more exposed to their environment than they would be in cars. The interaction between their parents who can explain things is also higher, therefore they will come to know the place where they live faster and better.

Site Location

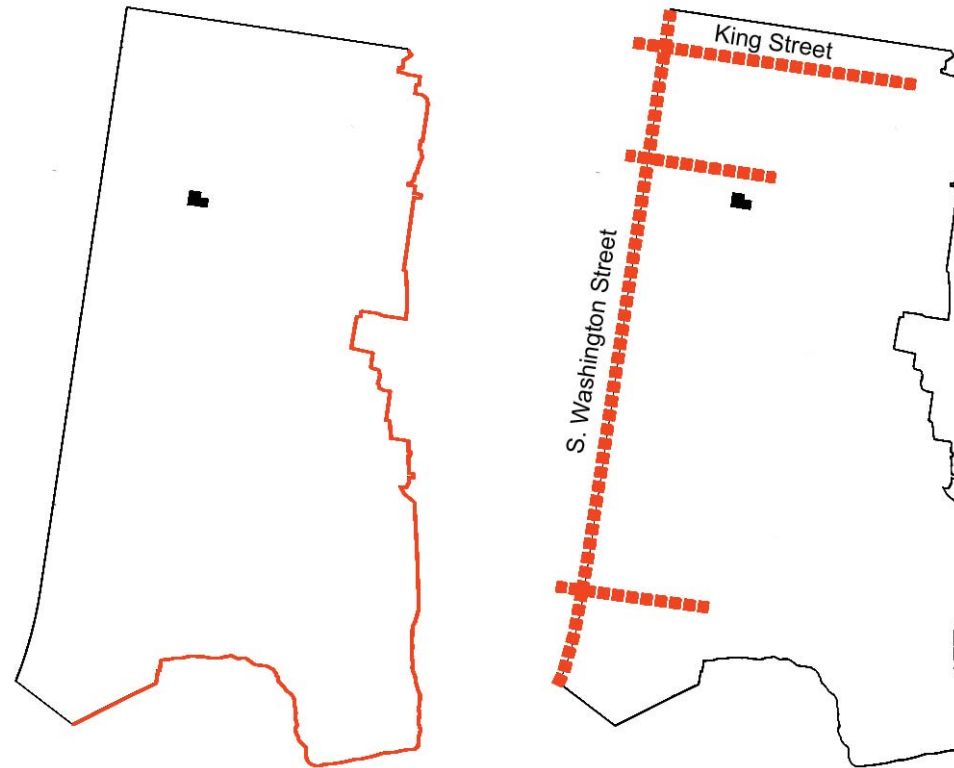

Riverbank - Potomac River

Traffic Boundaries



The boundaries of the pre-school quarter are Kings Street on the North, Washington Street on the West and the Potomac River as well as a Natural Reserve on the East and South. The institution is expected to use the whole area, including its public facilities, playgrounds, waterfront, or natural reserves for its activities. Different professions and institutions like a theatre, a tailor, a bakery, a fire station, a shoemaker and churches are located in this area and can be used as part of an educational program to show how things work and how things are made. All facilities in this area are within walking distance of the pre-school.

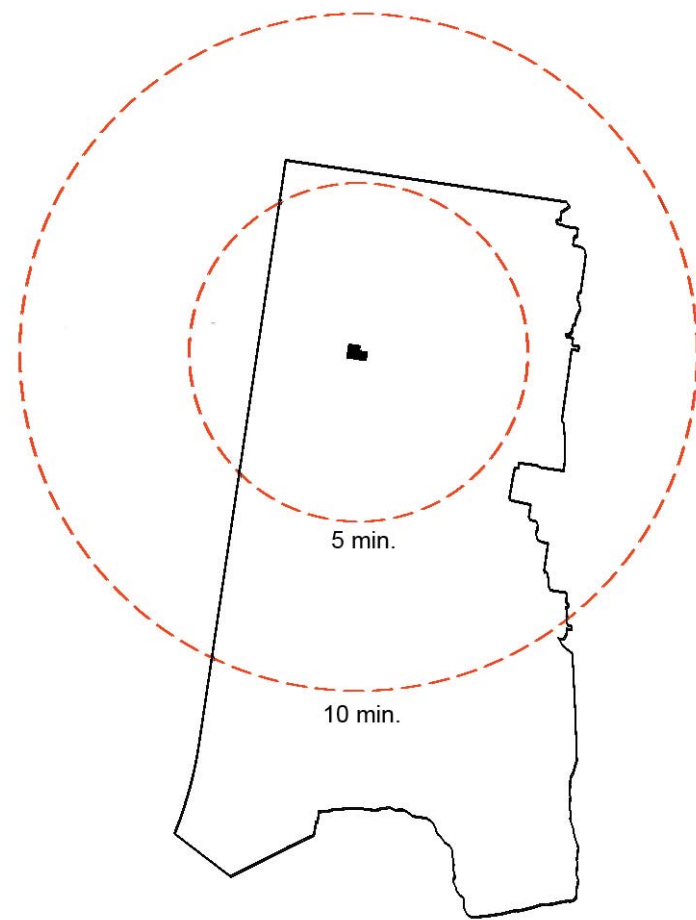

Walking Distances

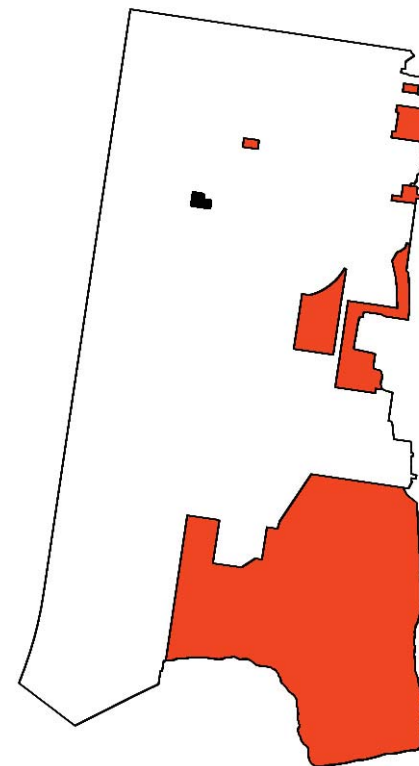

Green Spaces



Landmarks

Site Analysis

A complex site analysis was necessary to understand the location and guarantee that the design of the pre-school will appropriate to its urban context so that both parts will benefit from each other in the future.

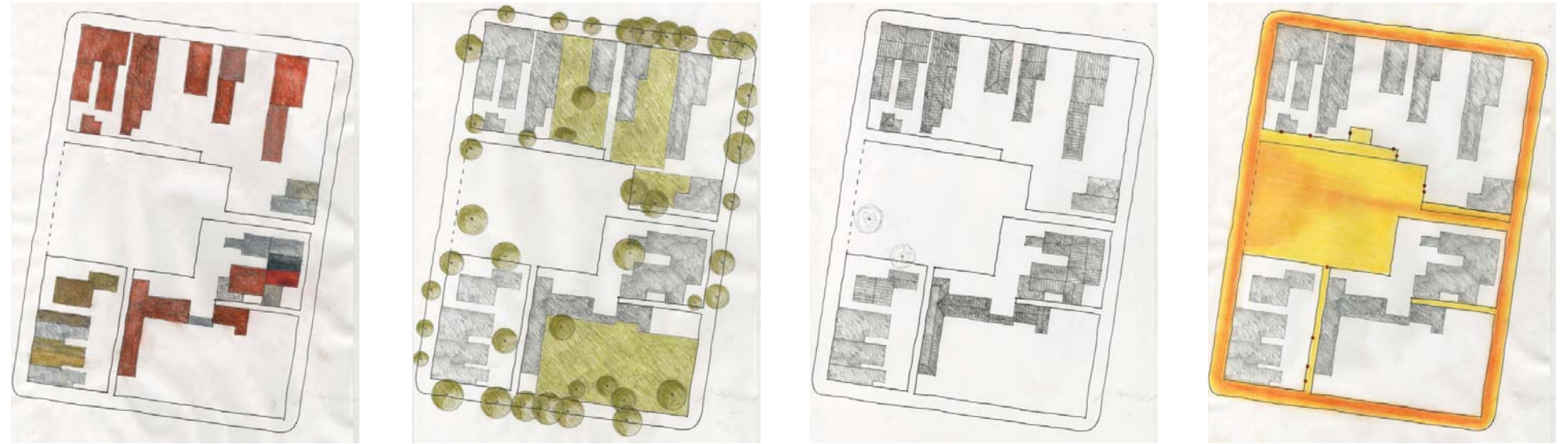

Site from Pitt Street

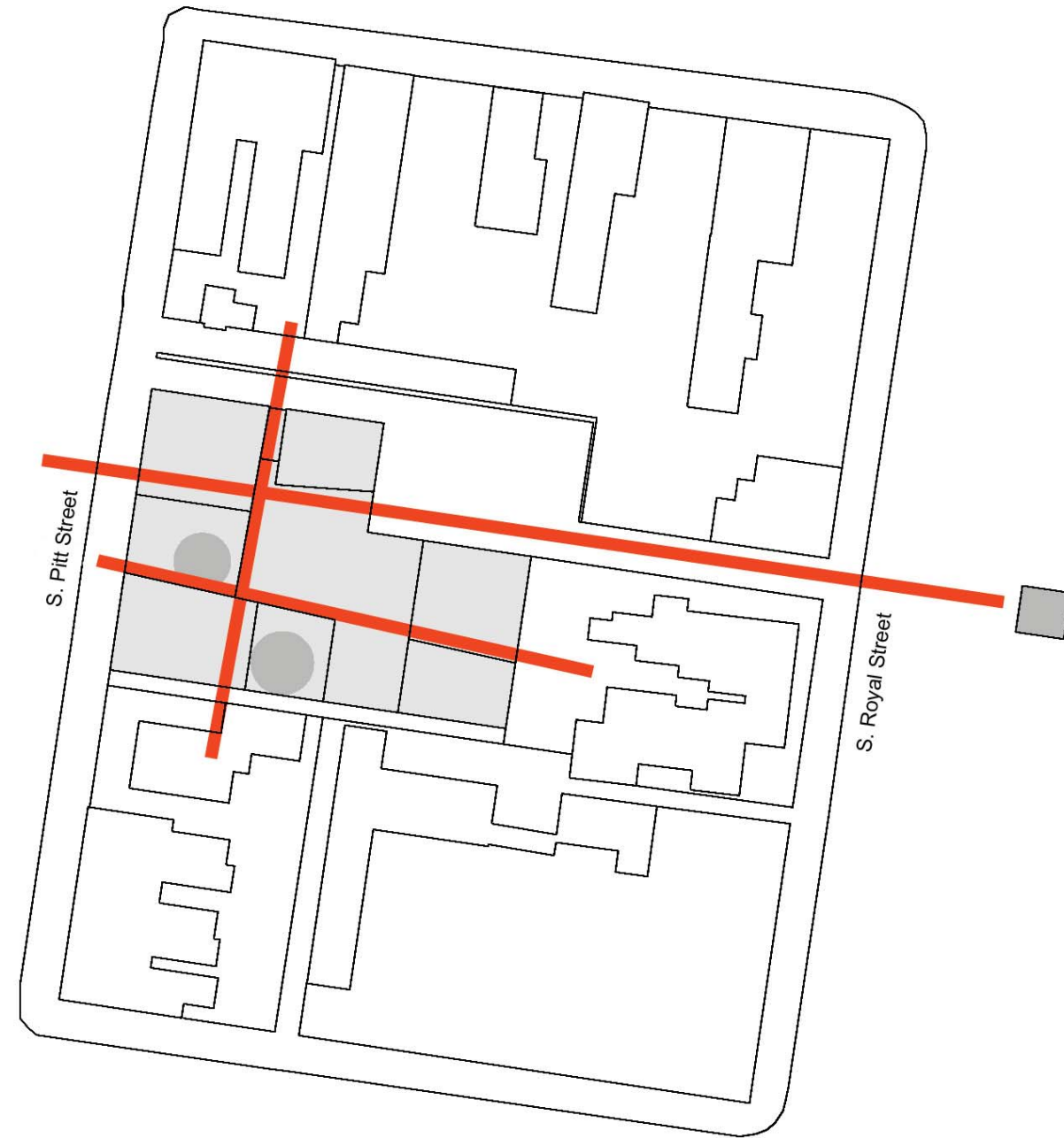

Anchor Points

The pre-school will be located on an existing parking lot which is on South of Pitt Street in the West. The site has access an alley connecting it to South Royal Street on the East. The block is exclusively residential use and the church tower of St. Mary Church on South Royal Street is the most dominant architectural landmark around the site.



Even though the pre-school is located on Pitt Street, the building entrance is on a protected semi-public courtyard. Therefore, you experience a sequence of different views and spaces before you enter the pre-school. The access ways to this courtyard are shifted away from each other and allow many different views across the site. The parochial courtyard creates not only a safe drop-off and pick-up place for the pre-school but also a meeting place for the neighborhood. The stone pavement and different landscape features like a wall with spy holes, stone blocks of various height, and grass or gravel squares invite children to discover and experience the space through sensory experiences.



Parochial Realm



Trees



The building appears confident in its urban situation without losing its connection to the surrounding context. The pre-school design was guided by the church tower as a landmark and the desire to incorporate the two existing Magnolia trees which are on the site. They formed the building concept, its space arrangement and its final character.



Building Concepts

One of the first schemes defines different spaces with different functions and atmospheres – the semi-public courtyard and the elevated private garden are developed in contrast to the public street. The new building is clearly the new element on the site but with its dimensions also tries to relate to the existing street geometries.

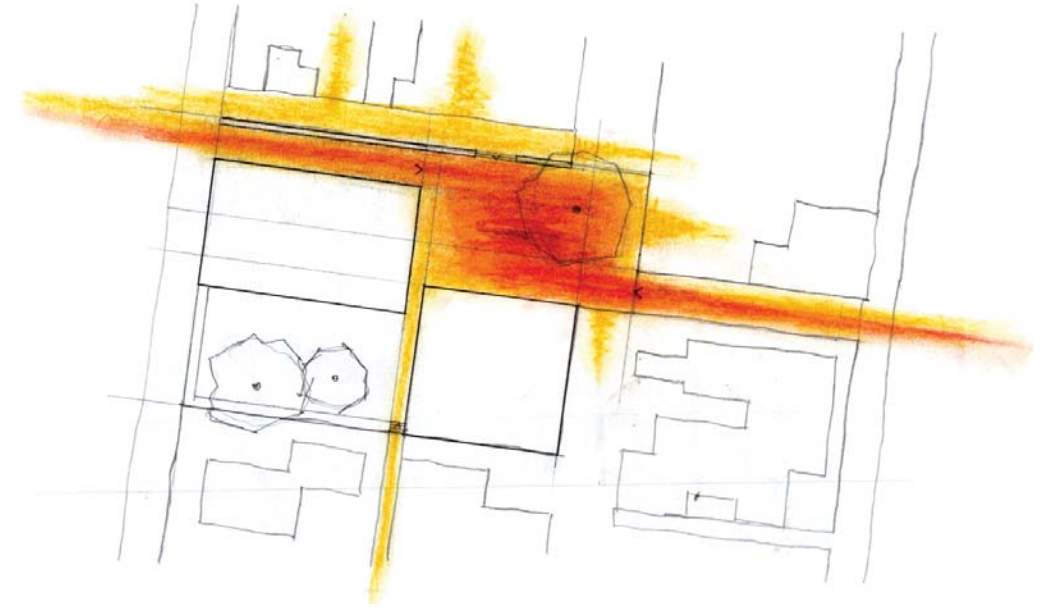

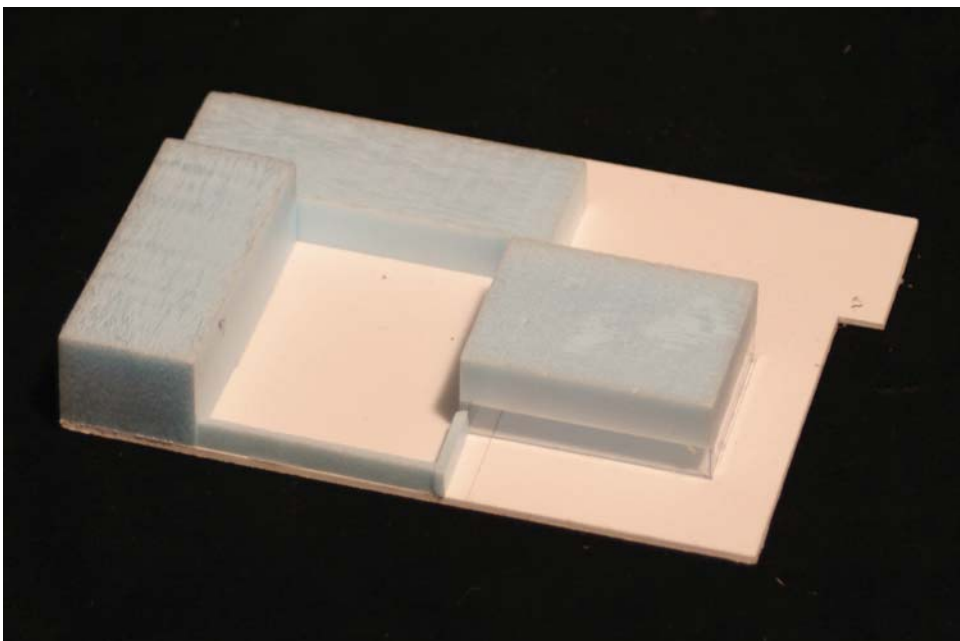
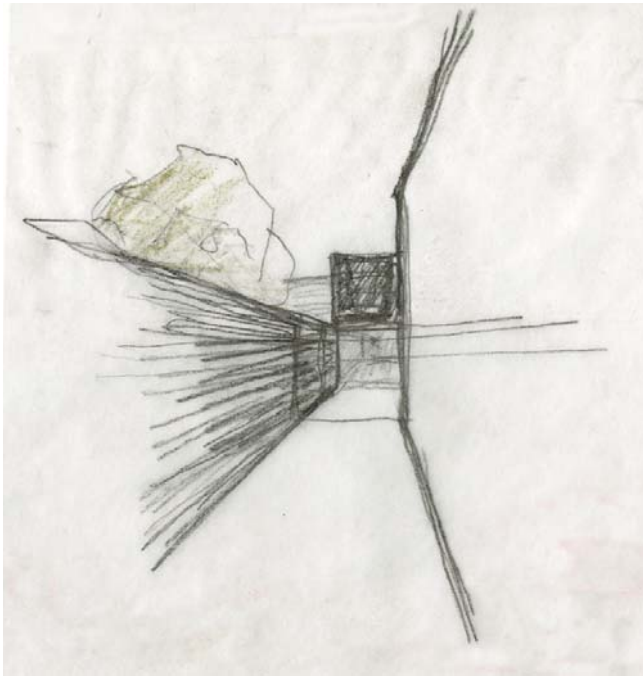

The scheme on the right focuses on the common spaces – the indoor activity zone and the outdoor garden. The roof of the indoor space is lifted and is supported by a light steel structure. The floor level lines up with the public plaza around it. Just the window glass separates the both areas. Curtains can be used to block the view between spaces if necessary. Glass doors can open up to the plaza as well as to the outdoor garden and can create an unified outdoor-indoor area and can be used for special events like a summer festival. The disadvantages include the detached and unrelated position of the interior activity zone to the class rooms. Also the classroom order is hierarchical, they are not very efficiently structured, and the design also sacrifices one of the two existing Magnolia trees.

This design focuses on preserving the two Magnolia trees. It also includes multiple gardens with different atmospheres and elements for different uses and ages.

The classrooms on the ground floor level are two stories high and connected a roof terrace with a large common garden.

Other than the gardens that include the two Magnolia trees, the design is not really related to its urban context. The labyrinth-like character of the building makes the orientation from inside difficult. The classrooms are not very efficiently connected, and the arrangement of the classrooms and gardens don't leave space for a bigger indoor common room.

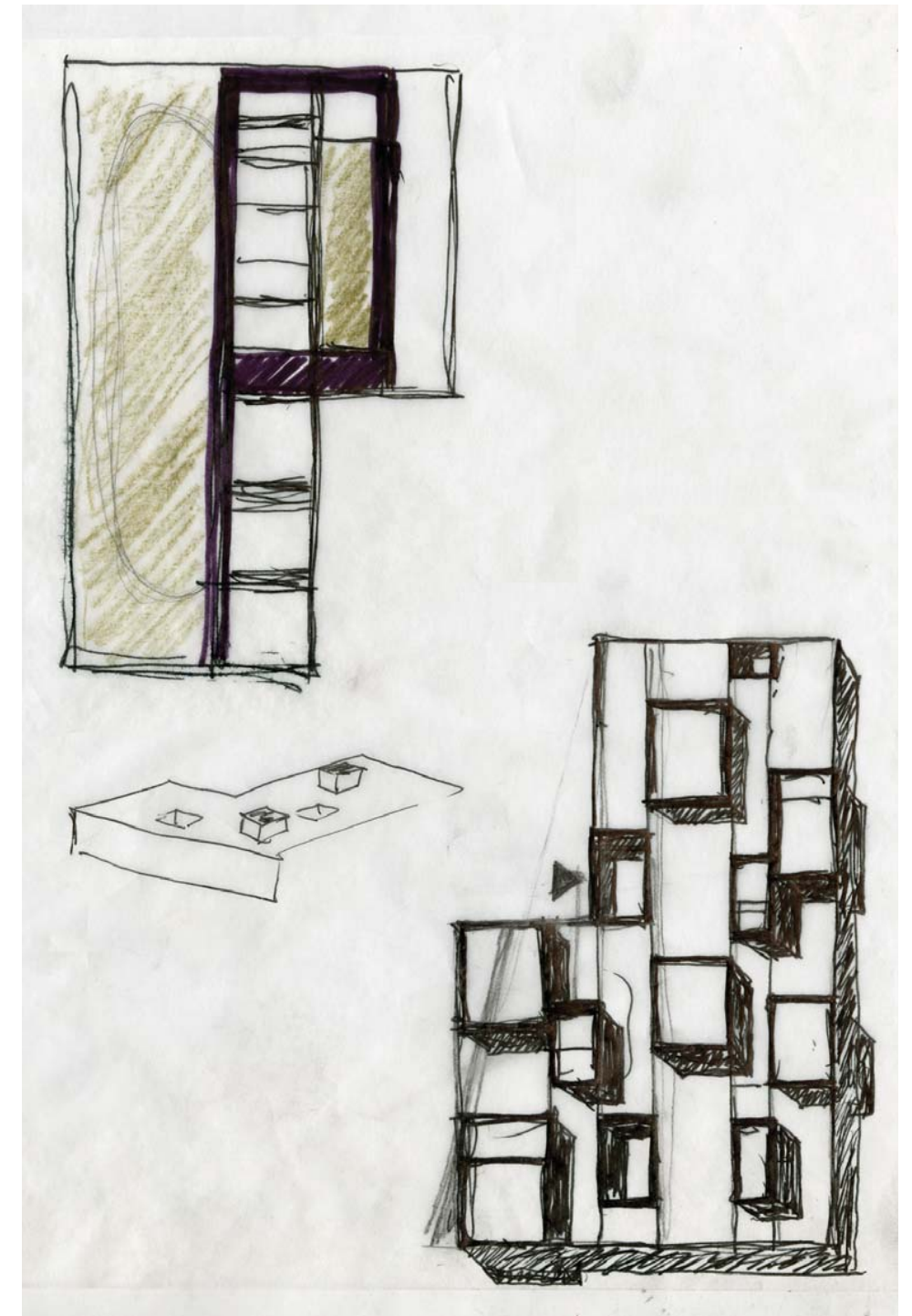
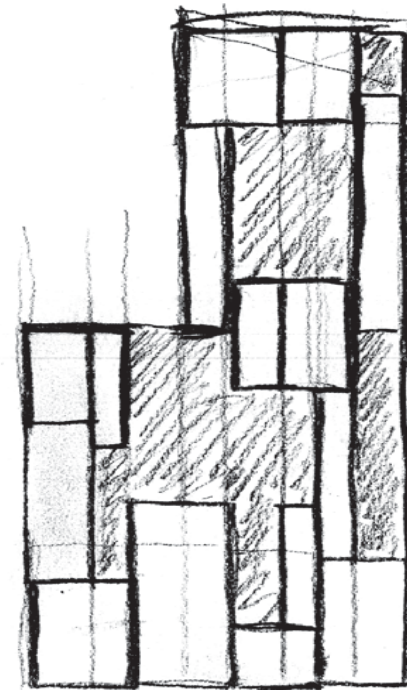

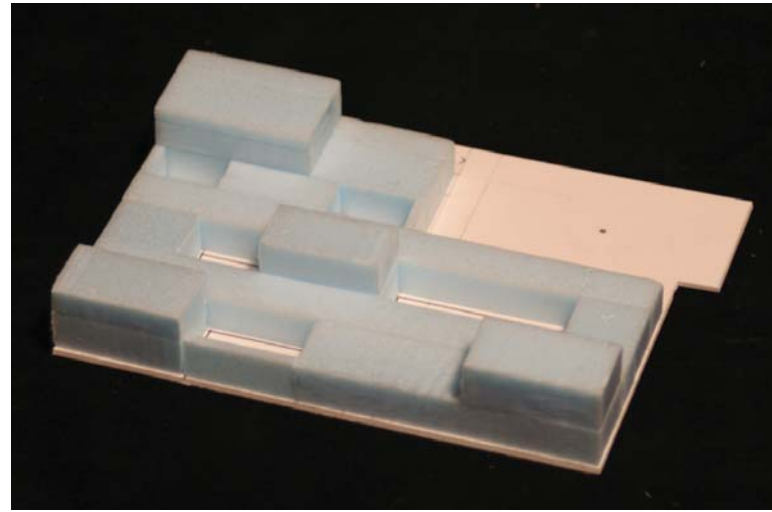
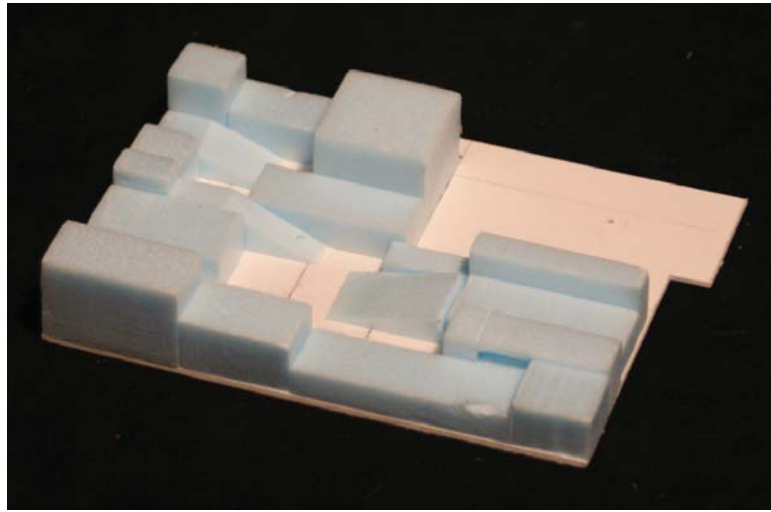

The next design has a strong focus on a centrally located common room which is not only functional but also maintains a high symbolic value. A connection between common area and individual classrooms is the main character of this scheme. The building layout also includes the existing trees in its three more private gardens which are directly connected to a classroom unit. The units include two classrooms and define a specific age group. Therefore all three class rooms have different functions, finishes and characters even though they are all based on the same design concept. The common room is the first space which you see when you enter the preschool. It can be used by all groups and offers enough space for bigger events throughout the year. It could even be used by public organizations after-hours, e.g. meetings, elections, discussions.

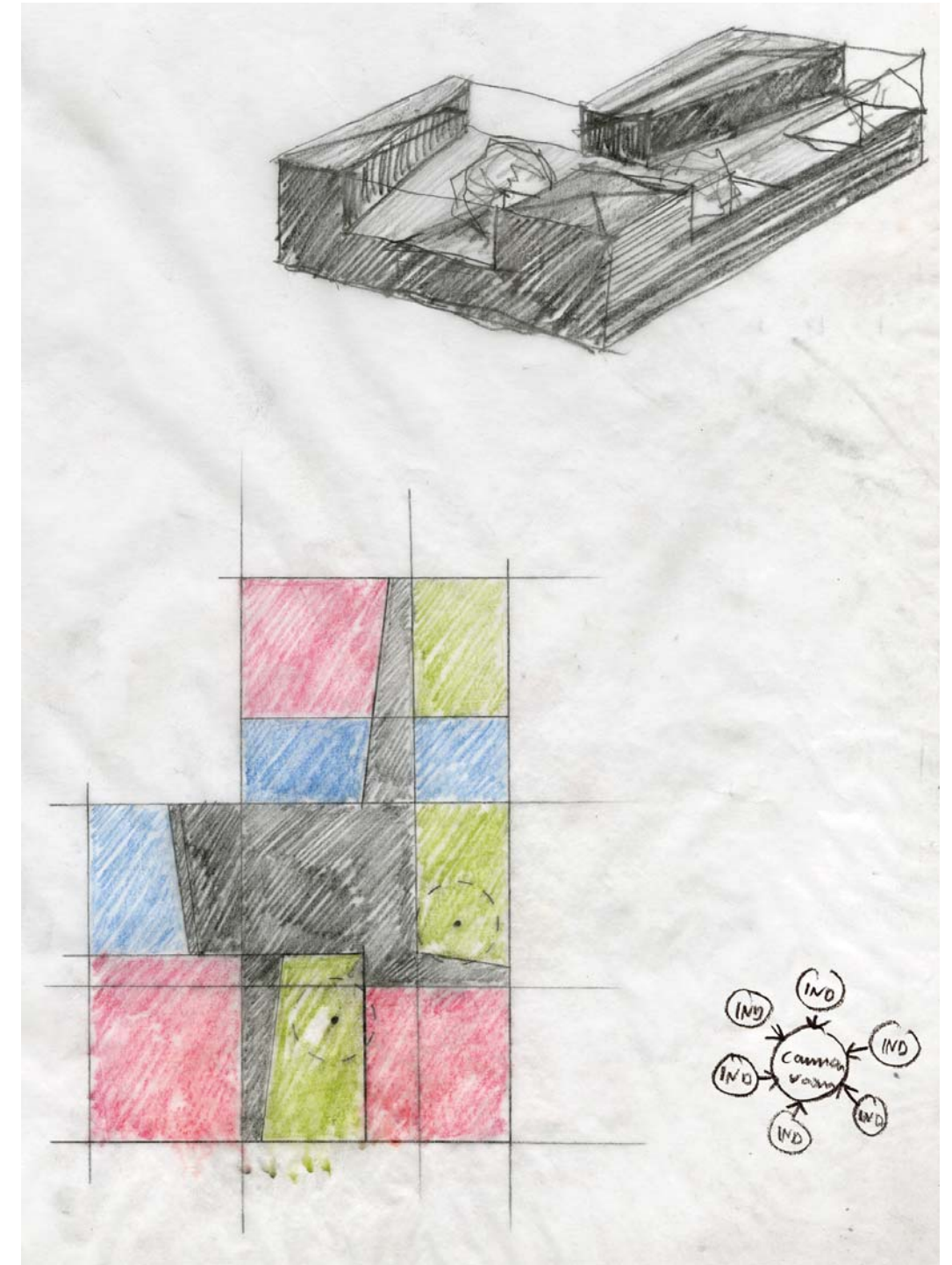
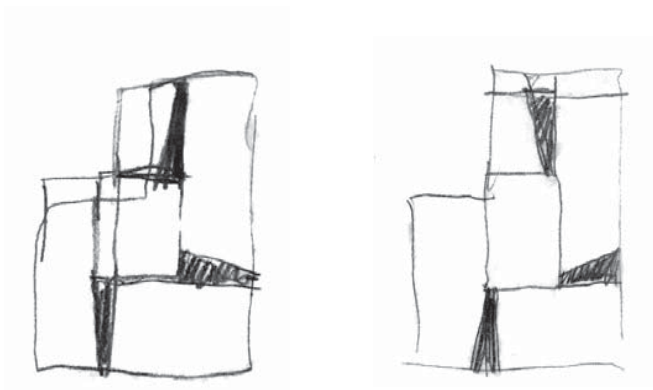

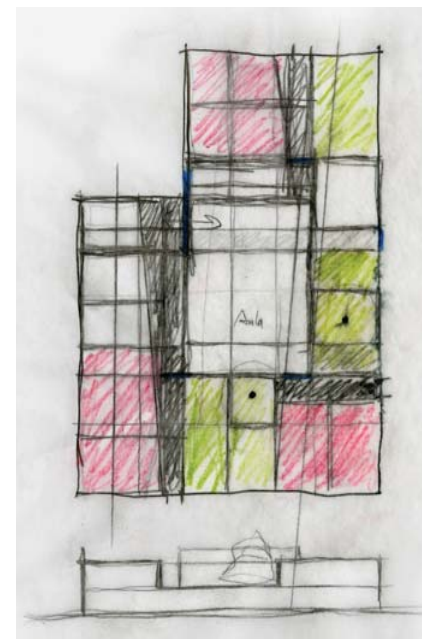
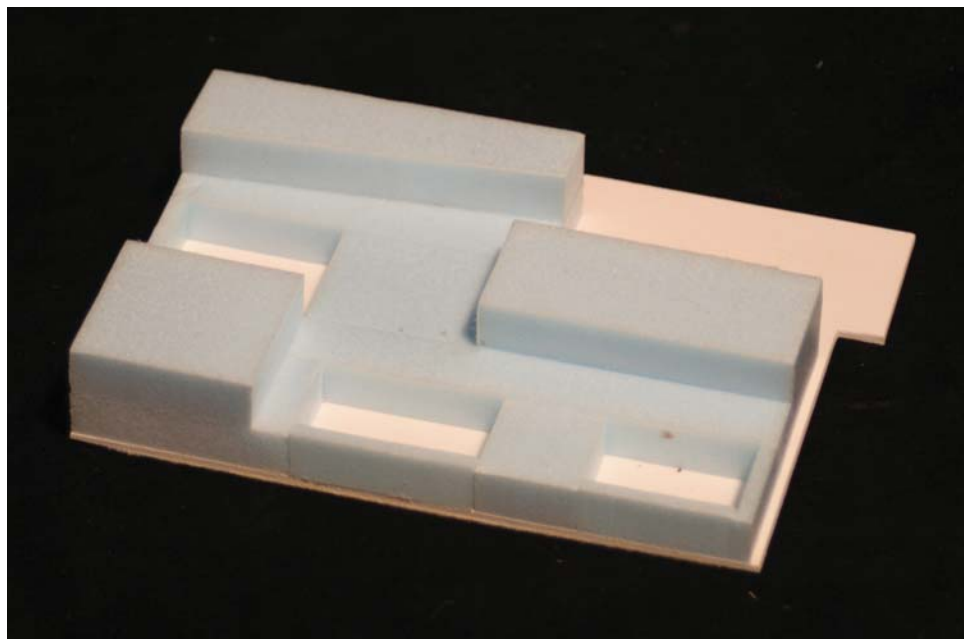
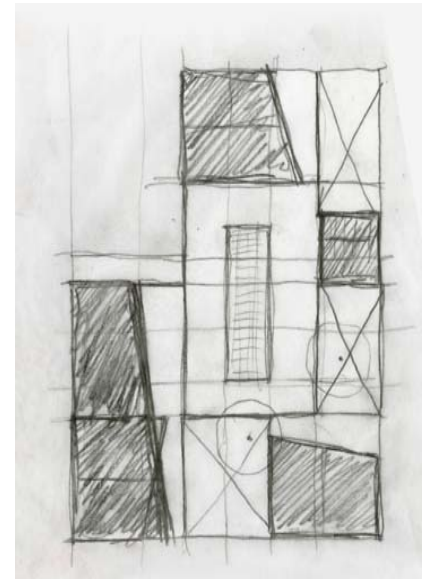
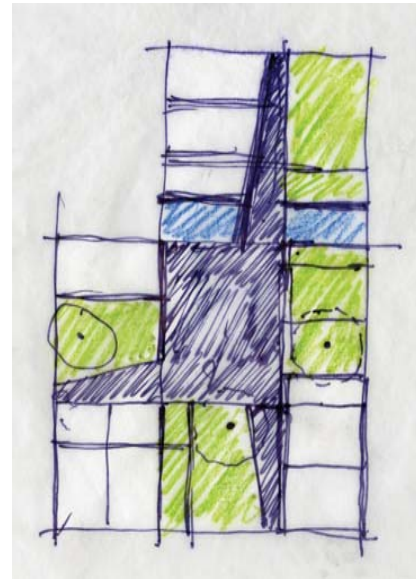
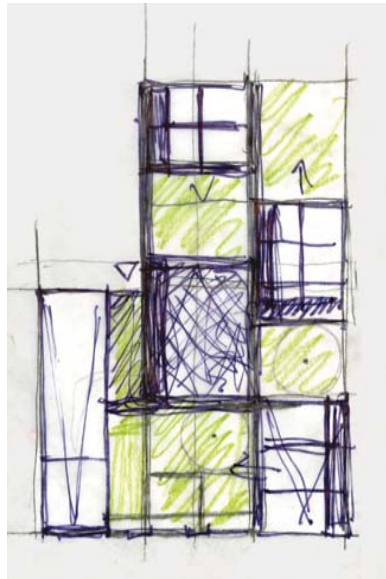

Each classroom is two stories high and includes a mezzanine level which connects to the roof terrace. The outdoor roof terrace creates the equivalent of the indoor common space. It offers enough space for all kind of play activities. The more individual classroom garden is smaller and has, like the classroom itself, an age specific design. All three gardens are on ground floor level, include a bigger tree, and provide a more private atmosphere which the roof terrace can not offer. These trees are also elements of the roof terrace, just from a different perspective. And even though the children won't be able to climb in them, on the roof terrace level they will experience the idea of a tree house where you are above ground, with the branches and closer to the tree top. Therefore the roof terrace not only offers more space for the outdoor activities at the pre-school but also gives the children a different view of their environment and different impressions.

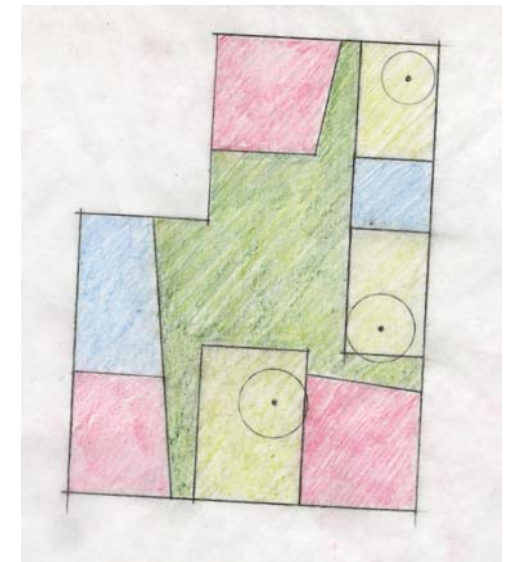
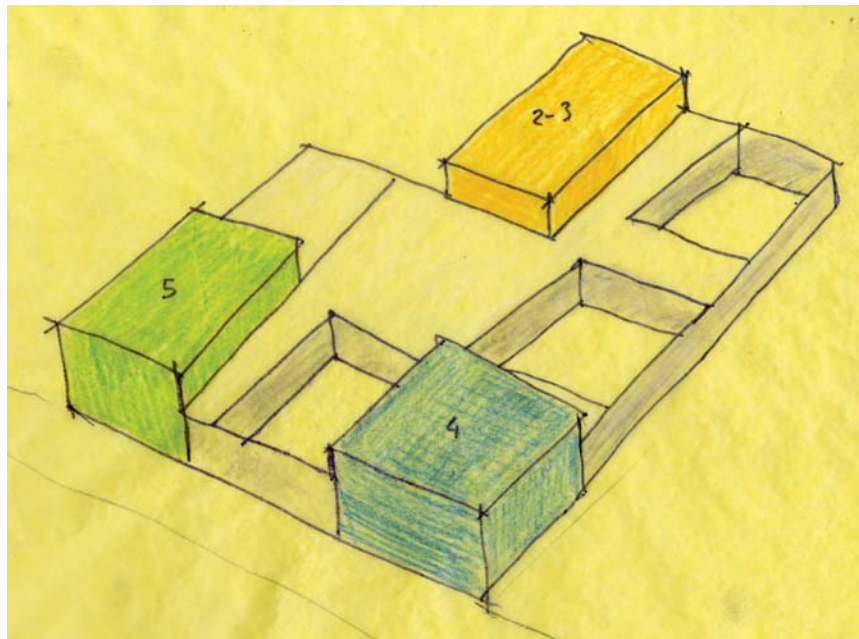
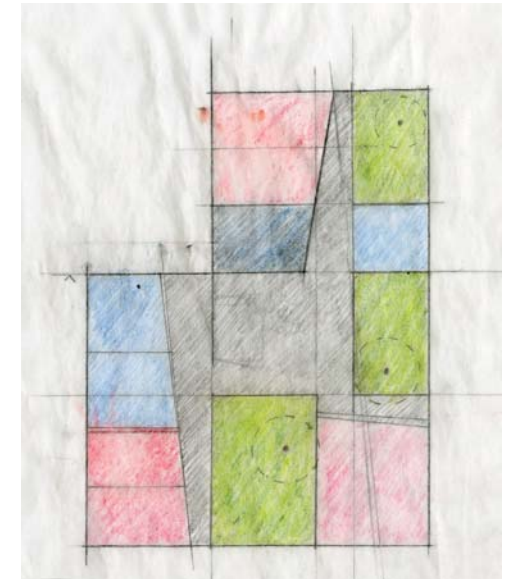
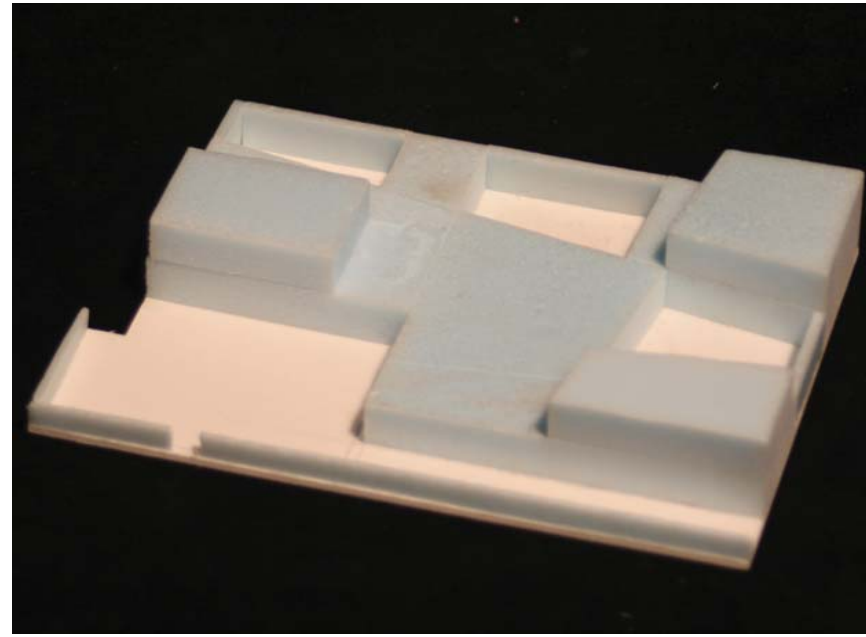
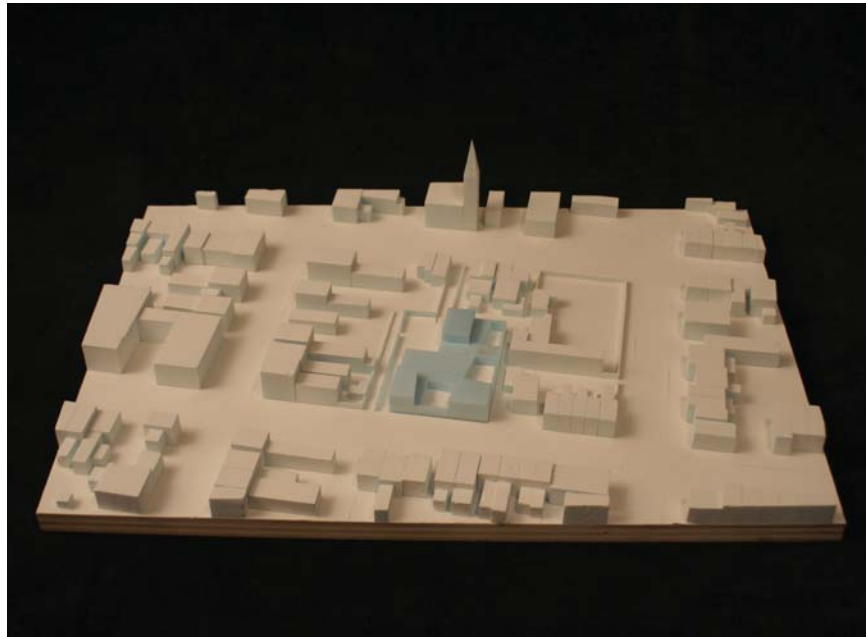

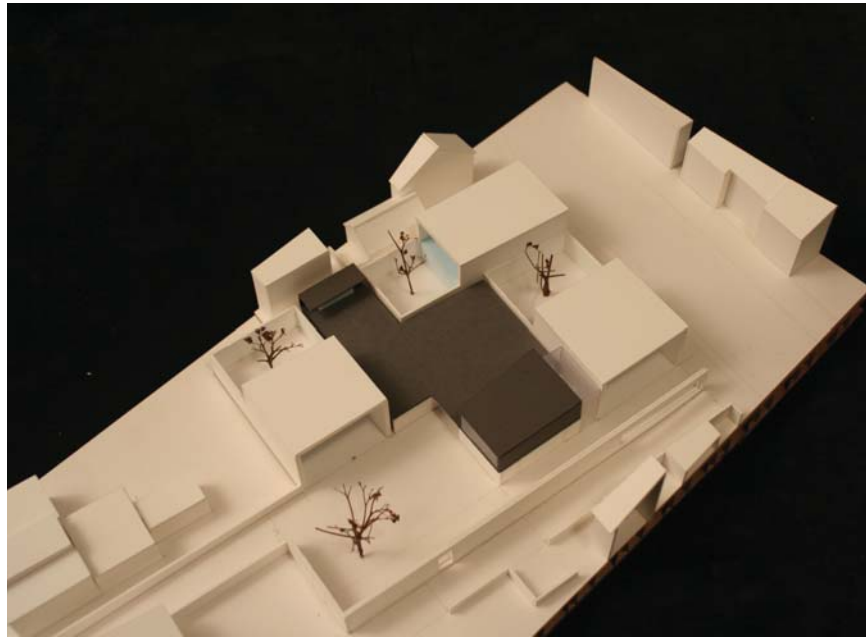

The terrace is also connected to the common room by a larger stair and an elevator. Since the design included two levels it was necessary to provide roof access for handicapped children and adults. The elevator also makes it easier for the teachers to move equipment between the two floor levels. The Roof terrace also includes a covered section with sliding glass doors on the south side. This area has a big sand box and can be used with closed doors during the winter too. The glass layer on the south allows the low winter sun to warm up the room inside. In the summer the glass doors open and the roof above the sand box provides a structural sun protection. An open grill stair ensures that sand is not carried down to the wood floor of the common area.

The relationship to the urban context is in this scheme also much stronger than it was in the previous designs. The pre-school is not the only new element on the site, the planned plaza is a parochial zone that creates a new urban space for the entire block and its neighborhood. The potential of this quality is completely missing in the current parking lot. The model shows how the small plaza is connected from two different streets - Pitt and Royal Street.

The alleys meet the plaza on different corners. With views of the church tower of St. Marry Church this shift creates a more private plaza than a straight alley line would do.

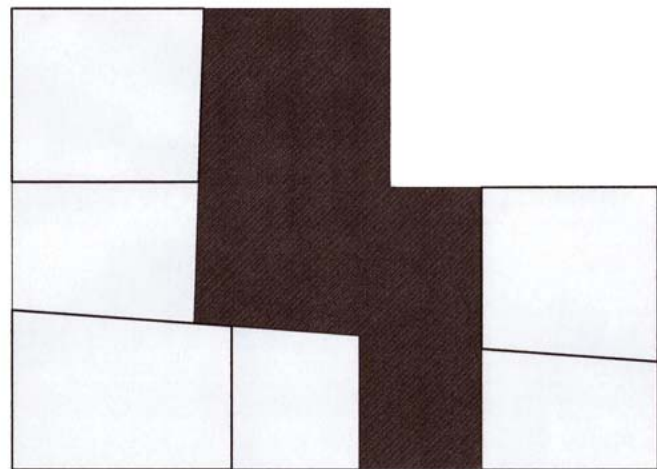

common room

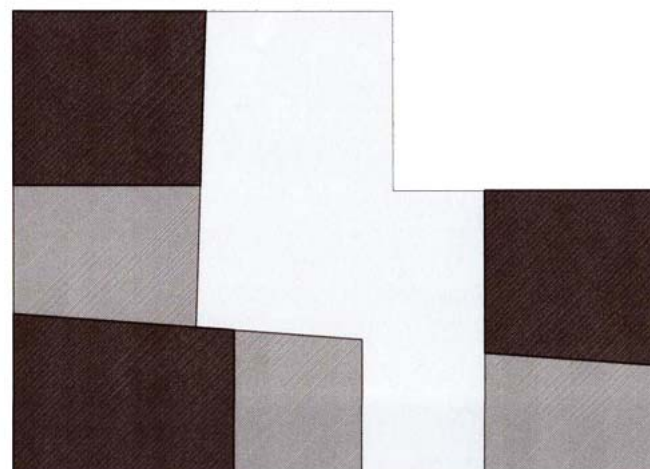

classrooms

Building Design

The classrooms and the common room are defined by built-in furniture. The furniture's design remains constant throughout the pre-school, but varies in material and size depending on its classroom unit.

Different material, ceiling heights, and open and more enclosed areas result in diverse spaces with special atmospheres. The intention is to create stimulating spaces with specific qualities for specific needs while remaining subtle enough for their design intent to be received unconsciously. The attraction of the human senses is always present without becoming dominant.

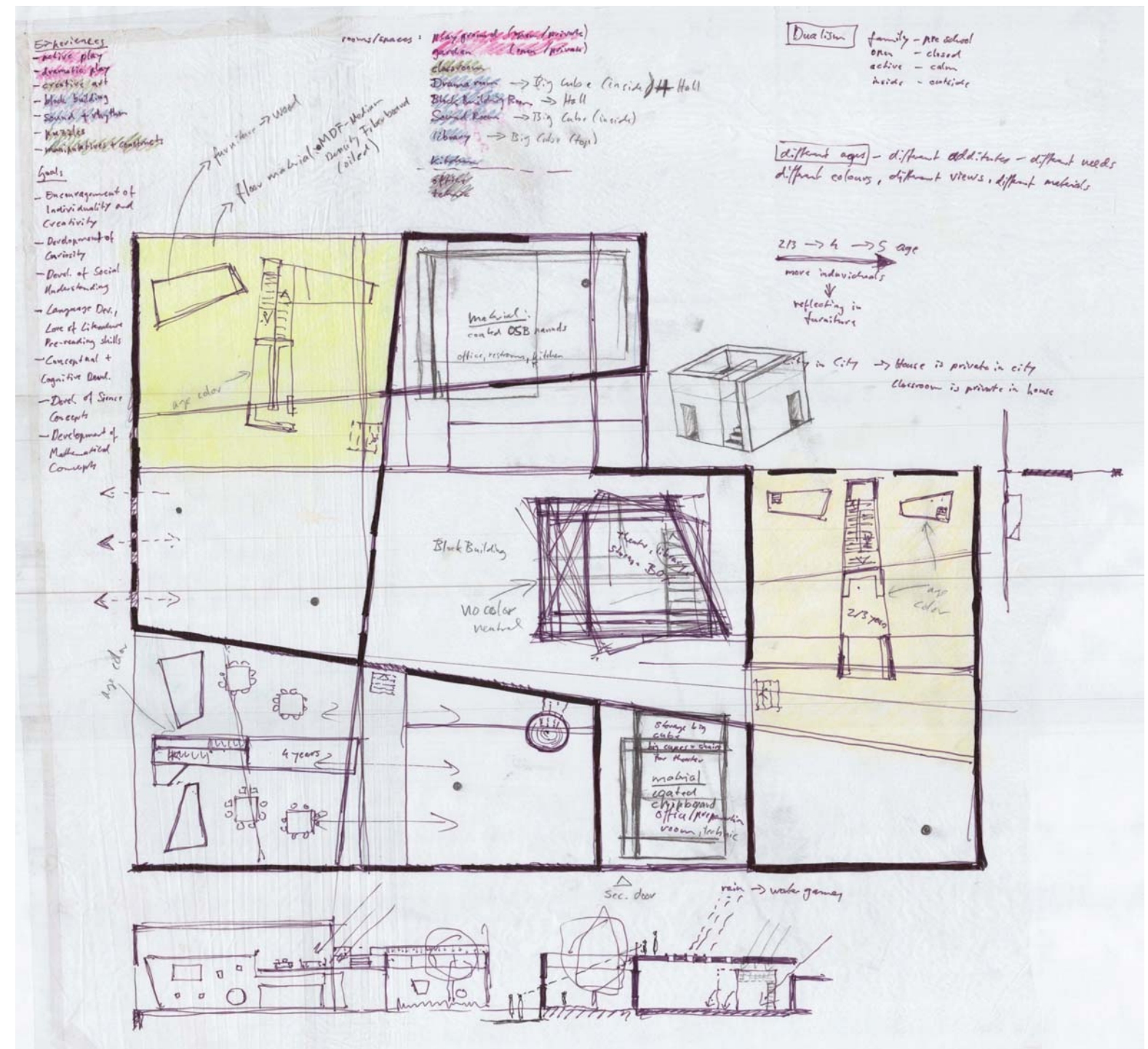
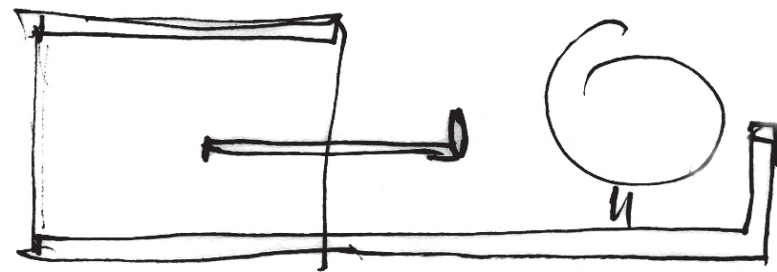

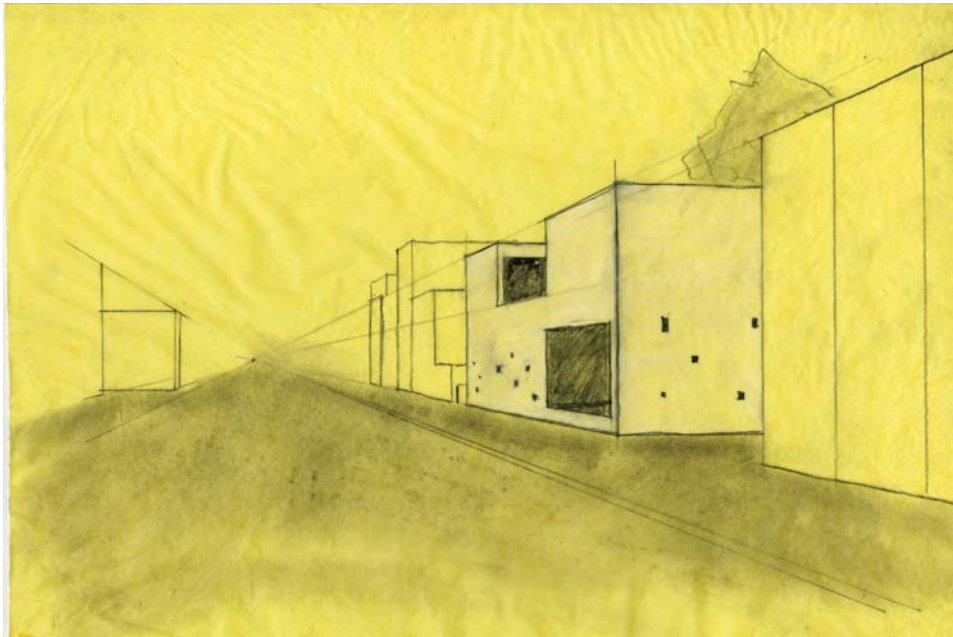

The oversized “show window” is a characteristic feature of the building facade. Some of the concrete walls have small, “secret windows”, which are in contrast of the “show windows” and focus on specific details around the building. Through these views the world appears focused-in on its own fascinating beauty.

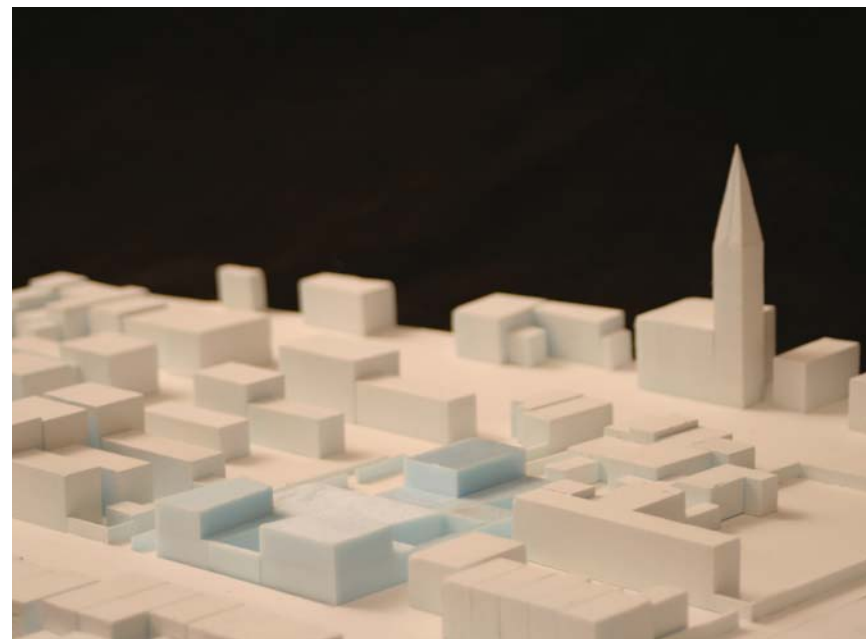
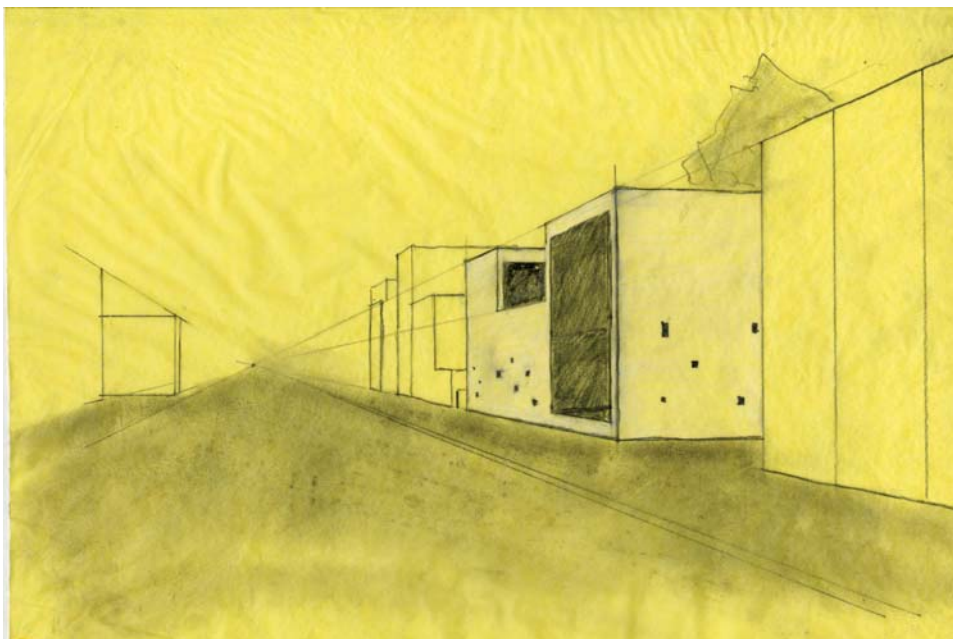

The concept models show the design process from classroom volume to a specific idea of the classroom space. The section shows the different room heights created by the wooden mezzanine level. The classroom walls are made of structural concrete and create a hard, cold contrast to the smooth, warm, aromatic wood surfaces of the furniture and the mezzanine structure. The section also shows the connection between private classroom area and a garden area with one of the two remaining Magnolia trees. Furniture close to the show window protects the inner classroom area from views, while still allowing enough space at the window for more public activities.

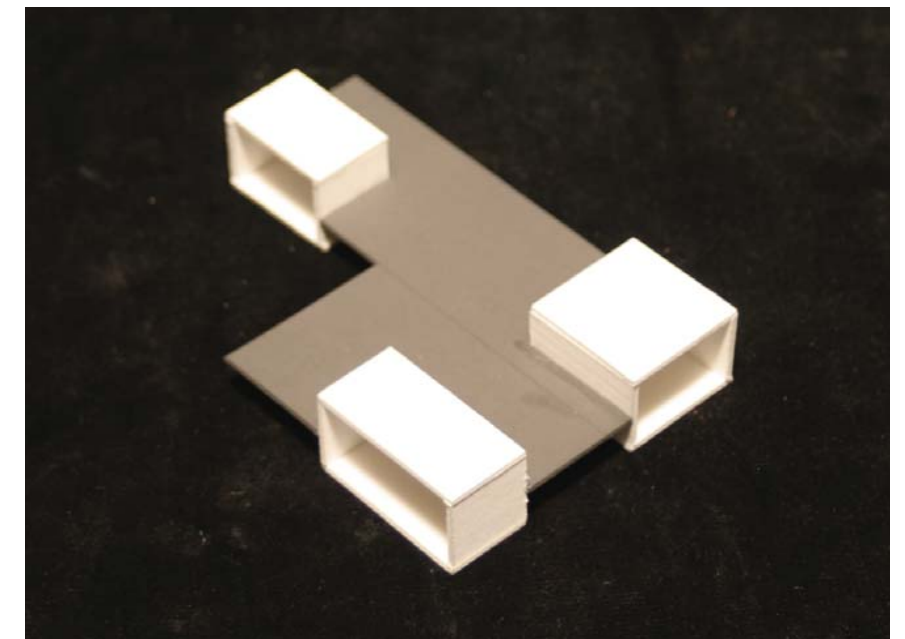
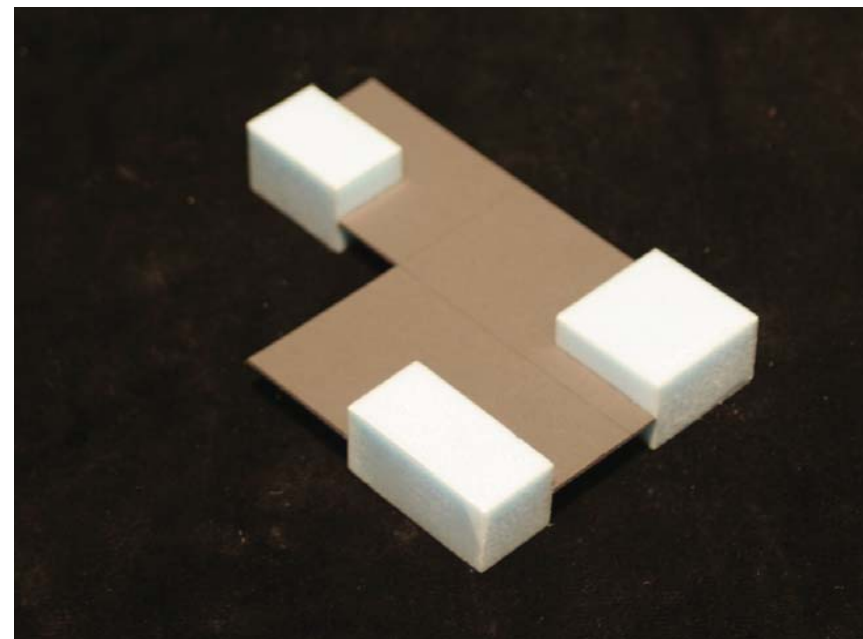

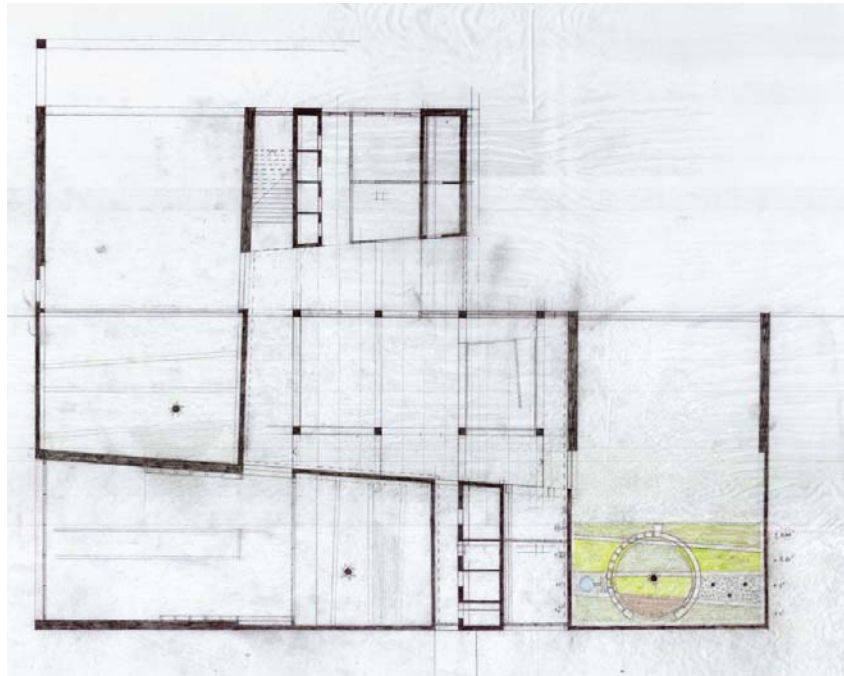

The floor plan shows the three class room units, gardens, and the central common space. The youngest age group will have the most private classroom with a window facing the plaza. The middle age group is also sheltered but they can see more of the busy street life and the public sidewalk. The classroom of the oldest age group, children who will soon go to Kindergarten will see most of the public life. The classroom order follows the idea how children learn about their environment one step at a time.

This plan drawing also shows the structure of the different areas. The thin classroom walls have to carry a free spanning roof. The columns in the center support the entire roof terrace. The column grid also helps to define the huge common space area. The thinner walls which define the gardens don't have any structural function.

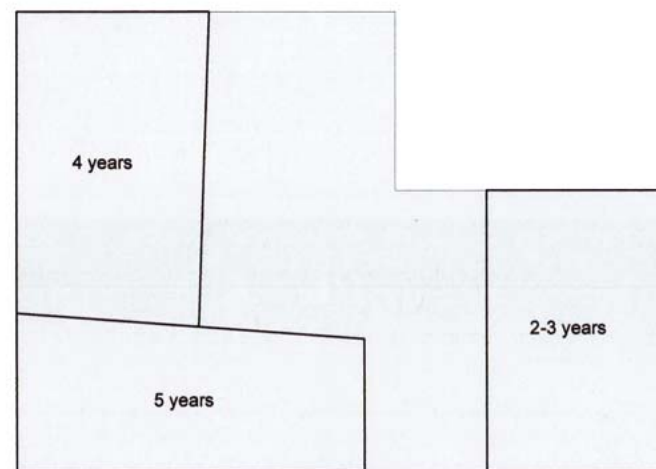

age groups

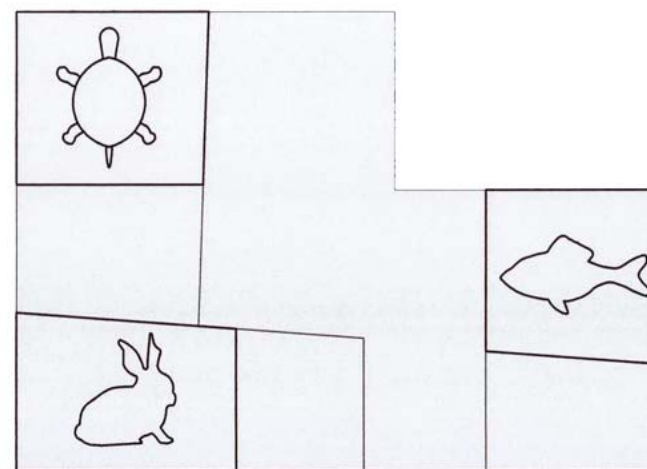

animal totems

Building Structure

The roof of the common area, which is also the roof terrace, is only supported by columns. To emphasize this structural concept the roof doesn't touch the walls around the common space, which have only a space defining function in this point. A structural gap creates the necessary distance between wall and roof. A glass panel lets light inside the space and changes its reflective character depending on the time of day and weather.

The ceiling of the common room has areas with and without wood panels over a waffle ceiling, and indicates different functions in the common space.

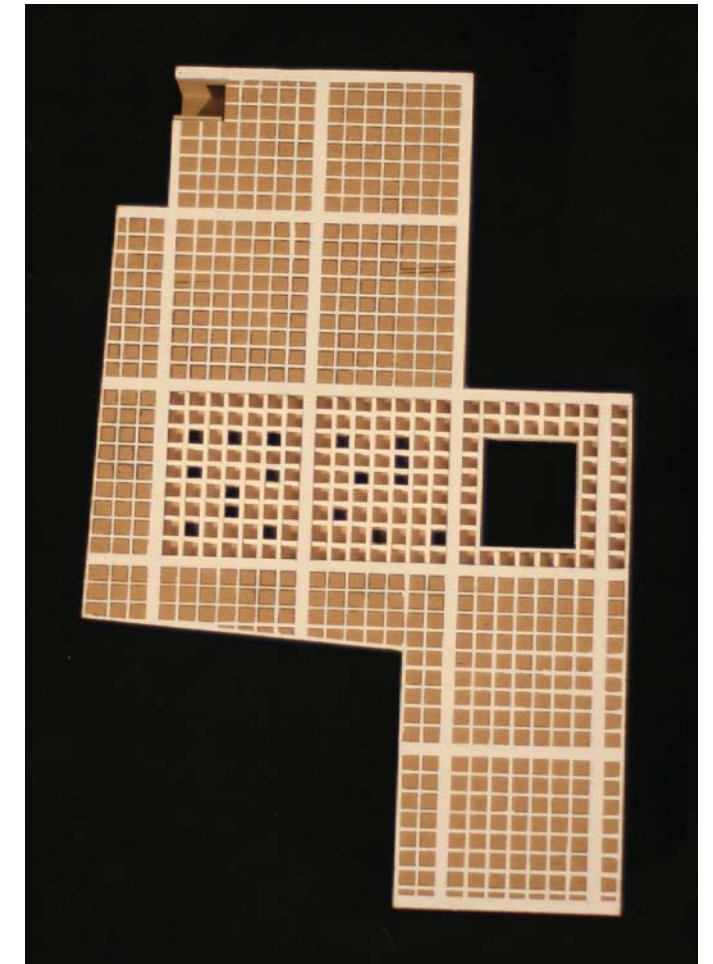
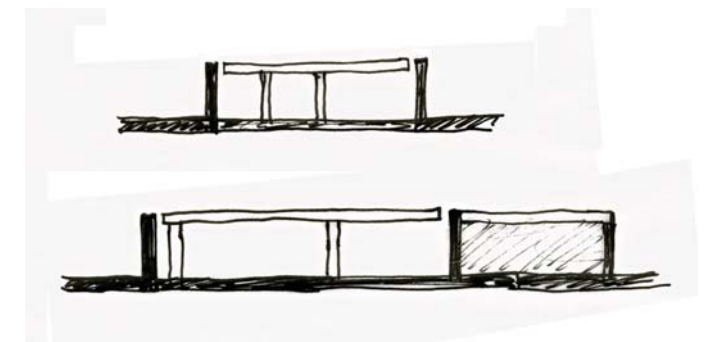
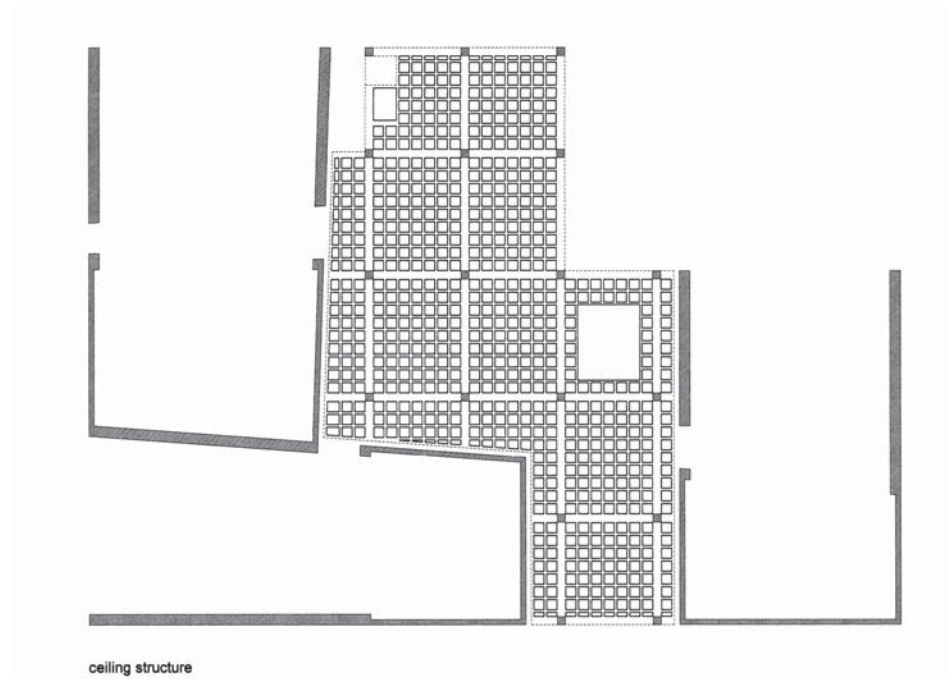
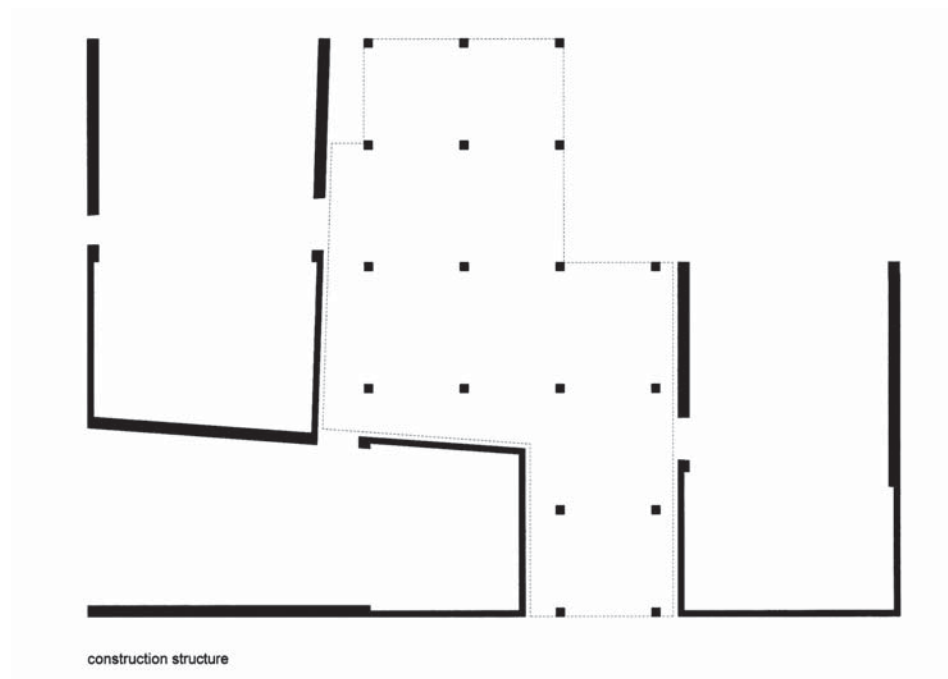

Light Concept

The common space is the first place which the children and their parents pass when they enter the building in the morning. Children also play in this room during the day, and see the room before their parents pick them up. The place will always be the same but the time and moods of the people and children change during the day. Different colors in glass windows and skylights are aligned to the sun path and create different atmospheres inside the common area over the course of the day. The morning appears fresh blue. The noon hours bring very focused red spots of light which can be used for play or just for observation. And finally, the afternoon will have a soft yellow light which ends the pre-school day in a calm mood.

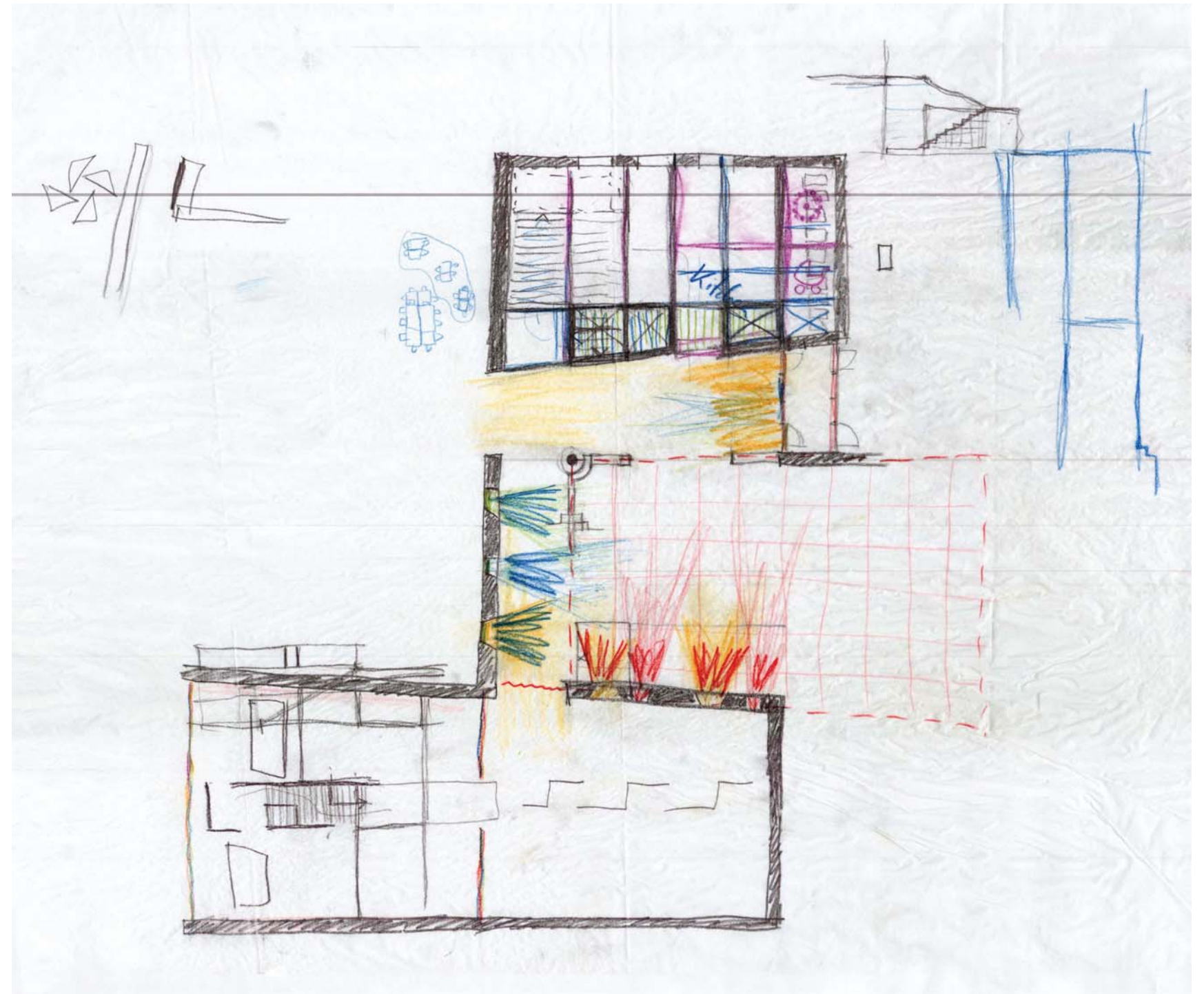

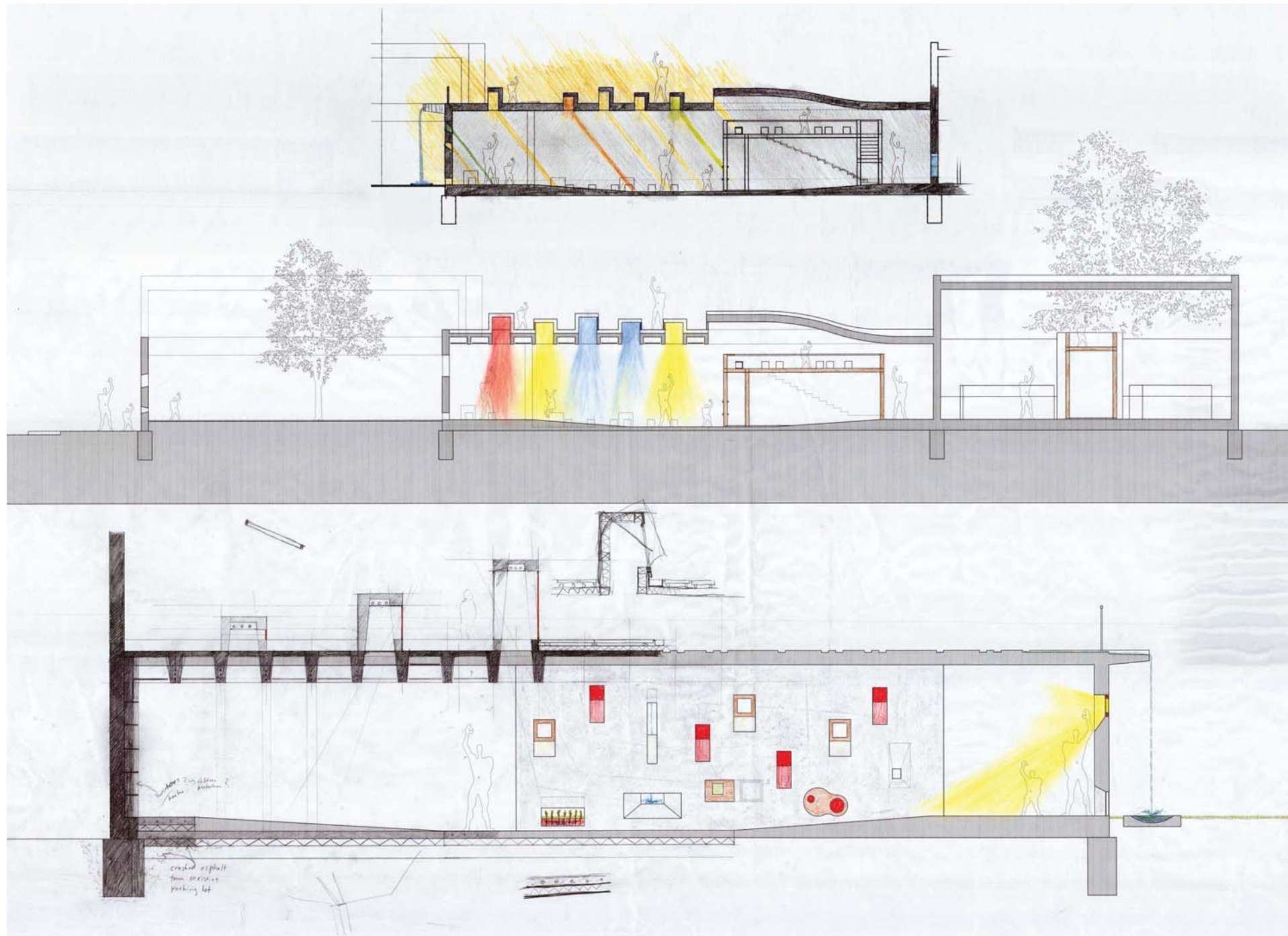

The ceiling grid also defines the skylight positions. The arrangement of the different colored skylights is in a random pattern but is always related to the sun path and the daytime-light color concept. Therefore, the east facing skylight will have blue glass, the red glass panels belong to the south oriented skylight and the yellow glass is for the skylight facing the west. The different heights of the skylight structures create not only different light intensities inside the common room but also an interesting play-world for the children on the roof terrace.

Models used with artificial and sunlight helped to study the light concept.

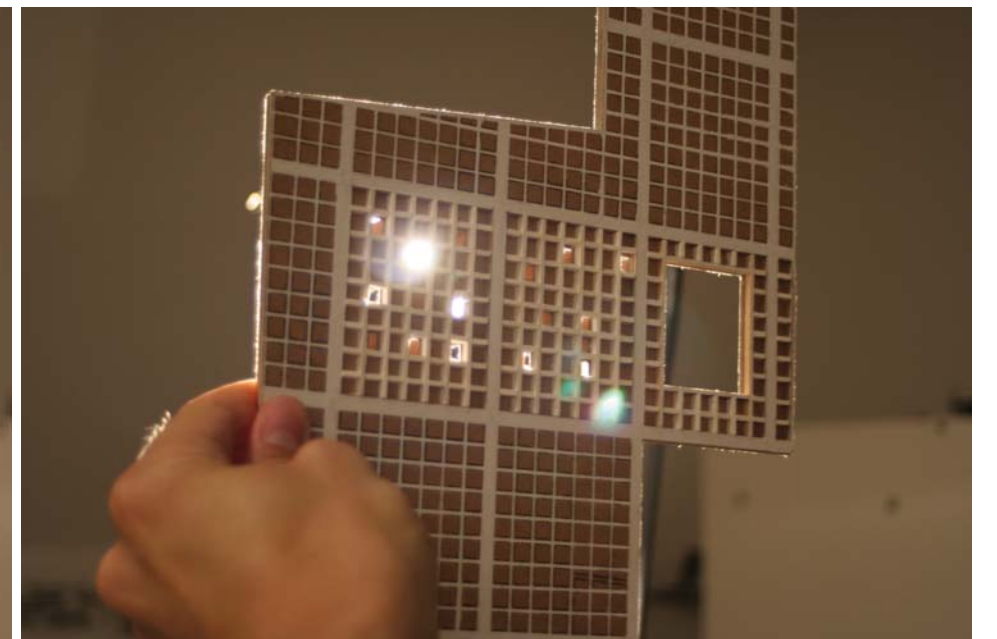
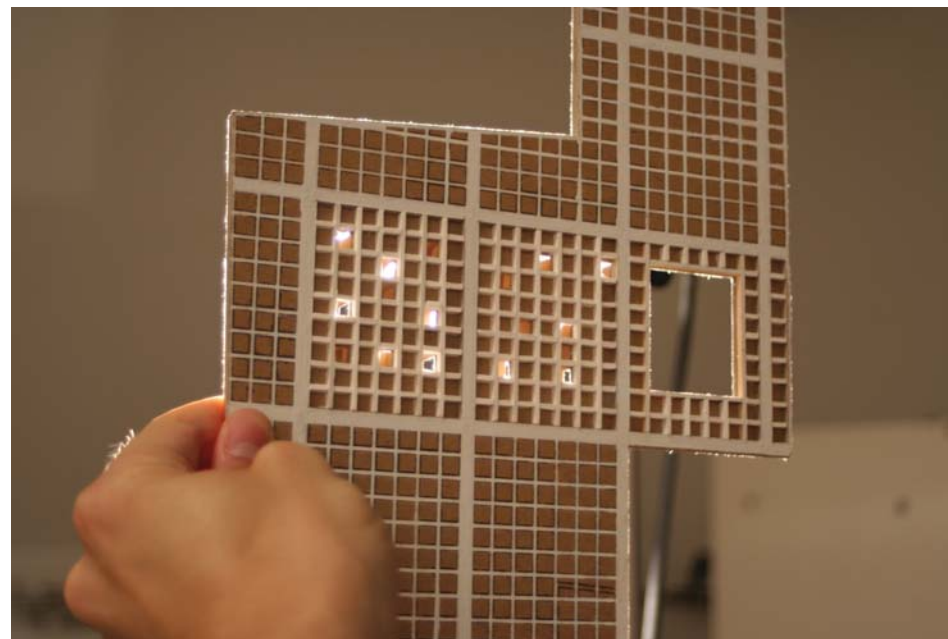
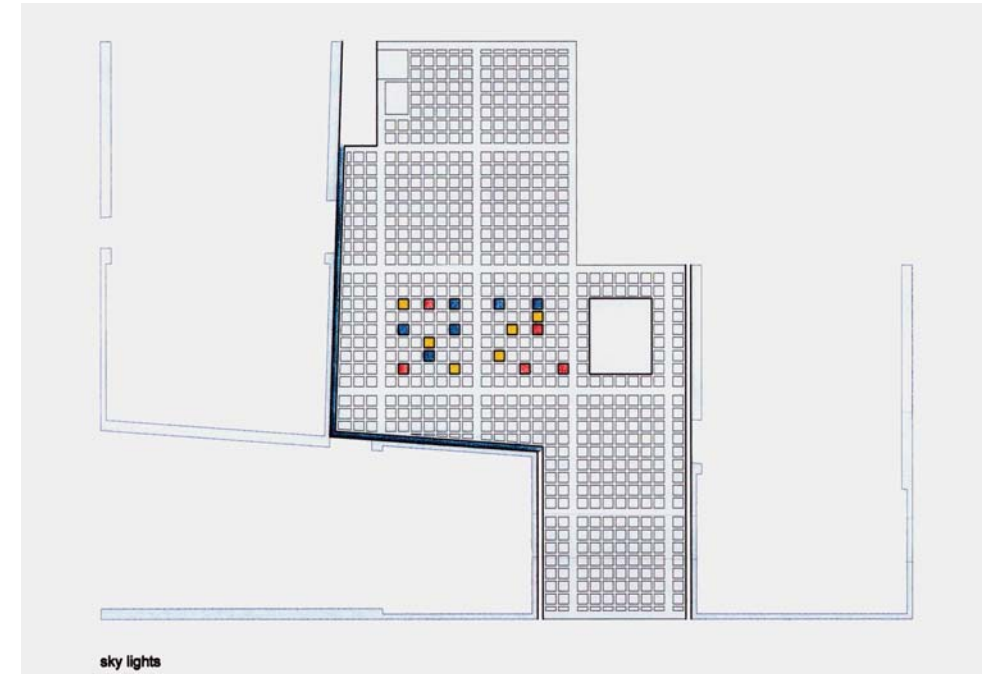



The structure of the skylights is wood to keep the weight as low as possible for the roof structure. Light fixtures inside the skylights can be used during the wintertime or to special events in the evening. Not only will the inside space be illuminated but also the roof terrace which will become recognized as a completely “new” space.

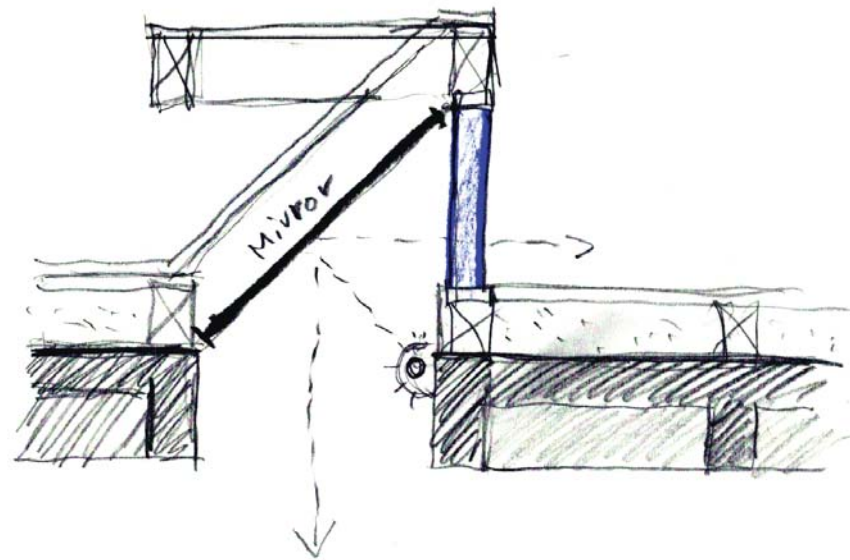
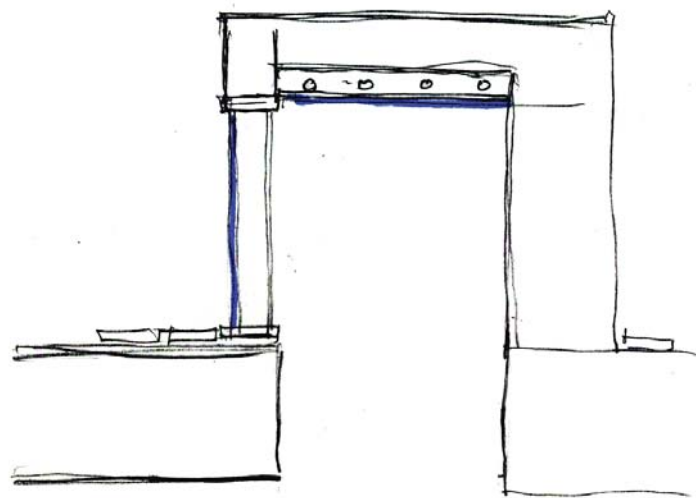

This model shows the three different stages during the day – morning (blue light) – noon (red light) – afternoon (yellow light). The colored glass windows will be arranged in a different order and number as shown in the model but the effect will be the same.

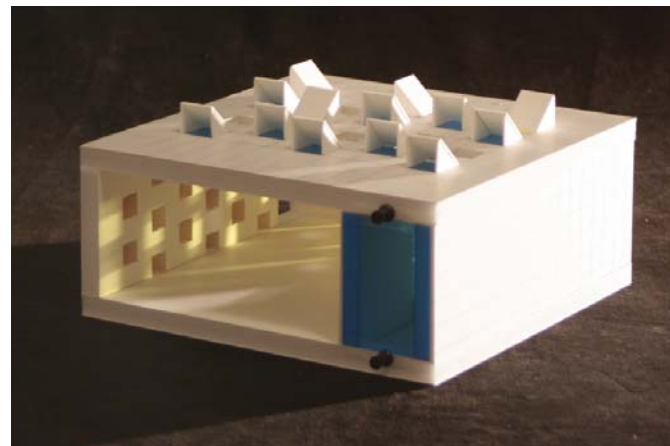
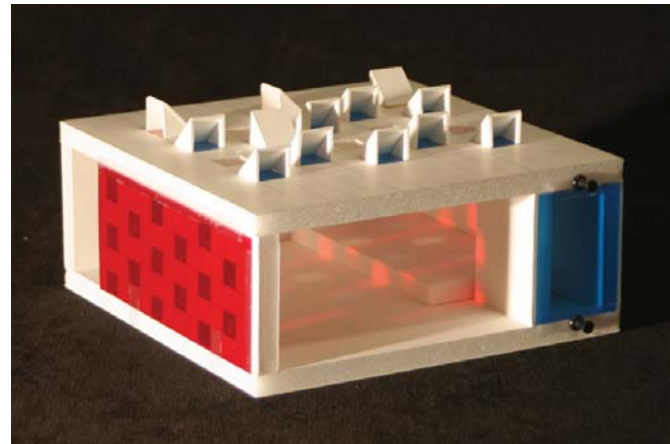
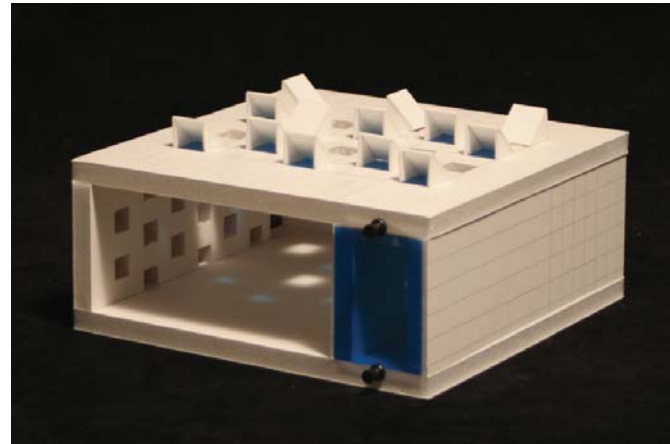

Interior

The support structure of the building is concrete and uses different casting technologies as well as casting surfaces to reflect the wide range of this material. The concrete retains its cold, hard, and rough character when you touch it, but built-in wood furniture creates a material contrast to the concrete so that both materials can be experienced in relation to each other. When children scan their environment, they observe it with their eyes, they smell it with their nose, even taste it occasionally, they touch it with their body and they hear the birds when they sing. An important part of the learning process is playing. By playing children will understand not only the physical environment but also how to socialize in a group. However, there are also moments when they need their own space, a place where they can hide away from the busy active environments of a pre-school classroom. The classroom and especially the built-in furniture can satisfy all of these needs. The main part of the built-in furniture is the central element which includes the changing space and the stairs to the mezzanine level. These two functional elements are designed with features like holes and different smelling wood types to activate the sense of play and discovery in the children. The furniture also has many hiding places which make the whole object like a 3D-Maze. The middle-age and older age group even have access to little bridges which lead to smaller furniture boxes.

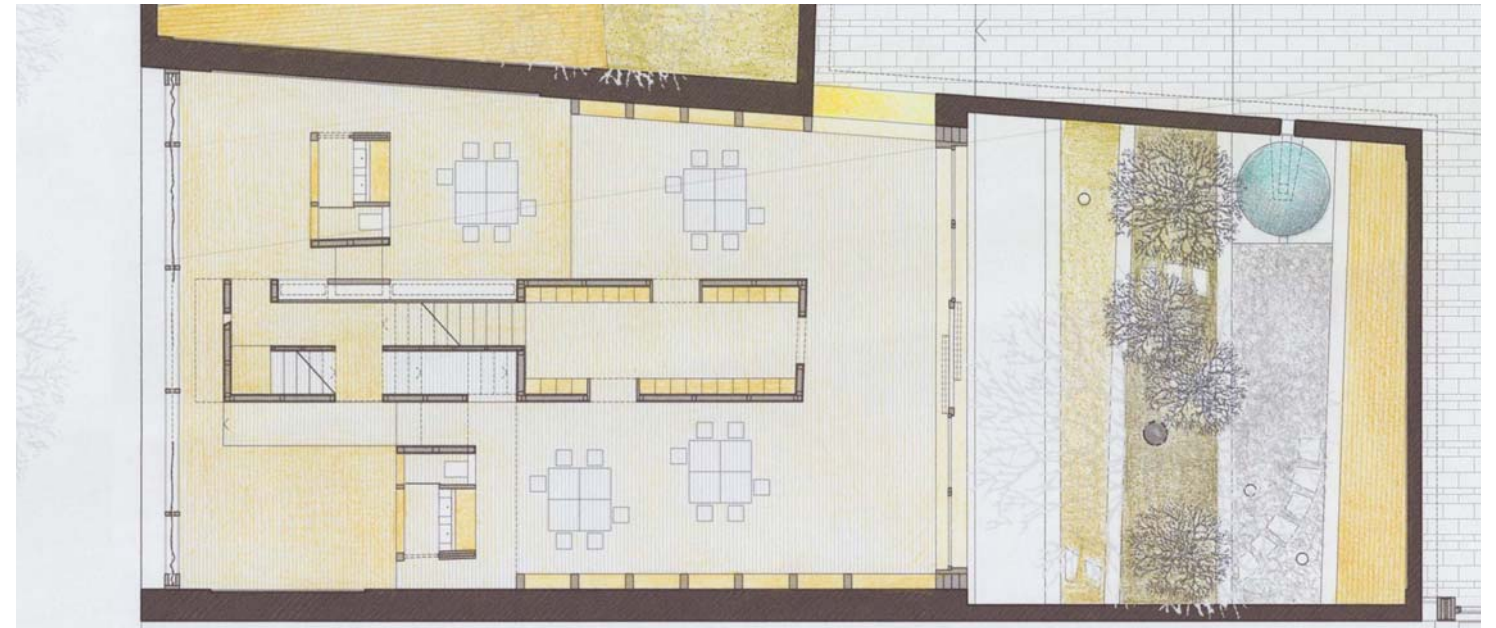

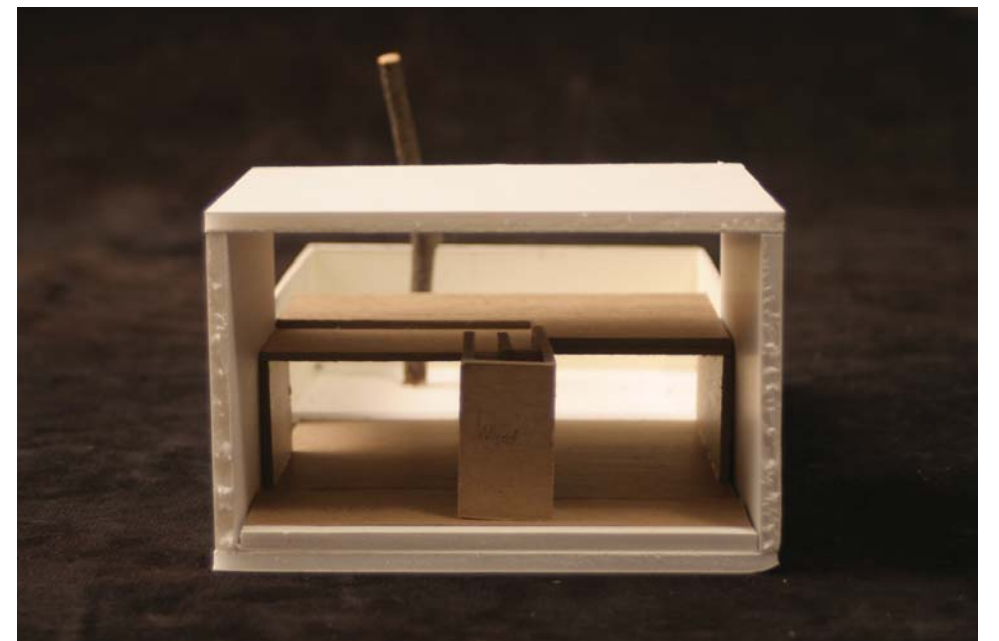
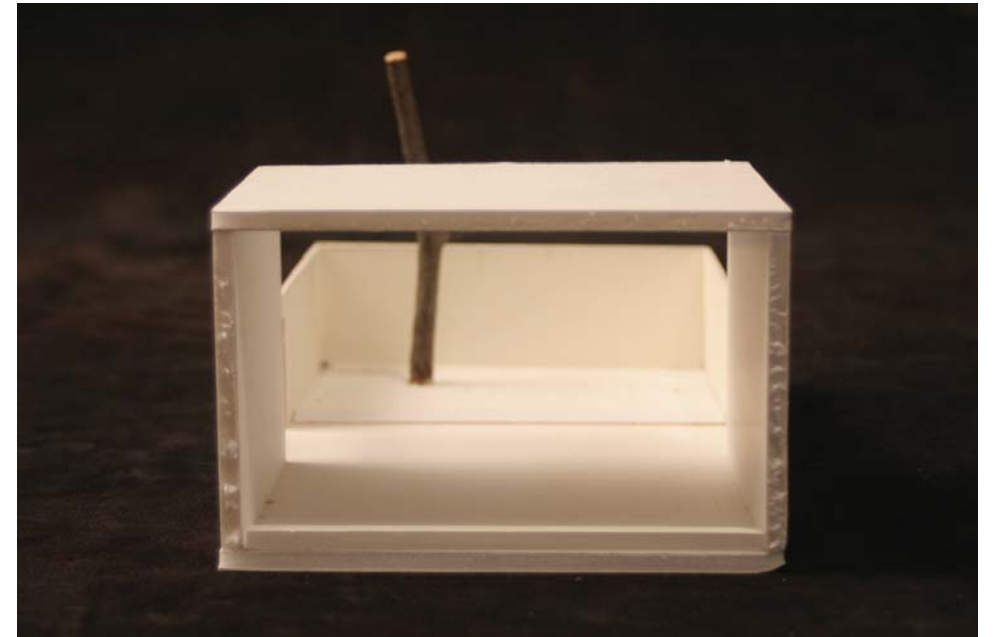
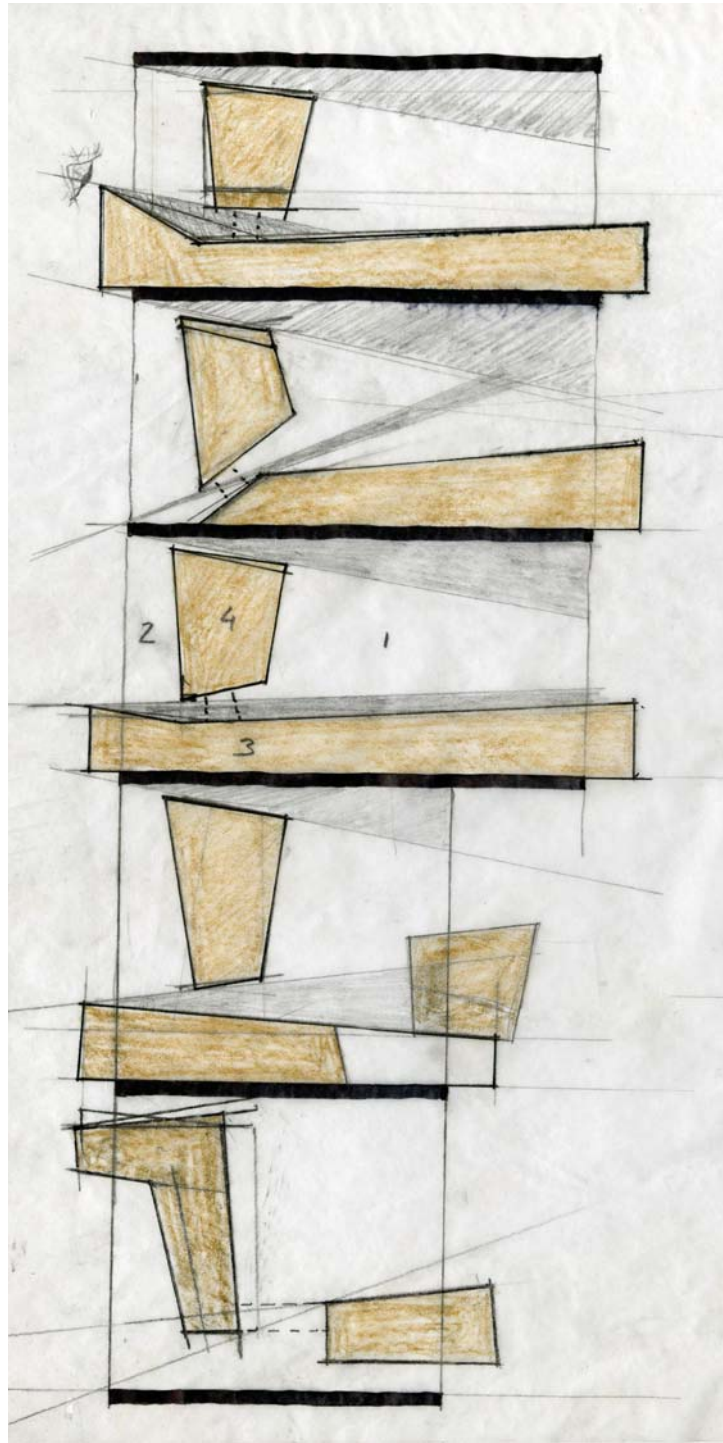
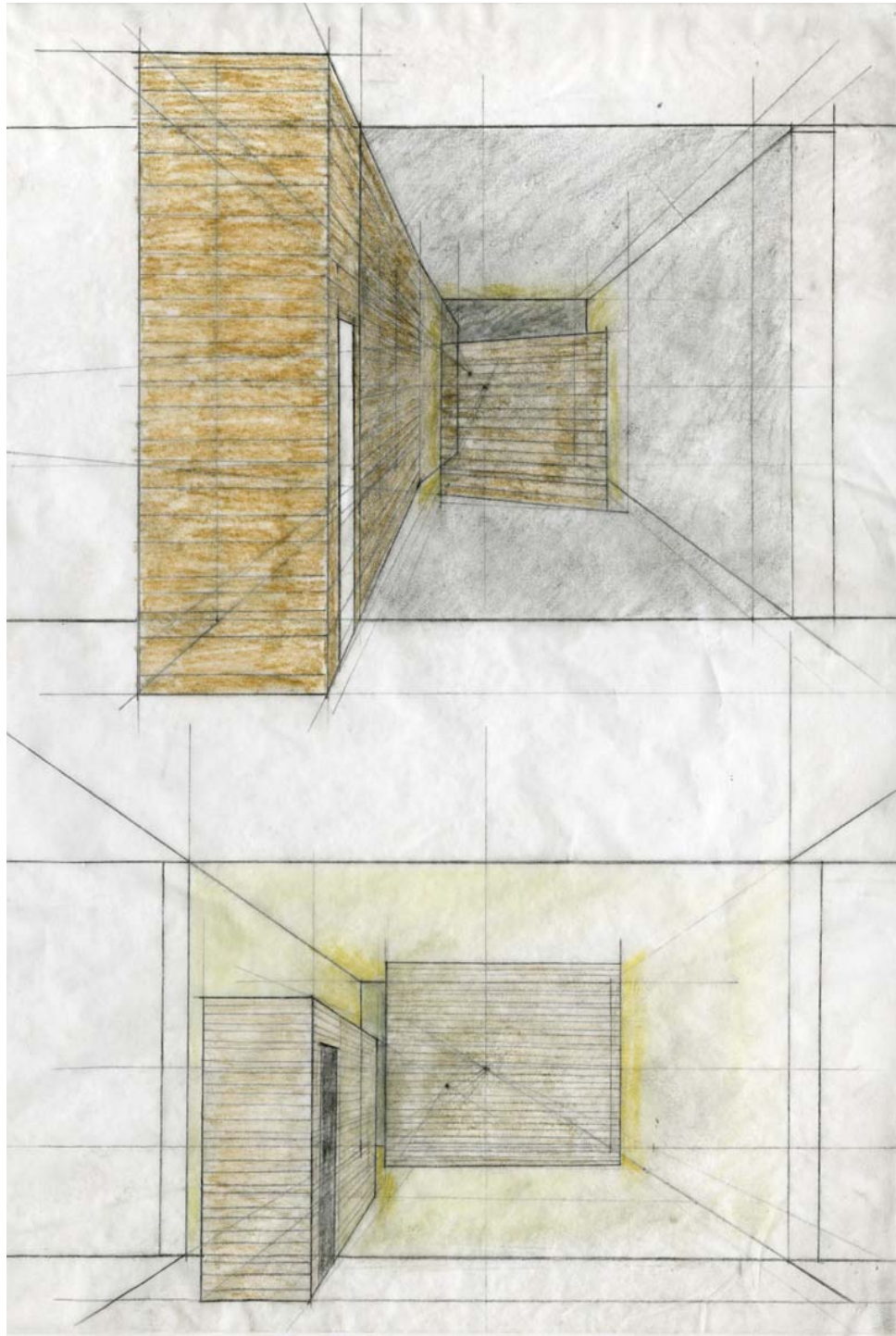

The building design also included a study of the light conditions for the different seasons. The big show windows on the outer façade and the mezzanine windows are big enough to let plentiful daylight inside the classroom all year. During the winter the lower sun will flood the rooms with light, especially in the usually gloomy morning and afternoon hours. During the summer the roof structure protects the inside of the classrooms from the high, hot summer sun.

Additional sun and visual protection for the large two-story windows is provided by a translucent colored curtain. After lunch when the children take a nap break it can be closed and change the room into a cozy space.

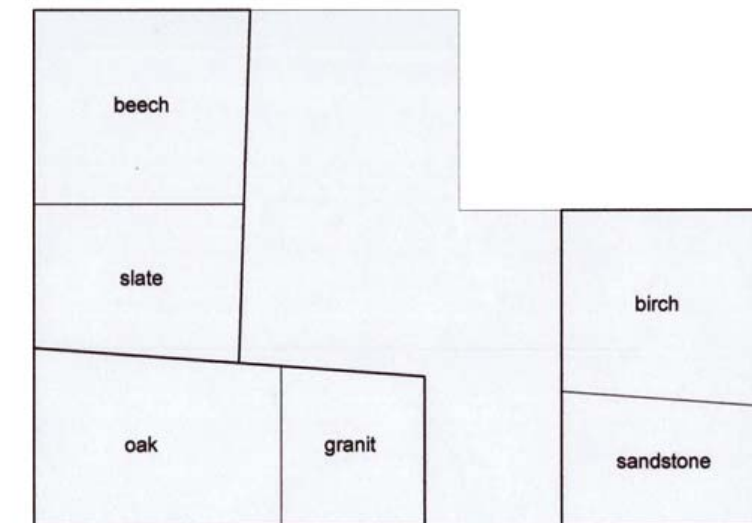
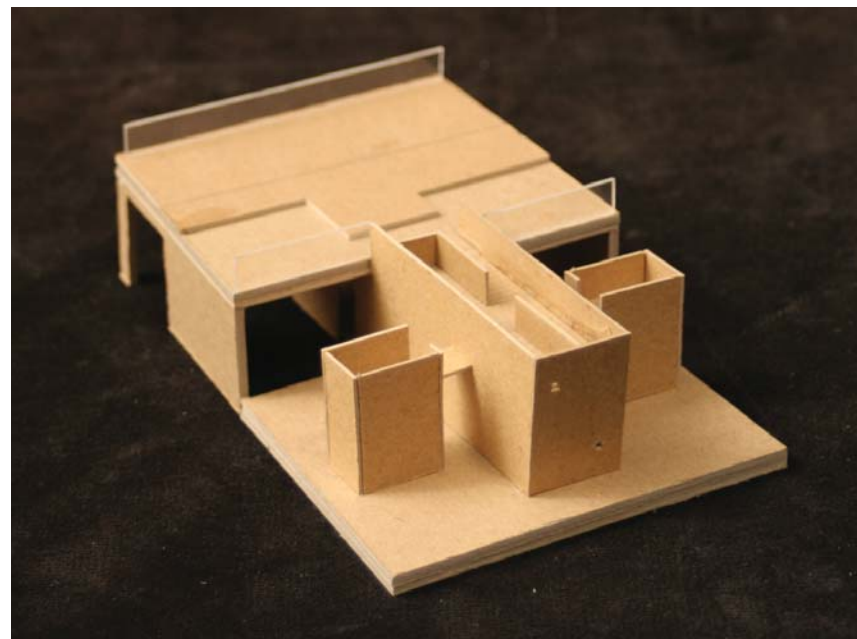
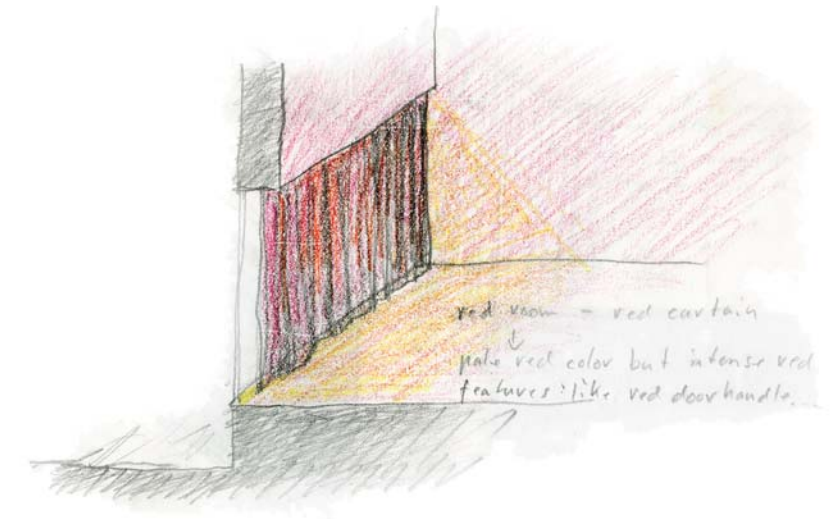

material concept

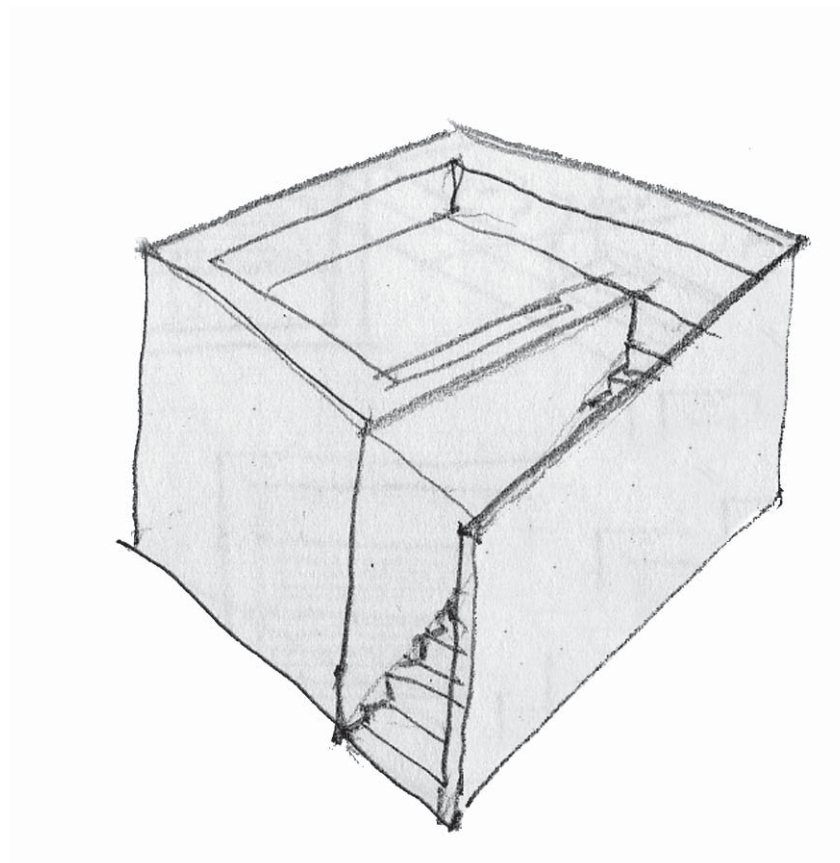
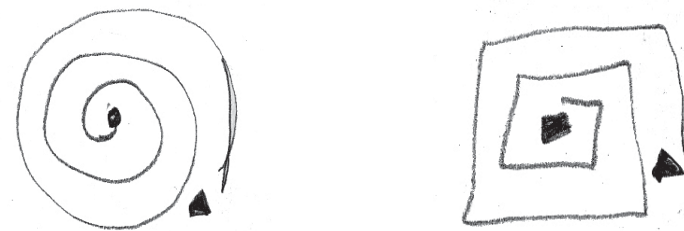
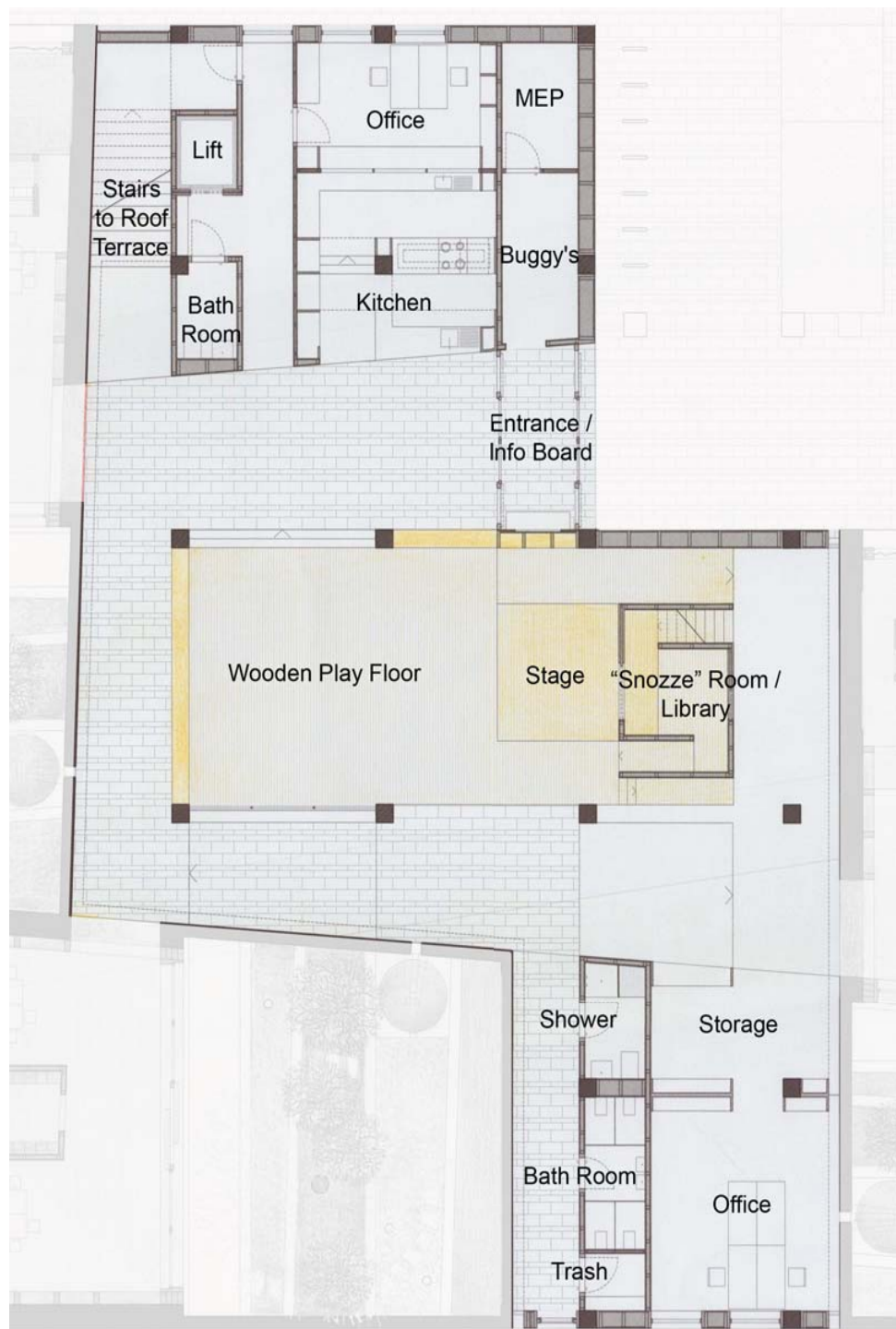

The common room includes built-in furniture too. The room has a wooden box slightly off-centered where children can run around and play hide and seek. The box itself has different functions. It is part of a stage and can be used for all kinds of performances. Behind the stage is a “snooze” room which can be used for play but also for relaxing exercises or reading. Hidden on top of the box is a children’s library which gets natural light through skylights. The level change uses the different building and site conditions to animate the children for different kinds of play and wakes their creativity. A sound system and a projector with a flexible screen can be used for educational and entertaining purposes. Functional rooms like bathrooms, showers and offices are right next to the common space area. The kitchen design allows for child and teacher to cook together. Therefore, one side of the center counter is lower than the other side. The oven is built into the counter and windows on both sides allow children to follow the baking process.

Besides differentiations in material use and classroom totems (specific kinds of pets who are linked to the specific age groups), each unit has also a special color as its identification symbol. The color idea is based on the light-daytime concept of the common room and has therefore blue variations for the young age group, red for the middle age group and yellow for the oldest group. The threshold of each classroom unit is its specific color. Also the interior exposed concrete surfaces show a soft layer of this color. The color level in the concrete is not very high so that the color appears almost transparent and not overwhelming. Small details like hooks or handles use the same color in full saturation. This is important and necessary for children since they need a full color saturation to indicate it. The younger children especially need this clear information since they are just beginning to understand different color ranges.

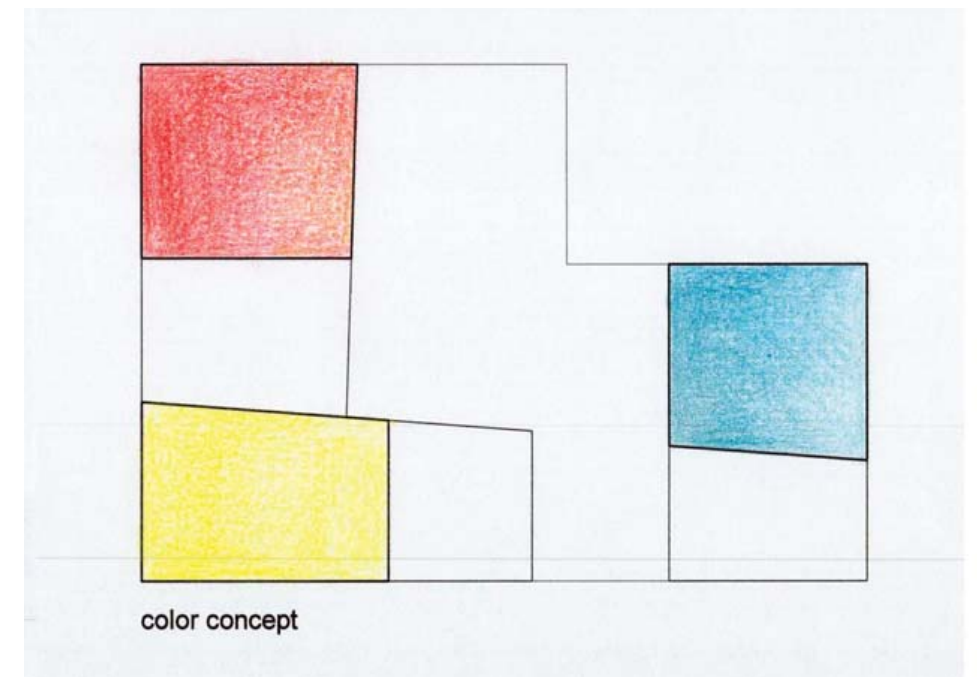

The Gardens

The classroom gardens are visually and spatially connected to the interior classroom areas. Large slighting glass doors support this idea in visual as well as functional terms. Based on the whole classroom concepts the gardens are all similar in their basic design but have differences in their detail finishes. The material range changes from sandstone, to slate, to granite. The garden is divided into strips with different materials. Concrete curbs separate the different strips. The first strip is a concrete slab. The next two strips have different kind of grass, followed by a cobblestone bed which includes different kinds of water features for the summer months. The last strip has grass again and a wooden platform which can be used for performances or as a meeting point.

Depending on the weather the slighting doors can be opened and bring the fresh air, the smells, and the sounds from the garden inside the classroom. Natural air circulation is possible when the upper parts of the show windows and the mezzanine doors are opened. During the summertime the tree leaves provide shade to the garden and make this place a comfortable place, and the cool air from the garden can be used to cool down the classroom as well.

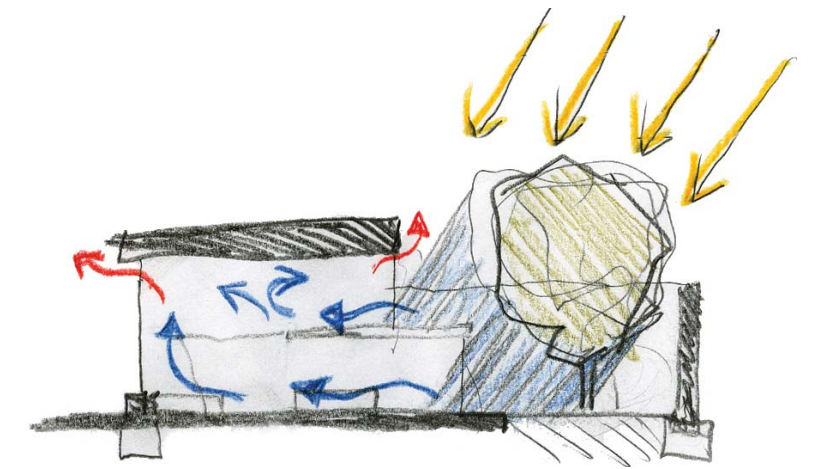

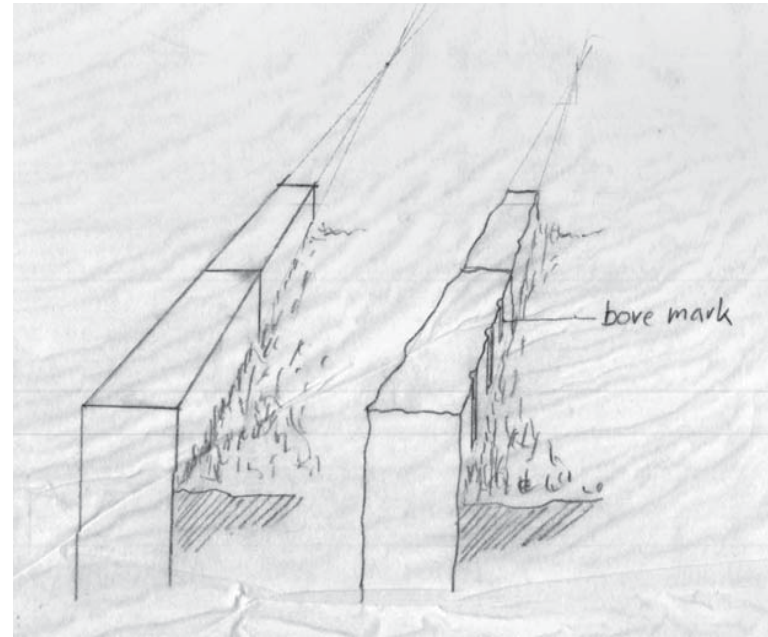
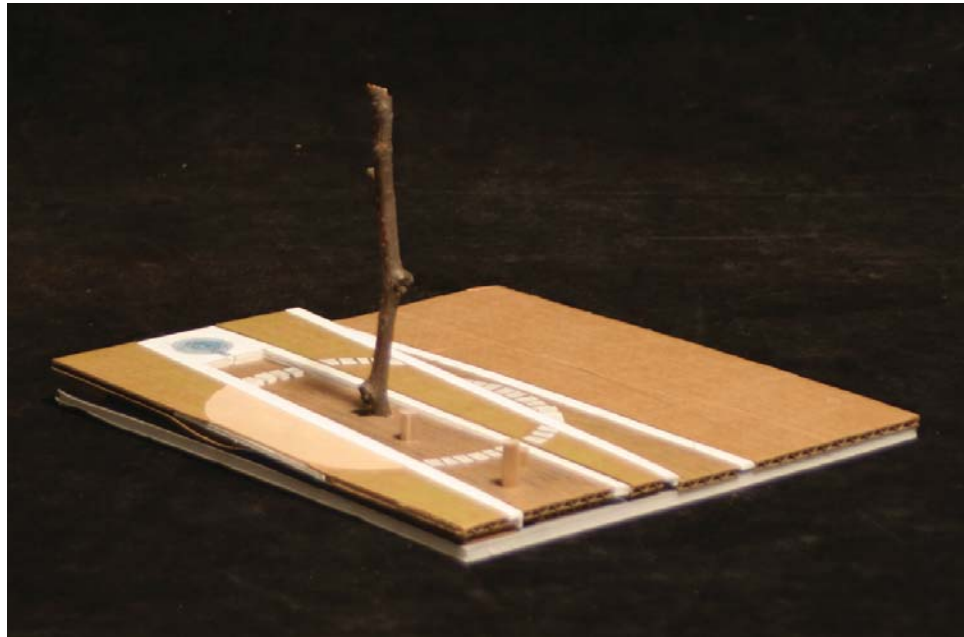

For symbolical and functional reasons each garden has a grand tree. All the trees are almost centered and provide cool shade during the summer heat. Stepping stones arranged in a circle around the tree trunk emphasize the existing and the symbolical meaning of the tree. The stepping stones are also inviting for playing or counting. The concrete curbs which divide the different strips have almost the same function. They also define a level change between the strips and invite one to jump and try balance exercises. Lined up next to the grand tree are five to six smaller trees which have branches just about one foot above ground floor level. They work like a natural layer and space definer. They also offer children the possibility to “climb” and be detached from the ground even though they can climb no higher than several inches.



The Roof Terrace

The roof of the pre-school building defines the roof terrace and is one of the most important places. It offers enough space for play activities or open air events like summer festivals. The children can see their environment from a different level and discover things which they wouldn't with an outdoor garden at ground level. All these facts support the educational program of the pre-school. The common part of the roof terrace has an enclosed shape to define its protected play area. The main materials are wood, stone, and concrete. The roof terrace and the classroom roof also have an extensive vegetation which provide ecological, educational and functional benefits. A green roof will collect and store the water during and after a rain shower. It will create humid and cleaner air. The new ecosystem will provide a new environment for small animals, and will protect the interior space against sound emission and temperature changes.

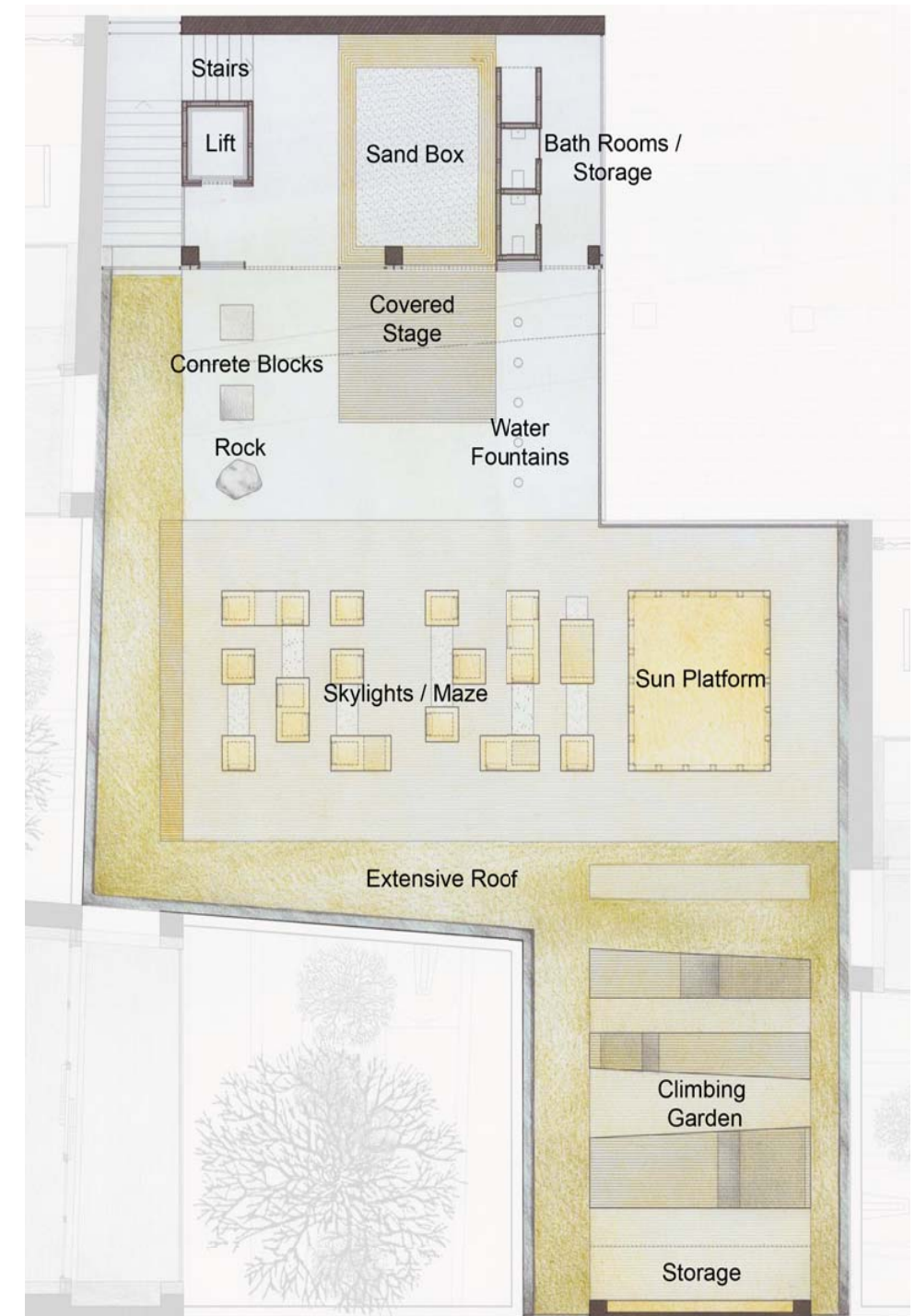
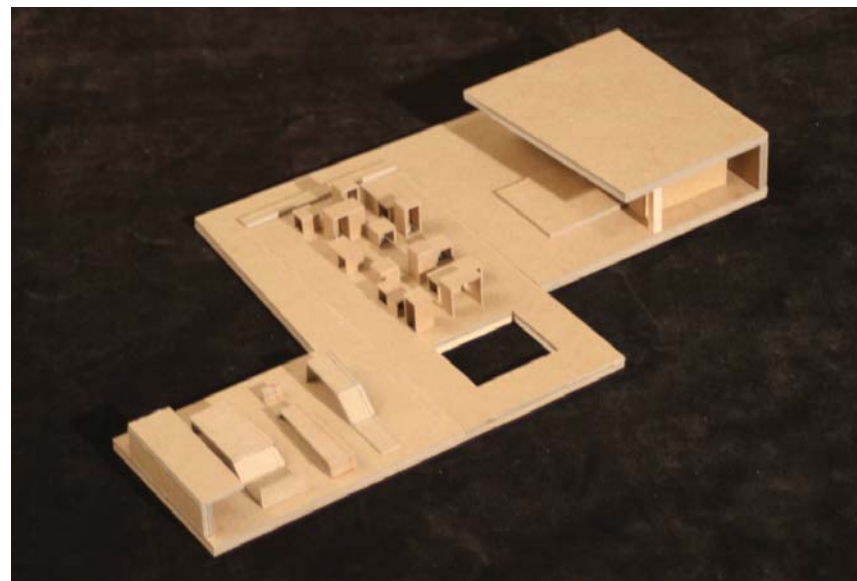
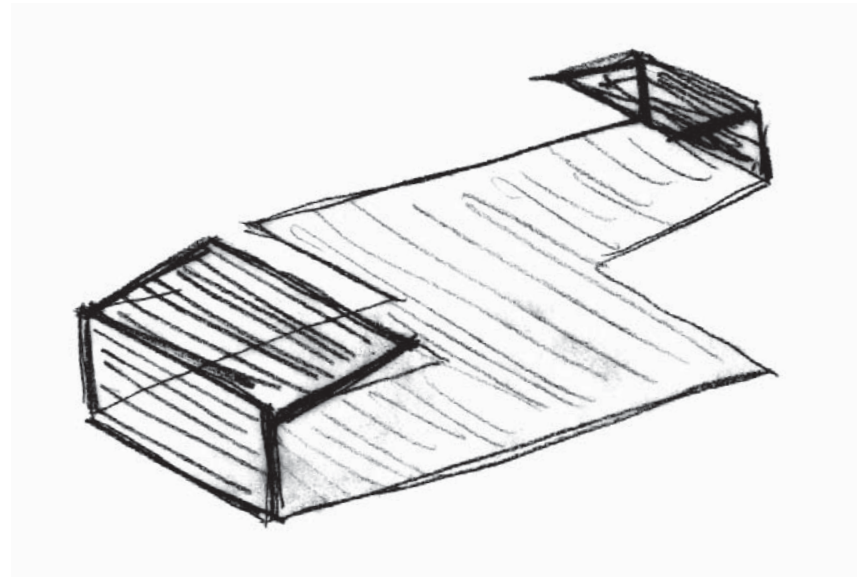

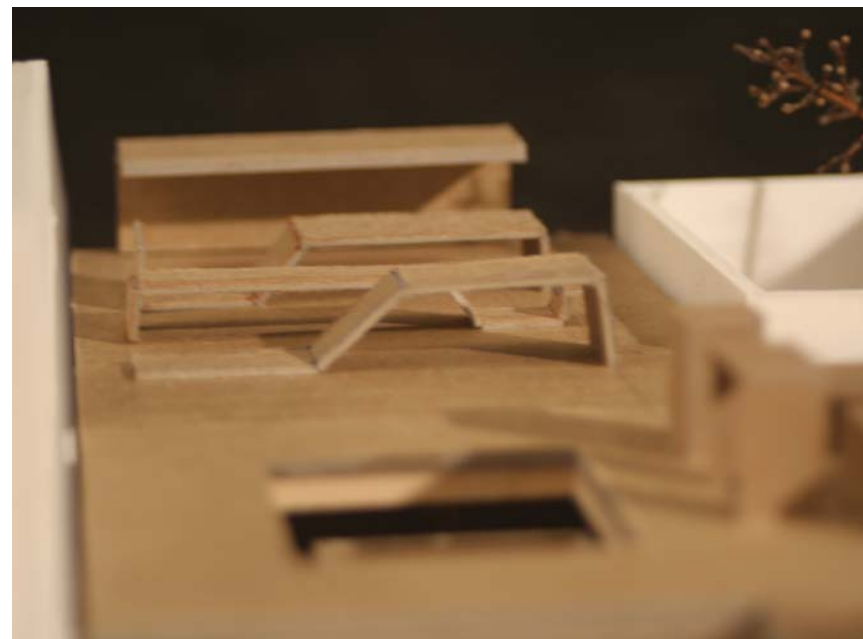
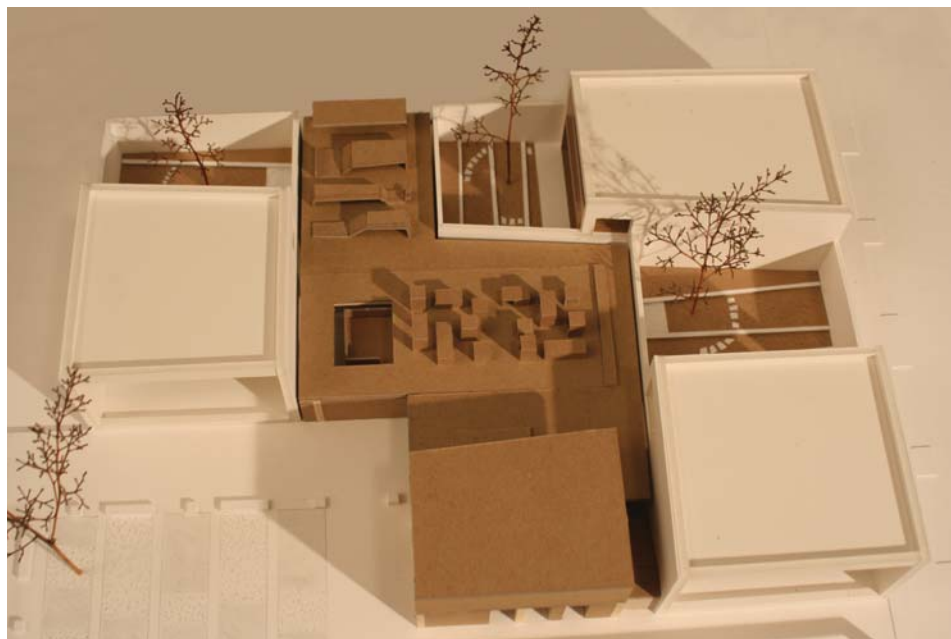

The roof terrace is defined by the outdoor space as well as by an indoor area. The inside part includes a sandbox, bathrooms, and a storage room for toys and tools. An elevator and stairs connect this space to the common space on the ground floor level. The stairs include grate structure for collecting sand from the children shoes when they go downstairs again. Sliding glass doors can open up the room completely to the outdoor area.

The outdoor area has a stage, a labyrinth, and a small climbing garden. The stage area includes different sculptural objects like a concrete block, a natural rock, and water-sprayers for the hot summer days. The labyrinth is created by the top parts of the skylight of the common room. The structures are tall enough for hide and seek but won't minimize the observer level of the teachers. The labyrinth has floor areas with different materials like cobblestones, gravel, and small colored glass balls. The different materials make different noises when you step on them and sharpen acoustic perception. The climbing garden has objects with little slopes, caves, lower, and higher parts and an additional storage area provides space for outdoor equipment.

When the extensive green roof can not longer hold rain water it will release the water into gutters which lead to three gargoyles. Each spout releases water into one of the three gardens where it will be collected in a concrete basin. Vertical windows in the common space wall emphasize the fascinating natural event of falling water and its ultimate splashing on the water surface when it rains. If the basin overflows it will dispense the water to the garden on the ground floor level.

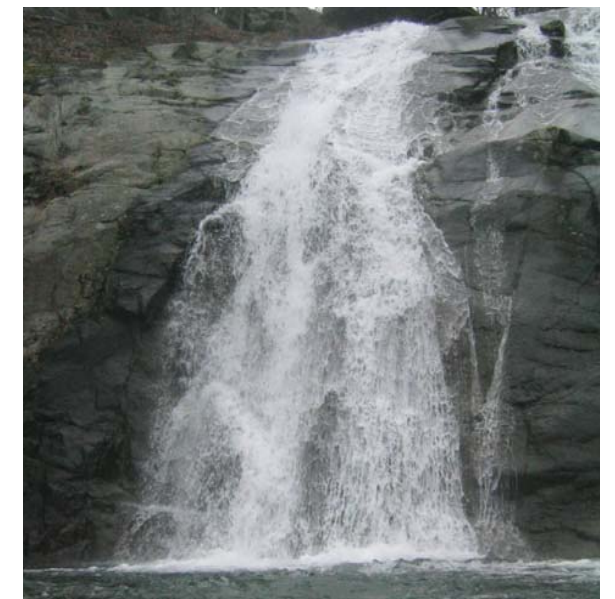
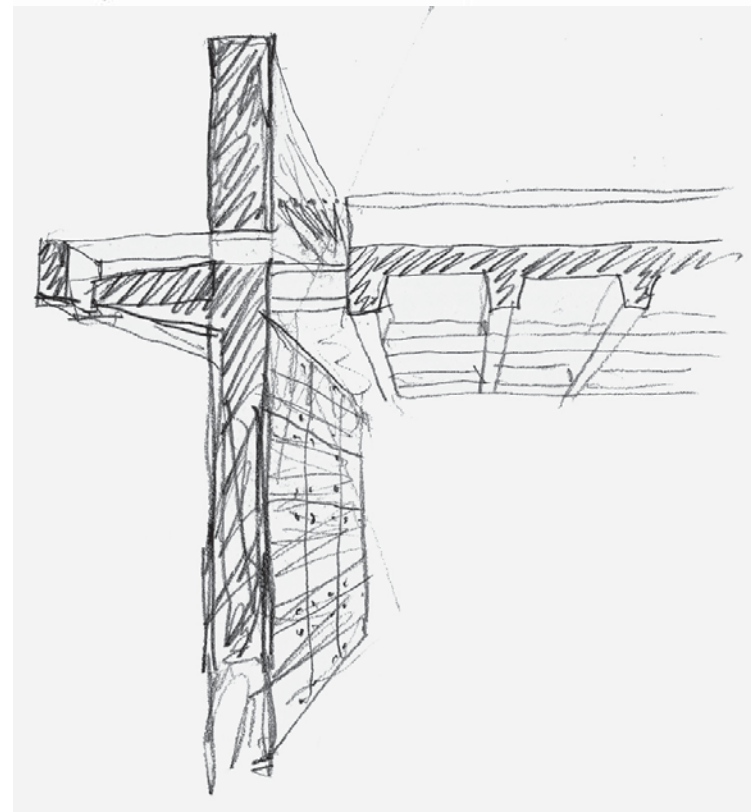
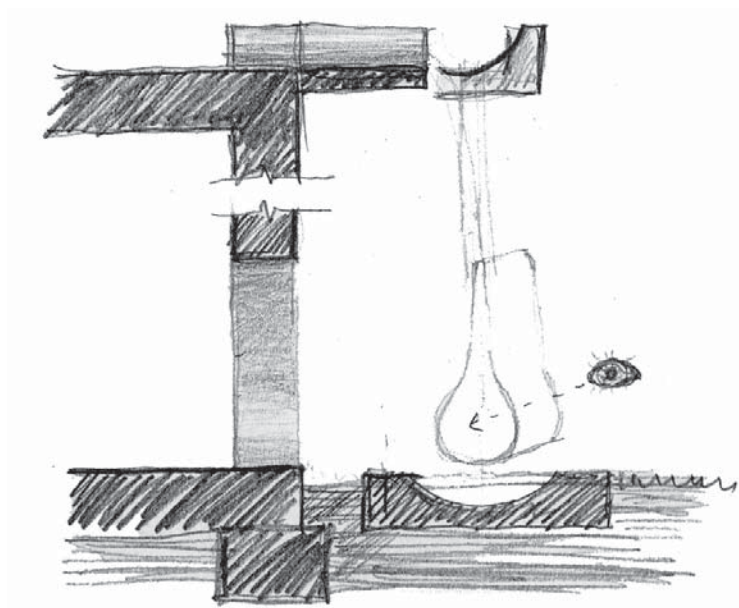

Final Project: A Pre-school in Old Town Alexandria

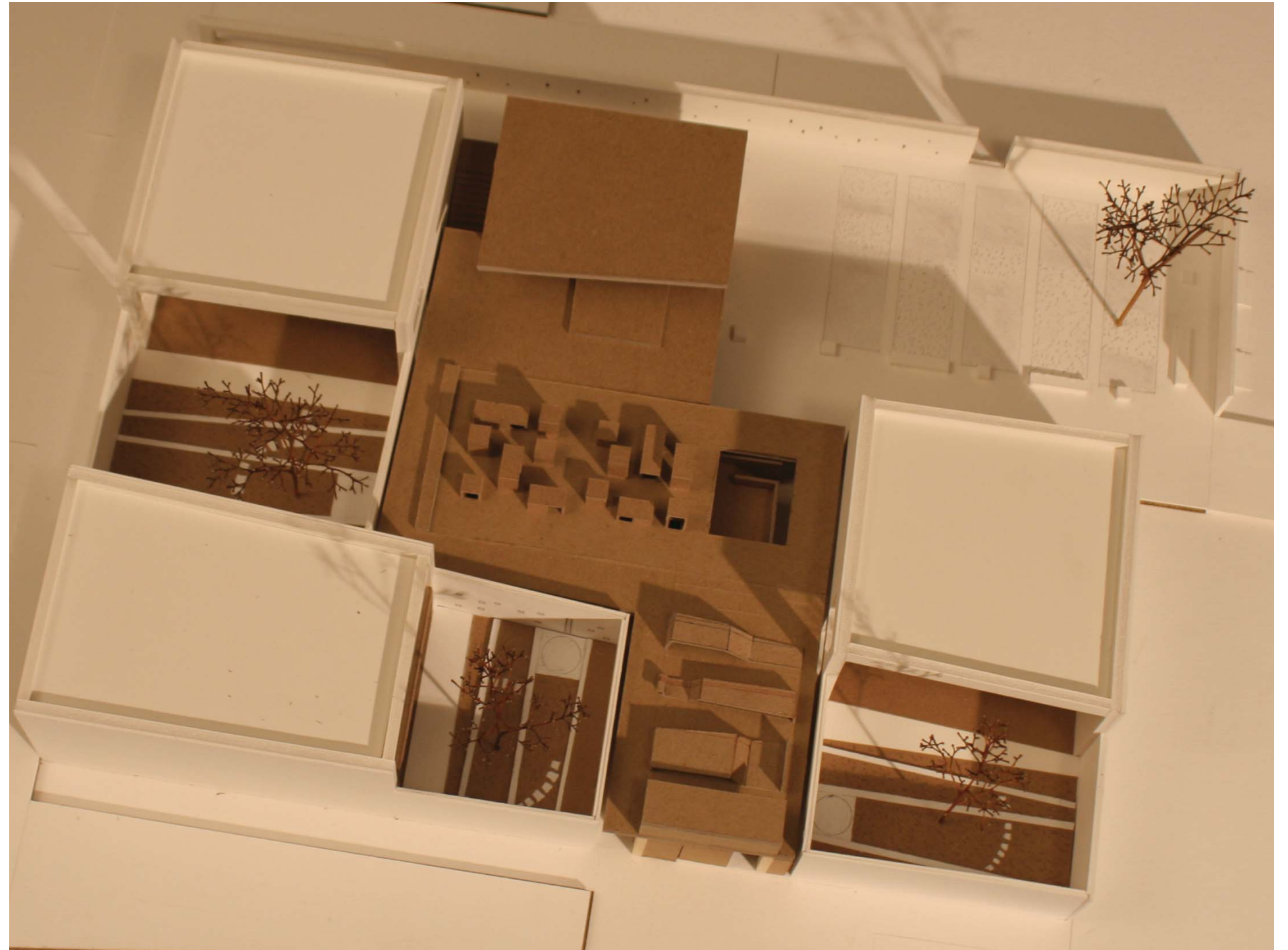

Site Plan and Site Model



Plan Drawings

Ground Floor Level



Roof Terrace Level



Classroom Section





Common Room Section



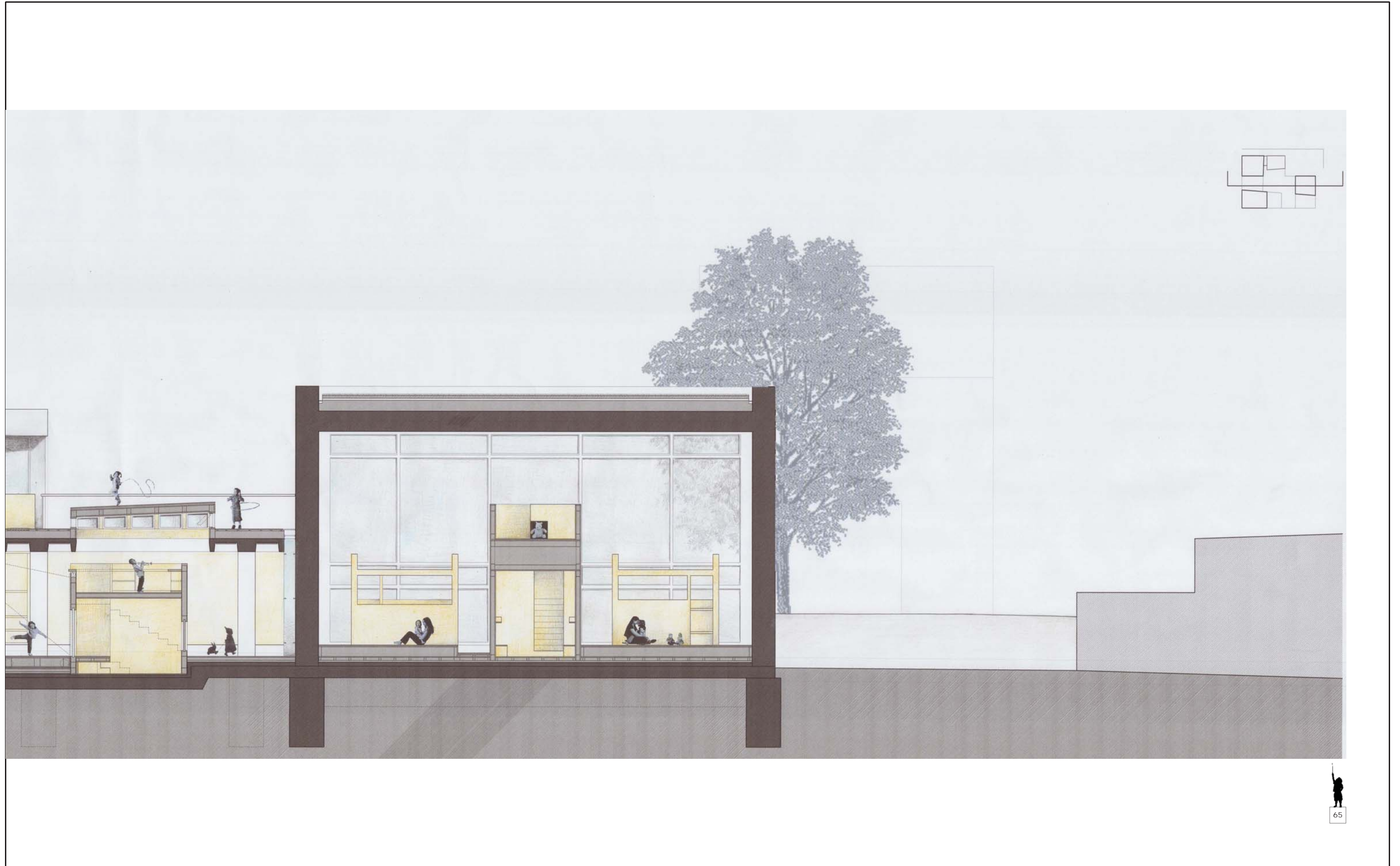

North Elevation



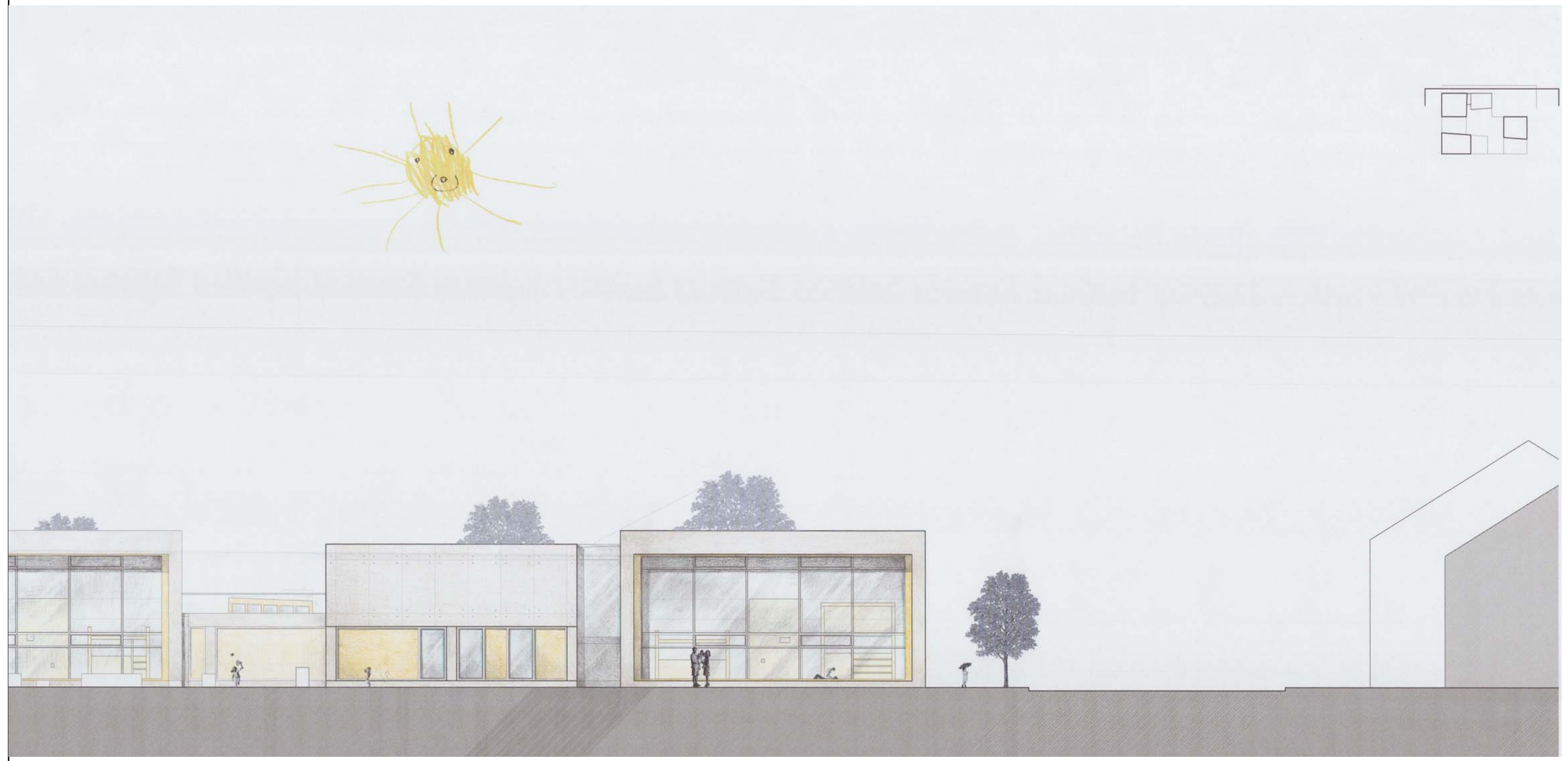
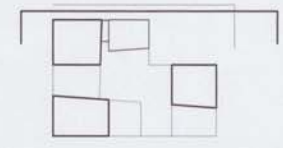

North Elevation



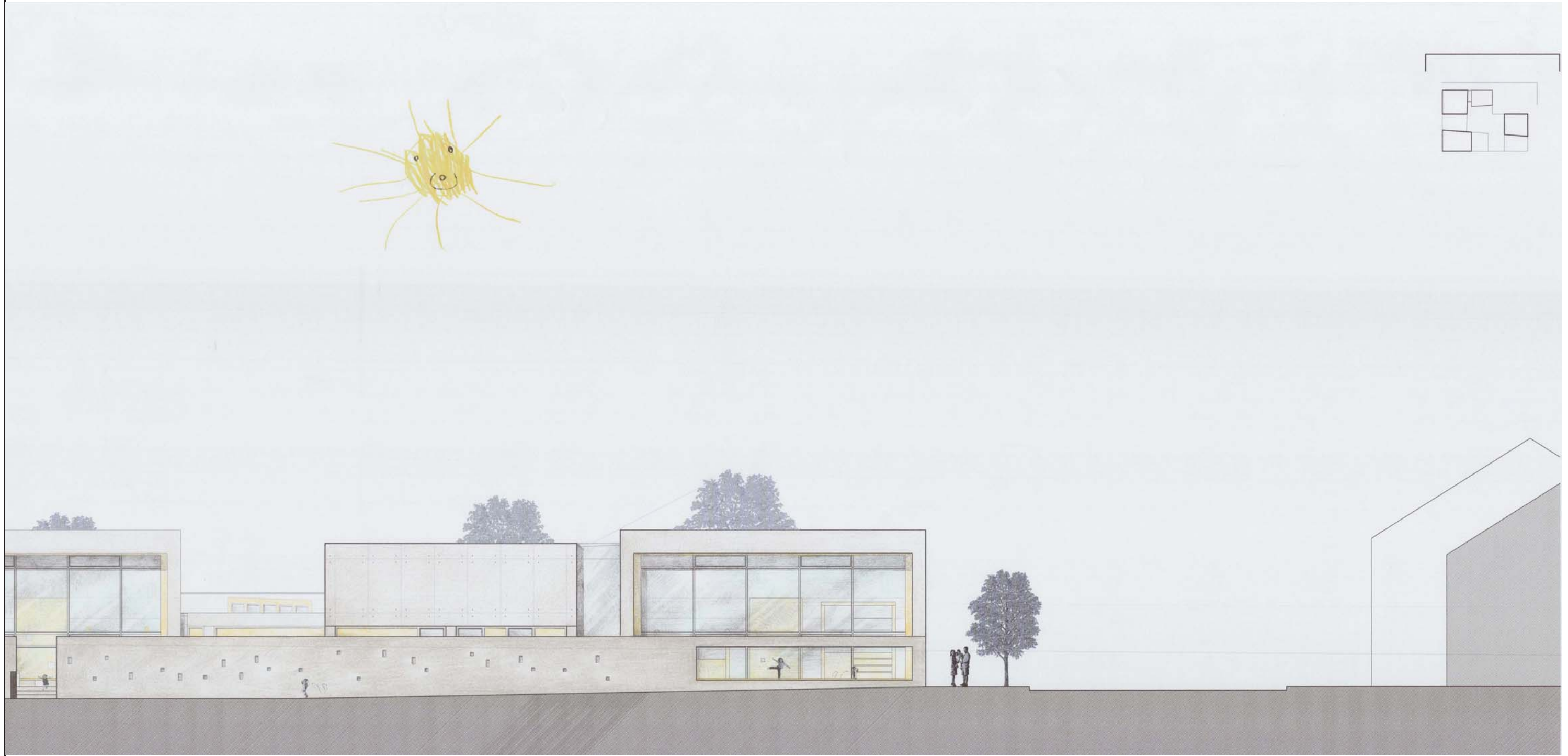
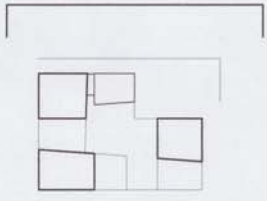

East Elevation - Pitt Street

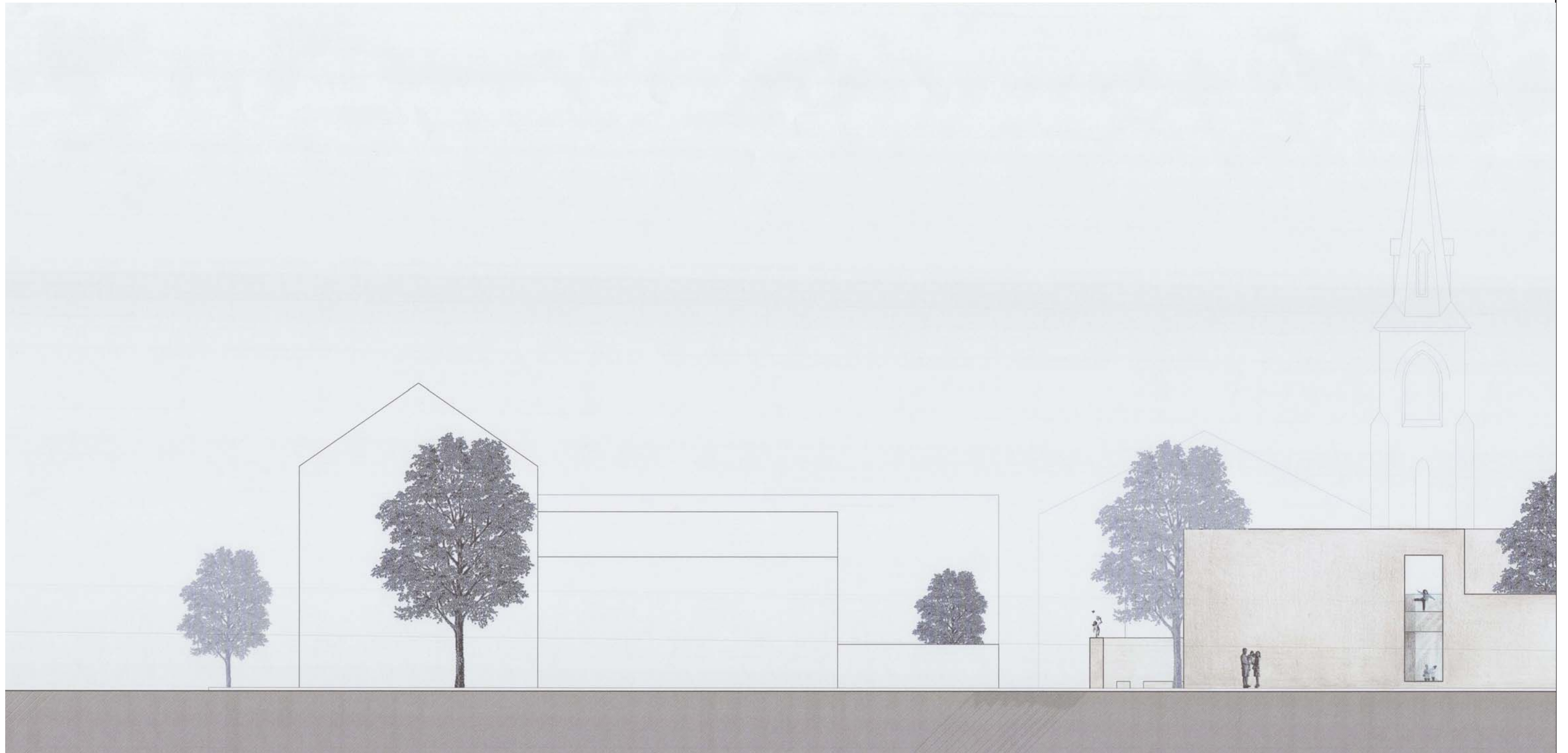

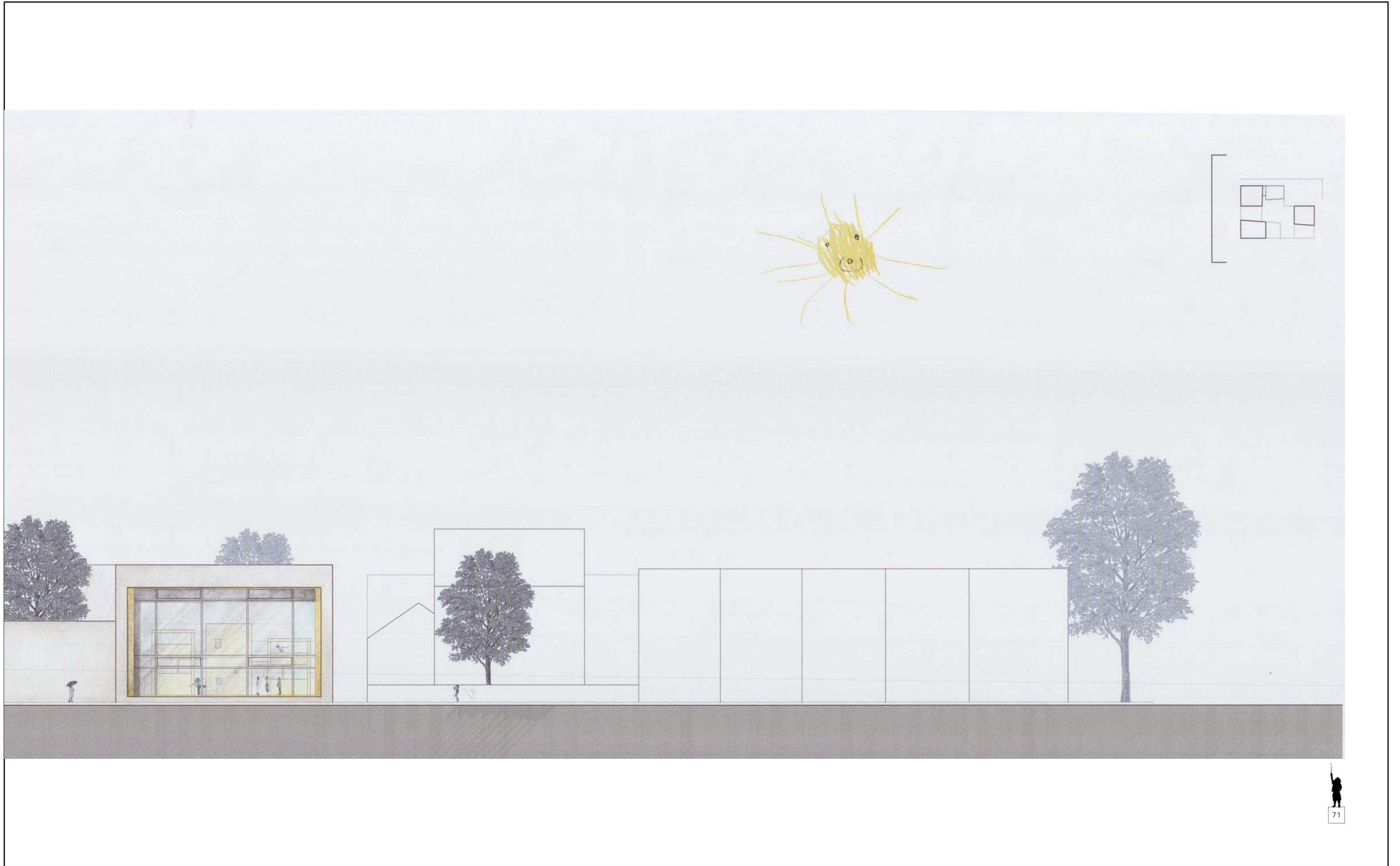

Common Room - West Wall

Morning

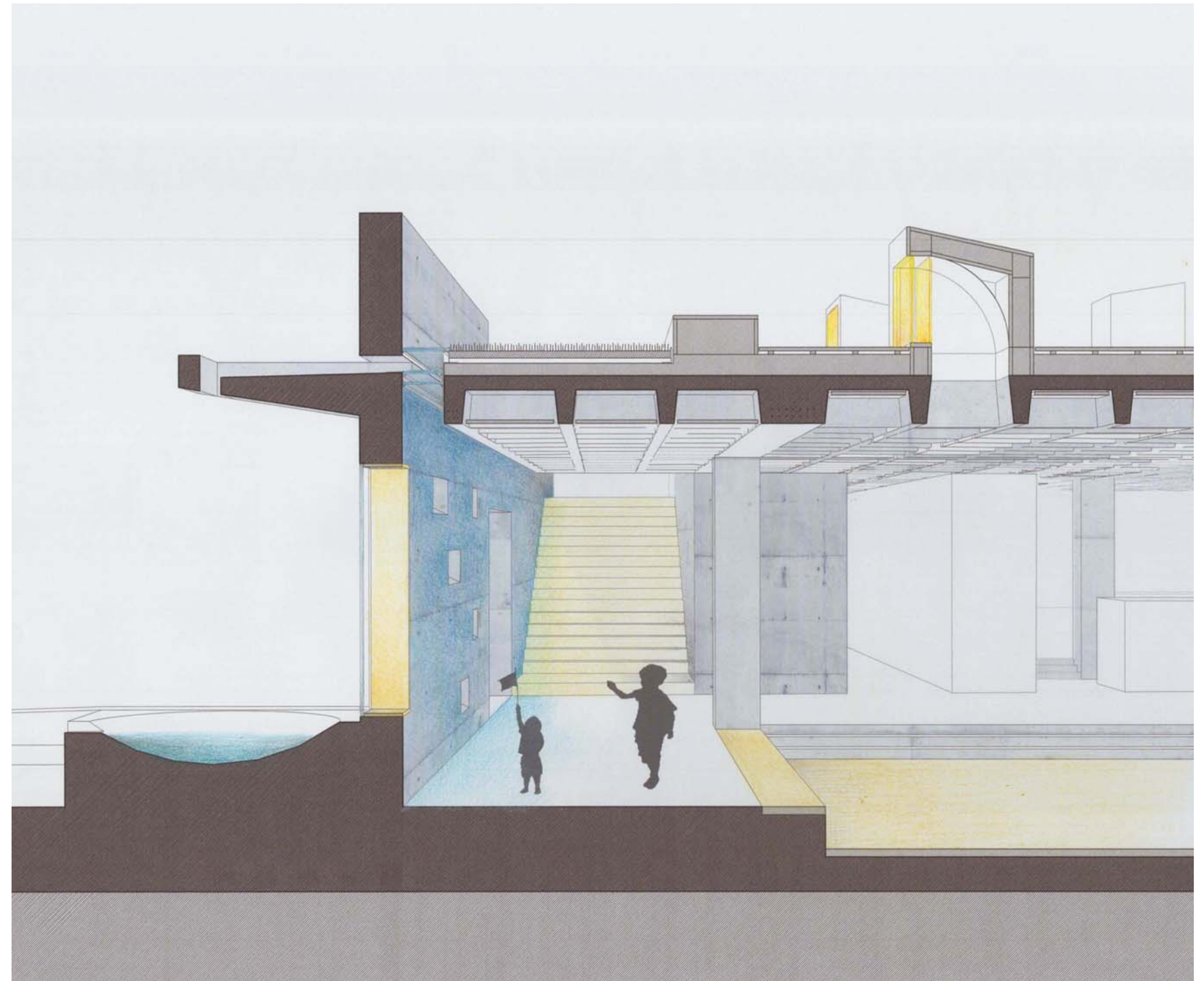

Common Room - West Wall

Afternoon

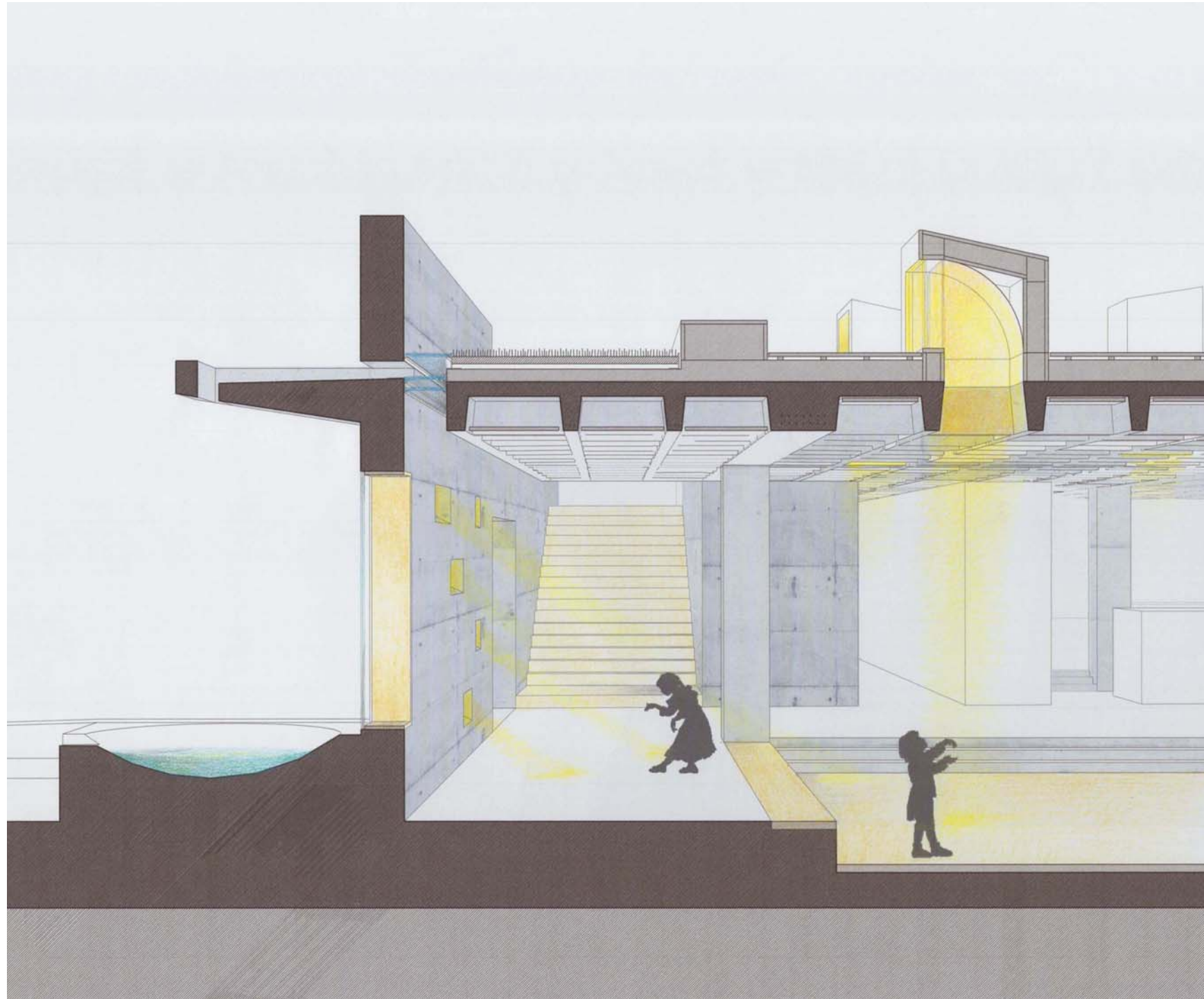

Roof - Gargoyle Detail

- 1 Soil
- 2 Concrete foundation / slab
- 3 Waterproof membrane
- 4 Wood floor with insulation
- 5 Wood seat
- 6 Wood framed window
- 7 Laminated and insulated glass with yellow transparent film
- 8 Single glass with blue transparent film
- 9 Laminated and insulated glass
- 10 Acoustical wood panel fastened to reinforced concrete waffle ceiling
- 11 Concrete beam with reinforcing
- 12 Insulated roof structure
- 13 Waterproof membrane
- 14 Drain layer and drain mat
- 15 Extensive green roof with light weight soil, water semi permeable membrane and drain mat
- 16 Wood roof decking
- 17 12" Structural - Insulating Concrete
- 18 Stainless steel cable as drainage guide
- 19 Water pond in classroom garden
- 20 Grill - stainless steel
- 21 Wood framing for bench, Pressure treated

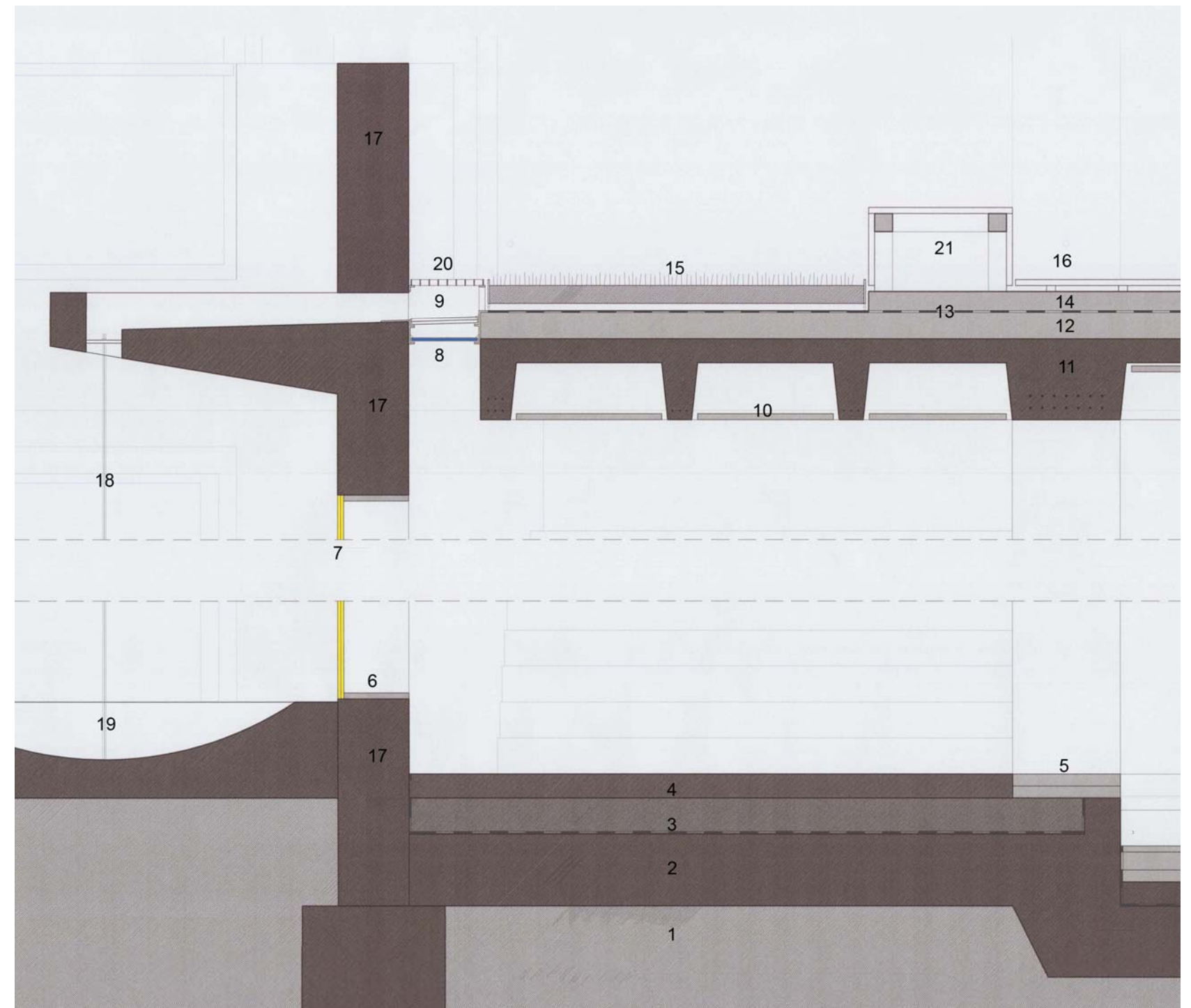

Roof - Skylight Detail

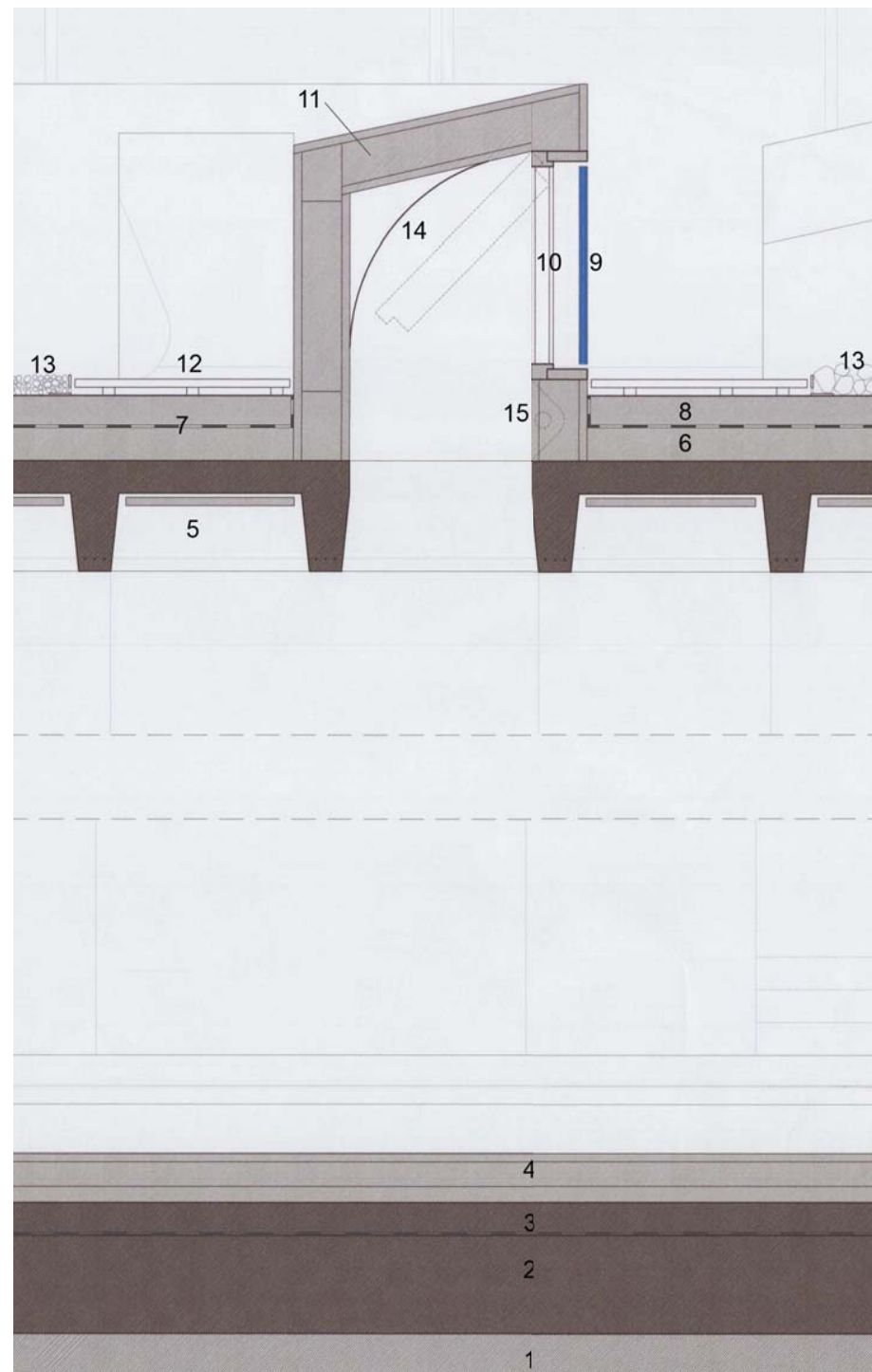

- 1 Soil
- 2 Concrete foundation / slab
- 3 Waterproof membrane
- 4 Wood floor with insulation and radiant heating
- 5 Acoustical wood panel fastened to reinforced concrete waffle ceiling
- 6 Insulated roof structure
- 7 Waterproof membrane
- 8 Drain layer and drain mat
- 9 Laminated glass with blue transparent film
- 10 Window with tempered and insulated glass
- 11 Wood framing with insulation
- 12 Wooden roof decking
- 13 Tactile Elements - Beds with cobble stone, glass balls, sand, grass
- 14 Polished steel sheet; curved
- 15 Light fixture

Conclusion

The role of education is one of the most important elements in our society.

Although human beings continuously learn through their experiences and impressions, the most important years in determining all the actions and decisions which will be made later in life are during their childhood.

Architecture has in this case a very important role since it is a relevant part of our environment. It influences us from the beginning of our life and creates the background for our social, cultural, economical education.

Therefore, architecture has not only the duty to create functional and well designed spaces but also to provide possibilities to animate human instincts and habits by interacting with all of the human senses.

To reflect my work from a different person I would like to end my book with a quote from Peter Zumthor.

“We all experienced architecture before we have even heard the word. [...] The roots of our architectural understanding lie in our architectural experience: our room, our house, our street, our village, our town, our landscape, - we experience them all early on, unconsciously, and we subsequently compare them with the countryside, towns, and houses that we experience later on. The roots of our understanding of architecture lie in our childhood, in our youth; they lie in our biography.”¹

¹ Zumthor, Peter; “Thinking Architecture”; Birkhaeuser, 2. expended edition; pp. 65



References

Becker, Gerald; Bilstein, Johannes; Liebau, Eckart	Räume bilden. Studien zur pädagogischen Topologie und Topographie, Kallmeyer (Dez. 1997)
Bognar, Botond	Kengo Kuma: Selected Works, Princeton Architectural Press; 1 edition (March 1, 2005)
Brosterman, Norman	Inventing Kindergarten, Harry N. Abrams, Inc. (24. April 1997)
Ching, Francis D.K.	Architecture: Form, Space, and Order, Wiley; 2 edition (January 1, 1996)
Forster, Johanna	Räume zum Lernen und Spielen. Untersuchungen zum Lebensumfeld 'Schulbau', Verlag für Wissenschaft und Bildung, Berlin (September 2000)
Hicklin, Alois	Das menschliche Gesicht der Angst, Kreuz; 1. Aufl edition (1989)
Kahn, Louis I. ; Buttiker, Urs	Louis I. Kahn: Light and Space - Licht Und Raum, Birkhäuser (December 1993)
Lyndon, Donlyn	(1985) "Caring About Places", Places: Vol. 2: No. 1 Article, http://repositories.cdlib.org/ced/places/vol2/iss1/Lyndon
Neufert, Ernst	Architects' Data by Publisher: Blackwell Publishers; 3rd edition (September, 2002)
Pallasmaa, Juhani	"The Eyes of the Skin: Architecture and the Senses"; Academy Press; 2nd edition (June 17, 2005)
Ramsey, Charles George	Architectural Graphic Standards by Publisher: Wiley; 1 edition (April 15, 2000)
Riera, Oscar Ojeda	Architecture in Detail: Colors, Rockport Publishers (November 1, 2004)
Riera, Oscar Ojeda	Architecture in Detail: Elements, Rockport Publishers; New Ed edition (March 1, 2005)
Riera, Oscar Ojeda	Architecture in Detail: Materials, Rockport Publishers (April 1, 2003)
Riera, Oscar Ojeda	Architecture in Detail: Spaces, Rockport Publishers (November 1, 2004)
Rubin, Jeanne S.	"The Froebel-Wright Kindergarten Connection: A New Perspective", The Journal of the Society of Architectural Historians, Vol. 48, No. 1 (Mar., 1989)
Zumthor, Peter	"Thinking Architecture"; Birkhaeuser, 2nd expended edition
Deutsche Bauzeitung (Publisher)	db 01-2006, Oberflächen anderes, page 68, page 82
Deutsche Bauzeitung (Publisher)	db 10-2005, Umnutzung, page 34
Deutsche Bauzeitung (Publisher)	db 03-2007, Wohlfühlen, page 64, page 82
Deutsche Bauzeitung (Publisher)	db 01-2007, Beton, page 18, page 76
Wüstenrot-Stiftung (Publisher)	Schulen in Deutschland : Neubau und Revitalisierung, Stuttgart [u.a.] : Krämer, 2004
Additional Resources:	http://alexandriava.gov/gis/info http://earth.google.com/ http://www.froebelweb.de http://www.wikipedia.org/ http://www.delston.co.uk/greenroofs.htm http://www.etd.vt.edu http://www.tenbyten.net/vegas.html - Urcan, Melissa "Still Learning From Las Vegas: Robert Venturi and Denise Scott Brown take on Sin City architecture three decades later"
Image References:	Pages
	16, 14, 27, 29, 31, 32-34, 37, 38, 40, 40, 44-46, 49, 50, 52, 55-57, 60 Alexandria, Virginia, 11-25-2006 by author
	22-26, 29, 55 Washington Alexandria Architecture Center, Alexandria, Virginia, 06-07-2007 by author
	58 Shenandoah National Park, Virginia, 01-22-2006 by author
	55, 58 San Francisco, California, 12-29-2007 by author
	Cover, ii, 10-78 Unless otherwise noted, all images by author

Vita

Education

08/05 - Spring/08	M.Arch-II at Washington Alexandria Architecture Center, Virginia Polytechnic Institute and State University
09/2004	Diploma of Architecture, mark 1.7 (3.4 GPA)
09/01 - 03/02	Exchange program, Bauhaus - University Weimar and Oxford Brookes University
09/2000	Basic studies degree, Bauhaus - University Weimar
07/1997	Abitur (exit exam), mark 1.7 (3.4 GPA)
1990 - 1997	Wilhelm v. Humboldt Gymnasium, Halle (High school)

Employment

Current (started 07/2007)	CCS Architecture, San Francisco, CA
06-12/2007	Parker-Rodriguez, Landscape Architecture Firm, Alexandria, VA
02-06/2005	BENOY, Architecture Office, Newark, GB
11-12/2004	Manipolazione Internazionale, Architecture Office, IAESTE Work Exchange, Moscow
04-09/2002	BENOY, Architecture Office, Newark, GB
Summer 2001	Practical Training, Haubenreiser und Linden, Architecture Office, Halle, Germany
Spring Term 2001	Practical Training, Mittag+Prax, Architecture office, Weimar, Germany
Summer 2000	Practical Training, Design-Build, Wales,
Summer 1999	Practical Training, building site, Halle, Germany

